

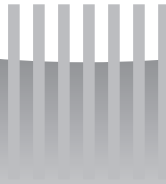

mLAN INTERFACE CARD

# **MY I 6-mLAN**

**Owner's Manual**  
**Bedienungsanleitung**  
**Mode d'emploi**



English

Deutsch

Français

EN

DE

FR

# PRECAUTIONS

## PLEASE READ CAREFULLY BEFORE PROCEEDING

\* Please keep this manual in a safe place for future reference.



### WARNING

Always follow the basic precautions listed below to avoid the possibility of serious injury or even death from electrical shock, short-circuiting, damages, fire or other hazards. These precautions include, but are not limited to, the following:

- Before installing the MY16-mLAN in an audio device please check to make sure that the device is compatible with the MY16-mLAN, and check possible restrictions regarding the maximum number of Yamaha and third-party expansion cards that can be simultaneously installed. Refer to the operation manual supplied with the audio device, and/or the Yamaha Pro Audio web site at: <http://www.yamahaproaudio.com/>
- Do not install the MY16-mLAN card in any Yamaha products not specified by Yamaha for use with the MY16-mLAN to avoid possible electrical shock, fire, or equipment damage.
- Do not attempt to disassemble or modify the card. Do not apply excessive force to card connectors or other card components. Mishandling of the card may lead to shock, fire hazard, or equipment failure.
- Be sure to disconnect the power cable of the main unit before installing this card (in order to eliminate shock hazard).
- Turn off all peripheral devices of the host device before installation and unplug all cables connecting the host device to all peripheral devices.



### CAUTION

Always follow the basic precautions listed below to avoid the possibility of physical injury to you or others, or damage to the device or other property. These precautions include, but are not limited to, the following:

- Do not touch the metallic leads (pins) of the circuit board when handling the card. The pins are sharp and may cause hand cuts.
- Wear a pair of heavy gloves during installation to avoid scratching or cutting your hands on sharp edges.
- Avoid touching exposed connectors and metal parts to minimize the possibility of bad connections.
- Drain all static electricity from your clothing and body before handling the card. Static electricity can damage the card. Touch an exposed metal part of the host device or other grounded object beforehand.
- Do not drop the card or subjecting it to shock, which can cause breakage and/or malfunction.
- Do not drop screws or other small parts inside the card. If power is applied while screws or similar metal objects are loose inside the unit the card may malfunction or be damaged. If you cannot retrieve dropped objects yourself, refer the problem to qualified Yamaha service personnel.

Yamaha cannot be held responsible for damage caused by improper use or modifications to the device, or data that is lost or destroyed.

# Introduction

Thank you for purchasing the Yamaha MY16-mLAN.

The MY16-mLAN is an interface card that features an mLAN interface. mLAN is a digital network designed for music and is based on the IEEE1394 high performance serial bus and data communication protocol. mLAN makes it easy to construct sophisticated networks for IEEE1394 (FireWire/i.LINK) audio and MIDI signals without having to re-configure the cabling, as was necessary in older, conventional systems.

This interface card adds two mLAN connectors to MY16-mLAN compatible devices such as the O2R96 and O1V96 digital mixing consoles, or the DM2000 and DM1000 digital production consoles.

In order to take full advantage of the MY16-mLAN's functionality, please read this manual carefully. After reading this manual, please keep it available for future reference.

## Package Contents

- MY16-mLAN unit
- Tools for MY16-mLAN (CD-ROM)
- Owner's Manual (this document)
- Tools for MY16-mLAN Installation Guide

### **If you're using the O1V**

If the MY16-mLAN is installed in the O1V, the MY16-mLAN will operate in maximum audio input/output 8-in/8-out, wordclock 44.1 kHz / 48 kHz only, and transmission speed 400 Mbps. Also, it will be shown as MY8-mLAN in the O1V's display (page 7).

### **About the included CD-ROM**

The MY16-mLAN is shipped with a CD-ROM that contains software that is useful when used in conjunction with the MY16-mLAN. This software includes drivers that are required to connect the MY16-mLAN to a computer. It also includes "mLAN Graphic Patchbay," which enables you to route audio and MIDI signals between mLAN devices. For more information, refer to the separate "Tools for MY16-mLAN Installation Guide" and the mLAN Graphic Patchbay PDF manuals.

**Yamaha is not held responsible for damage caused by improper use of or modifications to the device or for data that is lost or destroyed.**

- The illustrations and LCD screens shown in this Owner's Manual are for instructional purposes only and may appear somewhat different from those on your device.
- mLAN is a trademark of Yamaha Corporation.
- Company names and product names in this Owner's Manual are the trademarks or registered trademarks of their respective owners.

## Features

### ■ Fast data transfer via mLAN

mLAN is a digital network designed for music. It uses the IEEE1394 high performance serial bus and allows you to construct systems that are more sophisticated yet simpler than ever before. The MY16-mLAN can transmit data at a transfer rate of up to 400Mbps (S400).

### ■ Set up mLAN connections intuitively using a graphical user interface

From your computer you can specify the audio/MIDI signal flow and make synchronization settings intuitively and easily; the "mLAN Auto Connector" software makes it easy to connect mLAN devices to your computer, and "mLAN Graphic Patchbay" lets you connect multiple mLAN devices simply by making settings on your computer screen.

### ■ Up to 16 channels of audio I/O and one MIDI I/O port

When the device in which the MY16-mLAN is installed is connected to other mLAN devices, you have up to 16-in and 16-out channels of audio, plus 1-in and 1-out MIDI port.

**NOTE** If the MY16-mLAN is installed in the 01V, the maximum number of audio channels is 8-in and 8-out.

## Table of Contents

Introduction.....	3
Package Contents .....	3
Features .....	4
Fundamentals of mLAN.....	5
Operational Flow for Sound Output.....	6
Devices that are compatible with the MY16-mLAN .....	7
Installing the MY16-mLAN .....	8
Names and Functions .....	9
Connections .....	10
System Examples .....	11
Making mLAN Connections .....	14
Troubleshooting .....	15
Specifications.....	20

## Fundamentals of mLAN

mLAN is a digital network for music that was developed based on IEEE1394, an industry-standard high-performance data communications protocol.

Digital music environments that do not feature mLAN require dozens of cables for various devices and purposes, including MIDI cables and audio cables to route MIDI and audio signals. If you wish to make changes to such systems, you must physically disconnect and re-connect these cables.

For example, adding another synthesizer to a system requires two MIDI cables and two or more cables for audio (for stereo equipment). Making the appropriate connections may require special knowledge of inputs, outputs, stereo settings, and perhaps connector impedance.

The larger the system, the more complicated and expensive these connections become, increasing the likelihood of errors and difficulties. It takes time and effort to investigate such errors and their underlying causes. You may have already experienced the unpleasantness of tracking various cables through a spider's web of connections.

mLAN simplifies cable connections by using only one type of IEEE1394 cable, thus enabling you to configure extremely sophisticated systems. There is no need to re-patch cables to change routings of MIDI and audio signals between mLAN devices.

## Operational Flow for Sound Output

1. **Install the MY16-mLAN into your device.**  
.....See page 8.
2. **Install Tools for MY16-mLAN.**  
.....See "Installing the Software" in the Installation Guide.
3. **Connect the computer and mLAN devices using the IEEE1394 cables.**  
.....See page 10.
4. **Turn on mLAN Manager (Windows only).**  
.....See "Confirming the installation" in the Installation Guide.
5. **To connect a computer to a single mLAN device directly, first start mLAN Auto Connector. To connect a computer to multiple mLAN devices, start mLAN Graphic Patchbay.**  
.....See page 14.
6. **Configure connections in mLAN Auto Connector or mLAN Graphic Patchbay.**  
.....Using Auto Connector: See "Connecting a Computer to an mLAN device via mLAN" in the Installation Guide.  
.....Using Graphic Patchbay: See "mLAN Connection Settings" in the Graphic Patchbay Online Manual.
7. **Make settings for audio and MIDI input/output as described in the owner's manual for your DAW (Digital Audio Workstation) or your connected device(s).**

For subsequent steps, refer to the owner's manual for the software and connected devices.

**NOTE** In this manual, setting up audio, MIDI, and wordclock routings is referred as "mLAN connection."

# Devices that are compatible with the MY16-mLAN



**If you're using a device that has more than one mini-YGDAI slot**

If you will be handling MIDI data in your mLAN system, install the MY16-mLAN into "slot 1" of your device. If it is installed in other than "slot 1," you won't be able to transmit or receive MIDI.

## Compatible devices

The MY16-mLAN can be installed in the following devices. This table also shows the maximum number of audio input and output channels and MIDI ports that can be used with the MY16-mLAN.

Compatible device	Maximum number of audio channels		Number of MIDI ports
	Fs: 44.1kHz/48kHz	Fs: 88.2kHz/96kHz	
01V (Ver. 1.06 or later)	8In / 8Out	Not supported	1In / 1Out
01V96 (Ver. 2.01 or later)	16In / 16Out	8In / 8Out	
02R96 (Ver. 2.11 or later)			
DM1000 (Ver. 2.01 or later)			
DM2000 (Ver. 2.11 or later)			

**(NOTE) If you're using the 01V**

If the MY16-mLAN is installed in the 01V, the MY16-mLAN will operate in maximum audio input/output 8-in/8-out, wordclock 44.1 kHz / 48 kHz only, and transmission speed 400 Mbps. Also, it will be shown as MY8-mLAN in the 01V's display.

**(NOTE) If you're using a 01V96/DM1000 system version earlier than 2.01, or 02R96/DM2000 system version earlier than 2.11**

In order to allow it to operate as the MY16-mLAN, you will need to update your device. For details on updating, refer to the following URL.

Yamaha Pro Audio  
<http://www.yamahaproaudio.com/>

# Installing the MY16-mLAN

Here's how to install the MY16-mLAN in your device. You should also refer to the owner's manual of the device into which you're installing the MY16-mLAN.



Before you begin the installation, carefully read the "PRECAUTIONS" on page 2.



Don't change the setting of DIP switch SW1. The unit may no longer operate correctly if you move SW1. If you inadvertently move it, restore the factory settings as described below.

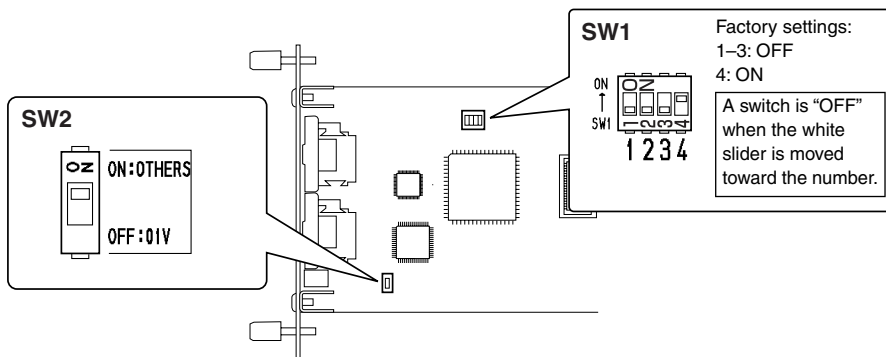

1. Set the MY16-mLAN's DIP switch SW2 as appropriate for your device. If you're installing the MY16-mLAN in a device other than the 01V, set this switch to "ON:OTHERS." If you're installing the MY16-mLAN in the 01V, set this switch to "OFF:01V."

You must set the DIP switch before installing the MY16-mLAN in your device. You won't be able to change the DIP switch setting once you've installed the MY16-mLAN. If you need to change the setting, turn off the power of your device, remove the MY16-mLAN, and then change the setting.

2. Install the MY16-mLAN in your device. For details, refer to the owner's manual of the device in which you're installing it.



Before you install the card, you must power off any peripheral equipment connected to the device in which you're installing it, and disconnect all cables.



The screws also function as an electrical ground, so be sure to tighten them securely.

The device in which you're installing the MY16-mLAN must remain power off while you install the MY16-mLAN.

3. Connect the device in which the MY16-mLAN is installed to your mLAN devices or IEEE1394-compatible computer (page 10).



# Names and Functions

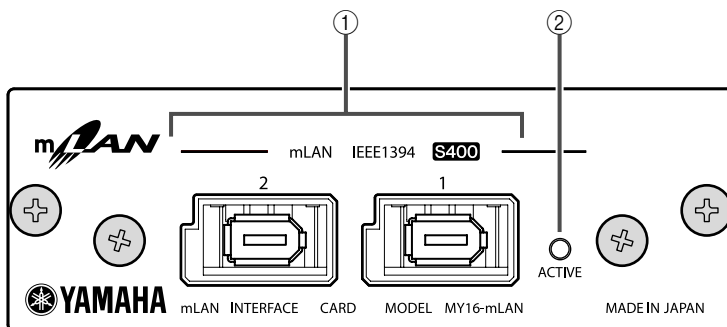

## ① mLAN (IEEE1394) jacks

These 6-pin IEEE1394 standard jacks enable you to connect mLAN devices or IEEE1394-compatible (FireWire/i.LINK) computers.

If the connecting device features a 6-pin IEEE1394 jack, use a standard 6-pin to 6-pin IEEE1394 cable. If it features a 4-pin IEEE1394 jack, use a standard 6-pin to 4-pin IEEE1394 cable. Do not connect the cables in a loop. (See page 17).

**(NOTE)** We recommend S400 compatible IEEE1394 cables (mLAN cables) that are no longer than 4.5 meters.

## ② ACTIVE indicator

This indicator lights up when the MY16-mLAN is operating.

The indicator turns off when an error occurs during an operation.

When you click the [ID (Identify)] button in mLAN Auto Connector or mLAN Graphic Patchbay (page 14) to identify the corresponding mLAN device in the network, the indicator flashes.

**(NOTE)** The indicator also lights up if an mLAN cable is not connected to the unit.

# Connections

This section explains how to connect the MY16-mLAN to other mLAN devices and to your computer.

## Connecting an mLAN (IEEE1394) device

Connect the mLAN (IEEE1394) connector on the mLAN device and IEEE1394-compatible computer to the mLAN connector on the MY16-mLAN using IEEE1394 (FireWire/i.LINK) cables. At this time, you do not have to turn off the power to the mLAN device or the MY16-mLAN-equipped device.

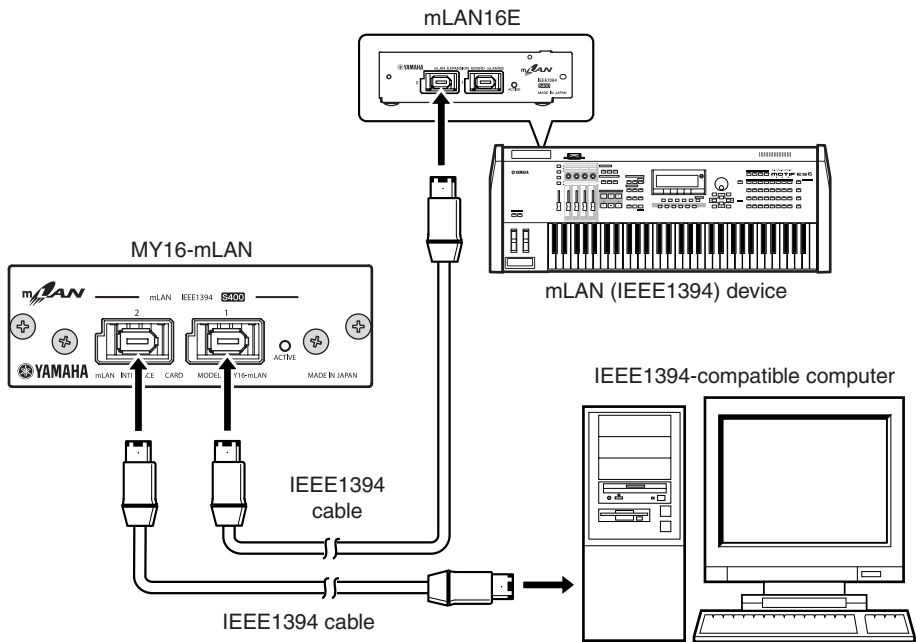

# System Examples

This section introduces typical system examples that feature the MY16-mLAN. Refer to these examples for information on connecting external devices, such as microphones, musical instruments, and computers.

## Using the MY16-mLAN connected to your computer

Use an IEEE1394 cable to connect the IEEE1394 connector on an IEEE1394-compatible computer to the mLAN connector on an MY16-mLAN-equipped device. Use the mLAN Auto Connector or mLAN Graphic Patchbay software application (See page 14) on the computer to patch the audio and MIDI signals and to set up the wordclock. By making an mLAN connection between your computer and the MY16-mLAN-equipped device, you'll be able to transfer multiple channels of audio in realtime between your computer and the device.

**NOTE** Like example below, we recommend that you use the USB cable in the operation of Studio Manager. If you use the mLAN/MIDI cable to transmit or receive MIDI, operating Studio Manager may require more time.

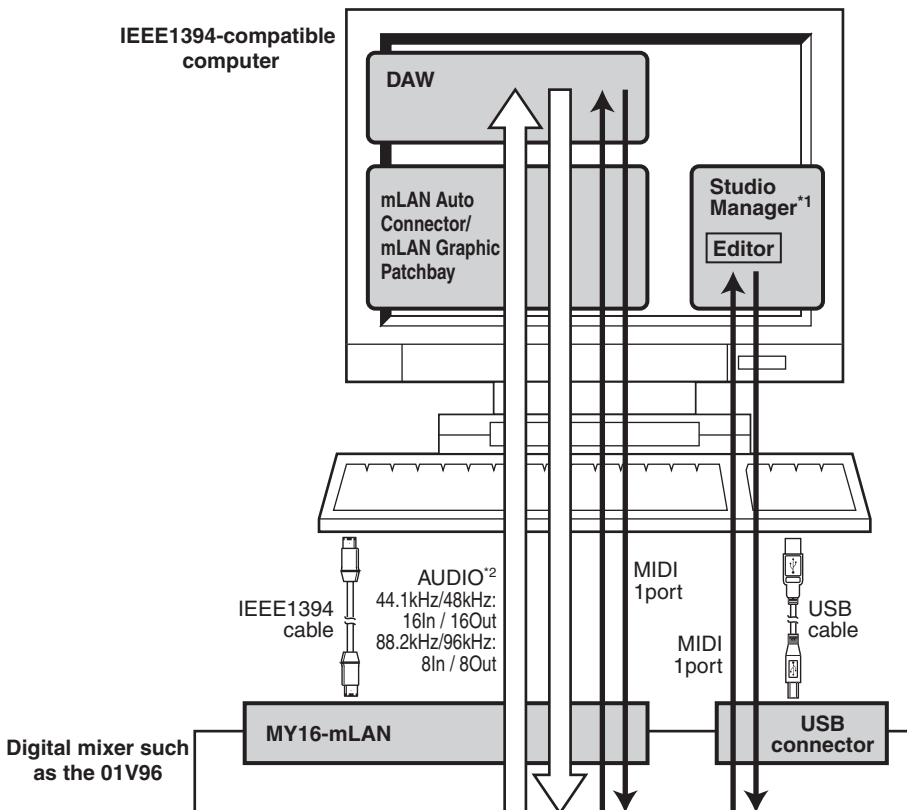

\*1: The 01V is not supplied with editor software for a computer.

\*2: The 01V is limited to 44.1 kHz / 48 kHz, and 8-in/8-out.

## System configured around Yamaha 01V96 Digital Mixing Console

Use IEEE1394 cables to connect an MY16-mLAN-equipped 01V96, an i88X audio MIDI interface, an mLAN16E-equipped MOTIF ES music production synthesizer, and an IEEE1394-compatible computer. Use mLAN Graphic Patchbay (See page 14) on the computer to patch the audio and MIDI signals and to set up the wordclock. Configuring an mLAN system around the 01V96 enables you to do the following:

- Transfer audio and MIDI data between mLAN devices simply by connecting them via IEEE1394 cables
- Set up and modify audio and MIDI signal patches between mLAN devices in various situations using mLAN Graphic Patchbay, without physically re-patching cables

**NOTE** Like example below, we recommend that you use the USB cable in the operation of Studio Manager. If you use the mLAN/MIDI cable to transmit or receive MIDI, operating Studio Manager may require more time.

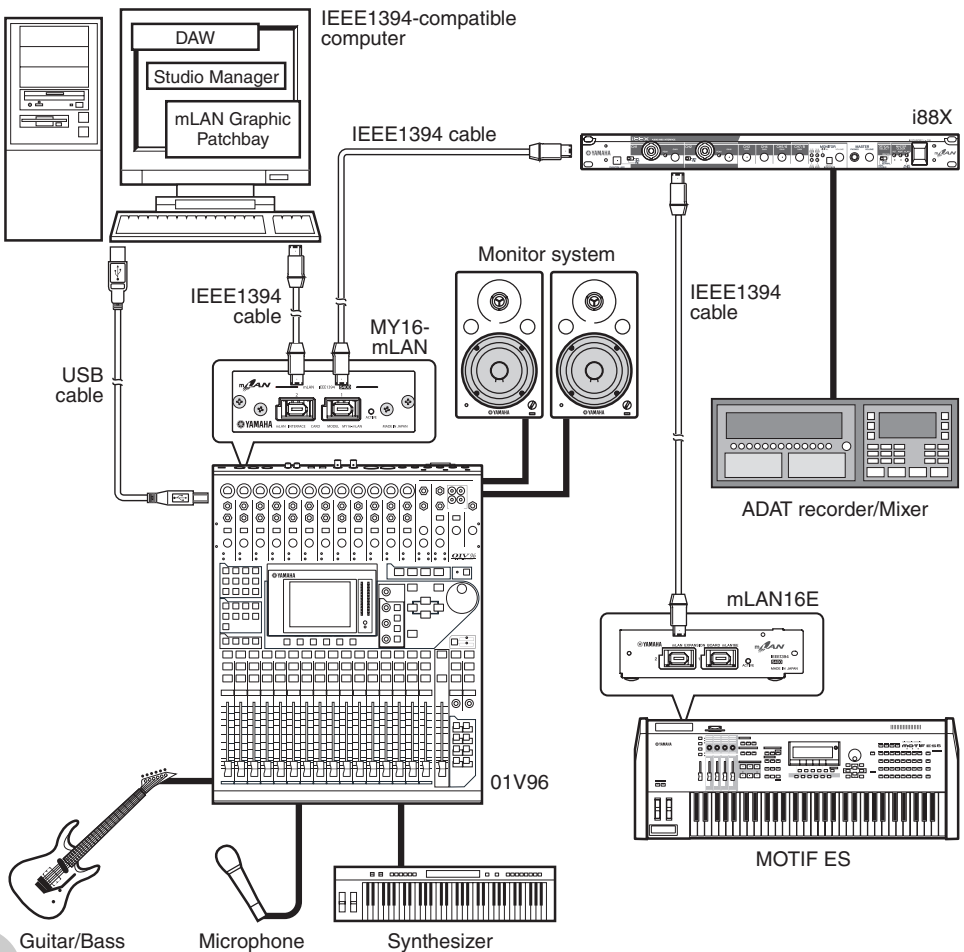

**NOTE** The number of available input and output channels may vary depending on the specific mLAN devices connected. For the best performance, it is recommended that you connect up to four mLAN devices (including a computer) in a network. If the network contains an mLAN device that is only compatible with a low transfer rate (200 Mbps (S200)), the number of devices and channels available for connection will be reduced.

### Wordclocks

In a system that features multiple digitally-connected devices, all digital devices must be synchronized when digital audio signals are transferred from one device to another.

Even if the devices use matching sampling frequencies, if their audio processing timing is not synchronized, they might not receive signals correctly, and audible noise, glitches or clicks may occur. Synchronization is achieved using a wordclock (a clock signal that synchronizes all digital audio signals in a system).

In a typical digital audio system, one device operates as the wordclock “master” and transmits a wordclock signal. The other devices operate as wordclock “slaves,” synchronizing to the wordclock master. To connect the MY16-mLAN to external devices via mLAN, you must first make clock settings for the device in which the MY16-mLAN is installed. Then in mLAN Auto Connector or mLAN Graphic Patchbay, select a device to be the master, and set the other devices as slaves. If the MY16-mLAN is used as a wordclock slave, it can operate at a sampling frequency of 44.1 kHz, 48 kHz, 88.2 kHz or 96 kHz. If the MY16-mLAN is used as the wordclock master, it will operate at the wordclock used by the MY16-mLAN-equipped device.

For information on setting the sampling frequency and wordclock, refer to the Installation Guide, or to the mLAN Graphic Patchbay Online Manual, or the owner’s manual for your device.

# Making mLAN Connections

In an mLAN system, you can easily configure and maintain the system, connect or disconnect the mLAN connectors on the computer and each mLAN device (virtual audio / MIDI input and output connectors), and make various mLAN connection settings (such as synchronization) by using the mLAN Graphic Patchbay and mLAN Auto Connector software applications. There is no need to re-patch audio and MIDI cables to accommodate various music production environments.

## mLAN Auto Connectors

This software application enables you to connect a computer to a single mLAN device.

It enables you to easily select wordclock and audio input and output channels.

For information on installing and using the software, refer to the separate Installation Guide.

**NOTE** You can also use mLAN Graphic Patchbay to connect a computer to a single mLAN device.

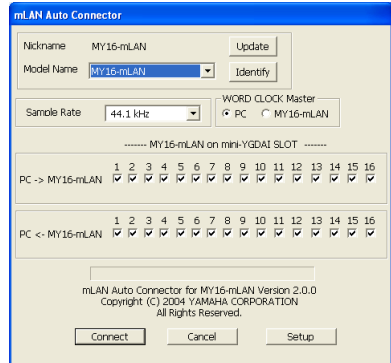

## mLAN Graphic Patchbay

This graphic software application enables you to manage mLAN connection settings for the connected computer and multiple mLAN devices. You can immediately grasp connections in their entirety by viewing displayed mLAN system configuration graphics. You can also intuitively modify wordclock settings and audio and MIDI signal routing, much as if you were connecting physical cables.

For information on installing and using the software, refer to the separate Installation Guide and the mLAN Graphic Patchbay Online Manual.

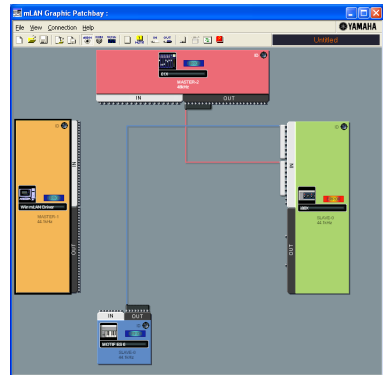

## Saving mLAN connection settings to the corresponding mLAN device

When you make mLAN connections on the computer, the connection settings will be automatically saved in the corresponding mLAN devices. Therefore, if you used mLAN Graphic Patchbay to configure a network that excludes a computer, the next time you use the network, you will be able to activate the network just by turning on the power to the network's mLAN devices (without starting the computer).

# Troubleshooting

## If you encounter a problem...

If you hear no sound or a strange sound, first check the items described below and take appropriate action. If the problem persists, consult your Yamaha dealer.

### ■ No sound or very low volume level

- Are speakers or headphones connected correctly to the MY16-mLAN-equipped device?
- Are your amp and other external devices for the MY16-mLAN-equipped device turned on?
- Are all the level settings (of any tone generators, playback devices and the application itself) appropriate?
- The connection cable from the external device to the MY16-mLAN-equipped device may be broken.
- Is the wordclock setting correct for both the MY16-mLAN and the external device(s)?  
.....Refer to "Connecting a Computer to an mLAN device via mLAN" in the Installation Guide, and "Wordclock Settings" in the mLAN Graphic Patchbay Online Manual.
- (For Windows) Is mLAN (mLAN Driver) set to "ON"? From the task bar, right click on the mLAN Manager (mLAN icon).
- Are the other settings of mLAN appropriate?  
.....Refer to "Unable to communicate via mLAN (page 17)."
- If there are more than four devices (including a computer) on the network, the limit of the IEEE1394 BUS bandwidth may be exceeded.
- The limit of the IEEE1394 BUS bandwidth may have been exceeded. Check the current bandwidth using mLAN Graphic Patchbay, and disconnect some devices if necessary.  
.....Refer to "Menu Bar" in the mLAN Graphic Patchbay Online Manual.
- If there is an mLAN device that supports only S200 on the mLAN network, the IEEE1394 BUS bandwidth may be reduced and its limit exceeded. Reduce the number of mLAN devices connected to the network, or disconnect some devices as necessary.  
.....Refer to "Menu Bar" in the mLAN Graphic Patchbay Online Manual.

### ■ Distorted sound

- The connection cable from the external device may be broken.
- Is the wordclock setting correct for both the MY16-mLAN and the external device(s)?  
.....Refer to "Connecting a Computer to an mLAN device via mLAN" in the Installation Guide and "Wordclock Settings" in the mLAN Graphic Patchbay Online Manual.
- Make sure audio data was recorded at an appropriate level.

### ■ Noise is audible

- Is the latency setting of the mLAN Driver appropriate?  
.....Refer to "mLAN Driver Setup" and "ASIO mLAN Control Panel" in the Installation Guide.
- (For Windows) Setting Hyper Threading to off in the BIOS settings may solve the problem.
- Is the wordclock setting correct for both the MY16-mLAN and the external device(s)?  
.....Refer to "Connecting a Computer to an mLAN device via mLAN" in the Installation Guide and "Wordclock Settings" in the mLAN Graphic Patchbay Online Manual.
- If the speed of your computer's hard disk is slow, problems may occur during recording and playback.

- If you connect/disconnect the LAN, USB or the cables to the mini jacks terminals on the Macintosh you are using when using mLAN, some noise may be caused and/or data may be cut off. Make sure that you do not insert or unplug any connections when using mLAN.
- Is the number of audio channels appropriate? The amount of audio channels that can be used simultaneously differs depending on the computer capacity and speed.  
.....Refer to “Connecting a Computer to an mLAN device via mLAN” in the Installation Guide and “mLAN Connection Settings” in the mLAN Graphic Patchbay Online Manual.
- Is the sampling rate (wordclock) appropriate? A high sampling rate can be the cause of the noise depending on the computer capacity and speed.  
.....Refer to “Connecting a Computer to an mLAN device via mLAN” in the Installation Guide and “mLAN Connection Settings” in the mLAN Graphic Patchbay Online Manual.
- Make sure that the appropriate number of devices is connected to the computer. Connection of too many devices may cause noise, depending on the capacity of the computer.
- Are there any noise-producing devices (such as those containing power inverters, etc.) near the cables? Move all cables away from any possible noise sources.
- Make sure the mLAN cable is not damaged. Cables that do not satisfy IEEE1394 standards may cause noise.
- (For Windows) Do not run applications, such as anti-virus software, in the background. While using the mLAN system, turn off all applications that run in background. If these applications remain on, driver operation may become unstable and cause noise. If you do not plan to use the mLAN system, you can turn these applications on. (You can turn the mLAN driver on and off using mLAN Manager.)

#### ■ Insufficient tracks for recording or playback

- Is the number of channels for mLAN audio receiving/sending (set on the mLAN Auto Connector and mLAN Graphic Patchbay) appropriate?  
.....Refer to “Connecting a Computer to an mLAN device via mLAN” in the Installation Guide and “mLAN Connection Settings” in the mLAN Graphic Patchbay Online Manual.

#### ■ Unable to transfer MIDI data or Program Changes

- Are the mLAN cables connected correctly?
- An mLAN cable may be broken.
- Is the power turned on for the transmitting and receiving devices?
- Make sure the transmission and reception channels match.

#### ■ Incorrect pitch

- Is the unit operating on the same sampling frequency as the synchronized external device?  
.....Refer to “Connecting a Computer to an mLAN device via mLAN” in the Installation Guide and “Wordclock Settings” in the mLAN Graphic Patchbay Online Manual.
- Is the master device operating in a stable way?

#### ■ Cannot change the wordclock

- While using the mLAN system, make wordclock settings using mLAN Auto Connector or mLAN Graphic Patchbay.  
.....Refer to “Connecting a Computer to an mLAN device via mLAN” in the Installation Guide and “Wordclock Settings” in the mLAN Graphic Patchbay Online Manual.



## ■ Unable to communicate via mLAN

- Has the driver been installed? ..... Refer to the Installation Guide.
- Is the mLAN cable properly connected? Check the connection; disconnect the mLAN cable once, then insert it again.
- (For Windows) Is mLAN set to "ON"? From the task bar, right click on the mLAN Manager icon. ....Refer to "Confirming the installation" in the Installation Guide.
- (For Windows) When adding a new IEEE1394 card, right click on the mLAN Manager icon in the task bar and select "ON".  
.....Refer to "Confirming the installation" in the Installation Guide.
- Is the ACTIVE lamp on the rear panel of the MY16-mLAN lit (in blue)? If it is not lit, check the followings:
  - In mLAN Driver Setup, is the Status indicator blue? If not, restart the MY16-mLAN-equipped device and re-enable connection by using mLAN Auto Connector or mLAN Graphic Patchbay. ....Refer to "Connecting a Computer to an mLAN device via mLAN" in the Installation Guide and "mLAN Connection Settings" in the mLAN Graphic Patchbay Online Manual.
- Has connection been enabled with mLAN Auto Connector and/or Graphic Patchbay? Re-enable connection if necessary.  
.....Refer to "Connecting a Computer to an mLAN device via mLAN" in the Installation Guide and "mLAN Connection Settings" in the mLAN Graphic Patchbay Online Manual.
- Have you changed the device? Even if the model is the same, if the actual device is different, it is necessary to re-enable connection by using Auto Connector and/or Graphic Patchbay.  
.....Refer to "Connecting a Computer to an mLAN device via mLAN" in the Installation Guide and "mLAN Connection Settings" in the mLAN Graphic Patchbay Online Manual.
- Is there a loop connection? Check the cabling and make sure none of the devices are connected in a loop.

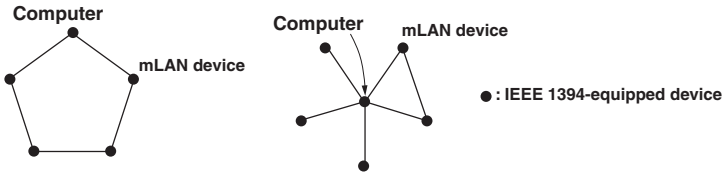

- There may be a limit on the IEEE1394 interface of your computer as to the number of ports that can be used simultaneously. Check how many ports can be used simultaneously.  
.....Refer to "Maximum Number of Connected Node" in the mLAN Graphic Patchbay Online Manual.
- Turn off all devices on the mLAN network (except the computer) and re-connect each device one-by-one until the device causing the problem is found.
- (For Windows) (When removing the mLAN bus from the [Safely Remove Hardware] setting of the task bar.) Restart the computer when using mLAN again.
- With Macintosh notebook computers such as the iBook and PowerBook, always first connect the MY16-mLAN-equipped device and mLAN cable then turn on the power of the MY16-mLAN-equipped device, before starting up the computer.
- Make sure that you set up the wordclock correctly. Also, make sure that one node is assigned as master and the other nodes are assigned as slaves.  
.....Refer to "mLAN Connection Settings" in the mLAN Graphic Patchbay Online Manual.

■ **An application, such as a DAW, fails to recognize the mLAN driver (MIDI/audio).**

- (For Windows) Make sure mLAN has not been turned off. On the task bar, right-click mLAN Manager , then select ON.  
.....Refer to “Confirming the installation” in the Installation Guide and “mLAN Connection Settings” in the mLAN Graphic Patchbay Online Manual.
- Make sure the MY16-mLAN is connected to the mLAN cable and is powered on. Start mLAN Auto Connector or mLAN Graphic Patchbay, then re-connect the device.  
.....Refer to “Confirming the installation” in the Installation Guide and “mLAN Connection Settings” in the mLAN Graphic Patchbay Online Manual.
- (For Macintosh) To use an iBook or PowerBook in the system, connect the MY16-mLAN-equipped device to the Macintosh using an mLAN cable, turn on the power to the MY16-mLAN-equipped device, then start the Macintosh.
- Make sure the mLAN settings are correct.  
.....Refer to “Unable to communicate via mLAN” on page 17.

■ **The computer processing speed is too slow.**

■ **The computer’s CPU meter indicates a heavy processing load.**

■ **Playback response is delayed.**

- Make sure your computer satisfies the system requirements.  
.....Refer to “System Requirements” in the Installation Guide.
- (For Windows) If you do not use the mLAN system, on the task bar right-click mLAN Manager , then select OFF (mLAN quits).  
.....Refer to “Confirming the installation” in the Installation Guide.
- Try reducing the number of audio channels in mLAN Auto Connector or Graphic Patchbay.  
.....Refer to “Connecting the Computer and mLAN devices via mLAN” in the Installation Guide and “mLAN Connection Settings” in the mLAN Graphic Patchbay Online Manual.
- Try increasing the latency value.  
.....Refer to “Changing the Settings after Installation” in the Installation Guide.
- (For Windows) Refer to “Hints when using audio data (Windows).”  
.....Refer to the Installation Guide.
- (For Windows) The condition may improve if you set “Hyper Threading” to “Disable.”
- Using mLAN Graphic Patchbay, try reducing the number of devices connected to the computer.  
.....Refer to “mLAN Connection Settings” in the mLAN Graphic Patchbay Online Manual.
- If multiple S200-compatible devices are connected to the network, connecting mLAN devices in mLAN Graphic Patchbay may require more time.

■ **Inconsistency in wordclock, or unable to exit from Auto Connector**

- (For Windows) Mobile computers with Intel CPU SpeedStep™ technology is applied for some CPU’s (CPU for notebook PC). Please disable the SpeedStep™ technology when mLAN is employed. SpeedStep™ technology changes CPU clock dynamically depending on the loading on the CPU to save the power consumption.
  - How to disable the SpeedStep™ technology;  
In almost all of the PC’s, BIOS has a function to select enabling or disabling the SpeedStep™ technology. Please refer to the PC’s operating manual, or make inquiry to the PC manufacturer.

■ **Unable to close the application or operating system**

■ **Unable to change the mLAN settings**

■ **Unable to uninstall mLAN Applications for Yamaha or mLAN Tools 2.0**

- (For Windows) Is the mLAN (WDM) driver selected as the default audio device for the system?
  - Select [Start | Control Panel | Sounds and Audio Devices | Voice].  
Make sure that something other than “mLAN Audio 01” is selected for the [Voice playback] and [Voice recording] settings.
  - Select [Start | Control Panel | Sounds and Audio Devices | Audio].  
Make sure that something other than “mLAN Audio 01” is selected for the [Sound playback] and [Sound recording] settings.
  - In “MIDI music playback,” select any option other than the range of options from “mLAN MIDI Out” through “mLAN MIDI Out (8).”
- (For Windows) Select [Start | Control Panel | Sounds and Audio Devices | Sounds]. And select “No sounds” in the [Sound scheme], then execute again.
- (For Windows) If you cannot quit mLAN (by selecting “OFF” after right clicking the mLAN icon in the task bar), end the processes listed below manually. ([Ctrl] + [Alt] + [Delete] → [Processes] → select process → [End process]) When finished, start mLAN Manager to change the mLAN settings again.
  - mLANVDevice.exe
  - mLANFamily.exe
  - mLANSoftPH.exe
  - mLANManager.exe

To change mLAN settings, select [Start | (All) Programs | Start Up], then start mLAN Manager.

- (When a message such as “file cannot be found” appears when uninstalling:)  
Try executing the installation once more, then uninstall again.

■ **(Windows) mLAN Manager (the mLAN icon in the Task bar) has disappeared.**

- Select [Start | (All) Programs | Start Up (or mLAN Tools)], then select mLAN Manager.

■ **Launching mLAN Graphic Patchbay or updating to the latest information takes a while.**

- When you try to update the network information after connecting or disconnecting an mLAN device that does not support S400, the system adjusts the mLAN transfer speed, and requires more time to process your request. However, this will not affect any subsequent operations.
- If five or more mLAN devices (including a computer) have been connected to a network, the total number of transmission channels of all devices will be limited. You can connect up to 86 channels in Windows and up to 98 channels in a Macintosh system.

# Specifications

<b>Supported Host products</b>	01V96, DM1000, 02R96 (up to 3 cards), DM2000 (up to 3 cards), 01V 01V96 and DM1000: Supported in V2.01 or later. 02R96 and DM2000: Supported in V2.11 or later. 01V: Supported in V1.06 or later; operates as MY8-mLAN
<b>Data Rate</b>	S400,S200
<b>Audio</b>	I/O: 16In/16Out @ 48kHz / 44.1kHz (8In/8Out @ 88.2kHz / 96kHz) Fs: 44.1kHz-10% to 48kHz+6% (88.2kHz-10% to 96kHz+6%) Resolution: 24bit
<b>MIDI</b>	1In/1Out, Baudrate: 31.25kbps Necessary for USB connections for using Multi Port MIDI (SLOT1 is available for Digital console within multi SLOTS)
<b>Wordclock Transition Speed setting</b>	Slow/Fast Specified by included mLAN Graphic Patchbay or Auto Connector.
<b>Indication LED</b>	ACTIVE (Blue)
<b>Host device detection switch</b>	01V/Others
<b>Others</b>	number of node: Up to 5 nodes
<b>Connectors</b>	To IEEE1394: 6 Pin x 2
<b>Power Requirement</b>	740mA (Max.) / +5V
<b>Dimension (WxDxH)</b>	120 mm x 176.1 mm x 40 mm (4-3/4" x 6-15/16" x 1-9/16")

Specifications and appearance subject to change without notice.

# MEMO

# FCC INFORMATION (U.S.A.)

## 1. IMPORTANT NOTICE: DO NOT MODIFY THIS UNIT!

This product, when installed as indicated in the instructions contained in this manual, meets FCC requirements. Modifications not expressly approved by Yamaha may void your authority, granted by the FCC, to use the product.

## 2. IMPORTANT:

When connecting this product to accessories and/or another product use only high quality shielded cables. Cable/s supplied with this product MUST be used. Follow all installation instructions. Failure to follow instructions could void your FCC authorization to use this product in the USA.

## 3. NOTE:

This product has been tested and found to comply with the requirements listed in FCC Regulations, Part 15 for Class "B" digital devices. Compliance with these requirements provides a reasonable level of assurance that your use of this product in a residential environment will not result in harmful interference with other electronic devices. This equipment generates/uses radio frequencies and, if not installed and used according to the instructions found in the users manual, may cause interference harmful to the operation of other electronic

devices. Compliance with FCC regulations does not guarantee that interference will not occur in all installations. If this product is found to be the source of interference, which can be determined by turning the unit "OFF" and "ON", please try to eliminate the problem by using one of the following measures:

Relocate either this product or the device that is being affected by the interference.

Utilize power outlets that are on different branch (circuit breaker or fuse) circuits or install AC line filter/s.

In the case of radio or TV interference, relocate/reorient the antenna. If the antenna lead-in is 300 ohm ribbon lead, change the lead-in to co-axial type cable.

If these corrective measures do not produce satisfactory results, please contact the local retailer authorized to distribute this type of product. If you can not locate the appropriate retailer, please contact Yamaha Corporation of America, Electronic Service Division, 6600 Orangethorpe Ave, Buena Park, CA90620

The above statements apply ONLY to those products distributed by Yamaha Corporation of America or its subsidiaries.

\* This applies only to products distributed by YAMAHA CORPORATION OF AMERICA.

(class B)

## CANADA

This Class B digital apparatus complies with Canadian ICES-003.

Cet appareil numérique de la classe B est conforme à la norme NMB-003 du Canada.

• This applies only to products distributed by Yamaha Canada Music Ltd.

(class B)

• Ceci ne s'applique qu'aux produits distribués par Yamaha Canada Musique Ltée.

For details of products, please contact your nearest Yamaha representative or the authorized distributor listed below.

Pour plus de détails sur les produits, veuillez-vous adresser à Yamaha ou au distributeur le plus proche de vous figurant dans la liste suivante.

Die Einzelheiten zu Produkten sind bei Ihrer unten aufgeführten Niederlassung und bei Yamaha Vertragshändlern in den jeweiligen Bestimmungsländern erhältlich.

Para detalles sobre productos, contacte su tienda Yamaha más cercana o el distribuidor autorizado que se lista debajo.

## NORTH AMERICA

### CANADA

**Yamaha Canada Music Ltd.**  
135 Milner Avenue, Scarborough, Ontario,  
M1S 3R1, Canada  
Tel: 416-298-1311

### U.S.A.

**Yamaha Corporation of America**  
6600 Orangethorpe Ave., Buena Park, Calif. 90620,  
U.S.A.  
Tel: 714-522-9011

## CENTRAL & SOUTH AMERICA

### MEXICO

**Yamaha de México S.A. de C.V.**  
Calz. Javier Rojo Gómez #1149,  
Col. Guadalupe del Moral  
C.P. 09300, México, D.F., México  
Tel: 55-5804-0600

### BRAZIL

**Yamaha Musical do Brasil Ltda.**  
Av. Reboucas 2636-Pinheiros CEP: 05402-400  
Sao Paulo-SP, Brasil  
Tel: 011-3085-1377

### ARGENTINA

**Yamaha Music Latin America, S.A.**  
Sucursal de Argentina  
Viamonte 1145 Piso2-B 1053,  
Buenos Aires, Argentina  
Tel: 1-4371-7021

### PANAMA AND OTHER LATIN AMERICAN COUNTRIES/ CARIBBEAN COUNTRIES

**Yamaha Music Latin America, S.A.**  
Torre Banco General, Piso 7, Urbanización Marbella,  
Calle 47 y Aquilino de la Guardia,  
Ciudad de Panamá, Panamá  
Tel: +507-269-5311

## EUROPE

### THE UNITED KINGDOM

**Yamaha-Kemble Music (U.K.) Ltd.**  
Sherbourne Drive, Tilbrook, Milton Keynes,  
MK7 8BL, England  
Tel: 01908-366700

### GERMANY

**Yamaha Music Central Europe GmbH**  
Siemensstraße 22-34, 25462 Rellingen, Germany  
Tel: 04101-3030

### SWITZERLAND/LIECHTENSTEIN

**Yamaha Music Central Europe GmbH, Branch Switzerland**  
Seefeldstrasse 94, 8008 Zürich, Switzerland  
Tel: 01-383 3990

### AUSTRIA

**Yamaha Music Central Europe GmbH, Branch Austria**  
Schleichergasse 20, A-1100 Wien, Austria  
Tel: 01-60203900

### THE NETHERLANDS

**Yamaha Music Central Europe, Branch Nederland**  
Clarissenhof 5-b, 4133 AB Vianen, The Netherlands  
Tel: 0347-358 040

### BELGIUM/LUXEMBOURG

**Yamaha Music Central Europe GmbH, Branch Belgium**  
Rue de Geneve (Genevestraat) 10, 1140 - Brussels,  
Belgium  
Tel: 02-726 6032

### FRANCE

**Yamaha Musique France**  
BP 70-77312 Marne-la-Vallée Cedex 2, France  
Tel: 01-64-61-4000

### ITALY

**Yamaha Musica Italia S.P.A. Combo Division**  
Viale Italia 88, 20020 Lainate (Milano), Italy  
Tel: 02-935-771

### SPAIN/PORTUGAL

**Yamaha-Hazen Música, S.A.**  
Ctra. de la Coruna km. 17, 200, 28230  
Las Rozas (Madrid), Spain  
Tel: 91-639-8888

### SWEDEN

**Yamaha Scandinavia AB**  
J. A. Wettergrens Gata 1  
Box 30053  
S-400 43 Göteborg, Sweden  
Tel: 031 89 34 00

### DENMARK

**YS Copenhagen Liaison Office**  
Generatorvej 6A  
DK-2730 Herlev, Denmark  
Tel: 44 92 49 00

### NORWAY

**Norsk filial av Yamaha Scandinavia AB**  
Grini Næringspark 1  
N-1345 Osterås, Norway  
Tel: 67 16 77 70

### OTHER EUROPEAN COUNTRIES

**Yamaha Music Central Europe GmbH**  
Siemensstraße 22-34, 25462 Rellingen, Germany  
Tel: +49-4101-3030

## AFRICA

**Yamaha Corporation, Asia-Pacific Music Marketing Group**  
Nakazawa-cho 10-1, Hamamatsu, Japan 430-8650  
Tel: +81-53-460-2313

## MIDDLE EAST

### TURKEY/CYPRUS

**Yamaha Music Central Europe GmbH**  
Siemensstraße 22-34, 25462 Rellingen, Germany  
Tel: 04101-3030

### OTHER COUNTRIES

**Yamaha Music Gulf FZE**  
L.B.21-128 Jebel Ali Freezone  
P.O.Box 17328, Dubai, U.A.E.  
Tel: +971-4-881-5868

## ASIA

### THE PEOPLE'S REPUBLIC OF CHINA

**Yamaha Music & Electronics (China) Co.,Ltd.**  
25/F., United Plaza, 1468 Nanjing Road (West),  
Jingan, Shanghai, China  
Tel: 021-6247-2211

### INDONESIA

**PT. Yamaha Music Indonesia (Distributor) PT. Nusantara**  
Gedung Yamaha Music Center, Jalan Jend. Gatot  
Subroto Kav. 4, Jakarta 12930, Indonesia  
Tel: 21-520-2577

### KOREA

**Yamaha Music Korea Ltd.**  
Tong-Yang Securities Bldg. 16F 23-8 Yoido-dong,  
Youngdungpo-ku, Seoul, Korea  
Tel: 02-3770-0660

### MALAYSIA

**Yamaha Music Malaysia, Sdn., Bhd.**  
Lot 8, Jalan Perbandaran, 47301 Kelana Jaya,  
Petaling Jaya, Selangor, Malaysia  
Tel: 3-7803900

### SINGAPORE

**Yamaha Music Asia Pte., Ltd.**  
#03-11 A-Z Building  
140 Paya Lebar Road, Singapore 409015  
Tel: 747-4374

### TAIWAN

**Yamaha KHS Music Co., Ltd.**  
3F, #6, Sec. 2, Nan Jing E. Rd. Taipei,  
Taiwan 104, R.O.C.  
Tel: 02-2511-8688

### THAILAND

**Siam Music Yamaha Co., Ltd.**  
891/1 Siam Motors Building, 15-16 floor  
Rama 1 road, Wangmai, Pathumwan  
Bangkok 10330, Thailand  
Tel: 02-215-2626

### OTHER ASIAN COUNTRIES

**Yamaha Corporation, Asia-Pacific Music Marketing Group**  
Nakazawa-cho 10-1, Hamamatsu, Japan 430-8650  
Tel: +81-53-460-2317

## OCEANIA

### AUSTRALIA

**Yamaha Music Australia Pty. Ltd.**  
Level 1, 99 Queensbridge Street, Southbank,  
Victoria 3006, Australia  
Tel: 3-9693-5111

### COUNTRIES AND TRUST TERRITORIES IN PACIFIC OCEAN

**Yamaha Corporation, Asia-Pacific Music Marketing Group**  
Nakazawa-cho 10-1, Hamamatsu, Japan 430-8650  
Tel: +81-53-460-2313

**HEAD OFFICE** Yamaha Corporation, Pro Audio & Digital Musical Instrument Division  
Nakazawa-cho 10-1, Hamamatsu, Japan 430-8650  
Tel: +81-53-460-2441



This document is printed on recycled chlorine free (ECF) paper with soy ink.

Auf Recycling-Umweltpapier gedruckt.

Ce document a été imprimé sur du papier recyclé non blanchi au chlore.

Yamaha Manual Library  
<http://www2.yamaha.co.jp/manual/english/>