



Clavinova®

CVP-909

CVP-905

Owner's Manual
Mode d'emploi
Manual de instrucciones

Thank you for purchasing this Yamaha Digital Piano!

This instrument provides a comprehensive array of authentic voices and a superb grand piano touch with versatile functions. We recommend that you read this manual carefully so that you can fully take advantage of the advanced and convenient functions of the instrument. We also recommend that you keep this manual in a safe and handy place for future reference.

Before using the instrument, be sure to read "PRECAUTIONS" on pages 5-6.

For information on assembling the instrument, refer to the instructions on page 116, 120 or 124.

Nous vous remercions d'avoir choisi ce piano numérique de Yamaha !

Cet instrument dispose d'un ensemble complet de sonorités authentiques, d'un remarquable toucher de piano à queue et de nombreuses fonctions polyvalentes.

Nous vous conseillons de lire attentivement ce mode d'emploi afin de tirer pleinement profit des fonctions avancées et pratiques de votre instrument. Nous vous recommandons également de garder ce manuel à portée de main pour toute référence ultérieure.

Avant d'utiliser l'instrument, lisez attentivement la section « PRÉCAUTIONS D'USAGE » aux pages 5 et 6.

Pour plus d'informations sur le montage de l'instrument, reportez-vous aux instructions figurant aux pages 116, 120 ou 124.

Gracias por adquirir este piano digital Yamaha

Este instrumento ofrece una completa gama de voces auténticas y un excelente tacto de piano de cola con funciones versátiles.

Le aconsejamos que lea detenidamente este manual para poder disfrutar de las útiles y avanzadas funciones del instrumento. Recomendamos guardar el manual en un lugar seguro y accesible, para futuras consultas.

Antes de utilizar el instrumento, lea las "PRECAUCIONES", en las páginas 5-6.

Para obtener más información sobre el montaje del instrumento, consulte las instrucciones de la página 116, 120 o 124.

English 
Français 
Español 



EN FR ES

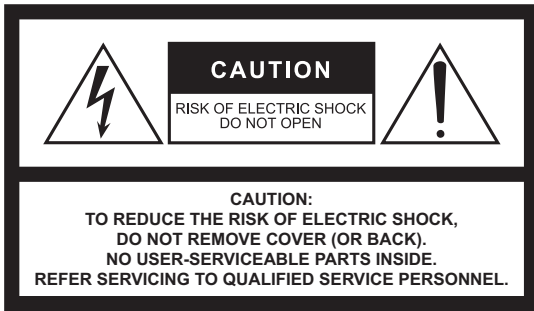

The above warning is located on the bottom of the unit.



L'avertissement ci-dessus est situé sur le dessous de l'unité.

Explanation of Graphical Symbols Explication des symboles



The lightning flash with arrowhead symbol within an equilateral triangle is intended to alert the user to the presence of uninsulated "dangerous voltage" within the product's enclosure that may be of sufficient magnitude to constitute a risk of electric shock to persons.

L'éclair avec une flèche à l'intérieur d'un triangle équilatéral est destiné à attirer l'attention de l'utilisateur sur la présence d'une « tension dangereuse » non isolée à l'intérieur de l'appareil, pouvant être suffisamment élevée pour constituer un risque d'électrocution.



The exclamation point within an equilateral triangle is intended to alert the user to the presence of important operating and maintenance (servicing) instructions in the literature accompanying the product.

Le point d'exclamation à l'intérieur d'un triangle équilatéral est destiné à attirer l'attention de l'utilisateur sur la présence d'instructions importantes sur l'emploi ou la maintenance (réparation) de l'appareil dans la documentation fournie.

IMPORTANT SAFETY INSTRUCTIONS

- 1 Read these instructions.
- 2 Keep these instructions.
- 3 Heed all warnings.
- 4 Follow all instructions.
- 5 Do not use this apparatus near water.
- 6 Clean only with dry cloth.
- 7 Do not block any ventilation openings. Install in accordance with the manufacturer's instructions.
- 8 Do not install near any heat sources such as radiators, heat registers, stoves, or other apparatus (including amplifiers) that produce heat.
- 9 Do not defeat the safety purpose of the polarized or grounding-type plug. A polarized plug has two blades with one wider than the other. A grounding type plug has two blades and a third grounding prong. The wide blade or the third prong are provided for your safety. If the provided plug does not fit into your outlet, consult an electrician for replacement of the obsolete outlet.
- 10 Protect the power cord from being walked on or pinched particularly at plugs, convenience receptacles, and the point where they exit from the apparatus.
- 11 Only use attachments/accessories specified by the manufacturer.
- 12 Use only with the cart, stand, tripod, bracket, or table specified by the manufacturer, or sold with the apparatus. When a cart is used, use caution when moving the cart/apparatus combination to avoid injury from tip-over.
- 13 Unplug this apparatus during lightning storms or when unused for long periods of time.
- 14 Refer all servicing to qualified service personnel. Servicing is required when the apparatus has been damaged in any way, such as power-supply cord or plug is damaged, liquid has been spilled or objects have fallen into the apparatus, the apparatus has been exposed to rain or moisture, does not operate normally, or has been dropped.



WARNING
TO REDUCE THE RISK OF FIRE OR ELECTRIC SHOCK, DO NOT EXPOSE THIS APPARATUS TO RAIN OR MOISTURE.

PRÉCAUTIONS CONCERNANT LA SÉCURITÉ

- 1 Lire ces instructions.
- 2 Conserver ces instructions.
- 3 Tenir compte de tous les avertissements.
- 4 Suivre toutes les instructions.
- 5 Ne pas utiliser ce produit à proximité d'eau.
- 6 Nettoyer uniquement avec un chiffon propre et sec.
- 7 Ne pas bloquer les orifices de ventilation. Installer l'appareil conformément aux instructions du fabricant.
- 8 Ne pas installer l'appareil à proximité d'une source de chaleur comme un radiateur, une bouche de chaleur, un poêle ou tout autre appareil (y compris un amplificateur) produisant de la chaleur.
- 9 Ne pas modifier le système de sécurité de la fiche polarisée ou de la fiche de terre. Une fiche polarisée dispose de deux broches dont une est plus large que l'autre. Une fiche de terre dispose de deux broches et d'une troisième pour le raccordement à la terre. Cette broche plus large ou cette troisième broche est destinée à assurer la sécurité de l'utilisateur. Si la fiche équipant l'appareil n'est pas compatible avec les prises de courant disponibles, faire remplacer les prises par un électricien.
- 10 Acheminer les cordons d'alimentation de sorte qu'ils ne soient pas piétinés ni coincés, en faisant tout spécialement attention aux fiches, prises de courant et au point de sortie de l'appareil.
- 11 Utiliser exclusivement les fixations et accessoires spécifiés par le fabricant.
- 12 Utiliser exclusivement le chariot, le stand, le trépied, le support ou la table recommandés par le fabricant ou vendus avec cet appareil. Si l'appareil est posé sur un chariot, déplacer le chariot avec précaution pour éviter tout risque de chute et de blessure.
- 13 Débrancher l'appareil en cas d'orage ou lorsqu'il doit rester hors service pendant une période prolongée.
- 14 Confier toute réparation à un personnel qualifié. Faire réparer l'appareil s'il a subi tout dommage, par exemple si la fiche ou le cordon d'alimentation est endommagé, si du liquide a coulé ou des objets sont tombés à l'intérieur de l'appareil, si l'appareil a été exposé à la pluie ou à de l'humidité, si l'appareil ne fonctionne pas normalement ou est tombé.

AVERTISSEMENT
POUR RÉDUIRE LES RISQUES D'INCENDIE OU DE DÉCHARGE ÉLECTRIQUE, N'EXPOSEZ PAS CET APPAREIL À LA PLUIE OU À L'HUMIDITÉ.

(502-M01 UL 60065-1 01)

FCC INFORMATION (U.S.A.)

1. IMPORTANT NOTICE: DO NOT MODIFY THIS UNIT!

This product, when installed as indicated in the instructions contained in this manual, meets FCC requirements. Modifications not expressly approved by Yamaha may void your authority, granted by the FCC, to use the product.

2. IMPORTANT: When connecting this product to accessories and/or another product use only high quality shielded cables. Cable/s supplied with this product MUST be used. Follow all installation instructions. Failure to follow instructions could void your FCC authorization to use this product in the USA.

3. NOTE: This product has been tested and found to comply with the requirements listed in FCC Regulations, Part 15 for Class "B" digital devices. Compliance with these requirements provides a reasonable level of assurance that your use of this product in a residential environment will not result in harmful interference with other electronic devices. This equipment generates/uses radio frequencies and, if not installed and used according to the instructions found in the users manual, may cause interference harmful to the operation of other electronic devices. Compliance with FCC regula-

tions does not guarantee that interference will not occur in all installations. If this product is found to be the source of interference, which can be determined by turning the unit "OFF" and "ON", please try to eliminate the problem by using one of the following measures:

- Relocate either this product or the device that is being affected by the interference.
- Utilize power outlets that are on different branch (circuit breaker or fuse) circuits or install AC line filter/s.
- In the case of radio or TV interference, relocate/reorient the antenna. If the antenna lead-in is 300 ohm ribbon lead, change the lead-in to co-axial type cable.

If these corrective measures do not produce satisfactory results, please contact the local retailer authorized to distribute this type of product. If you can not locate the appropriate retailer, please contact Yamaha Corporation of America, 6600 Orangethorpe Avenue, Buena Park, CA 90620, U.S.A.

The above statements apply ONLY to those products distributed by Yamaha Corporation of America or its subsidiaries.

(529-M04 FCC class B YCA 02)

COMPLIANCE INFORMATION STATEMENT (Supplier's declaration of conformity procedure)

Responsible Party : Yamaha Corporation of America

Address : 6600 Orangethorpe Ave., Buena Park, CA 90620, U.S.A.

Telephone : 714-522-9011

Type of Equipment : Digital Piano

Model Name : CVP-909GP/CVP-909/CVP-905

This device complies with Part 15 of the FCC Rules.

Operation is subject to the following two conditions:

- 1) this device may not cause harmful interference, and
- 2) this device must accept any interference received including interference that may cause undesired operation.

(529-M02 FCC sdoc YCA 02)

The model number, serial number, power requirements, etc., may be found on or near the name plate, which is at the bottom of the unit. You should note this serial number in the space provided below and retain this manual as a permanent record of your purchase to aid identification in the event of theft.

Model No.

Serial No.

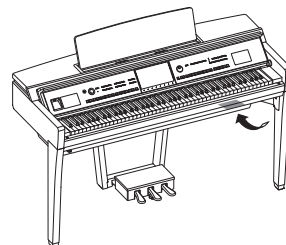

The name plate is located on the bottom of the unit.

(1003-M06 plate bottom en 01)



Information for users on collection and disposal of old equipment:

This symbol on the products, packaging, and/or accompanying documents means that used electrical and electronic products should not be mixed with general household waste. For proper treatment, recovery and recycling of old products, please take them to applicable collection points, in accordance with your national legislation.

By disposing of these products correctly, you will help to save valuable resources and prevent any potential negative effects on human health and the environment which could otherwise arise from inappropriate waste handling.

For more information about collection and recycling of old products, please contact your local municipality, your waste disposal service or the point of sale where you purchased the items.

For business users in the European Union:

If you wish to discard electrical and electronic equipment, please contact your dealer or supplier for further information.

Information on Disposal in other Countries outside the European Union:

This symbol is only valid in the European Union. If you wish to discard these items, please contact your local authorities or dealer and ask for the correct method of disposal.

(58-M02 WEEE en 01)

PRECAUTIONS

PLEASE READ CAREFULLY BEFORE PROCEEDING

Especially in the case of children, a guardian should provide guidance on how to properly use and handle the product before actual use. Please keep this manual in a safe and handy place for future reference.



WARNING

Always follow the basic precautions listed below to avoid the possibility of serious injury or even death from electrical shock, short-circuiting, damages, fire or other hazards. These precautions include, but are not limited to, the following:

Power supply

- Do not place the power cord near heat sources such as heaters or radiators. Also, do not excessively bend or otherwise damage the cord, or place heavy objects on it.
- Do not touch the product or the power plug during an electrical storm.
- Use only the correct voltage specified for the product. The required voltage is printed on the name plate of the product.
- Use only the supplied power cord/plug. Do not use the power cord/plug for other devices.
- Check the power plug periodically and remove any dirt or dust which may have accumulated on it.
- Insert the power plug firmly all the way into the AC outlet. Using the product when it is not plugged in sufficiently can cause dust to accumulate on the plug, possibly resulting in fire or skin burns.
- When setting up the product, make sure that the AC outlet you are using is easily accessible. If some trouble or malfunction occurs, immediately turn off the power switch and disconnect the plug from the outlet. Even when the power switch is turned off, as long as the power cord is not unplugged from the wall AC outlet, the product will not be disconnected from the power source.
- Do not connect the product to an electrical outlet using a multi-plug outlet extender. Doing so can result in lower sound quality, or possibly cause overheating in the outlet.
- When disconnecting the power plug, always hold the plug itself and not the cord. Pulling by the cord can damage it and cause electric shocks or a fire.
- If not using the product for long periods of time, be sure to pull the power plug from the AC outlet.

Do not disassemble

- This product contains no user-serviceable parts. Do not attempt to disassemble the internal parts or modify them in any way.

Water warning

- Do not expose the product to rain, use it near water or in damp or wet conditions, or place on it any containers (such as vases, bottles or glasses) containing liquids which might spill into any openings or places where water may drop. A liquid such as water getting into the product may cause a fire, electric shocks, or malfunctions.
- Never insert or remove a power plug with wet hands.

Fire warning

- Do not place any burning items or open flames near the product, since they may cause a fire.

Wireless unit

- Radio waves from this product may affect electro-medical devices, such as a heart pacemaker implant or defibrillator implant.
 - Do not use the product near medical devices or inside medical facilities. Radio waves from this product may affect electro-medical devices.
 - Do not use the product within 15 cm (6 in.) of persons with a heart pacemaker implant or a defibrillator implant.

Connections

- Be sure to read the manual of the device to be connected, and follow the instructions. Failure to observe this may cause a fire, overheating, explosion, or malfunction.

Using the bench (if included)

- Do not place the bench in an unstable position where it might accidentally fall over.
- Do not play carelessly with or stand on the bench. Using it as a tool or stepladder or for any other purpose might result in accident or injury.
- Only one person should sit on the bench at a time, in order to prevent the possibility of accident or injury.
- If the bench screws become loose due to extensive long-term use, tighten them periodically using the specified tool in order to prevent the possibility of accident or injury.
- Keep special watch over any small children so that they don't fall off the rear of the bench. Since the bench does not have a backrest, unsupervised use may result in accident or injury.

If you notice any abnormality

- If any of the following problems occur, immediately turn off the power switch and disconnect the power plug from the outlet.
Finally have the device inspected by Yamaha service personnel.
 - The power cord or plug becomes frayed or damaged.
 - Unusual smells or smoke are emitted.
 - Some object, or water has been dropped into the product.
 - There is a sudden loss of sound during use of the product.
 - Cracks or other visible damage appear on the product.



CAUTION

Always follow the basic precautions listed below to avoid the possibility of physical injury to you or others, or damage to the instrument or other property. These precautions include, but are not limited to, the following:

Assembly

- Assemble the product in the proper sequence by following the assembly instructions in this manual. Also, make sure to tighten the screws regularly. Failure to do so might result in damage to the product or even injury.

Location

- Do not place the product in an unstable position or a location with excessive vibration, where it might accidentally fall over and cause injury.
- Do not go near the product during an earthquake. Strong shaking during an earthquake could cause the product to move or tip over, resulting in damage to the product or its parts, and possibly causing injury.
- (CVP-909 grand piano type) Since this product is very heavy, make sure that a sufficient number of people are on hand to help, so you can lift and move it safely and easily. Attempting to lift or move the instrument by force may damage your back, result in other injury, or cause damage to the product itself.
- (CVP-909, CVP-905) When transporting or moving the product, always use two or more people. Attempting to lift the product by yourself may result in injuries, such as back injuries, or cause the product to be dropped and broken, which could lead to other injuries.
- Before moving the product, remove all connected cables, to prevent damage to the cables or injury to anyone who might trip over them.

Connections

- Before connecting the product to other devices, turn off the power for all devices. Before turning the power on or off for all devices, set all volume levels to minimum.
- Be sure to set the volumes of all devices at their minimum levels and gradually raise the volume controls while playing the product to set the desired listening level.

Handling

- Do not insert your finger or hand in any gaps on the key cover or product. Also take care that the key cover does not pinch your finger.
- Do not insert foreign materials such as metal or paper into any openings or gaps of the product. Failure to observe this may cause a fire, electric shocks, or malfunctions.
- Do not rest your weight on, or place heavy objects on the product, and do not use excessive force on the buttons, switches or connectors.
- Keep small parts out of the reach of infants. Your children may accidentally swallow them.
- Do not use the product or headphones for a long period of time at a high or uncomfortable volume level, since this can cause permanent hearing loss. If you experience any hearing loss or ringing in the ears, consult a physician.
- Remove the power plug from the AC outlet before cleaning the unit. Failure to observe this may cause electric shocks.

Using the bench (if included)

- For benches that can be adjusted, do not adjust the bench height while sitting on the bench, since this can cause excessive force applied to the adjustment mechanism, possibly resulting in damage to the mechanism or even injury.
- Do not place your hand between moving parts. Otherwise, your hand could be pinched between the parts, possibly resulting in injury.

Yamaha cannot be held responsible for damage caused by improper use or modifications to the instrument, or data that is lost or destroyed.

Always turn the power off when the instrument is not in use.

Even when the [⏻] (Standby/On) switch is in standby status (display is off), electricity is still flowing to the instrument at the minimum level.

When you are not using the instrument for a long time, make sure you unplug the power cord from the wall AC outlet.

(DMI-11)

NOTICE

To avoid the possibility of malfunction/damage to the product, damage to data, or damage to other property, follow the notices below.

■ Handling

- Do not connect this product to a public Wi-Fi and/or Internet service directly. Only connect this product to the Internet through a router with strong password protections. Consult your router manufacturer for information on optimum security practices.
- Do not use this product in the vicinity of a TV, radio, stereo equipment, mobile phone, or other electric devices. Otherwise, this product or the other device may generate noise.
- When you use the product along with an app on your smart device such as a smartphone or tablet, we recommend that you enable "Airplane Mode" on the device to avoid noise caused by communication. When wirelessly connecting a smart device with this product, make sure that the Wi-Fi or *Bluetooth*[®] setting on the device is turned on.
- Do not expose the product to excessive dust or vibrations, or extreme cold or heat (such as in direct sunlight, near a heater, or in a car during the day) to prevent the possibility of disfiguration, damage to the internal components or unstable operation. (Verified operating temperature range: 5° – 40°C, or 41° – 104°F.)
- Do not place vinyl, plastic or rubber objects on the product, since this might discolor the product.
- In the case of a model with a polished finish, bumping the surface of the product with metal, porcelain, or other hard objects can cause the finish to crack or peel. Use caution.

■ Maintenance

- When cleaning the product, use a soft and dry (or slightly damp) cloth. Do not use paint thinners, solvents, alcohol, cleaning fluids, or chemical-impregnated wiping cloths.
- In the case of a model with a polished finish, gently remove dust and dirt with a soft cloth. Do not wipe too hard since small particles of dirt can scratch the instrument's finish.
- During extreme changes in temperature or humidity, condensation may occur and water may collect on the surface of the product. If water is left, the wooden parts may absorb the water and be damaged. Make sure to wipe any water off immediately with a soft cloth.

■ Saving data

- Recorded Song and edited Song/Style/Voice/MIDI setup data, etc. are lost when you turn off the power to the product. This also occurs when the power is turned off by the Auto Power Off function (page 19). Save the data to the product, or to a USB flash drive (page 32).

- You can back up the data and settings of this product to the USB flash drive as a backup file (page 43), as well as restore a backup file to the product. To protect against data loss due to some failure, an operation mistake, etc., save your important data to a USB flash drive.
- To protect against data loss through USB flash drive damage, we recommend that you save your important data onto spare USB flash drive or an external device such as a computer as backup data.

Information

■ About copyrights

- The copyright of the "content"^{*1} installed in this product belongs to Yamaha Corporation or its copyright holder. Except as permitted by copyright laws and other relevant laws, such as copying for personal use, it is prohibited to "reproduce or divert"^{*2} without the permission of the copyright holder. When using the content, consult with a copyright expert. If you create music or perform with the contents through the original use of the product, and then record and distribute them, the permission of Yamaha Corporation is not required regardless of whether the distribution method is paid or free of charge.

*1: The word "content" includes a computer program, audio data, Accompaniment Style data, MIDI data, waveform data, voice recording data, music score, and score data, etc.

*2: The phrase "reproduce or divert" includes taking out the content itself in this product, or recording and distributing it without changes in a similar manner.

■ About functions/data bundled with the product

- Some of the preset songs have been edited for length or arrangement, and may not be exactly the same as the original.
- This device is capable of using various types/formats of music data by optimizing them to the proper format music data for use with the device in advance. As a result, this device may not play them back precisely as their producers or composers originally intended.

■ About this manual

- Unless indicated otherwise, the illustrations and displays as shown in this manual are based on the CVP-909 (in English). These are for instructional purposes only.
- The letters at the end of the model name (such as "B," "PE," "GP") indicate the color, finish or shape of the instrument. Since they simply indicate the appearance, these letters are omitted in this manual.
- Windows is a registered trademark of Microsoft[®] Corporation in the United States and other countries.
- Wi-Fi is a registered trademark of Wi-Fi Alliance[®].

- The *Bluetooth*® word mark and logos are registered trademarks owned by Bluetooth SIG, Inc. and any use of such marks by Yamaha Corporation is under license.



- The company names and product names in this manual are the trademarks or registered trademarks of their respective companies.

■ Tuning

- Unlike an acoustic piano, this instrument does not need to be tuned by an expert (although the pitch can be user-adjusted to match other instruments). This is because the pitch of digital instruments is always maintained perfectly.

■ About disposal

- When disposing of this product, please contact the appropriate local authorities.

Compatible formats for this instrument

■ GM2

“GM (General MIDI)” is one of the most common Voice allocation formats. “GM System Level 2” is a standard specification that enhances the original “GM” and improves Song data compatibility. It provides for increased polyphony, greater Voice selection, expanded Voice parameters, and integrated effect processing.

■ XG

XG is a major enhancement of the GM System Level 1 format, and was developed by Yamaha specifically to provide more Voices and variations, as well as greater expressive control over Voices and effects, and to ensure compatibility of data well into the future.

■ GS

GS was developed by the Roland Corporation. In the same way as Yamaha XG, GS is a major enhancement of the GM specifically to provide more Voices and Drum kits and their variations, as well as greater expressive control over Voices and effects.

■ XF

The Yamaha XF format enhances the SMF (Standard MIDI File) standard with greater functionality and open-ended expandability for the future. This instrument is capable of displaying lyrics when an XF file containing lyric data is played.

■ SFF GE (Guitar Edition)

“SFF (Style File Format)” is an original Style file format by Yamaha which uses a unique conversion system to provide high-quality automatic accompaniment based on a wide range of chord types. “SFF GE (Guitar Edition)” is an enhanced format of SFF, which features improved note transposition for guitar tracks.

About the Manuals

This instrument has the following documents and instructional materials.



Supplied with the instrument

■ Owner's Manual (this book)

Explains the basic operations and functions of this instrument. Please read this manual first.



Available on the website

■ Reference Manual (only in English, French, German and Spanish)

Explains advanced functions and operations for each icon shown in the Menu display (page 28). Please read this manual after reading the Owner's Manual.

■ Data List

Contains various important preset content lists such as Voices, Styles, etc., as well as MIDI-related information of this instrument.

■ Smart Device Connection Manual

Explains how to connect the instrument to a smart device such as smartphone or tablet, etc.

■ Computer-related Operations

Includes instructions on connecting this instrument to a computer, and other operations.

To obtain these manuals, access the Yamaha website below:

Yamaha Downloads

<https://download.yamaha.com/>

Enter the model name for searching the desired manuals.



Included Accessories

- Owner's Manual (this book)
- "50 Classical Music Masterpieces" (Music Book)
- Online Member Product Registration
- Power cord
- Bench*

* May not be included depending on your area. Check with your Yamaha dealer.

Contents

PRECAUTIONS.....	5
NOTICE.....	7
Information	7
Compatible formats for this instrument	8
About the Manuals	9
Included Accessories	9
Welcome to the World of CVP!	12
Panel Controls	14
Starting Up	16
Opening/Closing the Key Cover.....	16
Using the Music Rest	16
Opening/Closing the Lid (CVP-909 Grand Piano type).....	17
Power Supply	18
Turning the Power On/Off	19
Adjusting the Master Volume	20
Using Headphones.....	20
Making Basic Settings.....	22
Changing the Brightness of Display	23
1 Basic Operations	24
Display Structure	24
Display Configuration	26
Closing the Current Display	28
Display-based Controls	29
Using the ASSIGNABLE Buttons	31
File Management	32
Entering Characters	36
Using the Pedals	38
Using the Metronome.....	39
Adjusting the Tempo	39
Setting the Touch Sensitivity of the Keyboard	40
Transposing the Pitch in Semitones.....	41
Adjusting the Volume Balance	42
Restoring the Factory-programmed Settings (Initializing)	42
Data Backup.....	43
2 Piano Room – Enjoying the Piano Performance –	44
Playing a Piano Performance in the Piano Room	44
Playing the Piano in Session with Other Instruments	45
Changing/Resetting the Piano Room Settings.....	47
Recording your Performance in the Piano Room.....	48
3 Voices – Playing the Keyboard –	49
Playing Preset Voices	49
Setting the Split Point.....	54
Playing Super Articulation Voices	55
Creating Original Organ Flutes Voices.....	56

4	Styles – Playing Rhythm and Accompaniment –	58
	Playing with a Style	58
	Style Control Operations	60
	Calling up Panel Settings Appropriate for the Current Style (One Touch Setting)	63
	Changing the Chord Fingering Type	65
5	Song Playback – Playing and Practice Songs –	67
	Playback of Songs	67
	Displaying Music Notation (Score)	70
	Displaying Lyrics	71
	One-handed Practice with the Guide Function	72
	Repeat Playback	73
	Adjusting the Pitch in Semitones (Pitch Shift)	74
	Adjusting the Playback Speed (Time Stretch)	75
	Canceling the Vocal Part (Vocal Cancel)	75
6	Song Recording – Recording Your Performance –	76
	Basic Procedure for Recording (MIDI/Audio Recording)	76
	Independently Recording the Right- and Left-hand Parts (MIDI Recording)	79
	Recording to Specific Channels (MIDI Recording)	82
	Converting a MIDI Song to an Audio Song	85
7	Microphone – Adding Vocal Harmony Effects to Your Singing –	86
	Connecting a Microphone	86
	Applying Vocal Harmony Effects to Your Voice	87
8	Registration Memory/Playlist – Saving and Recalling Custom Panel Setups –	89
	Saving and Recalling Custom Panel Setups with Registration Memory	90
	Using Playlists to Manage a Large Repertoire of Panel Setups	94
9	Mixer – Editing the Volume and Tonal Balance –	98
	Basic Procedure for the Mixer	98
	Turning Each Channel of the Style or MIDI Song On/Off	100
10	Connections – Using Your Instrument with Other Devices –	101
	I/O Connectors	101
	Connecting USB Devices ([USB TO DEVICE] terminal)	103
	Connecting to a Computer ([USB TO HOST] terminal)	105
	Connecting to a Smart Device ([AUX IN] jack/Bluetooth/[USB TO HOST] terminal/Wireless LAN)	106
	Listening to Audio Playback by the External Device through the Instrument's Speaker ([AUX IN] jack/Bluetooth/[USB TO HOST] terminal)	107
	Using an External Speaker System for Playback (AUX OUT [L/L+R]/[R] jacks)	110
	Connecting External MIDI Devices (MIDI terminals)	111
	Viewing the Instrument's Display on an External Monitor	111
	Connecting a Microphone or Guitar ([MIC/LINE IN] jack)	112
	Connecting a Footswitch/Foot Controller ([AUX PEDAL] jack)	112
	Menu Display Function List	113
	CVP-909 (Grand piano type) Assembly	116
	CVP-909 Assembly	120
	CVP-905 Assembly	124
	Troubleshooting	126
	Specifications	130
	Index	133

Welcome to the World of CVP!

This new CVP model is equipped with a convenient touch screen, enabling visual and intuitive control over virtually all instrument functions. Simply by touching this large and easy-to-see display, you can select desired items, enable and control various features, or edit parameter values—with greater ease and speed than ever before!

The instrument also has many advanced features that enhance your musical enjoyment and expand your creative and performance possibilities. Let's take a look...

True Acoustic Piano Feel

This instrument features gorgeous piano Voices, created with samples of the Yamaha CFX flagship concert grand piano and the famous Bösendorfer* concert grand piano, as well as the GrandTouch Keyboard and GrandTouch Pedal mechanisms which reproduce the authentic touch and feel of an actual grand piano, and provide exceptionally expressive control from pianissimo to fortissimo. The instrument also features VRM technology which accurately recreates the acoustic resonance of a grand piano, which changes subtly by the timing and strength of the player's touch and pedal operation. This enables expression of even the most delicate performance nuances and responds minutely to your pedal use and key playing. Moreover, advanced technologies such as Binaural Sampling give you the impression of being thoroughly immersed in the sound, as if it was actually emanating from the piano—even when listening to the sound through headphones.

When you want to immerse yourself in piano performance with the features above, we recommend that you use the Piano Room. Piano Room lets you select the desired piano type as well as different room ambiences—enabling a complete, realistic piano experience, as if you were playing an actual piano. What's more, you can play along with other virtual "session" players, and enjoy a convincing band-like performance experience with other musical instruments.

* Bösendorfer is a subsidiary company of Yamaha.



▶▶▶ Page 44

Play in Various Music Genres

Naturally, the CVP provides many realistic piano Voices for your playing enjoyment. But it also features a wide variety of authentic instruments, both acoustic and electronic, including organ, guitar, sax, and others used in many music genres—letting you convincingly perform in any desired music style. Moreover, the special Super Articulation Voices realistically recreate many of the performance techniques and characteristic sounds generated when an artist plays an instrument. The result is superbly detailed expression—such as the realistic sound of finger slides on guitar, and the expressive breath noises of saxophone and other wind instruments.

▶▶▶ Page 49

Full Backing Band Accompaniment

Even if you're playing alone, the CVP can put an entire backing band behind you! Simply playing chords automatically triggers and controls the auto accompaniment backing (Style function). Select an accompaniment Style—such as pop, jazz, Latin, and various other music genres in the world—and let the Clavinova be your complete backing band! You can change arrangements on the fly, instantly selecting different rhythm variations and breaks in real time, including Intro, Ending, and Fill-in, during your performance.



▶▶▶ Page 58

Enjoyable Song Lesson Features—with Score Display and Guide Lamps

The Lesson features are a fun way to learn and master Songs, with notation shown on the display. Moreover, each key of the keyboard has a guide lamp, which lights to indicate the notes to be played, letting you practice melodies and phrases smoothly—even if you are a beginner or have trouble reading notation.

▶▶▶ Page 72

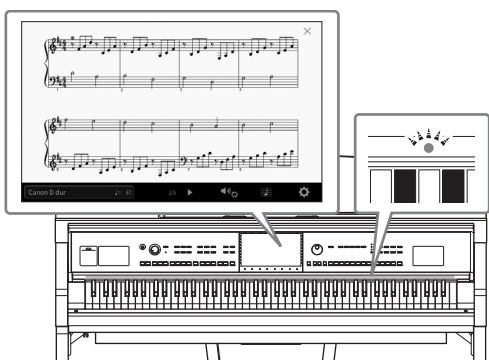

Sing Along with Song Playback or Your Own Performance

Since a microphone can be connected to the Clavinova and Song lyrics can be shown on the display, you can enjoy singing along with your keyboard performance or along with Song playback. Moreover, a powerful Vocal Harmony effect automatically applies lush, authentic sounding vocal harmonies to your singing voice. You can also cancel the vocal part on audio recordings, letting you sing along with (or instead of!) your favorite artists and groups, and enjoy performing even more.

▶▶▶ Pages 71, 86

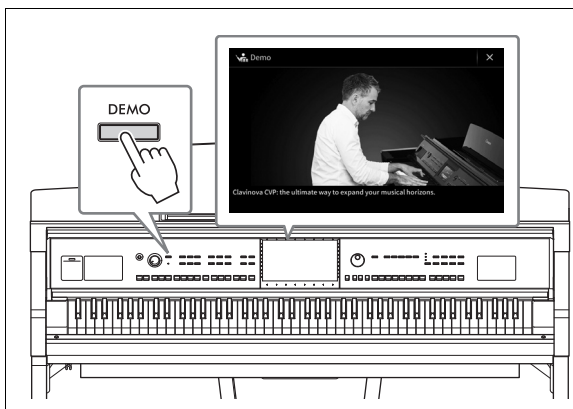

Want to learn more about the Clavinova's features? Press the [DEMO] button and start the demonstration!
 To stop the demonstration, press the [HOME] button located at right of the display.

Panel Controls

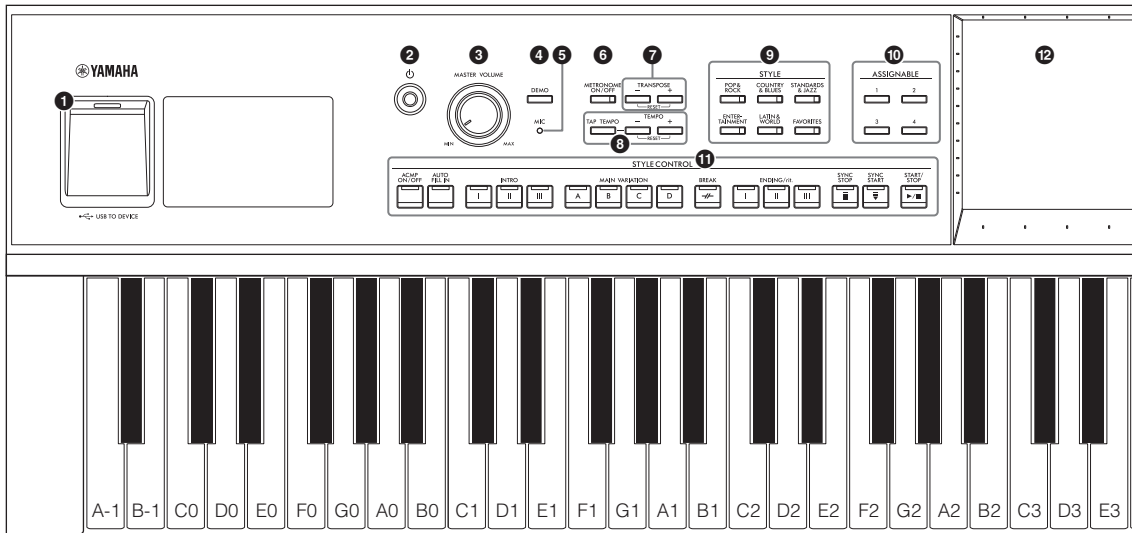

Panel Setup (Panel Settings)

These settings of the instrument made by using the controls on the panel are together referred to as “panel setup” or “panel settings” in this manual.

- | | |
|--|---|
| <ul style="list-style-type: none"> ❶ [USB TO DEVICE] terminalpage 103
For connecting a USB flash drive, USB wireless LAN adaptor or USB display adaptor. This terminal is also located at the bottom of the instrument. ❷ [⏻] (Standby/On) switchpage 19
For turning the power on or setting it to standby. ❸ [MASTER VOLUME] controlpage 20
For adjusting the overall volume. ❹ [DEMO] buttonpage 13
For calling up the Demo display. ❺ [MIC] lamp.....page 86
For checking the input level of the microphone. ❻ [METRONOME ON/OFF] button ...page 39
For turning the metronome on or off. ❼ TRANSPOSE buttonspage 41
For transposing the pitch in semitone steps. ❽ [TAP TEMPO]/TEMPO [-]/[+] buttonspage 39
For controlling the tempo for Style, MIDI Song and metronome playback. ❾ STYLE buttonspage 58
For selecting a Style category. ❿ ASSIGNABLE buttons.....page 31
For assigning shortcuts to often used functions. | <ul style="list-style-type: none"> ⓫ STYLE CONTROL buttons page 60
For controlling Style playback. ⓬ LCD (touch screen) page 24
Allows you to select or change the parameters by simply touching the ‘virtual’ buttons or sliders on the display. ⓭ Data dial page 30
For selecting an item or changing the value. ⓮ [HOME] button page 30
For calling up the Home display, or the first display when the power is turned on. ⓯ [PIANO ROOM] button page 44
For instantly calling up the optimum piano-related settings for playing the instrument simply as a piano. ⓰ SONG CONTROL buttons page 69
For controlling Song playback. ⓱ VOICE buttons page 49
For selecting a keyboard part or a Voice category. ⓲ REGISTRATION MEMORY buttons... page 89
For registering and recalling panel setups. ⓳ ONE TOUCH SETTING buttons page 63
For calling up the appropriate panel settings for the Style. |
|--|---|

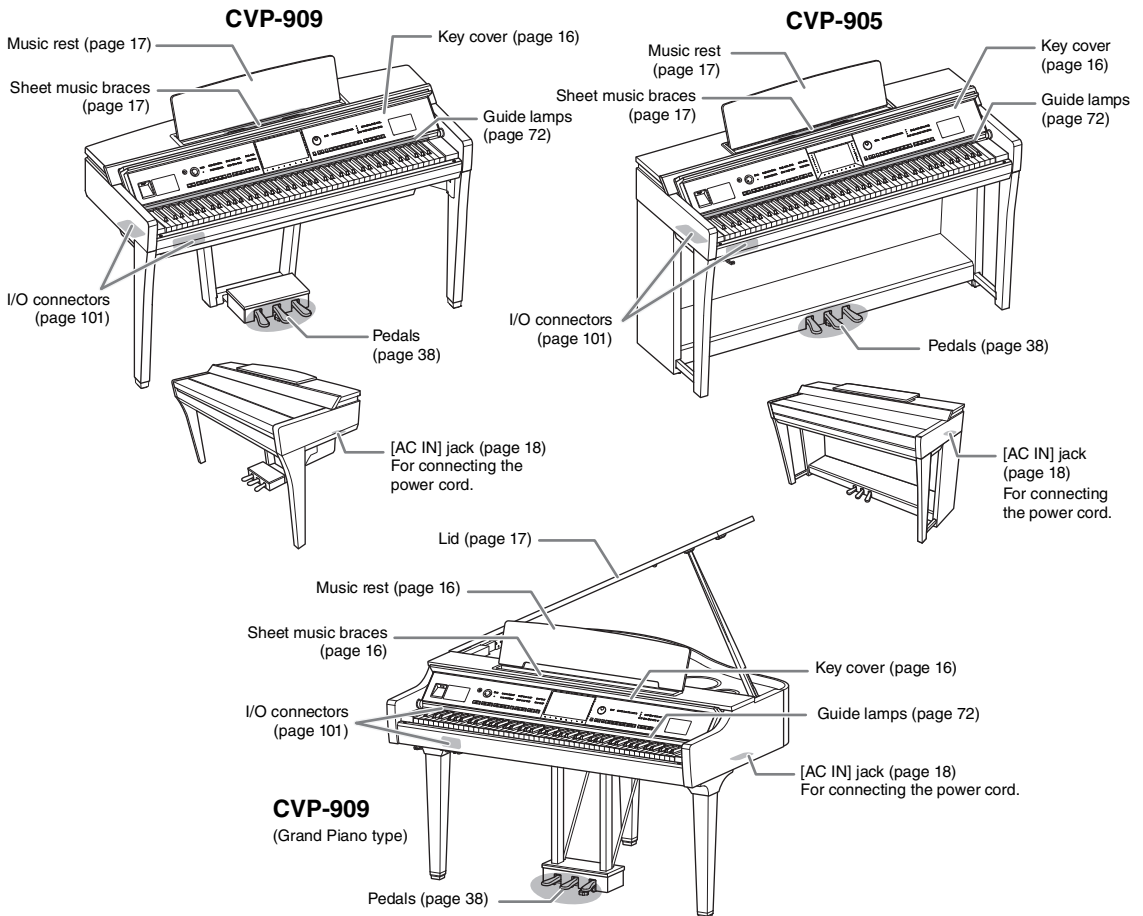
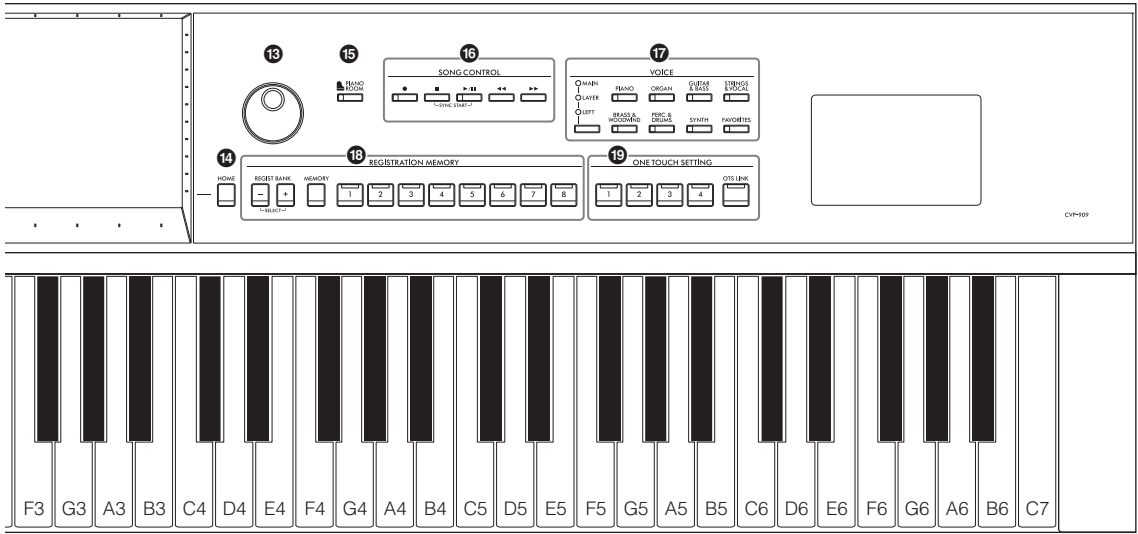

Starting Up

For information on assembling the instrument, refer to the instructions on pages 116, 120 or 124.

Opening/Closing the Key Cover

To open the key cover, hold the hand grip with both hands, and then lift the key cover slightly, and push it up and back.

To close the key cover, lower the key cover back in place gently with both hands.

CAUTION

Be careful to avoid catching your fingers when opening/closing the cover.

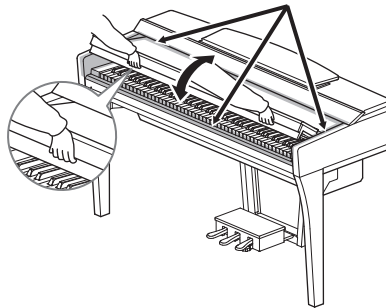

CAUTION

- Hold the cover with both hands when opening or closing it. Do not release it until it is fully opened or closed. Be careful to avoid catching fingers (yours or others, especially children's) between the cover and the unit.
- Do not place anything (such as metal objects or pieces of paper) on top of the key cover. Small objects placed on the key cover may fall inside the unit when the cover is opened and may be nearly impossible to remove. Once inside, they could cause electric shock, short circuit, fire or other serious damage to the instrument.

Using the Music Rest

CVP-909 Grand Piano type

■ To raise the music rest:

- 1 Pull the music rest up and toward yourself as far as it will go.
- 2 Flip down the two metal supports at the left and right on the rear of the music rest.
- 3 Lower the music rest so that the metal supports latch into place.
- 4 Music braces allow you to hold the pages of music books in place.

CAUTION

Do not try to use the music rest in a half-raised position. Also, when raising or lowering the music rest, do not release your hands from the music rest until it is all the way up or down.

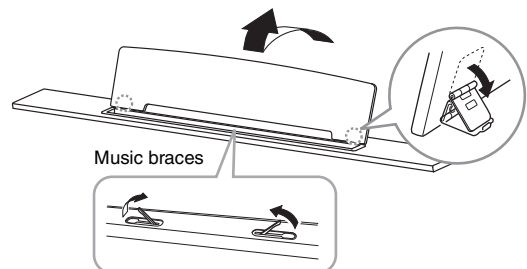

■ To lower the music rest:

Close the Music braces if they are open, and then lower the music rest by following the instructions below.

- ❶ Pull the music rest toward yourself as far as it will go.
- ❷ Raise the two metal supports (at the rear of the music rest).
- ❸ Gently lower the music rest backward until it is all the way down.

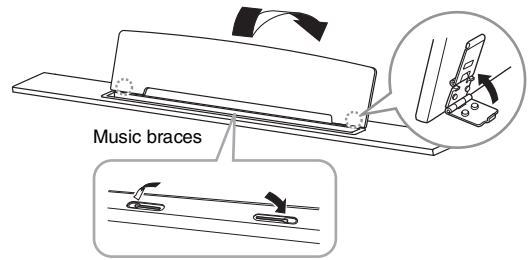

CVP-909/CVP-905

Pull the music rest toward yourself as far as it will go. When raised, the music rest locks in place at a certain angle and cannot be adjusted. The braces allow you to hold the pages of music books in place.

⚠ CAUTION

When raising or lowering the music rest, do not release your hands from the music rest until it is all the way up or down.

To lower the music rest, close the sheet music braces, and then lift the music rest slightly, and turn it back slowly.

⚠ CAUTION

Before lowering the music rest, close the sheet music braces. Otherwise you may catch your fingers between the music rest and the music braces and injure them.

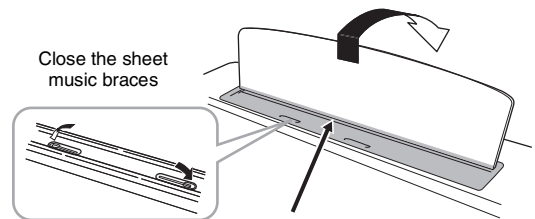
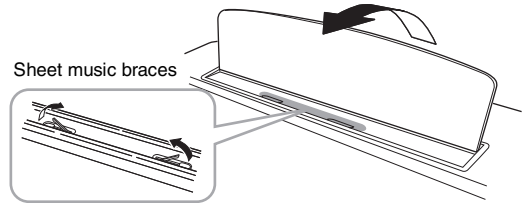

⚠ CAUTION

Be careful to avoid catching your fingers.

Opening/Closing the Lid (CVP-909 Grand Piano type)

One long stay and one short stay are provided on the lid. Use one of them to hold the lid open at the desired angle.

Opening the Lid

- ❶ Raise the music rest.
- ❷ Raise and hold the right side of the lid (viewed from the keyboard end of the instrument).
- ❸ Raise the lid stay and carefully lower the lid so that the end of the stay fits into the recess in the lid.

⚠ CAUTION

Do not let children open or close the lid. Also, be careful to avoid catching fingers (yours or others, and especially those of children) when raising or lowering the lid.

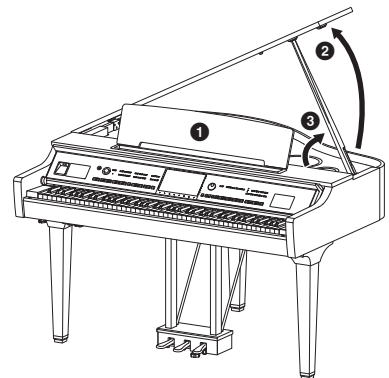

For the longer stay, use the inner recess, and for the shorter stay, use the outer recess to support the lid.

⚠ CAUTION

- Do not use the outer recess for the longer stay. Doing so makes the lid unstable and may cause it to fall, resulting in damage or injury.
- Make sure that the end of the stay fits securely in the lid recess. If the stay is not properly seated in the recess, the lid may fall, causing damage or injury.
- Be careful that you or others do not bump the stay while the lid is raised. The stay may be bumped out of the lid recess causing the lid to fall.

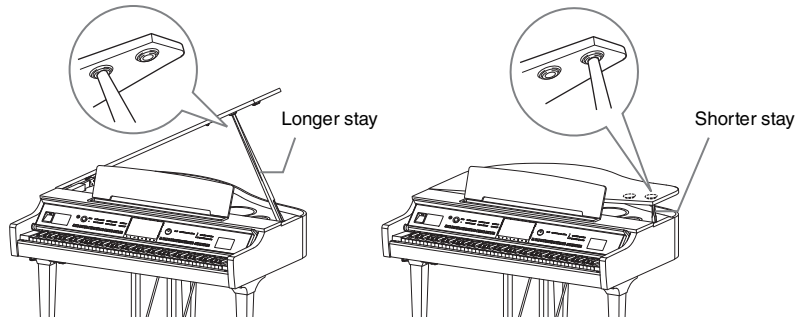

Closing the Lid

- 1 Hold the lid stay and carefully raise the lid.
- 2 Continue to hold the lid in its raised position and lower the lid stay.
- 3 Carefully lower the lid.

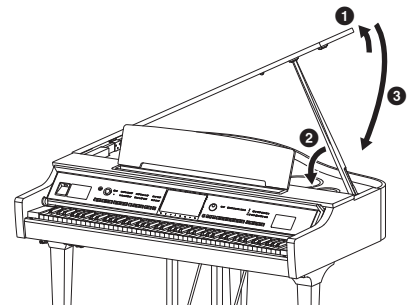

Power Supply

Connect the plugs of the power cord in the order shown in the illustration.

In some areas a plug adaptor may be provided to match the pin configuration of the AC wall outlets in your area.

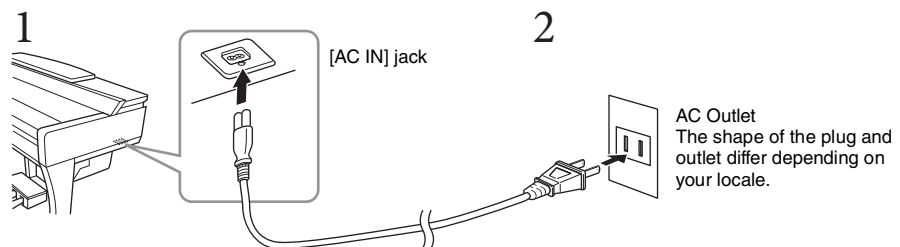

⚠ WARNING

- Use only the supplied power cord. Do not use the power cord for other products.
- When setting up the product, make sure that the AC outlet you are using is easily accessible. If some trouble or malfunction occurs, immediately turn off the power switch and disconnect the plug from the outlet.

NOTE

When disconnecting the power cord, first turn off the power, and then follow this procedure in reverse order.

Turning the Power On/Off

1 Turn down the [MASTER VOLUME] control to “MIN.”

2 Press the [⏻] (Standby/On) switch to turn the power on.

The [MIC] lamp located at right of the [MASTER VOLUME] control and the display light up. After a while, the Home display (page 26) is shown and the instrument starts up. Adjust the volume as desired while playing the keyboard.

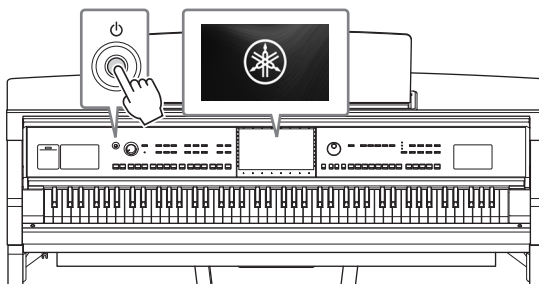

NOTE

Before the Home display is shown, no sound is emitted when the keys are pressed. Moreover, the power does not turn off even when the [⏻] (Standby/On) switch is pressed in this condition.

3 Press and hold the [⏻] (Standby/On) switch for about a second to turn the power off.

⚠ CAUTION

Even when the [⏻] (Standby/On) switch is in standby status, electricity is still flowing to the instrument at the minimum level. Remove the electric plug from the outlet when the instrument is not to be used for extended periods of time, or during electrical storms.

NOTICE

While recording or editing, or while a message is displayed, the power cannot be turned off even if you press the [⏻] (Standby/On) switch. If you want to turn off the power, press the [⏻] (Standby/On) switch after recording, editing, or after the message has disappeared. If you need to force-quit the instrument, hold down the [⏻] (Standby/On) switch for longer than three seconds. Note that the force-quit operation might cause data loss and damage to the instrument.

Auto Power Off function

To prevent unnecessary power consumption, this instrument features an Auto Power Off function that automatically turns the power off if the instrument is not operated for a specified period of time. The amount of time that elapses before the power is automatically turned off is approximately 30 minutes by default; however, you can change the setting (page 22).

NOTICE

Any data which is not saved via the Save operation will be lost if the power automatically turns off. Make sure to save your data before this happens.

Disabling Auto Power Off (simple method)

Turn the power on while holding down the lowest key on the keyboard. An “Auto power off disabled” message appears briefly and Auto Power Off is disabled.

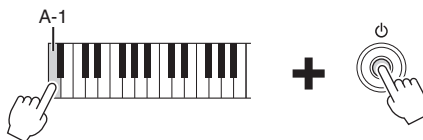

Adjusting the Master Volume

To adjust the volume of the entire keyboard sound, use the [MASTER VOLUME] control while playing the keyboard.

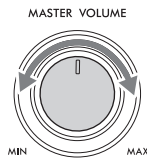

CAUTION

Do not use the instrument for a long period of time at a high or uncomfortable volume level, since this can cause permanent hearing loss.

Intelligent Acoustic Control (IAC)

IAC is a function which automatically adjusts and controls the sound quality according to the overall volume of the instrument. Even when the volume is low, it permits both low sounds and high sounds to be clearly heard. IAC Control affects only the sound output of the instrument speakers. The default setting for this function is on. You can turn the IAC setting on or off, and set the depth. For details, refer to the “Utility” section in the Reference Manual on the website (page 9).

Using Headphones

Connect a pair of headphones to the [PHONES] jack. Since this instrument is equipped with two [PHONES] jacks, you can connect two pairs of headphones. If you are using only one pair, insert the plug into either of these jacks.

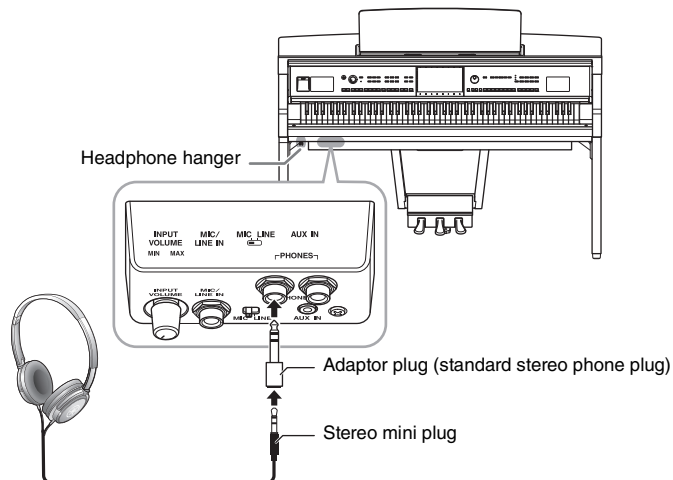

CAUTION

Do not use the headphones for a long period of time at a high or uncomfortable volume level, since this can cause permanent hearing loss.

NOTE

If you are using an adaptor plug, be sure to remove this as well when unplugging the headphones. No sound will come out of the instrument's speakers if the adaptor plug is left connected.

Reproducing a Natural Sound Distance Sensation (even when using Headphones)—Binaural Sampling and Stereophonic Optimizer

This instrument features two advanced technologies that allow you to enjoy exceptionally realistic, natural sound, even though listening on headphones.

■ Binaural Sampling

Binaural Sampling is a method that uses two special microphones set at the ear position of a performer and records the sound from a piano as it would actually be heard. Listening to the sound with this effect through headphones gives the impression of being immersed in the sound, as if it was actually emanating from the piano. Moreover, you can enjoy the sound naturally for a long time without ear fatigue. When the “CFX Concert Grand” or “Bösendorfer Grand” Voice is selected, connecting the headphones automatically enables the binaural sampling sound.

Sampling

A technology which records the sounds of an acoustic instrument then stores them to the tone generator to be played based on information received from the keyboard.

■ Stereophonic Optimizer

Stereophonic Optimizer is an effect which reproduces the natural sound distance, like with the sound of Binaural Sampling, even though you are listening to it on headphones. When one of the VRM Voices (page 53) other than “CFX Concert Grand” or “Bösendorfer Grand” is selected, connecting the headphones automatically enables the Stereophonic Optimizer.

When headphones are connected, the VRM Voices (page 53) automatically change to the sound of Binaural Sampling or the sound enhanced with the Stereophonic Optimizer, by the default settings. However, when headphones are connected, these functions also affect the sound from the external speaker connected to the AUX OUT jacks or the sound for Audio recording (page 76), and may result in unusual or unnatural sound. If this happens, turn this function off.

You can turn this function on or off on the display called up via [Menu] → [Utility] → [Speaker/Connectivity]. For details, refer to the Reference Manual on the website (page 9).

Using the Headphone Hanger

A headphone hanger is included in the instrument package so that you can hang the headphones on the instrument. Install the headphone hanger by following the instructions on pages 119, 122 or 125.

NOTICE

Do not hang anything other than the headphones on the hanger. Otherwise, the instrument or the hanger may be damaged.

Making Basic Settings

As necessary, make basic settings for the instrument, such as the language shown on the display.

1 Call up the operation display (Utility).

First, touch [Menu] at the bottom right corner of the Home display which is shown when the power is turned on. Then touch [▶] to move to page 2 (if necessary), and touch [Utility].

2 Touch [System] on the display.

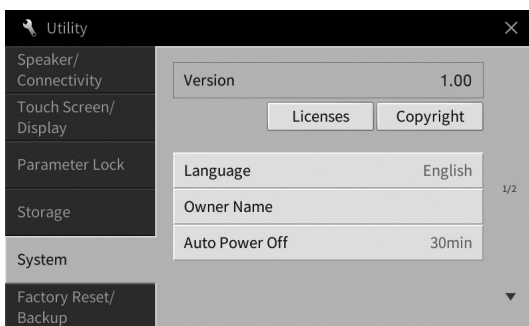

3 Make the necessary settings by touching the display.

Version	Indicates the firmware version of this instrument. Yamaha may from time to time update firmware of the product without notice for improvement in functions and usability. To take full advantage of this instrument, we recommend that you upgrade your instrument to the latest version. The latest firmware can be downloaded from the website below: https://download.yamaha.com/
Licenses	Touch here to call up license information of the open source software which is used on this instrument.
Copyright	Touch here to call up copyright information.
Language	Determines the language used in the display for menu names and messages. Touch this setting to call up the language list, and then select the desired one.
Owner Name	Lets you input your name which appears in the opening display (called up when the power is turned on). Touch this setting to call up the character entry window, and then input your name (page 36).
Auto Power Off	Lets you set the amount of time that elapses before the power is turned off by the Auto Power Off function (page 19). Touch this to call up the list of settings, and then select the desired one. To disable Auto Power Off, select "Disabled" here.

For information on page 2/2 of this display, refer to the "Utility" section in the Reference Manual on the website (page 9).

Changing the Brightness of Display

Here you can change certain display settings as desired, including brightness.

- 1 Call up the operation display (Utility) (step 1 on page 22).
- 2 Touch [Touch Screen/Display] on the display.

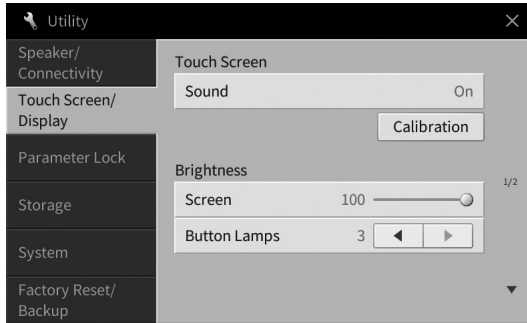

- 3 Change the settings by touching the display.

Touch Screen	Sound	Determines whether or not touching the display will trigger the click sound.
	Calibration	Lets you calibrate the display when it does not respond properly to your touching (Normally, you do not need this operation, since it is calibrated by factory default). Touch here to call up the Calibration display, then touch the center of the plus marks (+) in order.
Brightness	Screen	Move the slider to adjust the brightness of the display.
	Button Lamps	Touch [◀/▶] to adjust the brightness of the button lamps on the control panel. NOTE The brightness of the guide lamps cannot be adjusted.

For information on the other items in this display, refer to the “Utility” section in the Reference Manual on the website (page 9).

1 Basic Operations

Display Structure

Turning on this instrument calls up the Home display, from which you can call up the File Selection display and Menu display, providing you convenient access to various functions and allowing you to make various settings. For detailed instructions on the display, refer to page 26.

File Selection display (page 27)

You can call up the desired type of display by touching the Style name, Voice name or Song name on the Home display.

Style Selection display

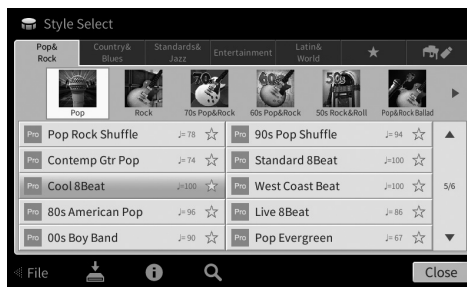

Voice Selection display

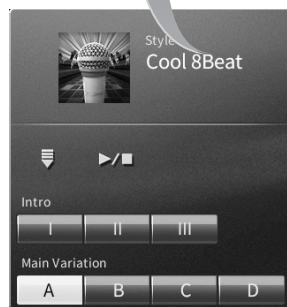

Touch here to expand.



By expanding the Style area, you can call up the playback-related controls on the display.

Home display (page 26)

This is the portal or home base of the instrument's display structure.

Menu display (page 28)

By touching each of the icons, you can call up various functions, such as Song Score, Volume Balance and other detailed settings.

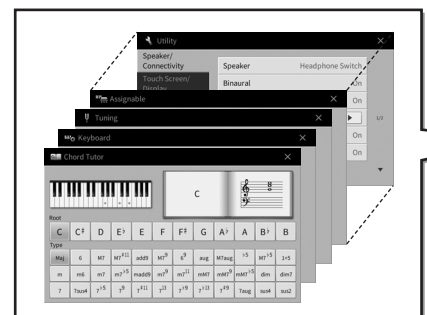

Song Selection display

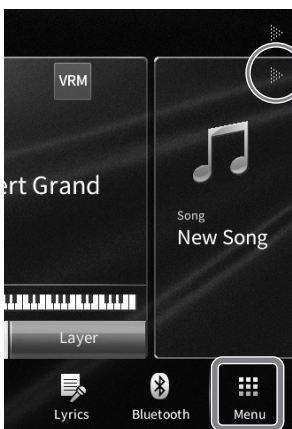
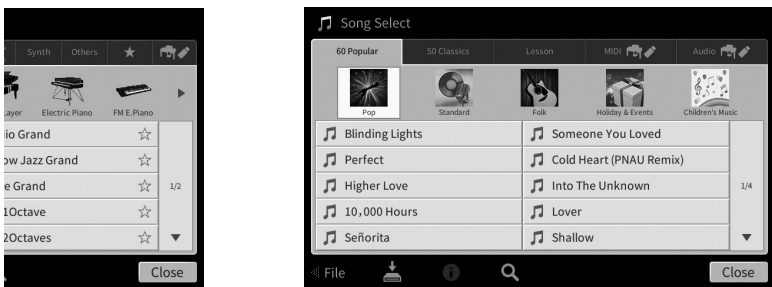

Touch here to expand.

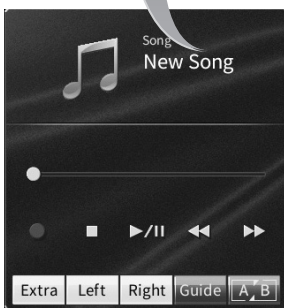

By expanding the Song area, you can call up the playback-related controls on the display.

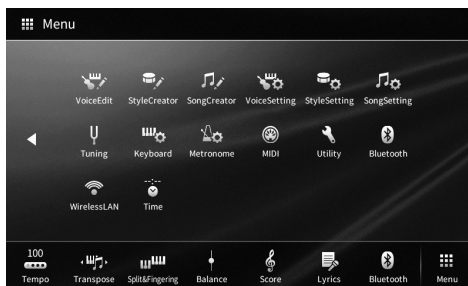
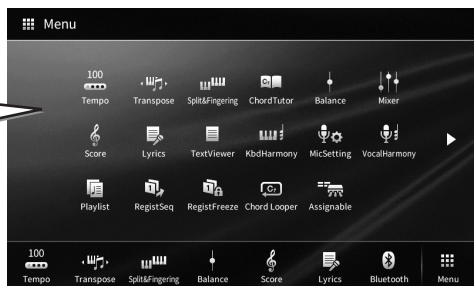

Display Configuration

This section covers the most often used displays: Home, File Selection and Menu. The Home display appears when the power is turned on. The File Selection display and Menu display can be called up from the Home display.

Home Display

Appears when the power is turned on, and can be called up when the [HOME] button is pressed. This display shows the current basic settings such as the current Voice and Style, allowing you to see them at a single glance. Because of this, you should normally have the Home display shown when you perform on the keyboard.

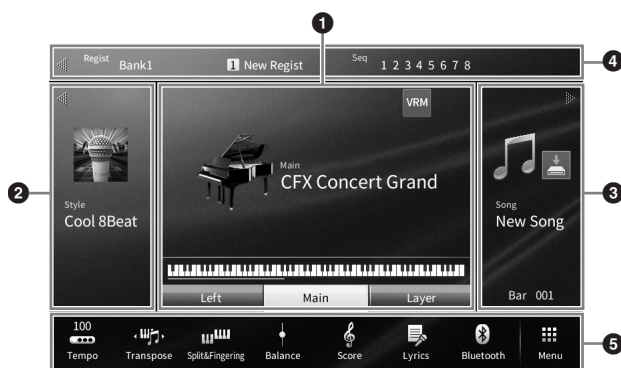

1 Voice area

Indicates the current Voices for each of the keyboard parts (Main, Left and Layer) and the on/off status of these parts (page 49). Touching a Voice name calls up the Voice Selection display.

NOTE

On the Voice area, Style area or Song area, flicking right expands the Style area, while flicking left expands the Song area.

2 Style area

Indicates the current Style (page 58). Touching a Style name calls up the Style Selection display. Touch [◀] at the upper left of this area to expand the area. To reset the area to the default status, touch [▶], which appears at the upper right of the Voice area.

3 Song area

Indicates the current Song (page 67). Touching a Song name calls up the Song Selection display. Touch [▶] at the upper right of this area to expand the area. To reset the area to the default status, touch [◀], which appears at the upper left of the Voice area.

If a recorded or edited Song exists but has not yet been saved,  (Save) is shown. Touching it calls up the display for saving the data (page 32).

4 Registration area

Indicates the currently selected Registration Memory Bank name, Registration name and Registration Sequence when it is active (page 90). Touching this area calls up the Registration Bank Selection display. You can hide or show this area by touching [◀] or [▶] in the area.

NOTE

Flicking right or left on the Registration area can also hide or show this area.

5 Menu area

Contains the shortcut icons which let you call up various functions with a single touch. Touching a shortcut icon will call up the display of the corresponding function. Touch [Menu] icon at the right end to call up the Menu display (page 28), from which you can register shortcut icons as desired here.



File Selection Display

The File Selection display is for selecting a Voice, Style, Song, and other data. You can call up this display by touching the name of the Voice, Style or Song on the Home display, or by pressing one of the VOICE or STYLE buttons, etc.



1 Category

A wide variety of data such as Voices and Styles are divided into several categories (tabs) according to the data type. Except for the following two, all tabs are referred to as “preset” tabs, since they contain preset data.

 (Favorite tab)	Location where the Voices or Styles which you have registered as Favorites are shown (page 35). This tab is available only for Voices and Styles.
 (User tab)	Location where recorded or edited data is saved. Data saved to the instrument are shown in “USER” (User memory), while data in the connected USB flash drive are shown in “USB.” In this manual, data in the User tab is referred to as “User data.”

2 Sub Category / Folder (Path)

- When one of the preset tabs is selected, the sub categories are shown here according to the data type. For example, various piano types such as Grand Piano and Electric Piano are shown when you touch the “Piano” tab on the Voice Selection display.
- When the Favorite tab is selected, this is not available.
- When the User tab is selected, the current path or folder is shown here according to the folder structure.

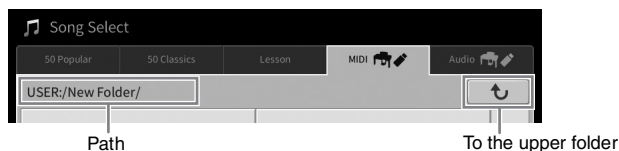

3 Selectable data (files)

The files that can be selected are shown. If two or more pages are available, you can call up another page by touching [▲] or [▼] at the right.

NOTE

You can call up another page also by flicking vertically on the list.

4 Operation icons

The functions (save, copy, delete, etc.) which can be operated via the File Selection display are shown. The icons shown here differ depending on which File Selection display is selected. For detailed instructions, refer to pages 32 – 36, or the instructions for each function’s File Selection display.

Menu Display

This is the portal display for using various functions and can be called up by touching the [Menu] icon at the bottom right corner of the Home display.



1 Function list

Various convenient functions are shown via icons. Touching each of them calls up the corresponding function. This list consists of two pages, which you can select by pressing [▶] or [◀]. For information on each function, refer to the “Menu Display Function List” (page 113) or the Reference Manual on the website (page 9).

NOTE

You can also change pages by flicking horizontally.

2 Shortcuts

By registering often used functions here as Shortcuts, you can call up them quickly from the Menu area of the Home display. To register as a Shortcut, first touch and hold the icon on the Function list until the Shortcut list changes color, then touch the desired location for entering the function. For details, refer to the “Contents” in the Reference Manual on the website (page 9).

Instruction conventions for the Menu display

Throughout this manual, instructions with multiple steps are given in convenient shorthand, with arrows indicating the proper sequence.

Example: [Menu] → [Utility] → [System] → [Language]

The example above describes a three step operation:

- 1) From the Menu display, touch [Utility].
- 2) Touch [System].
- 3) Touch [Language].

Closing the Current Display

To close the current display, touch [x] at the upper right of the display (or window) or [Close] at the lower right of the display (or window). When a message (information or confirmation dialog) appears, touching the appropriate item such as “Yes” or “No” closes the message.

If you want to quickly return to the Home display press the [HOME] button on the panel.

Display-based Controls

The display of this instrument is a special touch screen that allows you to select or change the desired parameter by simply touching the corresponding setting on the display. The Data dial and the [HOME] button can also be used.



Using the Display (Touch Screen)

NOTICE

Do not use any sharp or hard tools to operate the touch screen. Doing so may damage the display.

NOTE

Keep in mind that operation by simultaneously touching two or more points on the display is not possible.

Touch

To select an item, lightly touch the corresponding indication on the display.

NOTE

You can turn on/off system sounds produced when touching the display (page 23).

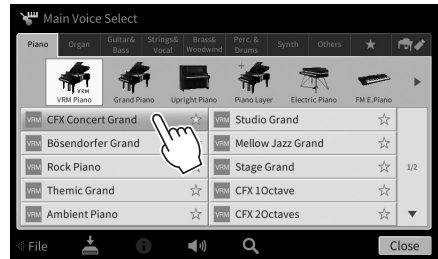

Slide

Hold down the display slider, then slide your finger vertically or horizontally to change the parameter value.

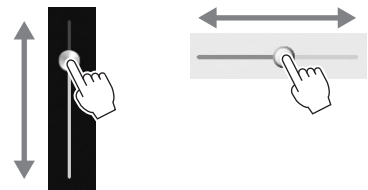

Slide your finger vertically or horizontally on the display to turn pages, or to show or hide some part of a particular display.

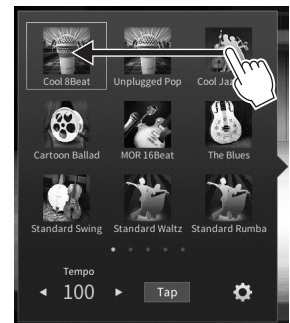

■ Rotate

Touch and hold the display knob, and rotate your finger around the knob to change the parameter value.

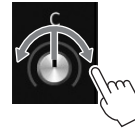

■ Touch and hold

This instruction means to touch the object in the display and hold it for a while.

When setting values by using [◀]/[▶], a slider or a knob, you can restore the default value by touching and holding the value on the display.



Rotating the Data Dial

Depending on the display, the Data dial can be used in the following two ways.

■ Adjusting the parameter values

After selecting the desired parameter, use the Data dial to adjust the value. This is useful if you have difficulty adjusting by touching on the display, or want finer control over the adjustment.



■ Selecting an item from a list

In File Selection displays (page 27) and the List windows for setting parameters, use the Data dial to select an item.

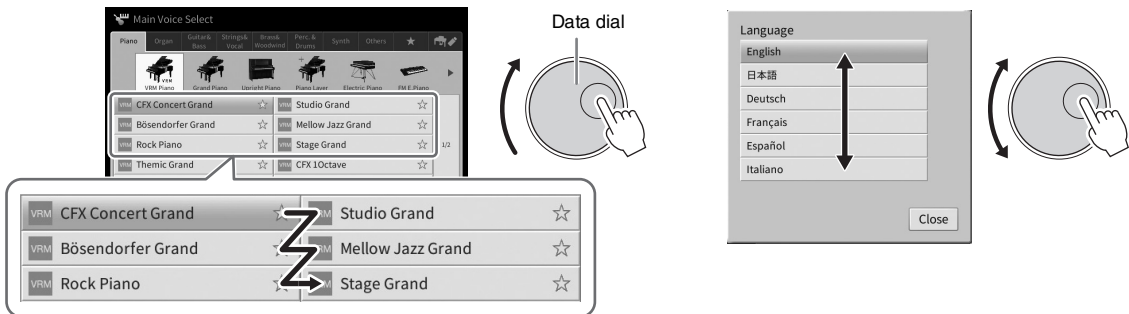

Pressing the [HOME] Button

You can quickly return to the Home display (the display shown when the power is turned on) by pressing the [HOME] button whenever you want.



Using the ASSIGNABLE Buttons

You can assign the functions which you use frequently to these four panel buttons at the left side of the display. Also, any of the functions listed on the Menu display (page 28) can be assigned here as a shortcut.

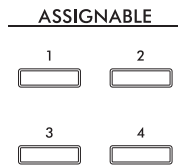

- 1 Call up the operation display via [Menu] → [Assignable] → [Assignable].

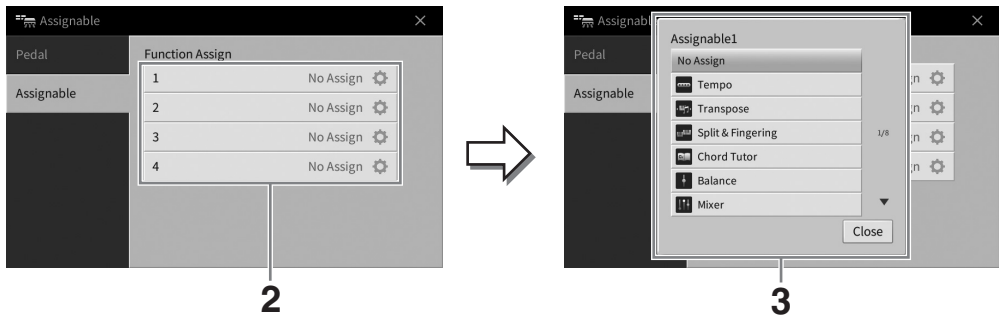

- 2 Touch the desired button number to call up the list.
- 3 Select the desired item from the functions and shortcuts (equivalent to the functions in the Menu display).

NOTE

For details about the functions which can be assigned to these buttons, refer to the Reference Manual on the website (page 9).

File Management



Data you have created such as recorded Song and edited Voice can be saved as files to the instrument (referred to as “User memory”) and a USB flash drive. If you’ve saved a lot of files, you may have trouble finding the desired file quickly. To make operation easier, you can organize your files in folders, or you can use the search function. These operations are done in the File Selection display.

NOTE

Before using a USB flash drive, be sure to read “Connecting USB Devices” on page 103.

Saving a File

You can save your original data (such as Songs you’ve recorded and Voices you’ve edited) as a file to the instrument or USB flash drive.

- 1 In the relevant display, touch  (Save) to call up the display for selecting the saving destination.**
- 2 Select the location to which you want to save the file.**
To show the next higher level folder, touch  (Above).
You can create a new folder by touching  (New Folder).



- 3 Touch [Save here] to call up the Character Entry window.**

NOTE

To cancel this operation, touch [Cancel].

- 4 Enter the file name (page 36).**
Even if you skip this step, you can rename the file at any time (page 33) after saving.
- 5 Touch [OK] in the Character Entry window to actually save the file.**
The saved file will be automatically located at the appropriate position among the files in alphabetical order.

Creating a New Folder

Folders can be created, named and organized as desired, making it easier to find and select your original data.

NOTE

- The maximum total number of files/folders which can be saved to the User memory differs depending on the file size and the length of the file/folder names.
- The maximum number of files/folders which can be stored in a folder is 2,500.

1 In the File Selection display, touch the User tab (page 27) then select the location to which you want to create a new folder.

To show the next higher level folder, touch  (Above).

NOTE

You cannot create a new folder in the "Piano Room" folder (page 48).

2 Touch [File] to call up the File Management icons.

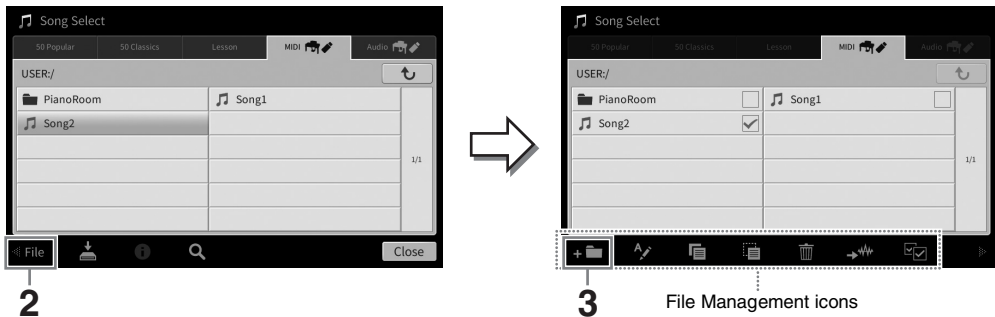

NOTE

- To cancel the file operation, touch  at right corner to hide the File Management icons.
- You can hide or show the File Management icons by flicking the bottom of the display horizontally.

3 Touch (New Folder) to call up the Character Entry window.

4 Input the name of the new folder (page 36).

Renaming a File/Folder

You can rename files/folders.

NOTE

- Files in the Preset tabs cannot be renamed.
- The "Piano Room" folder (page 48) cannot be renamed.

1 Call up the File Selection display, on which the desired file/folder is shown.

2 Touch [File] to call up the File Management icons.

NOTE

- To cancel the file operation, touch  at right corner to hide the File Management icons.
- You can hide or show the File Management icons by flicking the bottom of the display horizontally.

3 Enter a checkmark to the desired file or folder by touching it.

4 Touch (Rename) to call up the Character Entry window.

NOTE

Only one file or folder can be renamed at a time.

5 Input the name of the selected file or folder (page 36).

Copying or Moving Files

You can copy or cut a file and paste it to another location (folder). You can also copy a folder (but not move it) by using the same procedure.

NOTE

- Files in the Preset tabs cannot be moved.
- Copying of commercially available musical data including but not limited to MIDI data and/or audio data is strictly prohibited except for your personal use. Commercially available Song data may be copy protected to prevent illegal copying or accidental erasure.
- Preset Songs copied to the User tab are indicated by  (key icon) at the left side of the Song name on the Song Selection display. These cannot be copied or moved to USB flash drives.



1 Call up the appropriate File Selection display, on which the desired files/folders are shown.

2 Touch [File] to call up the File Management icons (page 33).

NOTE

- To cancel the file operation, touch  at right corner to hide the File Management icons.
- You can hide or show the File Management icons by flicking the bottom of the display horizontally.

3 Enter checkmarks to the desired files/folders by touching each item.

One or more files/folders can be checked. When you want to enter checkmarks to all displayed items, touch  (Check All). Touch  (Check All) again to remove all the checkmarks.

4 Touch  (Copy) or  (Move), to call up the display for selecting the destination.

5 Select the desired destination (path) to paste the files/ folders.

You can create a new folder by touching  (New Folder).

NOTE

To cancel this operation, touch [Cancel] before going to step 6.

6 Touch [CopyHere] or [MoveHere] to paste the files/folders you've selected in step 3.

The pasted file/folder appears on the display at the appropriate position among the files in alphabetical order.

Deleting Files/Folders

You can delete files/folders.

NOTE

- Files in the Preset tabs cannot be deleted.
- The "Piano Room" folder (page 48) cannot be deleted.



1 Call up the appropriate File Selection display, on which the desired files/folders are shown.

2 Touch [File] to call up the File Management icons (page 33).

NOTE

- To cancel the file operation, touch  at right corner to hide the File Management icons.
- You can hide or show the File Management icons by flicking the bottom of the display horizontally.

3 Enter checkmarks to the desired files/folders by touching each item.

One or more files/folders can be checked. When you want to enter checkmarks to all displayed items, touch  (Check All). Touch  (Check All) again to remove all the checkmarks.

4 Touch  (Delete).

5 After the confirmation message appears, touch [Yes] to actually delete the files/ folders you've selected in step 3.

To cancel this operation, touch [No] instead of [Yes].

Registering Files to the Favorite Tab

You can call up your favorite or often used Voices or Styles quickly by registering them to the Favorite tab. Touch the star mark (☆) at the right side of each file to register the corresponding file to the Favorite tab. To remove the registered file from the Favorite tab, touch the colored star mark (★) in the Favorite tab or in the tab which actually contains the corresponding file.

NOTE

- If you change the name of the original file or move/delete the original file, touching the corresponding file name in the Favorite tab cannot call up the file.
- Within the Favorite tab, to actually remove the file, you need to touch the colored star then close or switch the display.



Sorting the File Order in the Favorite Tab

You can change the order of the files such as Voices and Styles in the Favorite tab.

- 1 In the Voice Selection display or Style Selection display, touch the Favorite tab.
- 2 Touch (Order) to call up the Order Edit display.
- 3 Touch the file you want to move.

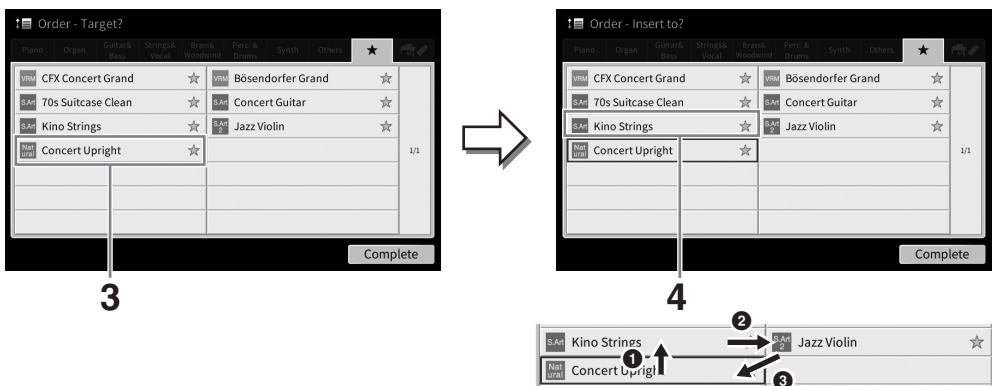

- 4 Touch the location to which you want to move the file selected in step 3.
- 5 Repeat steps 3 – 4 as necessary.
- 6 Touch [Complete] to exit from the Order Edit display.

Searching for Files

- 1 In the File Selection display, touch **Q** (Search) to call up the Search display.
- 2 Touch the Search box to call up the Character Entry window.

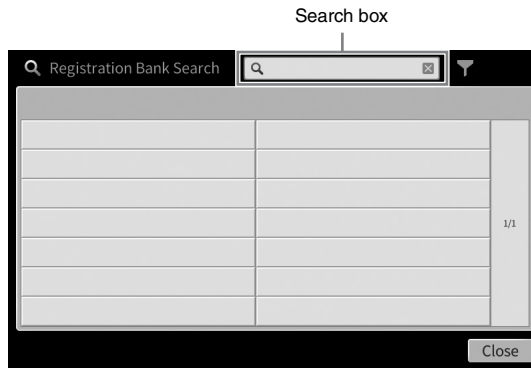

- 3 Enter the file name or the folder name (or just a part of it) to start searching (page 37).

If you want to enter multiple words, insert a space between each word.

After the search is complete, the resulting list appears. If no files are listed, try this step again with another word.

NOTE

On the Registration Bank Selection display, you can narrow the search by filtering. For details, refer to page 92.

- 4 Select the desired file.

After selecting the file, touch the appropriate button such as [OK] or [Add to Playlist] for desired operation. Touching [Cancel] calls up the display which was opened before the Search display was called up.

Entering Characters

This section covers how to enter characters for naming your files/folders and inputting words for searching files. Entering characters is done in the display shown below.



1 Touch the character type.

■ When the Language (page 22) is set to other than Japanese:

Touching [Symbol] (or [abc]) switches between entering symbols or Roman letters (and numbers).
To switch between entering capital letters or small letters, touch  (Shift).

■ When the Language (page 22) is set to Japanese:

- a b c (全角 abc) : Roman letters and numbers in half size (full size)
- 記号 (全角記号) : Symbols in half size (full size)
- カナ (半角カナ) : Katakana in full size (half size)
- かな漢 : Hiragana and Kanji

To switch between full size or half size, touch and hold the Character Type. For example, [半角カナ] can be called up by holding [カナ].

When entering Roman letters, you can switch between capital and small letters by touching  (Shift).

2 Touch [◀]/[▶] or rotate the Data dial to move the cursor to the desired location.

3 Input the desired character one by one.

To delete a single character, touch [Delete]; to delete all characters at once, touch and hold [Delete]. To enter a space, touch the space key indicated in the illustration on the previous page.

NOTE

- Depending on the display for character entry you are working in, some types of characters cannot be entered.
- A file name can contain up to 46 characters and a folder name can contain up to 50 characters.
- The following characters (half size) cannot be used: \ / : * ? " < > |

■ To input letters with auxiliary symbols (when Language is set to other than Japanese):

You can input letters with auxiliary symbols such as umlaut by touching and holding a letter to call up a list. For example, touch and hold “E” to enter “É” from the list.

■ To convert into Kanji (when the Language is set to Japanese):

When the entered “hiragana” characters are shown in reverse display (highlighted), touch [変換] several times to call up the conversion options. You can change the reversed area by touching [◀] or [▶]. When you find the desired Kanji, touch [確定].

To change the converted kanji back to “hiragana,” touch [戻す].

To clear the reversed area at once, touch [キャンセル].

NOTE

To cancel this operation, touch [Cancel] before going on to step 4.

4 Touch [OK] to finalize the characters (file name, etc.) you have input.

Using the Pedals

NOTE

- The pedals are protected with vinyl covers when shipped from the factory. Remove the covers from the pedals before using to ensure optimum use of the pedal effects.
- If the pedal box rattles or gives way when you step on the pedals, turn the adjuster so that it is set firmly against the floor (pages 119, 122, 125).

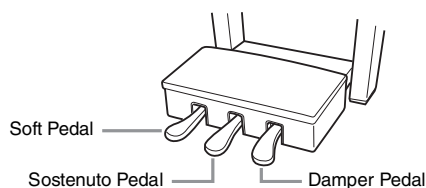

■ Damper Pedal (Right)

Pressing this pedal sustains notes. Releasing this pedal immediately stops (damps) any sustained notes. Pressing this pedal while you play a VRM Voice (page 53) recreates the characteristic string resonance of a real acoustic piano.

NOTE

- Certain Voices, such as strings and brass, sustain continuously when the damper/sostenuto pedal is pressed.
- Certain Voices such as drum kits may not be affected by use of the damper/sostenuto pedal.



If you press and hold the damper pedal here, all the notes shown will be sustained.

Half-pedal function

A “half-pedal” function of the damper pedal creates partial sustain effects, depending on how far down you press the pedal. The farther you press the pedal, the more the sound sustains. For example, if you press the damper pedal and the notes you play sound a bit murky and loud with too much sustain, you can partially release the pedal to lessen the sustain (murkiness).

Since the pressing sensation may vary depending on the situation, including the location where the instrument is installed, you can adjust the half-pedal point to the desired setting on the display called up via [Menu] → [Assignable] → [Pedal]. For details, refer to the Reference Manual on the website (page 9).

GP Response Damper (CVP-909 only)

The damper pedal of the CVP-909 has been designed to provide enhanced tactile response and, when pressed, is much closer in feel to the pedal of an actual grand piano. It makes it easier to physically experience the half-pedal point and more easily apply the half-pedal effect than other pedals.

■ Sostenuto Pedal (Center)

When the Piano Voice is selected, if you play a note or chord on the keyboard and press this pedal while holding the note(s), the notes will sustain as long as the pedal is held. All subsequent notes will not sustain.

When a Voice other than piano is selected, a specific function appropriate for the Voice is automatically assigned to the center pedal.

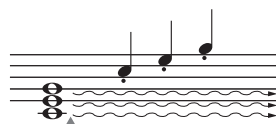

If you press and hold the sostenuto pedal here, only the notes held at this timing will be sustained.

■ Soft Pedal (Left)

When the Piano Voice is selected, pressing this pedal reduces the volume and slightly changes the timbre of the notes you play. When a Voice other than piano is selected, a specific function appropriate for the Voice is automatically assigned to the left pedal.

You can adjust the depth of the Soft pedal effect on the display called up via [Menu] → [Assignable] → [Pedal]. For details, refer to the Reference Manual on the website (page 9).

Assigning a function to each pedal

Various functions can be assigned to each of the three pedals and a foot controller/footswitch (sold separately) — including start/stop of Song playback and controlling a Super Articulation Voice. These can be set on the display called up via [Menu] → [Assignable] → [Pedal]. For details, refer to the Reference Manual on the website (page 9).

Using the Metronome

The [METRONOME ON/OFF] button lets you start or stop the metronome. The metronome provides a click sound, giving you an accurate tempo guide when you practice, or letting you hear and check how a specific tempo sounds.

NOTE

You can also change the time signature, volume and sound of the metronome on the display called up via [Menu] → [Metronome] → [Metronome].

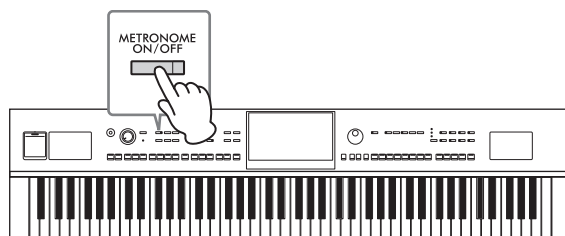

Adjusting the Tempo

The TEMPO [-] and [+] buttons let you change the playback tempo of Metronome, Style and MIDI Song. The tempo of the Style and MIDI Song can also be adjusted via the [TAP TEMPO] button.

NOTE

If you want to adjust the tempo of an Audio Song, use the Time Stretch function on page 75.

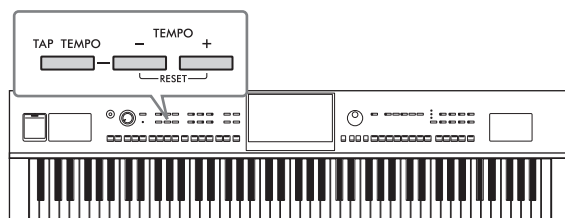

■ TEMPO [-]/[+] buttons

Press the TEMPO [-] or [+] button to call up the Tempo pop-up display. Use the TEMPO [-]/[+] buttons to decrease or increase the tempo over a range of 5 – 500 beats per minute. Holding down either button changes the value continuously. Pressing both TEMPO [-] and [+] buttons calls up the default tempo of the last selected Style or Song.

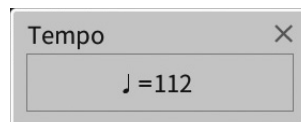

■ [TAP TEMPO] button

During playback of a Style or MIDI Song, you can change the tempo by tapping the [TAP TEMPO] button twice at the desired tempo. When Style and Song are stopped, tapping the [TAP TEMPO] button (four times for a 4/4 time signature) starts playback of the rhythm part of the Style at the tempo you tapped.

NOTE

You can change the sound type or volume of the sound caused when tapping the [TAP TEMPO] button via [Menu] → [Metronome] → [Tap Tempo].

Setting the Touch Sensitivity of the Keyboard

Touch Sensitivity determines how the sound responds to your playing strength. This setting does not change the weight of the keyboard.

1 Call up the display via [Menu] → [Keyboard].

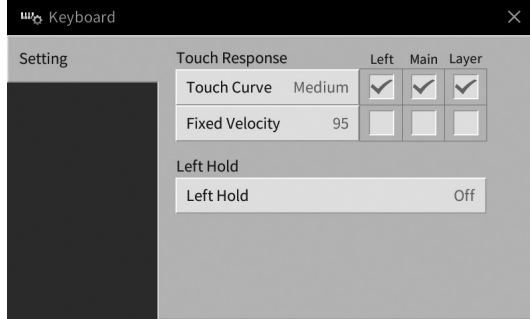

2 Make the settings by touching the display.

<p>Touch Curve</p>	<p>Enter checkmarks to the boxes of the desired keyboard parts, then touch here to call up the setting window and select the Touch Sensitivity type. If you remove the checkmark, playing the corresponding part will produce a fixed velocity regardless of your playing strength.</p> <p>NOTE The Touch Sensitivity settings may have no effect with certain Voices.</p> <ul style="list-style-type: none"> • Hard2: Requires strong playing to produce high volume. Best for players with a heavy touch. • Hard1: Requires moderately strong playing for high volume. • Medium: Standard Touch Sensitivity. • Soft1: Produces high volume with moderate playing strength. • Soft2: Produces relatively high volume even with light playing strength. Best for players with a light touch.
<p>Fixed Velocity</p>	<p>Make sure that the box of the desired keyboard parts are checked, and then touch here to call up the setting window and set the velocity with which you play the keys, which stays fixed regardless of your playing strength.</p>

For details on the Left Hold function, refer to page 52.

Transposing the Pitch in Semitones

The TRANSPOSE [-]/[+] buttons transpose the overall pitch of the instrument (the keyboard sound, Style playback, MIDI Song playback, and so on) in semitone steps (from -12 to 12). Pressing the [-] and [+] buttons simultaneously resets the value to 0.

NOTE

- If you want to transpose the pitch of the Audio Song, use the Pitch Shift parameter on page 74.
- The Transpose functions do not affect the Drum Kit or SFX Kit Voices.

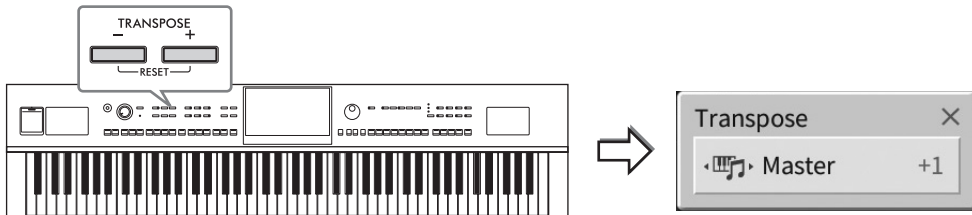

You can independently select the part to be transposed as desired. Touch the Transpose pop-up several times until the desired part appears, then use the TRANSPOSE [-]/[+] buttons to transpose it.

NOTE

Transpose can be done on the display also via [Menu] → [Transpose].

Master	Transposes the pitch of the entire sound with the exception of the Audio Song, the input sound from the [MIC/LINE IN] jack and the Audio Input Sound from the external device.
Keyboard	Transposes the keyboard pitch including the chord root for triggering Style playback.
Song	Transposes the pitch of the MIDI Song.

Fine tuning the pitch

By default, the pitch of the entire instrument is set to 440.0 Hz according to equal temperament. This setup can be changed from the display called up via [Menu] → [Tuning]. For details, refer to the Reference Manual on the website (page 9).

Hz (Hertz):

This unit of measurement refers to the frequency of a sound and represents the number of times a sound wave vibrates in a second.

Adjusting the Volume Balance

From the Balance display called up via [Menu] → [Balance], you can adjust the volume balance among the keyboard parts (Main, Layer, Left), the Style, the Song, the microphone sound, and the Audio Input Sound from the external device (page 107). Slide your finger vertically for each part to adjust the volume. Since the volume of MIDI Songs and Audio Songs are handled individually, you need to set the volume balance for each case (when a MIDI Song is selected, or when an Audio Song is selected).

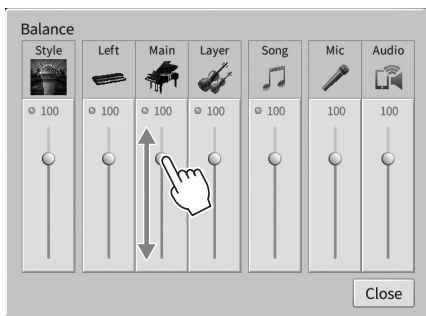

Restoring the Factory-programmed Settings (Initializing)

While holding the C7 key (right-most key on the keyboard), turn the power on. This restores (or initialize) all of the settings to their factory defaults, with the exception of “Language” (page 22), “Owner Name” (page 22) and Bluetooth pairing information (page 109).

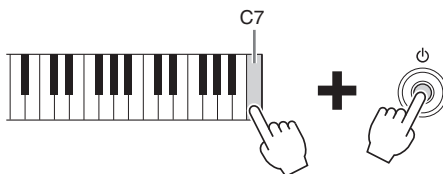

NOTE

You can also restore the factory default value of specified settings or delete all files/folders in the User memory on the display called up via [Menu] → [Utility] → [Factory Reset/Backup] → page 1/2. For details, refer to the Reference Manual on the website (page 9).

To restore the default value of any parameter you've changed

Touch and Hold the value on the display (page 30).

Data Backup

You can back up all data in the User memory of this instrument (except for Protected Songs) and all settings to the USB flash drive as a single file (file extension: .bup). This procedure is recommended for data security and backup in case of damage.

NOTE

- For information on the settings that can be backed up, refer to the “Backup/Restore” column of the “Parameter Chart” in the Data List on the website (page 9).
- Before using a USB flash drive, be sure to read “Connecting USB Devices” on page 103.
- You can back up User data such as Voice, Song, Style, Registration Memory and Playlist by copying them individually to USB flash drive. For instructions, refer to page 34.
- You can back up the System settings, MIDI settings and User Effect settings individually. For details, refer to the “Utility” section in the Reference Manual on the website (page 9).

- 1 Connect the USB flash drive to the [USB TO DEVICE] terminal as backup destination.**
- 2 Call up the display via [Menu] → [Utility] → [Factory Reset/ Backup] → page 2/2.**
If you want to back up the Audio Songs (WAV/MP3) saved to the User memory, enter a checkmark to the “Include Audio Files” box. Since audio files use large memory, remove the checkmark if you do not want to save them.

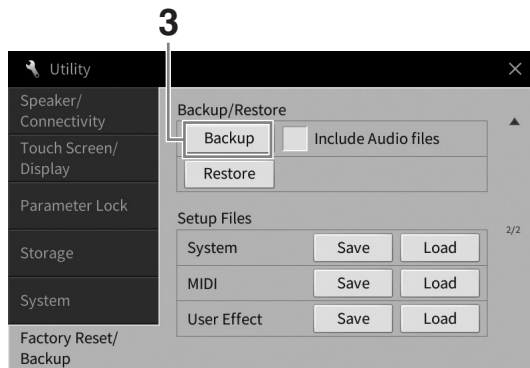

- 3 Touch [Backup] to save the backup file to the USB flash drive and follow the on-screen instructions.**

Restoring the Backup File

To do this, touch [Restore] in step 3 above. When the operation is complete, the instrument will be restarted automatically.

NOTICE

- If any of the files (such as Songs or Styles) in the User memory of the instrument have the same name with the data contained in the backup file, the data are overwritten by restoring the backup file. Move or copy the files in the User memory of the instrument to USB flash drive before restoring (page 34).
- Completing the backup/restore operation may take a few minutes. Do not turn off the power during backup or restoring. If you turn off the power during backup or restoring, data may be lost or damaged.

2 Piano Room

– Enjoying the Piano Performance –

The Piano Room function is for those who want to simply, conveniently, and fully enjoy playing the instrument as a piano. No matter what settings you've made from the panel, you can instantly call up the optimum settings for piano performance with a single button press. You can also change the piano settings as you like, or you can enjoy playing the piano as if you are in a small ensemble.

Playing a Piano Performance in the Piano Room

1 Press the [PIANO ROOM] button to call up the Piano Room display.

This calls up the relevant panel settings for piano performance. All buttons on the control panel with the exception of the [PIANO ROOM] and [HOME] buttons are disabled.

Accompaniment (page 45)

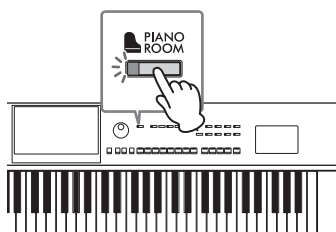

Recording/playback (page 48)

Detailed settings (page 47)

2 Play the keyboard.

Change the piano settings, such as Piano Type, Environment (Reverb Type), etc., according to the type of music you want to play.

■ Selecting a Piano Type

Touch the picture of the piano to call up the piano list, and then select the desired one. When a grand piano Voice is selected, you can open or close the lid by sliding up or down on the lid or by rotating the Data dial.

■ Selecting an Environment (Reverb Type)

Touch the background picture of the piano to call up the environment list, and then select the desired one. This sets the Reverb Type for the selected Environment.

■ Using the Metronome



Touch  (Metronome) to call up the pop-up display. You can turn the metronome on or off, or change its tempo. You can also change the tempo by tapping [Tap] in the pop-up display twice at the desired tempo.

To close a list or a setting display, touch anywhere outside of the list or setting display.

3 Press the [PIANO ROOM] button or [HOME] button to exit the Piano Room display.

All panel settings are restored to those which were set before the Piano Room display was called up.

Playing the Piano in Session with Other Instruments

- 1 Press the [PIANO ROOM] button to call up the Piano Room display.
- 2 Touch  (Accompaniment) at the upper right of the display. Session players appear in the display. Session players can be shown or hidden by touching  (Accompaniment) or  (Piano).

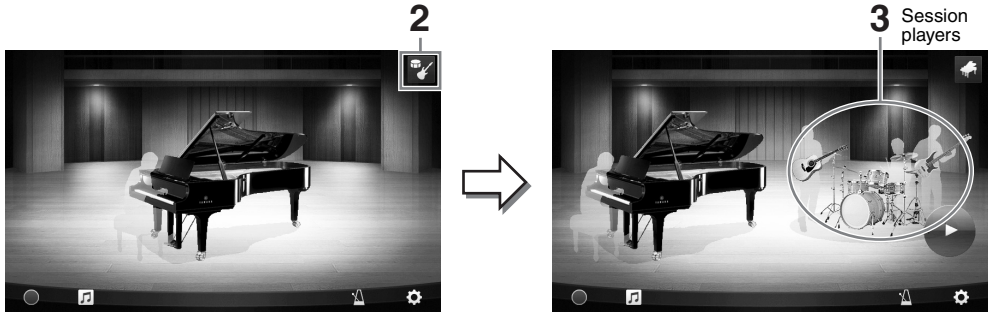





- 3 Select the type of accompaniment. Touch the picture of the session players to call up the list for selecting the desired accompaniment. To close the list, touch anywhere outside of the list.

Accompaniment Type

To scroll through pages of the list, slide it horizontally.



Accompaniment tempo

- 4 Touch  (Start). The Intro starts playing back. If you want to adjust the tempo, touch [] or [] in the display called up in step 3. Tapping [Tap] twice at the desired tempo can also change the tempo.
- 5 Play the keyboard following the Intro. The Session players provide accompaniment for your performance. Jazz or Pop is recommended.
- 6 Touch  (Stop) to stop the accompaniment. Accompaniment stops after an ending part is played.

NOTE

The function of accompaniment is available outside the Piano Room. For details, refer to page 58.

Changing the Accompaniment Settings

Touch  (Settings) at the bottom of the accompaniment type list of step 3 on page 45, to call up the setting display.

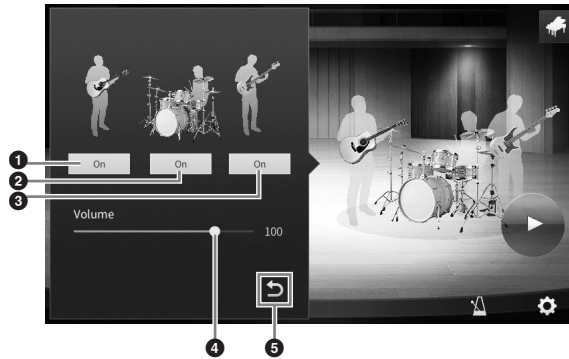

❶	Turns all parts, except those of rhythm and bass, on or off.
❷	Turns the rhythm parts and bass parts on or off.
❸	Turns the bass part on or off.
❹	Move the slider to adjust the volume of the accompaniment.
❺	Touch here to go back to the accompaniment type list.

Changing/Resetting the Piano Room Settings

You can change various Piano Room settings as you like. You can also restore all Piano Room settings to the default.

1 Press the [PIANO ROOM] button to call up the Piano Room display.

To change the settings of the accompaniment, touch  (Accompaniment) to call up the session players.



2 Touch  (Settings) to change the settings.

Shaded items in the list below are available only when session players are displayed. To close the setting display, touch anywhere outside of the setting display.

Environment*	For selecting the environment (Reverb Type).
Lid Position*	Determines how much the Lid is opened. Available only when a grand piano Voice is selected.
Tune	Determines the pitch of this instrument in 1 Hz steps.
Dynamics Control	Determines how the volume of the accompaniment responds to the strength with which you play the keys. Off The accompaniment volume does not respond to your playing strength. Narrow The accompaniment volume changes over a narrow range in response to your playing strength. In other words, you must play very strongly or softly to have the volume change. Medium ... The accompaniment volume changes normally in response to your playing strength. Wide The accompaniment volume changes over a wide range in response to your playing strength. In other words, playing strongly or softly produces greater changes in the volume.
Section Control*	Turning this on calls up buttons for changing variations (Sections) of accompaniment (A, B, C, D) in the display. By using these sections effectively, you can easily add variations to your performance.
Fingering Type*	Set the Fingering type (page 65) to “AI Full Keyboard” or “AI Fingered.”
Split Point*	Set the Style Split Point (page 54) when the “AI Fingered” is selected in Fingering Type above.
Reset	Restores all settings of Piano Room to the default.

The settings marked with * (asterisk) will be maintained even if you exit from this display or turn off the power. Pressing the [PIANO ROOM] button next time will call up the Piano Room settings which were made the previous time.

Recording your Performance in the Piano Room

You can record your performance in Piano Room as a MIDI Song (page 67) to the User memory of the instrument.

- 1 Press the [PIANO ROOM] button to call up the Piano Room display.**
Make any necessary settings, such as the type of piano, calling up the session players, and so on.
- 2 Touch [●] (Rec) to start recording, and then play the keyboard.**
If you want to record from the Intro section of the accompaniment, start the accompaniment.
- 3 Touch [■] (Stop) to stop recording.**
- 4 After a message appears prompting you to save, touch “Yes” to save the file.**

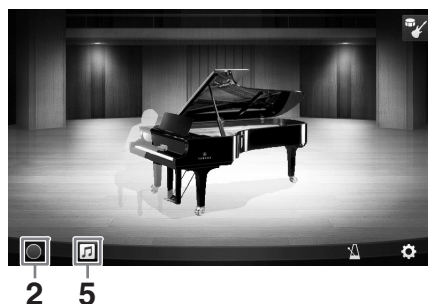

NOTICE

The recorded data will be lost if you turn the power off without executing the save operation.

- 5 To hear the recorded performance, touch [🎵] (Song), and then touch [▶] (Play) on the display that is called up.**
Touch [■] (Stop) to stop playback.

NOTE

The Songs recorded in the Piano Room are shown in the “PianoRoom” folder in the User tab (MIDI) on the Song Selection display (page 68).

Playing Back Recorded Songs, Changing Song Names, Deleting Songs

- 1 Touch [🎵] (Song) on the Piano Room display to call up the Song list.**
- 2 Touch the desired Song.**
- 3 Touch the desired icon.**

- ▶ (Play): Starts playback of the selected Song. To stop playback, touch [■] (Stop).
- 🔤 (Rename): Changes the name of the selected Song. For details on entering characters, refer to page 36.
- 🗑️ (Delete): Deletes the selected Song.

NOTE

The Songs recorded in the Piano Room can be selected and played back from the “PianoRoom” folder in the User tab (MIDI) on the Song Selection display (page 68).

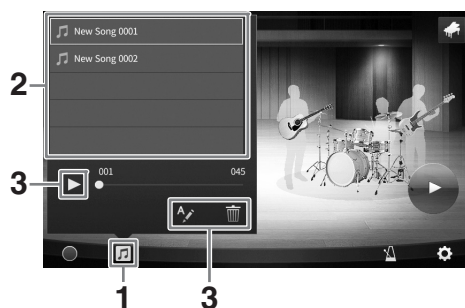

3 Voices

– Playing the Keyboard –

The instrument features a wide variety of exceptionally realistic instrumental Voices, including piano, guitar, strings, brass, wind instruments and more.

Playing Preset Voices

The Voices can be played via three keyboard parts: Main, Layer and Left. These playing modes allow you to play just one single Voice (Main), play two different Voices in layer (Main and Layer), or play different Voices in the right- and left-hand areas of the keyboard (Main/Layer and Left). By combining these three parts, you can create luscious instrument textures and convenient performance combinations.

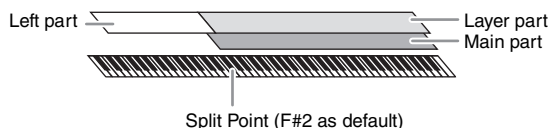

When the Left part is turned off, the entire keyboard is used for the Main and Layer parts. When the Left part is turned on, the F#2 and lower keys are used for the Left part while the upper keys (excluding F#2) are used for the Main and Layer parts. The key which divides the keyboard into the left-hand and right-hand areas is referred to as “Split Point” and its guide lamp lights when the Left part is turned on. The Voices of the parts which are turned on can be confirmed on the Home display.

NOTE

- You can also play only the Layer part by turning the Main part off.
- The Split Point can be changed (page 54).
- The guide lamp lights up also at the Style Split Point, when the STYLE CONTROL [ACMP ON/OFF] button is turned on.

1 Select the keyboard part then call up the Voice Selection display.

Do this to select a Voice for each keyboard part.

■ Touching the display

1-1 On the Home display, touch [Main], [Left], or [Layer] to turn on the desired keyboard part.

The center of the display shows the keyboard parts which are turned on and their corresponding Voices.



1-2 Touch the Voice of the desired part to call up the Voice Selection display.

■ Using the panel buttons

1-1 To select the keyboard part, press the VOICE [MAIN/LAYER/LEFT] button repeatedly if necessary until the desired part's lamp lights.

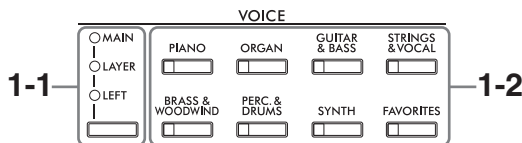

1-2 Press one of the desired VOICE category buttons to call up the Voice Selection display.

NOTE

- You can select Voices for the Main and Layer parts simply by using the Voice category selection buttons. While holding down one of the Voice category selection buttons, press another Voice category selection button. The Voice corresponding to the first pressed button is assigned to the Main part while the Voice of the second pressed button is assigned to the Layer part.
- You can change the sub category by pressing the same Voice category button twice or more.

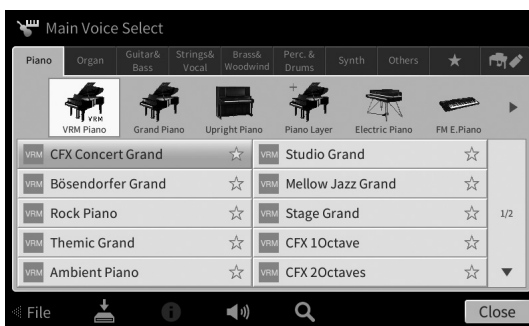

2 Touch the desired Voice.



NOTE

The "Others" tab contains XG Voices and so on. For details about how to select those Voices, refer to the "VoiceSetting" section in the Reference Manual on the website (page 9).

To hear the characteristics of the Voices:

Touch  (Demo) to start demo playback of the selected Voice. Touch  (Demo) again to stop playback.

Touch  (Information) to call up the Voice Information window, which may or may not be available depending on the Voice.

3 Make sure that the desired keyboard part is turned on.

The on/off setting for the keyboard part can be made as described in step 1-1 in "Touching the display."

4 Play the keyboard.

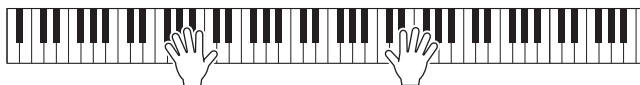

Voice Characteristics

At the left side of each Voice name on the Voice Selection display, the icon which represents its defining characteristic is indicated.

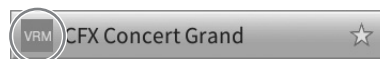

There are various Voice characteristics; however, only the following ones are covered here. For detailed explanations, refer to the “VoiceSetting” section in the Reference Manual on the website (page 9).

- **VRM : VRM Voices (page 53)**

These recreate the characteristic string resonance of a real acoustic piano.

- **S.Art / S.Art2 : Super Articulation (S.Art, S.Art2) Voices (page 55)**

The word “articulation” in music usually refers to the transition or continuity between notes. This is often reflected in specific performance techniques, such as staccato, legato and slur.

- **Organ Flutes : Organ Flutes Voices (page 56)**

Lets you recreate all of the classic organ sounds by adjusting the flute footage levels and the percussive sounds, just like on conventional organs.

- **Drum / Live Drum / Band Drum : Drum Voices, SFX / Live SFX / Band SFX : SFX Voices**

Lets you play various drums and percussion instruments or SFX (sound effects) sounds which are assigned to each key. For details on the Key assignments, refer to the “Drum/Key Assignment List” in the Data List on the website (page 9). On some Drum and SFX Voices, you can use the Drum Kit Tutor function to see the Key assignment on the display as described below.

Displaying the Instruments Assigned to the Keyboard (Drum Kit Tutor)

For Drums Voices in which  (Drum Kit Tutor) is appeared on the Voice area of the Home display or below the Voice Selection display, you can call up the key assignment by touching the icon.

1 Touch  (Drum Kit Tutor) to call up the Drum Kit Tutor window.

2 Press the desired key to check the key assignment.

The illustration and the name of the instrument assigned to the key appear on the Drum Kit Tutor window. Touch [◀]/[▶] to shift the illustration and instrument names by octaves (or press the desired key outside the displayed range).

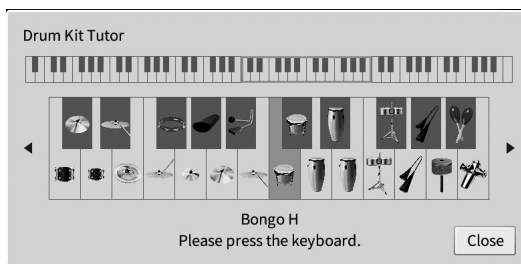
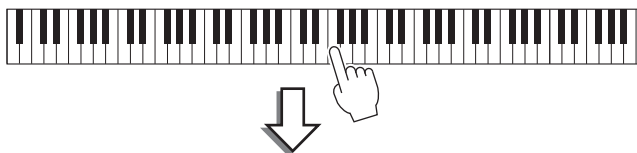

Maintaining the Left Voice even when releasing the keys (Left Hold)

When the Left Hold function is set to “On” via [Menu] → [Keyboard], the Voice for the Left part is held even when the keys are released. Non-decaying Voices such as strings are held continuously, while decay-type Voices such as piano decay more slowly (as if the sustain pedal has been pressed).

When the Left Hold is “On,” an “H” indication appears at the left side of the keyboard illustration in the center of the Home display.



Calling up the Appropriate Settings for Piano Performance (Piano Reset)

You can easily reset to appropriate settings for playing the instrument as a piano, no matter what settings you’ve made from the panel. This function called “Piano Reset” allows you to play the “CFX Concert Grand” Voice across the entire keyboard.

NOTE

This function cannot be used while the Piano Room display (page 44) or the Piano Lock display (see below) is shown.

- 1 Press and hold down the [PIANO ROOM] button for two seconds or longer.**
A message appears in the display.
- 2 Touch [Reset] to call up the appropriate settings for playing as a piano.**

Locking the Settings for Piano Performance (Piano Lock)

You can “lock” the panel settings to the appropriate settings for playing the instrument as a piano instantly, no matter what settings you’ve made from the panel. Once locked, the instrument stays in the default piano settings, even if other buttons are pressed — only allowing you to play the keyboard, use the pedals, or adjust the master volume. In other words, Piano Lock prevents you from accidentally selecting and playing another sound during your piano performance.

- 1 Press and hold down the [PIANO ROOM] button for two seconds or longer.**
A message appears in the display.
- 2 Touch [Lock] to call up the Piano Lock display.**
The panel settings will be locked in the appropriate settings for playing as a piano.

To disable Piano Lock, press and hold the [PIANO ROOM] button again for two seconds or longer.

If you turn off the power with Piano Lock enabled, turning on the power next time will call up the Piano Lock display.

Playing Realistic Resonance-enhanced Piano Sounds (VRM Voices)

Simply by selecting a VRM Voice, you can enjoy the VRM effect (see below). An icon [VRM] is shown at the left side of the Voice name of a VRM Voice on the Voice Selection display.

The default setting of the VRM effect is on. You can turn it on or off, and adjust the depth via [Menu] → [Voice Setting] → [Piano] → 1/2 page. For details, refer to the Reference Manual on the website (page 9).

VRM (Virtual Resonance Modeling)

On an actual acoustic piano, if you press the damper pedal and play a key, not only does the string of the pressed key vibrate, it also causes other strings and the soundboard to vibrate, with each influencing the rest, creating a rich and brilliant resonance that sustains and expands. The VRM (Virtual Resonance Modeling) technology featured in this instrument reproduces the complicated interaction between both string and soundboard resonance, and make the sound more like that of a real acoustic piano. Since resonance instantaneously occurs depending on the action of the keys and pedal, you can expressively vary the sound by changing the timing of your pressing the keys, and the timing and depth of your pressing the pedal.

Reproducing tonal variations that respond to subtle changes in touch (Grand Expression Modeling)

When the Voice of “CFX Concert Grand” or “Bösendorfer Grand” is selected, the Grand Expression Modeling effect is automatically added, and it faithfully reflects nuances of your playing touch to tonal variations, just as on a real grand piano.

Grand Expression Modeling

On an actual acoustic piano, subtle changes in the sound can be produced by changing your playing touch from when you press a key to when you release it. For example, when you press a key all the way to its bottom, the key hits the keybed underneath and the noise reaches the strings, changing the sound slightly. Furthermore, the tone when the damper is lowered onto strings to mute the sound is changed by how quickly you release the key. Grand Expression Modeling technology recreates these subtle changes in the sound that respond to your touch. This allows you to add accents by playing strongly or add resonance by playing softly to produce superbly expressive sound. A crisp tone can be heard when playing staccato as well as a lingering sound produced when releasing the keys slowly.

Setting the Split Point

The key which divides the keyboard into two or three areas is referred to as “Split Point.” There are two types of Split Point: “Left Split Point” and “Style Split Point.” The “Left Split Point” divides the keyboard into the Left part area and Main part area while the “Style Split Point” divides the keyboard into the Chord section for Style playback (page 59) and the Main or Left part area. Though both Split Points are at the same key (F#2) by default, you can also set them individually (as shown).

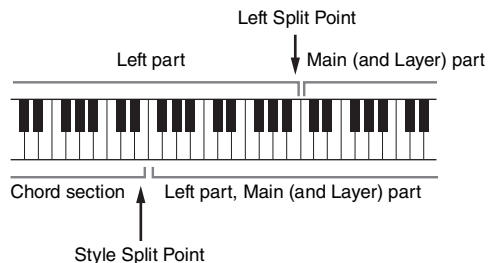

NOTE

The guide lamp located at the Split Point lights up when the Left part is turned on or the [ACMP ON/OFF] button is turned on.

1 Call up the Split Point/Fingering window: [Menu] → [Split&Fingering].

NOTE

The Split Point/Fingering window can be called up also by holding the keyboard illustration on the Home display.

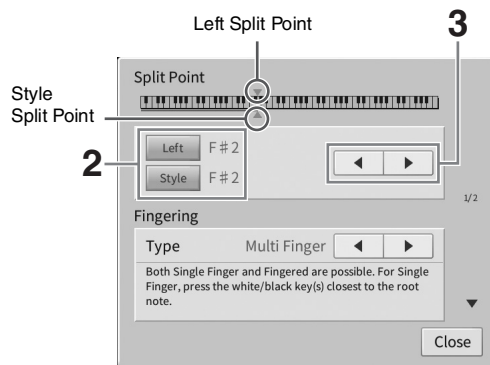

2 Touch [Left] or [Style] to turn it on.

If you want to set both Split Points to the same key, turn both of them on.

3 Touch [◀]/[▶] to select the desired key as Split Point.

You can set the Split Point also by pressing the actual key while holding down the keyboard illustration on the display.

NOTE

The Left Split Point cannot be set lower than the Style Split Point.

Playing Super Articulation Voices

The Super Articulation Voices (S.Art Voices and S.Art2 Voices) enable you to create subtle, very realistic musical expressions, simply by how you play. The [S.Art]/[S.Art2] icons are shown beside the Voice name of Super Articulation Voices (S.Art, S.Art2) on the Voice Selection display or the Home display. For specific performance instructions on certain Voices, you can call up the Information window of the selected S.Art Voice or S.Art2 Voice by touching this icon on the Home display.

■ S.Art Voices

The S.Art Voices provide many benefits with great playability and expressive control in real time.

• Example: Saxophone Voice

If you play a C note and then an adjacent D in a very legato way, you will hear the note change seamlessly, as though a saxophone player played it in a single breath.



• Example: Guitar Voice

If you play a C note and then the E just above in a very legato but firm way, the pitch slides up from C to E.

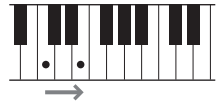

■ S.Art2 Voices (CVP-909 only)

For wind instrument Voices and string instrument Voices, a special technology called AEM has been used, which features detailed samples of special expressive techniques used on those specific instruments — to bend or slide into notes, to “join” different notes together, or to add expressive nuances at the end of a note, etc.

NOTE

AEM is a technology that simulates the sound of acoustic instruments naturally by smoothly joining the most appropriate sound samples selected from the data base in realtime during performance.

• Example: Clarinet Voice

If you hold a C note and play the B^b above, you'll hear a glissando up to the B^b.



Adding Articulation Effects by Using the Pedal

When you assign an S.Art or S.Art2 Voice to the Main part, the function of the center or/and left pedals are switched to control articulation effects. Pressing a pedal triggers different playing effects, separate from your keyboard playing. For example, pressing a pedal for a saxophone Voice can produce breath noises or key noises, while doing the same for a guitar Voice can produce fret noises or body-tapping sounds. You can effectively intersperse these into the notes as you play.

When an S.Art2 Voice is selected, pressing a pedal and playing/releasing a note enables you to add articulation effects, such as bend up/down, glissando up/down, brass falls, etc.

NOTE

- For some Super Articulation Voices, articulation effects are not assigned to pedals.
- If you want to lock the pedal function regardless of the Voice, turn off the Switch With Main Voice parameter called up via [Menu] → [Assignable] → [Pedal] → [Switch With Main Voice (Center & Left)].
- If you assign the Articulation function to the ASSIGNABLE buttons (page 31), you can control articulation effects by using the buttons instead of the pedals.

NOTE

- S.Art and S.Art2 Voices are only compatible with other models which have those types of Voices installed. Any Song or Style data you've created on the instrument using these Voices will not sound properly when played back on other instruments.
- S.Art and S.Art2 Voices sound differently depending on the keyboard range, velocity, touch, etc. Hence, if you turn on a Keyboard Harmony effect, change the transpose setting or change the Voice Settings, unexpected or undesired sounds may result.
- The characteristics of S.Art2 Voices (default vibrato setting and articulation effects applied by the pedals) are effective for real-time performance; however, these effects may not be completely reproduced when you play back a Song which has been recorded using S.Art2 Voices.

Creating Original Organ Flutes Voices

The instrument uses advanced digital technology to recreate the legendary sound of vintage organs. Just as on a traditional organ, you can create your own sound by increasing and decreasing the levels of the flute footages. The created Voice can be saved for future recall.

NOTE

The term “footage” is a reference to the sound generation of traditional pipe organs, in which the sound is produced by pipes of different lengths (in feet).

There are three organ types, and each organ type has its own display, which beautifully recreates the actual appearance of an actual instrument. Each type provides realistic, intuitive control over the sound with special footage levers, tabs and switches—letting you adjust the sound with much the same feel as on an actual instrument.



- **Vintage:** Simulating the iconic sound of an American vintage jazz and rock organ.
- **Euro:** A well known European Pops organ with the iconic rotary sound captured in the sample.
- **Home:** A traditional American tabs organ of the 70s and 80s suited for middle-of-the road standards.

- 1 On the Voice Selection display, select the desired Organ Flutes Voice.**
Touch the [Organ Flutes] tab in the [Organ] category, and then select the desired Organ Voice.
- 2 Return to the Home display, and then touch  (Organ Flutes) located at the upper right of the Voice name to call up the Organ Flutes Voice Edit display.**
- 3 Slide the Footage levers to adjust the footage settings.**
The footage settings determine the basic sound of the Organ Flutes.

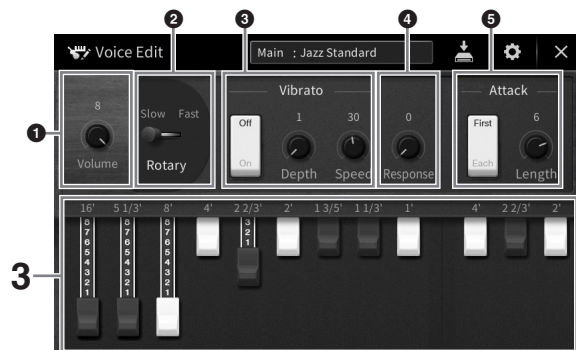

If you want, you can change the settings such as Rotary Speaker and Vibrato.

❶	Volume	Determines the volume of the entire Organ Flutes sound.
❷	Rotary/ Tremolo*	Alternately switches the Rotary Speaker speed between “Slow” and “Fast.” This parameter is available only when an effect type which contains “Rotary” in its name is applied.
❸	Vibrato*	Turns the vibrato on or off, and allows you to adjust the vibrato depth and vibrato speed.
❹	Response	Adjusts the response speed of both the Attack and Release portions of the sound.
❺	Attack	Switches between two different Attack modes: First and Each, and determines the length of the Attack sound.

The parameters indicated by “*” are available only for the Vintage and Home type.

NOTE

You can also make Effects and EQ (equalizer) settings. For details, refer to the “VoiceEdit” section in the Reference Manual on the website (page 9).

4 Touch (Save) and save the created Organ Voice.

For instructions on saving, refer to page 32.

NOTICE

The settings will be lost if you select another Voice or turn the power to the instrument off without executing the Save operation.

NOTE

In addition to the Organ Flutes Voices, other Voices can be edited by calling up the Voice Edit display from the Menu after selecting the desired Voice. For details, refer to the Reference Manual on the website (page 9).

4 Styles

– Playing Rhythm and Accompaniment –

The instrument features a variety of accompaniment and rhythmic backing patterns (called “Styles”) in a variety of different musical genres including pop, jazz, and many others. Each Style features Auto Accompaniment, letting you produce automatic accompaniment playback simply by playing “chords” with your left hand. This lets you automatically recreate the sound of a full band or orchestra — even if you’re playing by yourself.

Playing with a Style

Try out Style accompaniment with the following song. After you understand how to use the Style, try out other songs by using various Styles.

Mary Had a Little Lamb (Style: Country 8Beat 2)

The musical score for "Mary Had a Little Lamb" is presented in two systems. The first system consists of four measures with chords C, C, G, and C. The second system consists of five measures with chords C, C, F, G, and C, followed by an "Ending" section. The notation includes a treble clef with a key signature of one sharp (F#) and a common time signature (C). The bass line consists of simple chords and single notes. Piano keyboard diagrams are provided for each measure to show the chord voicings.

NOTE

The Fingering type (page 65) of “Multi Finger” (default setting) or “Single Finger” can be used for the example score here; the instructions hereafter assume one or the other is used.

- 1 On the Home display, touch the Style name to call up the Style Selection display.

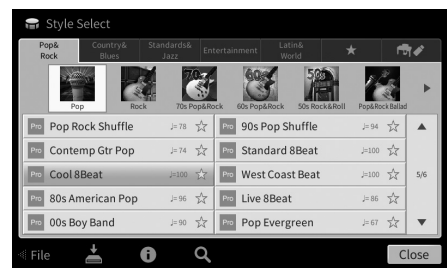

2 Touch the desired Style.

For the example score above, touch [Country & Blues] category and touch [Modern Country], and then touch [Country 8Beat 2].

The Style category can be selected also by pressing one of the STYLE buttons.

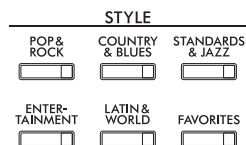

NOTE

You can change the sub category by pressing the same Style category button twice or more.

3 Make sure that the STYLE CONTROL [ACMP ON/OFF] button is turned on.

When turned on, the specific left-hand section of the keyboard can be used as the Chord section, and chords played in this section are automatically detected and used as a basis for fully automatic accompaniment with the selected Style.

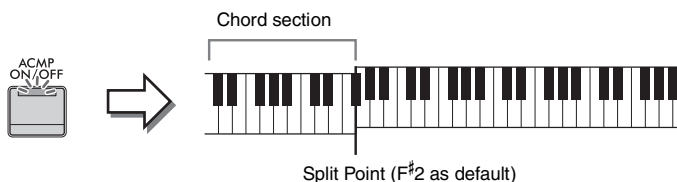

NOTE

- The Split Point can be changed as desired (page 54).
- By default, the chord section (Chord Detection Area) is set to the left-hand section, but you can change it to the right-hand section (page 66) if desired.
- When the [ACMP ON/OFF] button is off, only the rhythm part is played back (auto accompaniment is not played back).

4 Return to the Home display, touch [◀] at the upper left to expand the Style area, and then touch [≡] (SYNC START) to enable Sync Start.



Here and in the later steps, the operation in the Style area of the Home display can be controlled by the STYLE CONTROL buttons (page 60).

5 Play a chord with your left hand to start the selected Style.

Referring to the notation on page 58, play chords with your left hand and a melody with your right.

6 Touch [▶/■] (START/STOP) to stop Style playback.

You can also stop playback by pressing one of the ENDING/rit. [I] – [III] buttons at the “Ending” location on the notation (page 61).

Style Characteristics

The Style type and its defining characteristics are indicated on the Preset Style icon (such as Pro and Session). For details about these icons, refer to the “StyleSetting” section in the Reference Manual on the website (page 9).



A Style generally consists of eight parts (channels): rhythm, bass, etc. You can add variations and change the feeling of a Style by selectively turning channels on/off or by changing the Voices (page 100).

Style File Compatibility

This instrument uses the SFF GE file format (page 8) and can play back existing SFF files; however, they will be saved in the SFF GE format when the file is saved (or loaded) in this instrument. Please keep in mind that the saved file can only be played back on instruments that are compatible with the SFF GE format.

Style Control Operations

To do this, use the on-screen buttons called up by touching [◀] in the Style area of the Home display, or use the STYLE CONTROL buttons.

NOTE

For instructions on adjusting the tempo, refer to page 39.

Home display

While Style is stopped

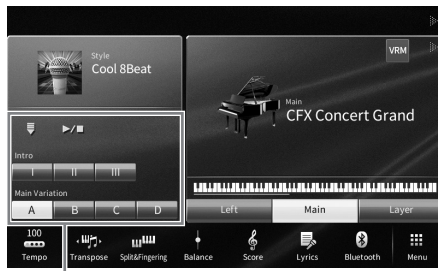

Style Control

While Style is playing



Style Control

STYLE CONTROL buttons



[ACMP ON/OFF], [AUTO FILL IN] and [SYNC STOP] can be controlled only by using the panel buttons.

To Start/Stop Playing

■ [▶/■] (START/STOP)

Starts playback of the rhythm part of the current Style. To stop playback, press this button again.



Playing back both rhythm and auto accompaniment ([ACMP ON/OFF] button)

If you turn on the [ACMP ON/OFF] button, both the rhythm part and auto accompaniment can be played back when playing chords in the chord section during Style playback.



NOTE

- The rhythm does not sound for some Styles. When you want to use any of these Styles, always make sure that [ACMP ON/OFF] button is turned on.
- By default, [ACMP ON/OFF] is turned on when you turn the power on. You can set whether the [ACMP ON/OFF] button is on or off when the power is turned on via [Menu] → [StyleSetting] → [Setting] → [ACMP On/Off default].

■ [≡] (SYNC START)

This puts the Style playback in standby. The Style starts playing back when you play a chord with your left hand (when [ACMP ON/OFF] is on) or you press any note on the keyboard (when [ACMP ON/OFF] is off). During Style playback, pressing this button stops the Style and puts playback in standby.

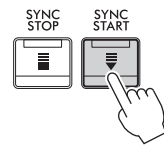

■ [SYNC STOP] button

You can start and stop the Style anytime you want by simply playing or releasing the keys in the chord section of the keyboard. Make sure that the [ACMP ON/OFF] button is on, press the [SYNC STOP] button, and then play the keyboard.

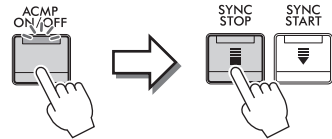

NOTE

When the Fingering type (page 65) is set to "Full Keyboard" or "AI Full Keyboard," Sync Stop cannot be turned on.

■ INTRO [I] – [III]

The instrument features three different Intro sections to add an introduction before starting Style playback. After pressing (or touching) one of the INTRO [I] – [III] buttons, start playback of the Style. When the Intro finishes playing, Style playback automatically shifts to the Main section.



NOTE

When you select INTRO [II] or [III], you need to play chords in the chord section to play the complete Intro section.

■ ENDING/rit. [I] – [III]

The instrument features three different Ending sections to add an ending before stopping Style playback. When you press (or touch) one of the ENDING/rit. [I] – [III] buttons while a Style is playing back, the Style will automatically stop after the ending is played. You can have the ending gradually slow down (ritardando) by pressing the same ENDING/rit. button once again, while the ending is playing.



NOTE

If you press the ENDING/rit. [I] button when the Style is playing, a fill-in automatically plays before ENDING/rit. [I].

Changing Variation (Sections) During Style Playback

Each Style features four different Main sections, four Fill-in sections and a Break section. By using these sections effectively, you can easily make your performance sound more dynamic and professional. The section can be freely changed while the Style is playing back.

■ MAIN VARIATION [A] – [D]

Press (or touch) one of the MAIN VARIATION [A] – [D] to select the desired Main section (the button lights in red). Each is an accompaniment pattern of a few measures and it plays indefinitely. Pressing the selected MAIN VARIATION button again maintains the same section, but plays an appropriate fill-in pattern to spice up the rhythm and break the repetition.

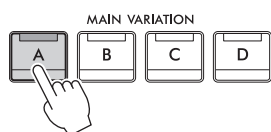

Press the selected Main section (lit in white) again.

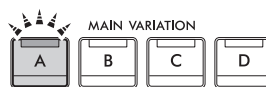

The fill-in of the selected Main section plays (flashes in white).

Adding a Fill-in when changing the Main section ([AUTO FILL IN] button)

When the [AUTO FILL IN] button is turned on, pressing any of the Main [A] – [D] buttons as you play automatically plays a fill-in section.

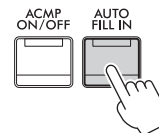

■ [BREAK] (BREAK)

This lets you add dynamic breaks in the rhythm of the accompaniment. Press this button during Style playback. When the one-measure Break pattern finishes playing, the Style playback automatically shifts to the Main section.



About the lamp status of the section buttons (INTRO/MAIN VARIATION/BREAK/ENDING)

- **White:** The section is currently selected.
- **White (flashing):** The section will be played next, following the currently selected section.
 - * The Main [A] – [D] button lamps also flash in white.
- **Blue:** The section contains data but is not currently selected.
- **Off:** The section contains no data and cannot be played.

Playing Styles Automatically with Custom Chord Progressions (Chord Looper)

Normally, while playing along with a Style, you play chords in the chord section of the keyboard. However, by using the Chord Looper function, you can record chord progressions you want to play over, and the Style can be played back in a loop responding to the chord progression data. For example, if you play the chords C, F, G and C in order and record it, the Style loops and keeps playing back as “C / F / G / C → C / F / G / C ...” —without the need for you to play chords in the chord section of the keyboard. This extends your performance capability, letting you play freely with both your left and right hands. For details, refer to the “ChordLooper” section in the Reference Manual on the website (page 9).

Calling up Panel Settings Appropriate for the Current Style (One Touch Setting)

One Touch Setting is a powerful and convenient feature that automatically calls up the most appropriate panel settings (Voices or effects, etc.) for the currently selected Style, with the touch of a single button. If you've already decided which Style you wish to use, you can have One Touch Setting automatically select the appropriate Voice for you.

1 Select the desired Style (steps 1– 2 on page 58).

2 Press one of the ONE TOUCH SETTING [1] – [4] buttons.

Not only does this instantly call up all the settings (Voices, effects, etc.) that match the current Style, it also automatically turns on ACMP and SYNC START, so that you can immediately start playing the Style.



Confirming the One Touch Setting Contents

In the Style Selection display, touch  (Information) to call up the Information window that shows what Voices are assigned to the ONE TOUCH SETTING [1] – [4] buttons for the current Style. You can call up the desired settings also by touching one of the One Touch Settings 1– 4 directly on the Information window.

NOTE

Gray color for a Voice name indicates that the corresponding Voice part is currently turned off.

3 As soon as you play a chord with your left hand, the selected Style starts.

Each Style has four One Touch Setting setups. Press the other ONE TOUCH SETTING [1] – [4] buttons to try out other setups.

Automatically Changing One Touch Settings with the Main Sections

The convenient OTS (One Touch Setting) Link function lets you automatically have One Touch Settings change when you select a different Main section (A – D). The Main sections A, B, C and D correspond to One Touch Settings 1, 2, 3 and 4 respectively. To use the OTS Link function, turn the [OTS LINK] button on.



NOTE

You can change the timing in which the One Touch Settings change with MAIN VARIATION [A] – [D] changes. To do this, touch [Menu] → [StyleSetting] → [Setting] then set the OTS Link Timing parameter. For details, refer to the Reference Manual on the website (page 9).

Memorizing original settings to One Touch Setting

You can memorize your original panel settings to the One Touch Setting. The newly created One Touch Setting will be saved in the User tab as a User Style, and you can call up the One Touch Setting as a part of the Style file.

- 1 Select the desired Style to memorize your One Touch Setting.**
- 2 Make the desired panel settings, such as those for Voices and Effects.**
- 3 Press the [MEMORY] button of REGISTRATION MEMORY.**

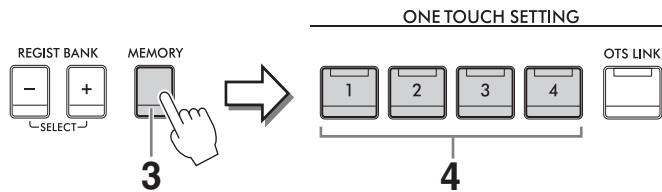

- 4 Press one of the ONE TOUCH SETTING [1] – [4] buttons.**
A message appears prompting you to save the panel settings.
- 5 Touch [Yes] to call up the Style Selection display for saving your data, and then save the current settings as a User Style.**
For instructions on saving, refer to page 32.

NOTE

To cancel this operation, touch [No].

NOTICE

The memorized One Touch Setting will be lost if you change to another Style or you turn the power off without executing the save operation.

Changing the Chord Fingering Type

You can change the Chord Fingering type depending on your playing style.



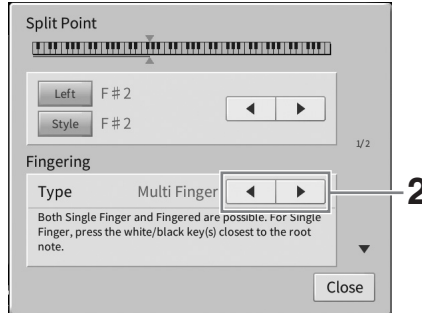

1 Call up the Split Point/Fingering window: [Menu] → [Split&Fingering].

NOTE

The Split Point/Fingering window can be called up also by holding the keyboard illustration on the Home display.



2 Touch [◀]/[▶] to select the desired Fingering Type.

<p>Single Finger</p>	<p>Lets you easily play chords in the accompaniment range of the keyboard using only one, two or three fingers. This type is available only for Style playback.</p> <p>C  Major chord Press the root key only.</p> <p>Cm  Minor chord Simultaneously press the root key and a black key to its left.</p> <p>C7  Seventh chord Simultaneously press the root key and a white key to its left.</p> <p>Cm7  Minor seventh chord Simultaneously press the root key and both a white and black key to its left.</p>
<p>Multi Finger</p>	<p>Automatically detects Single Finger or Fingered chord fingerings, so you can use either type of fingering without having to switch fingering types.</p>
<p>Fingered</p>	<p>Lets you finger your own chords on the chord section of the keyboard, while the instrument supplies appropriately orchestrated rhythm, bass, and chord accompaniment in the selected Style. The Fingered type recognizes the various chord types which are listed on the “Split&Fingering” section in the Reference Manual on the website (page 9) and can be looked up using the Chord Tutor function called up via [Menu] → [ChordTutor].</p>
<p>Fingered On Bass</p>	<p>Accepts the same fingerings as Fingered, but the lowest note played in the Chord section of the keyboard is used as the bass note, allowing you to play “on bass” chords. (In the Fingered mode, the root of the chord is always used as the bass note.)</p>
<p>Full Keyboard</p>	<p>Detects chords in the entire key range. Chords are detected in a way similar to Fingered, even if you split the notes between your left and right hands — for example, playing a bass note with your left hand and a chord with your right, or by playing a chord with your left hand and a melody note with your right.</p>

AI Fingered	<p>Basically the same as Fingered, with the exception that less than three notes can be played to indicate the chords (based on the previously played chord, etc.).</p> <p>NOTE Only in the Piano Room, your performance in the Chord section produces the sound of the selected Voice as well as that of the accompaniment.</p>
AI Full Keyboard	<p>When this advanced fingering type is engaged, the instrument will automatically create appropriate accompaniment while you play just about anything, anywhere on the keyboard using both hands. You don't have to worry about specifying the Style chords. Although the AI Full Keyboard type is designed to work with many songs, some arrangements may not be suitable for use with this feature. This type is similar to Full Keyboard, with the exception that less than three notes can be played to indicate the chords (based on the previously played chord, etc.). 9th, 11th and 13th chords cannot be played. This type is available only for Style playback.</p>

NOTE

When the Chord Detection Area is set to "Upper" (see below), only "Fingered*" is available. This type is basically same as "Fingered," except that "1+5," "1+8" and Chord Cancel are not available.

Specifying Chords with Your Right Hand for Style Playback (Changing the Chord Detection Area)

By changing the Chord Detection Area from the left-hand section ("Lower") to the right-hand section ("Upper"), you can play the bass line with your left hand while using your right hand to control Style playback. For details, refer to the "Split&Fingering" section in the Reference Manual on the website (page 9).

Chords

For users who are unfamiliar with chords, this handy chart features common chords for your quick reference. Since there are many useful chords and many different ways to use them musically, refer to commercially available chord books for further details.

★ Indicates the root note.

Major	Minor	Seventh	Minor Seventh	Major Seventh
C 	Cm 	C7 	Cm7 	CM7
D 	Dm 	D7 	Dm7 	DM7
E 	Em 	E7 	Em7 	EM7
F 	Fm 	F7 	Fm7 	FM7
G 	Gm 	G7 	Gm7 	GM7
A 	Am 	A7 	Am7 	AM7
B 	Bm 	B7 	Bm7 	BM7

5 Song Playback

– Playing and Practice Songs –

For the Clavinova, “Song” refers to MIDI or audio data which include preset songs, commercially available music files, etc. Not only can you play back a Song and listen to it, but you can also play the keyboard along with Song playback.

There are two kinds of Songs that can be recorded and played back on this instrument: MIDI Songs and Audio Songs.

• MIDI Song

A MIDI Song is comprised of your keyboard performance information and is not a recording of the actual sound itself. The performance information refers to which keys are played, at what timing, and at what strength — just as in a musical score. Based on the recorded performance information, the tone generator (of the Clavinova, etc.) outputs the corresponding sound. Since MIDI Song data contains the information such as keyboard part and Voice, you can practice effectively by viewing the score, turning the particular part on or off, or changing Voices.

• Audio Song

An Audio Song is a recording of the performed sound itself. This data is recorded in the same way as that used with voice recorders, etc. Audio data in WAV or MP3 format can be played back on this instrument just like playing it on your smartphone or portable music player, etc.

Availability of functions differs between MIDI Songs and Audio Songs. In this chapter, the following icons indicate whether or not the explanation applies to MIDI Songs or Audio Songs individually.

Example: **MIDI** **Audio** ... Indicates explanation applies only to MIDI Songs.

Playback of Songs

MIDI

Audio

You can play back the following types of Songs.

- Preset Songs (MIDI Songs)
- Your own recorded Songs (see page 76 for instructions on recording)
- Commercially available Songs: MIDI files in SMF (Standard MIDI File) format, Audio files in WAV or MP3 format.

WAV	44.1 kHz sample rate, 16 bit resolution, stereo
MP3	MPEG-1 Audio Layer-3: 44.1/48.0 kHz sample rate, 128 – 320 kbps and variable bit rate, mono/stereo

NOTE

For information on compatible MIDI formats, refer to page 8.

If you want to play back a Song in a USB flash drive, connect the USB flash drive containing Song data to the [USB TO DEVICE] terminal beforehand.

NOTE

Before using a USB flash drive, be sure to read “Connecting USB Devices” on page 103.

- 1 On the Home display, touch the Song name to call up the Song Selection display.

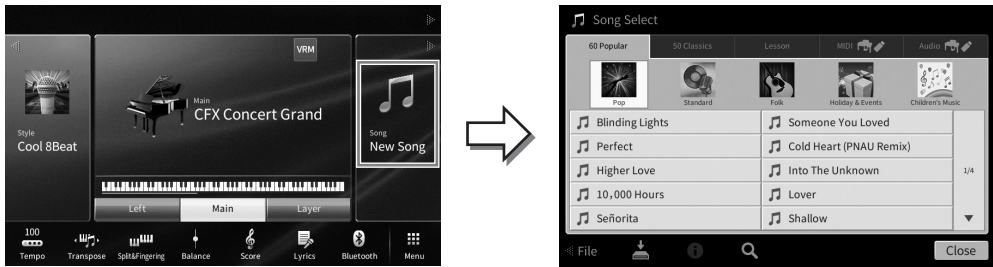

- 2 Touch the desired Song on the display to select it.

A Preset Song can be selected from one of the following tabs:

- **60 Popular:** Various popular Songs divided into several categories
- **50 Classics:** Various classical Songs included in the “50 Classical Music Masterpieces” (Music book)
- **Lesson:** Various Songs suitable for piano practice

The Songs you recorded or the commercially available songs can be selected from one of the following tabs:

- **MIDI** : Calls up a list of the MIDI Songs
- **Audio** : Calls up a list of the Audio Songs

NOTE

- The “PianoRoom” folder in the User tab (MIDI) contains the Songs recorded in the Piano Room (page 48).
- On the Song Selection display or the Home display, you can distinguish the data format of the Audio Song by the icon shown next to the Song name. If it is in MP3 format, “MP3” appears in the icon, and in case of WAV format, nothing is shown.

Viewing Audio Song information

When an Audio Song is selected, touching (Information) on the Song Selection display calls up the Song Information window which shows the Song title, artist name, etc.

- 3 Return to the Home display, touch at the upper right to expand the Song area, and then touch (Play/Pause) to start playback.



Here and in the later steps, the operation in the Song area of the Home display can be controlled by the SONG CONTROL buttons (page 69).

Queuing the next Song for playback (MIDI Song only)

While a MIDI Song is playing back, you can queue up the next MIDI Song for playback. This is convenient for chaining it to the next Song smoothly during stage performance. Select the Song you want to play next in the Song Selection display, while a Song is playing back. The [Next] icon appears at the right side of the corresponding Song name. To cancel this setting, touch the [Next] icon.

4 Touch [■] (Stop) to stop playback.

Song Control Operations

To control Song playback, you can use the on-screen buttons called up by touching [▶] in the Song area of the Home display, or use the SONG CONTROL buttons on the panel.

Home display

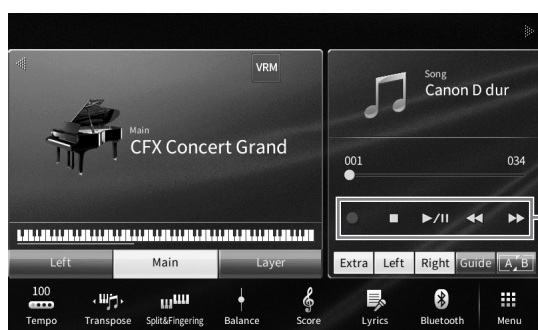

SONG CONTROL buttons



Keep in mind that, unlike with certain panel button operations, you cannot touch two buttons simultaneously on the display.

NOTE

- For instructions on adjusting the tempo, refer to page 39 for MIDI Songs, and page 75 for Audio Songs.
- For information about [●] (Rec), refer to page 76.

■ Pause

Press (or touch) [▶/||] (Play/Pause) during playback. Pressing it again resumes Song playback from the current position.

■ Rewind/Fast Forward

Press (or touch) [◀◀] (Rewind) or [▶▶] (Fast forward) during playback or while the Song stopped. Pressing one of them once moves one measure back/forward for MIDI Songs, or one second for Audio Songs. Holding one of them scrolls backward/forward continuously.

When you press (or touch) [◀◀] (Rewind) or [▶▶] (Fast forward), a setting display appears showing the current position of the Song.

For MIDI Songs

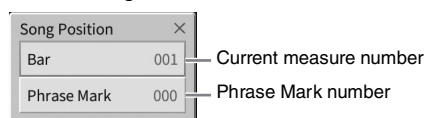

For Audio Songs

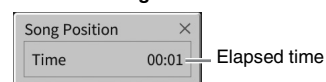

The Phrase Mark number appears only when a MIDI Song containing Phrase Marks is selected. You can choose to rewind/fast forward the Song in “Bar” or “Phrase Mark” units by touching the setting display beforehand.

NOTE

- The pop-up window mentioned here does not appear when you rewind or fast forward a MIDI Song not having Phrase Marks or an Audio Song by touching on the display.
- Phrase Mark is a pre-programmed marker in certain MIDI Song data, which specifies a specific location in the Song.

Moving the Song Playback Position

In the Song area (when expanded) of the Home display, the current position of the Song playback is shown. This can be moved forward or backward by moving the slider on the display.

When a MIDI Song is selected:

Current measure number Last measure number

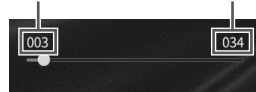

When an Audio Song is selected:

Elapsed time Total time

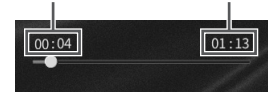

■ Synchro Start (MIDI Song)

You can conveniently start playback of a MIDI Song as soon as you start playing the keyboard. While playback is stopped, hold down the SONG CONTROL [■] (Stop) button and press the [▶/||] (Play/Pause) button. To cancel the Synchro Start function, repeat the same operation.

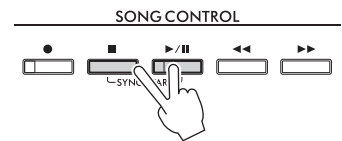

NOTE

You can also enable the Synchro Start function by holding [▶/||] (Play/Pause) in the Song area (when expanded) of the Home display.

Displaying Music Notation (Score)

MIDI

Audio

You can view the music notation (score) of the selected Song. We suggest that you read through the music notation before starting to practice.

1 Select a MIDI Song (steps 1 – 2 on page 68).

2 Call up the Score display via [Menu] → [Score].

You can look through the entire notation by touching [◀] or [▶] when the Song playback is stopped. As starting playback, the “ball” bounces along through the score, indicating the current position.



For changing the page.

For changing the settings of the Score display.

NOTE

- The instrument can generate and display music notation for MIDI Songs, such as preset Songs, commercially available music data, and even your recorded performances.
- The displayed notation is generated by the instrument based on the Song data. As a result, it may not be exactly the same as commercially available sheet music of the same song — especially when displaying notation of complicated passages or many short notes.

Changing the Size of the Score/Displaying Lyrics in a Score

By touching  (View Settings) shown on the lower right of the display, you can change the settings of the Score display, such as changing the size of the score, or displaying note names or lyrics within the score, and so on. For details on the Score display, refer to the Reference Manual on the website (page 9).

NOTE

Lyrics can be shown only when the MIDI Song contains lyric data.

Displaying Lyrics

MIDI

Audio

When the selected Song contains lyric data (for Audio Songs, only those of MP3 format are compatible), you can view it on the instrument's display during playback.

- 1 Select a Song (steps 1 – 2 on page 68).
- 2 Call up the Lyrics display via [Menu] → [Lyrics].

When the Song data contains lyrics data, the lyrics are shown on the display. You can look through the entire lyrics by touching [◀] or [▶] when Song playback is stopped. As Song playback starts, the color of the lyrics changes, indicating the current position.



For changing the page.

NOTE

The Lyrics can be displayed on an external monitor or television (page 111).

For details on the Lyrics display, refer to the Reference Manual on the website (page 9).

Displaying Text

Regardless of whether a Song is selected or not, you can view the text file (.txt) created by using a computer on the instrument's display ([Menu] → [TextViewer]). This feature enables various useful possibilities, such as the showing of lyrics, chord names, and text notes. For details on the Text display, refer to the Reference Manual on the website (page 9).

One-handed Practice with the Guide Function

MIDI

Audio

You can mute the right-hand part to try practicing that part on your own. The explanations here apply when you practice the right-hand part with “Follow Lights” of the Guide functions. The guide lamps indicate the notes you should play and when you should play them. You can also practice at your own pace — since the accompaniment waits for you to play the notes correctly.

NOTE

When the [ACMP ON/OFF] button is turned on, the guide lamps for the left-hand part do not work. As necessary, turn off the [ACMP ON/OFF] button when using it.

- 1 Select a MIDI Song and call up the Score display (page 70).
- 2 Touch  (Playback Settings) to call up the Playback Settings menu.



NOTE

The Playback Settings can also be controlled from the Home display and Lyrics display.

- 3 Touch [Guide] to turn it on.
- 4 Touch [Right] to turn off the right-hand part.
The right-hand part is muted and the Guide for the right-hand part is enabled.

NOTE

Usually, Ch 1 is assigned to [Right], Ch 2 is assigned to [Left], and Ch 3 – 16 are assigned to [Extra], but you can change which channel is assigned to the right- or left- hand part via [Menu] → [SongSetting] → [Part Ch]. You can turn each channel on or off from the Mixer display (page 100).

- 5 Press the SONG CONTROL  (Play/Pause) button to start playback.

Practice the right-hand part at your own pace along with the guide lamps. The playback of the Left and Extra parts will wait for you to play the notes correctly.

NOTE

The guide lamps light in white for the white keys and in blue for the black keys.

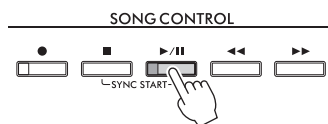

After you've finished practicing, touch [Guide] to turn off the Guide function.

Other guide functions

In addition to the “Follow Lights” function explained above, there are more functions in the Guide features, for practicing the timing of playing the keys (Any Key mode), for Karaoke or for practicing a song at your own pace (Your Tempo). You can select the functions via [Menu] → [SongSetting] → [Guide] → [Type]. For more information, refer to the Reference Manual on the website (page 9).

Repeat Playback

MIDI

Audio



The Song Repeat functions can be used to repeatedly play back a Song or a specific range of measures in a Song. This function controlled in the Song area (when expanded) of the Home display is useful for repeated practicing of difficult-to-play phrases.

NOTE

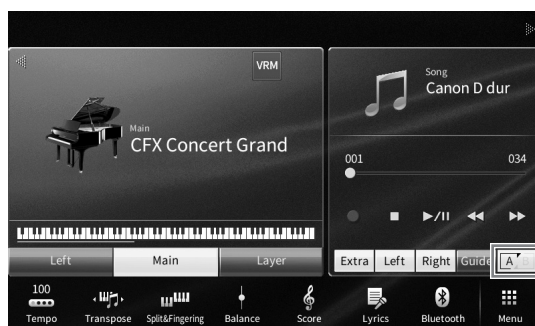
When a MIDI Song is selected, you can control Repeat playback also on the Playback Settings menu called up from the Score display or Lyrics display (page 72).





Playing an Entire Song Repeatedly

To repeat an entire Song, turn on  (A-B Repeat) in the display and start playback of the Song. To cancel Repeat playback, turn off  (A-B Repeat).

Specifying a Range of Measures and Playing them Back Repeatedly (A-B Repeat)

- 1 Select a Song (steps 1 – 2 on page 68).
- 2 Touch  (Play/Pause) to start playback.
- 3 Specify the repeat range.

When playback reaches the point you want to specify as the starting point (A), turn on  (A-B Repeat). When playback reaches the point you want to specify as the ending point (B), touch  (A-B Repeat) again. The range from Point A to Point B will be played back repeatedly. For MIDI Songs, an automatic lead-in (to help guide you into the phrase) is added before Point A.

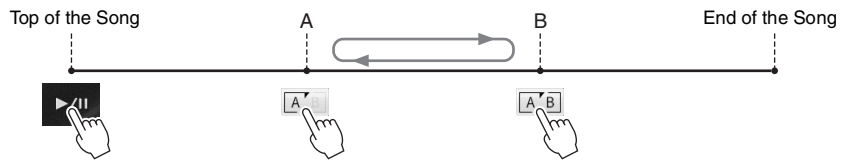

NOTE

- When you want to repeat from the top of the song to somewhere in the middle of the song:
 1. Turn on the A-B Repeat icon, and then start Song playback.
 2. Touch the A-B Repeat icon again at the desired ending point (B).
- Specifying only Point A results in repeat playback between Point A and the end of the Song.

4 Touch [■] (Stop) to stop playback.

The Song position will return to Point A.
After your practice, turn off [A,B] (A-B Repeat).

Specifying the repeat range while Songs are stopped

1. Fast-forward the Song to Point A then turn on [A] (A-B Repeat).
2. Fast-forward the Song to Point B then touch [A,B] (A-B Repeat) again.

Playing Multiple Songs Repeatedly

You can play several songs repeatedly. Select “All” or “Random” in “Repeat Mode” ([Menu] → [SongSetting] → [Play]), and then touch [▶/||] (Play/Pause) to start playback. All Songs saved in a designated folder will then be played repeatedly in either consecutive order or random order. To reset the repeat setting, select “Off” in “Repeat Mode.”

Adjusting the Pitch in Semitones (Pitch Shift)

MIDI

Audio

Like the Transpose function (page 41) of the MIDI Song, the pitch of an Audio Song in the USB flash drive can be adjusted in semitone steps (from -12 to 12) on the Home display.

1 Connect the USB flash drive containing Audio Songs to the [USB TO DEVICE] terminal.

NOTE

Before using a USB flash drive, be sure to read “Connecting USB Devices” on page 103.

2 Select an Audio Song (steps 1 – 2 on page 68).

- 3 In the Song area (when expanded) of the Home display, touch  0 (Pitch Shift) to call up the Setup window.

NOTE

Pitch Shift cannot be applied to MP3 files of 48.0 kHz sample rate.





- 4 Set the value by touching []/[].

Adjusting the Playback Speed (Time Stretch)

MIDI

Audio

Like Tempo adjustment of a MIDI Song (page 39), you can adjust the playback speed of an Audio Song in USB flash drive by stretching or compressing it. To do this, select an Audio Song then touch  100% (Time Stretch) in the Song area of the Home display to call up the Setup window. Touch []/[] in this window to set the value (from 70% to 160%). Higher values result in a faster tempo.



NOTE

Playback speed cannot be changed for MP3 files of 48.0 kHz sampling rate.

Canceling the Vocal Part (Vocal Cancel)

MIDI

Audio

You can cancel or attenuate the center position of the stereo sound. This lets you sing “karaoke” style with just instrumental backing, or play the melody part on the keyboard, since the vocal sound is usually at the center of the stereo image in most recordings.

To turn the Vocal Cancel function on/off, first select an Audio Song, and then turn on/off  (Vocal Cancel) in the Song area of the Home display.



NOTE

- Though the Vocal Cancel function is highly effective on most audio recordings, the vocal sound on some songs may not be completely canceled.
- Vocal cancel does not affect the Audio Input Sound (page 107) from external devices.

6 Song Recording

– Recording Your Performance –

This instrument allows you to record your performance in the following two methods.

• MIDI Recording

With this method, recorded performances are saved to the User memory of the instrument or a USB flash drive as an SMF (format 0) MIDI file. If you want to re-record a specific section or change Voices and edit other parameters, use this method. Also if you want to record your performance to each channel one by one, execute Multi Track Recording of the MIDI recording method. Since a MIDI Song can be converted to an Audio Song after recording (page 85), you may want to use MIDI recording (with overdubbing and multiple parts) to first create a complex arrangement you would not otherwise be able to play live, and then convert it to an Audio Song. This instrument allows you to record approximately 3 MB per Song.

• Audio Recording

With this method, recorded performances are saved to the User memory of the instrument or a USB flash drive as Audio files. Since they are saved in stereo WAV format of normal CD quality resolution (44.1 kHz/16-bit) by default, they can be transmitted to and played on portable music players by using a computer. The sound input from [MIC/LINE IN] jack, [AUX IN] jack, etc. is also recorded, so you can record your singing voice through the microphone or the sound played back on the connected audio device. The file format can be changed to MP3 via [Menu] → [SongSetting] → [Rec] → [Audio Rec Format]. This instrument allows you to record up to 80 minutes per single recording.

NOTE

For a general overview of MIDI and how you can effectively use it, refer to “MIDI Basics” on the website (page 9).

Quick and easy recording of your piano performance

If you simply want to play a piano piece and record it without having to make any complicated settings, you can do this by recording in the Piano Room. In this special display, you can start recording with just a single touch. For details, refer to page 48.

Basic Procedure for Recording (MIDI/Audio Recording)

Before recording, make the necessary settings such as Voice/Style selection (for MIDI Recording and Audio Recording) and the microphone connection (only for Audio Recording, if you want to record your vocal). As necessary, connect the USB flash drive to the [USB TO DEVICE] terminal, especially if you want to execute Audio Recording.

NOTE

Before using a USB flash drive, be sure to read “Connecting USB Devices” on page 103.

Before starting Audio Recording:

In Audio Recording, the performance data is automatically saved to the USB flash drive or User memory while recording. If you want to save the data to a USB flash drive, connect the USB flash drive to the [USB TO DEVICE] terminal beforehand. If it is not connected, the recorded data is automatically saved to User memory.

- 1 Make the necessary settings such as Voice and Style selection.
- 2 On the Home display, touch [▶] at the upper right to expand the Song area, and then touch [●] (Rec) to call up the Song Recording window.

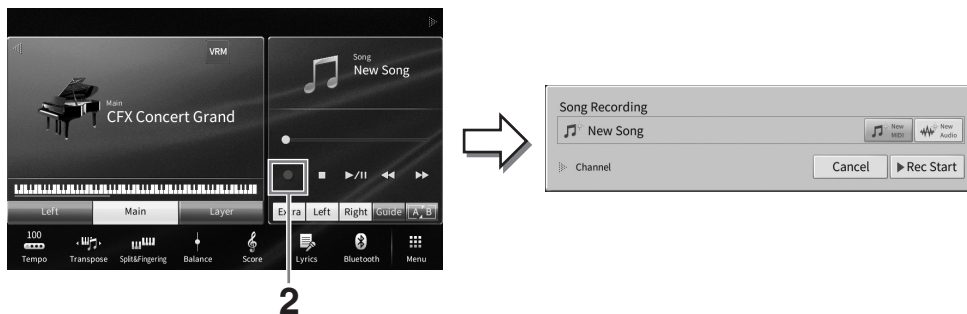

NOTE

- The Song Recording window can be called up also by pressing the SONG CONTROL [●] (Rec) button. Here and in the later steps, the operation in the Song area of the Home display can be controlled by the SONG CONTROL buttons (page 69).
- On the Song Recording window, touching the triangle at the left of “Channel” lets you expand or close the Channel (part) area.

- 3 Touch [New MIDI] for MIDI recording, or [New Audio] for Audio recording to select the desired recording type.

When a MIDI Song has been selected, [Overwrite MIDI] also appears in the window. Selecting it allows you to add or overwrite data of the selected MIDI Song.

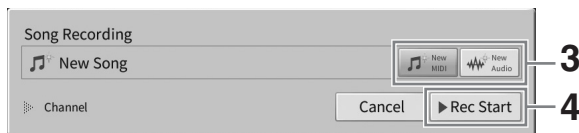

NOTE

If you want to cancel recording, touch [Cancel] in the display or press the SONG CONTROL [●] (Rec) button before going on to the next step.

- 4 Start recording.

With MIDI Recording, you can start recording either by playing the keyboard or touching [Rec Start]. With Audio Recording, start recording by touching [Rec Start]. You can also start recording by pressing the SONG CONTROL [▶/||] (Play/Pause) button.

Part Assignment to Channels (MIDI Recording)

With MIDI Recording, you can record your performance to each channel one by one (page 82). When you execute MIDI Recording without specifying the part as explained here, the keyboard parts will be recorded to channels 1 – 3 and the Style parts will be recorded to channels 9 – 16.

- 5 Play the keyboard.



- 6 After you finish your performance, touch [■] (Stop) on the Home display to stop recording.

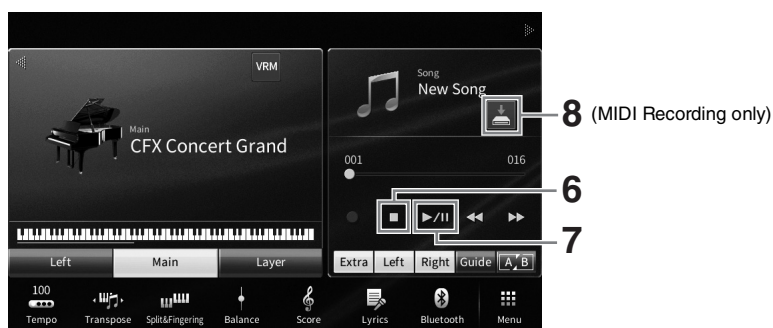

- 7 To hear the recorded performance, touch [▶/||] (Play/Pause).

- 8 Save the recorded performance.

■ **In MIDI Recording**

After recording,  (Save) appears in the Song area of the Home display. This icon indicates that recorded data exists but has not yet been saved.

8-1 On the Home display, touch  (Save) shown in the Song area to call up the display for selecting a destination to save the recorded Song.

8-2 Save the recorded data as a file by following the instructions on page 32, steps 2 – 5.

MIDI Songs can be saved to  (User MIDI Song tab).

NOTICE

The recorded MIDI Song will be lost if you change to another Song or you turn the power off without executing the save operation. This also occurs when the power is turned off by the Auto Power Off function (page 19).

■ **In Audio Recording**

Since the Audio Song file is automatically saved to the USB flash drive or User memory while recording, the Save operation is not required. The recorded Audio Song will appear in the  (User Audio Song tab) on the Song Selection display. If desired, rename the file name by following the instructions on page 33.

Re-recording a Specific Section of the MIDI Song

You can re-record a specific section of an already-recorded MIDI Song. For details, refer to the “SongSetting” section in the Reference Manual on the website (page 9).

Independently Recording the Right- and Left-hand Parts (MIDI Recording)

With MIDI Recording, you can create a MIDI Song which consists of 16 channels (parts) by recording each channel independently, allowing you create a complete piece which may be difficult to play live. For example, you can record the right-hand part first and then record the left-hand part while listening to the already recorded right-hand part, or you can record the Style playback first and then record melodies while listening to the already recorded Style playback.

Here, you will learn how to record right-hand and left-hand parts separately. If you want to specify the channels and parts to record, refer to page 82 for instructions.

- 1 Make necessary settings and call up the Song Recording window, and then touch [New MIDI] (steps 1 – 3 on page 77).**

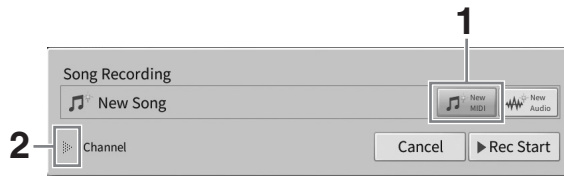

- 2 Touch [▶] at the left of “Channel” to expand the Channel area.**

- 3 Touch [Right Hand] to specify the target channels for recording the right-hand parts.**

Touching [Right Hand] sets “Main” and “Layer” to [Rec], and other parts to [Off]. The target channel for recording is automatically set in this way: Main part to channel 1, and Layer part to channel 3. If the Layer part is turned off from the Home display, the Layer part will not be recorded even when the Layer part is set to [Rec] here (silence will be recorded to the channel).

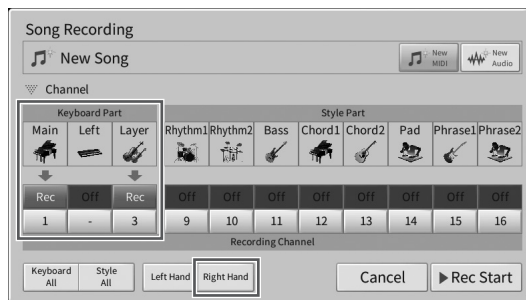

NOTE

- The target channels are automatically set here, however, you can also specify the channels to which each part will be recorded (page 82).
- If you want to cancel recording, touch [Cancel] in the display or press the SONG CONTROL [●] (Rec) button before going on to the next step. The [Rec]/[Off] and channel settings will also be canceled.

- 4 Play the keyboard with your right hand to start recording.**

You can also start recording by touching [Rec Start] or pressing the SONG CONTROL [▶/||] (Play/Pause) button.



- After you finish your performance, touch **[■]** (Stop) on the Home display to stop recording.



- To hear the recorded performance, touch **[▶/||]** (Play/Pause).
If you want to record the right-hand performance from scratch, return to step 1.
Since recording of the right-hand part is completed, go on to the next step to record the left-hand part.
- Touch **[●]** (Rec) to call up the Song Recording window, and then confirm that **[Overwrite MIDI]** is selected.

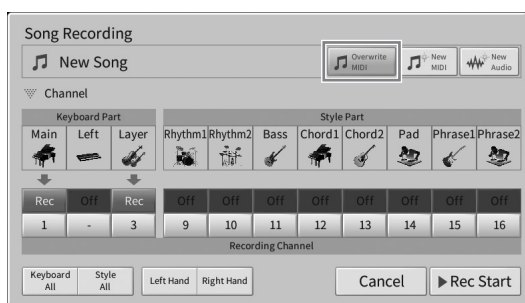

- Touch **[Left Hand]** to specify the target channel for recording the left-hand part.
 - When the Left part is turned off from the Home display**

Touching [Left Hand] sets "Main" and "Layer" to [Rec], and other parts to [Off]. The target channel for recording is automatically set in this way: Main part to channel 2, and Layer part to channel 4. If the Layer part is turned off from the Home display, the Layer part will not be recorded even when the Layer part is set to [Rec] here (silence will be recorded to the channel).

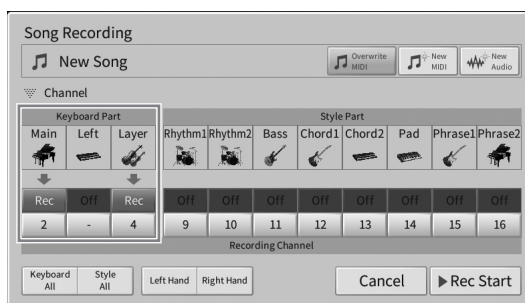

■ When the Left part is turned on from the Home display

Touching [Left Hand] sets only “Left” to [Rec], and other parts to [Off]. The target channel for recording Left part is automatically set to channel 2.

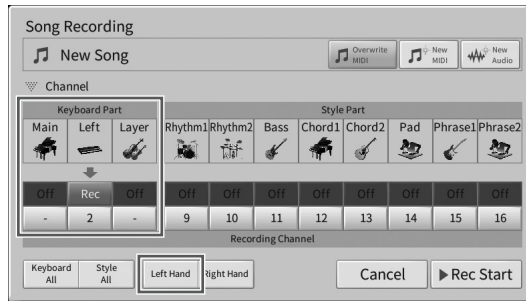

NOTICE

Previously recorded data will be overwritten if you set channels which already have recorded data to [Rec]. To check whether each channel has recorded data or not, first cancel recording, and then play back the Song while viewing the [Song Ch1-8] tab and [Song Ch9-16] tab on the Mixer display. The lamps of the channels which contain data will flash during Song playback.

NOTE

If you want to cancel recording, touch [Cancel] in the display or press the SONG CONTROL [●] (Rec) button before going on to the next step.

9 Play the keyboard with your left hand to start recording.

You can also start recording by touching [Rec Start] or pressing the SONG CONTROL [▶/||] (Play/Pause) button.



10 After you finish your performance, touch [■] (Stop) on the Home display to stop recording.



11 To hear the recorded performance, touch [▶/||] (Play/Pause).

If you want to re-record only the left-hand performance, return to step 7.

12 On the Home display, touch [Save] (Save) shown in the Song area to save the recorded performance.

When the display for selecting a destination appears, save the recorded data as a file by following the instructions on page 32, steps 2 – 5.

NOTICE

The recorded MIDI Song will be lost if you change to another Song or you turn the power off without executing the save operation. This also occurs when the power is turned off by the Auto Power Off function (page 19).

Recording to Specific Channels (MIDI Recording)

With MIDI Recording, you can create a MIDI Song which consists of 16 channels (parts) by recording each channel independently, allowing you create a complete piece. By default, keyboard parts are assigned to channels 1 – 3, and Style parts such as rhythm and bass are assigned to channels 9 – 16. Here, you will learn how to specify the channel and part for recording as you like, and overdub the channels one by one.

NOTE

If you want to add channel data to an existing Song, select the desired Song, make necessary settings, and then go on to step 7 here.

1 Make necessary settings and call up the Song Recording window, and then touch [New MIDI] (steps 1 – 3 on page 77).

If you want to re-record an existing MIDI Song, select the desired MIDI Song before calling up the Song Recording window. After doing that, touch [Overwrite MIDI].



2 Touch [▶] at the left of “Channel” to expand the Channel area.

3 Specify the target channel and part for recording.

3-1 From the display, set the part or parts you intend to record to [Rec], and set all other parts to [Off].

For example, if you want to record only the Style parts, set all Style parts to [Rec], and all keyboard parts to [Off].

3-2 Touch the channel number under the part(s) you set to [Rec] in step 3-1. In the setting display that appears, specify the channel (1 – 16) for recording.

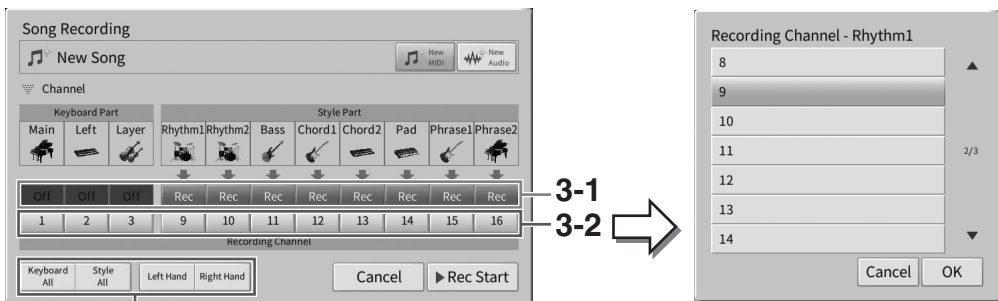

For quickly specifying recording parts

NOTICE

Previously recorded data will be overwritten if you set channels which already have recorded data to [Rec]. To check whether each channel has recorded data or not, first cancel recording, and then play back the Song while viewing the [Song Ch1-8] tab and [Song Ch9-16] tab on the Mixer display. The lamps of the channels which contain data will flash during Song playback.

NOTE

- Multiple parts can not be recorded to one channel.
- If you want to cancel recording, touch [Cancel] in the display or press the SONG CONTROL [●] (Rec) button before going on to the next step. The [Rec]/[Off] and channel settings will also be canceled.

Specifying recording parts quickly

Touching the buttons at the bottom left ([Keyboard All], [Style All], [Left Hand] or [Right Hand]) can set [Rec]/[Off] for multiple parts at once. This is convenient when you to separately record the Style parts and the keyboard parts, or the right-hand parts and the left-hand part.

- **[Keyboard All]:** You can turn all of the Keyboard parts (Main, Left and Layer) [Rec] or [Off] together.
- **[Style All]:** You can turn all of the Style parts [Rec] or [Off] together.
- **[Right Hand]:** This can be selected when recording only the right-hand part. The Main part of the Voice will be recorded to channel 1, and the Layer part will be recorded to channel 3.
- **[Left Hand]:** This can be selected when recording only the left-hand part. The Left part of the Voice will be recorded to channel 2. When the Left part of the Voice is off, the Main part will be recorded to channel 2 and the Layer part will be recorded to channel 4.

4 Play the keyboard to start recording.

Make sure to play the part(s) you specified in step 4. You can also start recording by touching [Rec Start] or pressing the SONG CONTROL [▶/||] (Play/Pause) button.

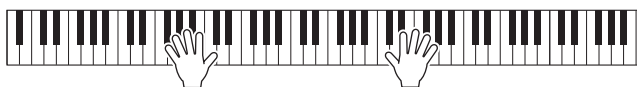

5 After you finish your performance, touch [■] (Stop) on the Home display to stop recording.

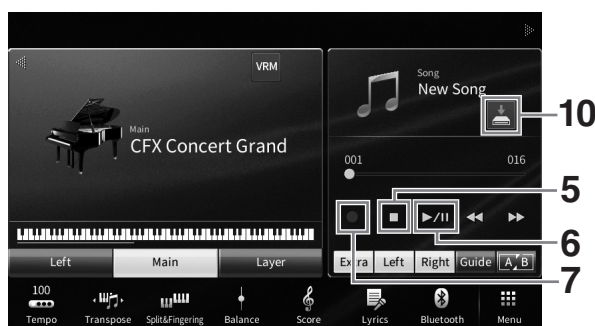

6 To hear the recorded performance, touch [▶/||] (Play/Pause).

Since recording of the first part is now completed, you can record another part. Make sure to make any necessary settings, and then go on to the next step.

- 7 Touch [●] (Rec) to call up the Song Recording window, and then confirm that [Overwrite MIDI] is selected.

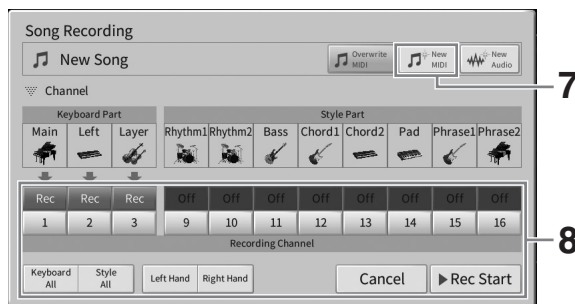

- 8 Specify the next target channel and part for recording, and record your performance (steps 3 – 6).

As soon as you start recording, the previously recorded channel also starts playback. You can set whether to play back the previously recorded channel(s) in the Mixer display (page 100).

NOTICE

Previously recorded data will be overwritten if you set channels which already have recorded data to [Rec]. To check whether each channel has recorded data or not, first cancel recording, and then play back the Song while viewing the [Song Ch1-8] tab and [Song Ch9-16] tab on the Mixer display. The lamps of the channels which contain data will flash during Song playback.

- 9 As necessary, repeat steps 7 – 8 to record other channels.

NOTE

To delete the recorded channel data, select the desired channel and start recording, and then touch [■] (Stop) to stop recording without playing the keyboard.

- 10 On the Home display, touch [Save] (Save) shown in the Song area to save the recorded performance.

When the display for selecting a destination appears, save the recorded data as a file by following the instructions on page 32, steps 2 – 5.

NOTICE

The recorded MIDI Song will be lost if you change to another Song or you turn the power off without executing the save operation. This also occurs when the power is turned off by the Auto Power Off function (page 19).

Converting a MIDI Song to an Audio Song

You can convert a recorded MIDI Song in the User memory or USB flash drive to an Audio Song. Conversion is executed by playing back the MIDI Song and re-recording it as an Audio Song. By default, the converted data is saved in WAV format, in the same way as Audio recording (page 76).

NOTE

Before using a USB flash drive, be sure to read “Connecting USB Devices” on page 103.

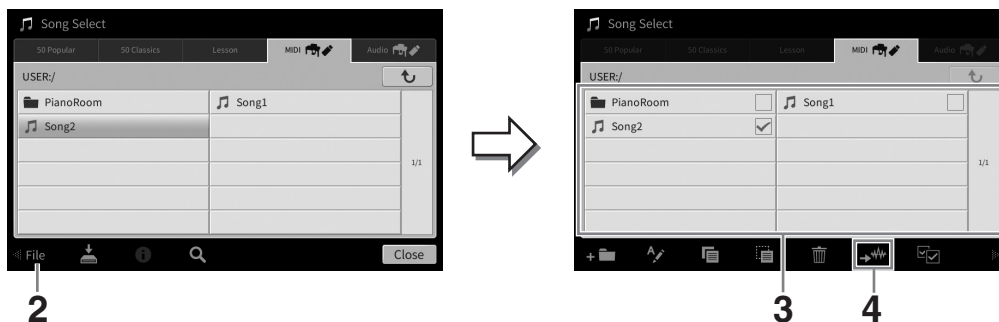

- 1 Call up the Song Selection display which contains the MIDI Song to be converted.
- 2 Touch [File] to call up the File Management icons.



- 3 Enter a checkmark to the MIDI Song to be converted.

NOTE

Audio Conversion can only be done one file at a time.

- 4 Touch  (Audio Convert) to call up the Song Selection display for selecting the Save destination.
- 5 Specify the Save destination location.
To show the next higher level folder, touch  (Above).
You can add a new folder by touching  (New Folder).
- 6 Touch [Convert] to start conversion.

This operation starts playback and conversion from MIDI to audio. If you play the keyboard or input audio signals via a microphone, the [AUX IN] jack, etc. during conversion, these sounds will also be recorded.

When conversion is completed, the message indicating that the conversion is being executed will no longer be shown in the display, and the newly created new Audio Song is shown in the Song Selection display.

7 Microphone

– Adding Vocal Harmony Effects to Your Singing –

By connecting a microphone to the [MIC/LINE IN] jack (standard mono phone jack), you can enjoy singing along with your keyboard performance or with Song playback. The instrument outputs your vocals through the built-in speakers. Moreover, you can automatically apply various Vocal Harmony effects to your voice as you sing.

Connecting a Microphone

- 1 Before turning on the power of the instrument, set the [INPUT VOLUME] knob to the minimum position.**

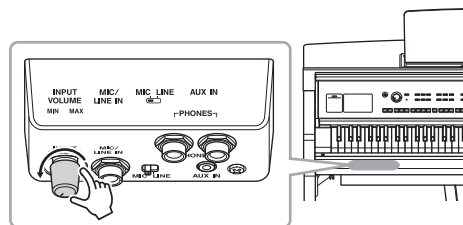

- 2 Connect the microphone to the [MIC/LINE IN] jack.**

NOTE

Make sure you have a conventional dynamic microphone.

- 3 Set the [MIC/LINE] switch to “MIC.”**

- 4 Turn on the power of the instrument.**

- 5 (If necessary, turn on the microphone.) Adjust the [INPUT VOLUME] knob while singing into the microphone.**

Adjust the control while checking the [MIC] lamp on the panel. Make sure to adjust the control so the lamp lights in blue. Make sure that the lamp does not light in red, since this indicates that the input level is too high.

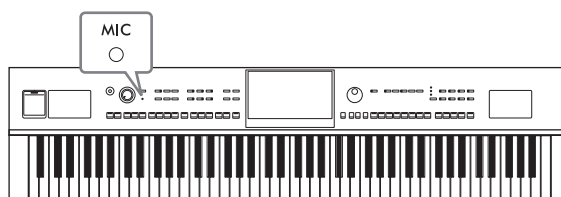
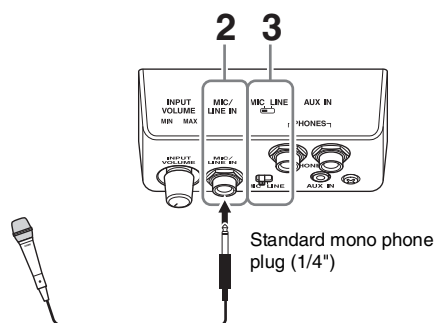

- 6 On the Balance display (page 42), adjust the volume balance between the microphone sound and the instrument sound.**

Disconnecting the microphone

1. Set the [INPUT VOLUME] knob to the minimum position.
2. Disconnect the microphone from the [MIC/LINE IN] jack.

NOTE

Before turning the power off, make sure to set the [INPUT VOLUME] knob to the minimum position.

Applying Vocal Harmony Effects to Your Voice

The Vocal Harmony feature lets you add harmonies to your singing voice, input via the microphone sound.

- 1 Connect the microphone to the instrument (page 86).
- 2 Call up the Vocal Harmony display via [Menu] → [VocalHarmony].

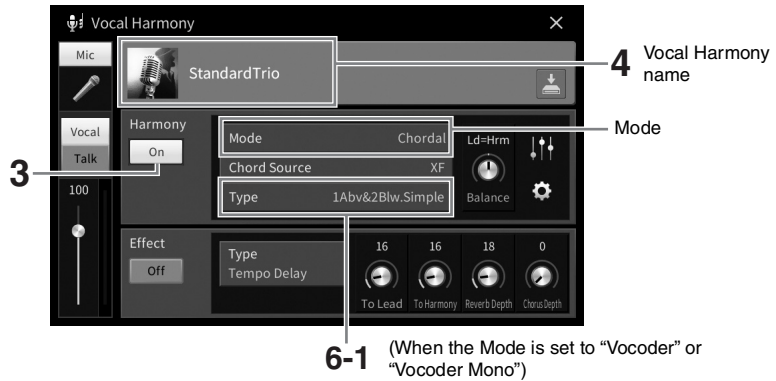

NOTE

The display shown at left is called up when the Harmony Mode is set to “Vocoder.” A different display appears when the Harmony Mode is set to “Chordal.”

- 3 Make sure that Harmony is set to “On.”
- 4 Touch the Vocal Harmony name to call up the Vocal Harmony Selection display.
- 5 Select a Vocal Harmony type.

The Vocal Harmony features three different Modes which can be selected automatically by selecting a Vocal Harmony type.

Harmony mode

Chordal	The harmony notes are determined by the chords you play in the chord section (with [ACMP ON/OFF] turned on), the left hand section (with [ACMP ON/OFF] turned off and the Left part turned on) or chord data of Song.
Vocoder	The microphone sound is output via the notes you play on the keyboard or the Song playback notes.
Vocoder-Mono	Same as the Vocoder basically. In this mode, only single-note melodies or lines can be played back (with last-note priority).

Icons shown in the Vocal Harmony Selection display indicate the following meanings.

- (Blue): Vocal Harmony type of Chordal mode.
- : Vocal Harmony type of Vocoder mode.
- : Vocal Harmony type having unusual effects, such as a robotic voice.
- (Gray): Vocal Harmony type without any effect.

NOTE

For details on Vocal Harmony types, refer to the Data List on the website (page 9).

6 Follow the steps below, depending on which Type (and mode) you selected.

■ If you selected the Chordal type:

6-1 Make sure that the [ACMP ON/OFF] button is turned on.

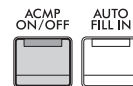

6-2 Play back a Style, or play back a Song which contains chords.

Vocal harmonies based on the chords are applied to your singing.

■ If you selected the Vocoder or Vocoder-Mono type:

6-1 As necessary, change the “Keyboard” setting to “Off,” “Upper,” or “Lower.”

When “Upper” or “Lower” is selected, playing the right-hand or left-hand section of the keyboard will control the Vocoder effect. When “Off” is selected, playing the keyboard will not control the Vocoder effect.

6-2 Play melodies on the keyboard or play back a Song, and sing into the microphone.

You’ll notice that you don’t actually have to sing pitched notes. The Vocoder effect takes the words you say and applies them to the pitch of the instrument sounds.

Useful functions for Karaoke

- Lyrics on the displaypage 71
- Transpose, Pitch Shift.....pages 41, 74
- Vocal Cancel.....page 75

Using the Talk Function

This function lets you instantly change the microphone settings for talking or making announcements between song performances.

To call up the Talk setting, touch [Talk] located at the left on the Vocal Harmony display. To recall the Vocal Harmony settings, touch [Vocal] and turn it on.

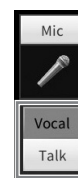

NOTE

You can adjust the microphone settings for Talk on the Mic Setting display called up via [Menu] → [MicSetting].

To get the most convenient use of this function, assign one of the pedals or ASSIGNABLE buttons to “Talk On/Off” ([Menu] → [Assignable]). For details, refer to the Reference Manual on the website (page 9).

8 Registration Memory/Playlist

– Saving and Recalling Custom Panel Setups –

The Registration Memory function allows you to save (or “register”) panel settings such as Voice and Style to a Registration Memory button, and then instantly recall your custom panel settings by simply pressing a single button. When you’ve saved lots of data to the Registration Memory, use the Playlist to manage your repertoire so that you can quickly call up the desired Registration Memory for each piece of music.

■ Registration Memory (page 90)

You can register your custom panel settings to each of the Registration Memory [1] – [8] buttons. You can also save all eight registered panel setups as a single Registration Memory Bank file. If you select a Registration Memory Bank file beforehand, you can easily call up the registered settings simply by pressing a button during your performance.

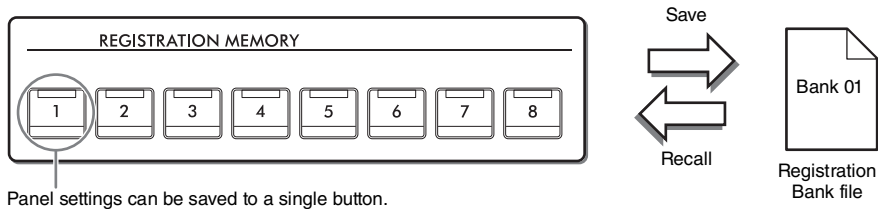

■ Playlist (page 94)

The Playlist function allows you to create custom performance lists. A Playlist contains links to call up Registration Memory Bank files for each piece you play. Each link to the Registration Memory is called a “Record,” and you can collectively store the Playlist Records as a single Playlist file. Each Playlist Record can directly recall a specified Registration Memory number in the selected Registration Memory Bank file. By using the Playlist, you can select only the desired files from the huge number of the Registration Memory Bank files without changing the bank file configuration.

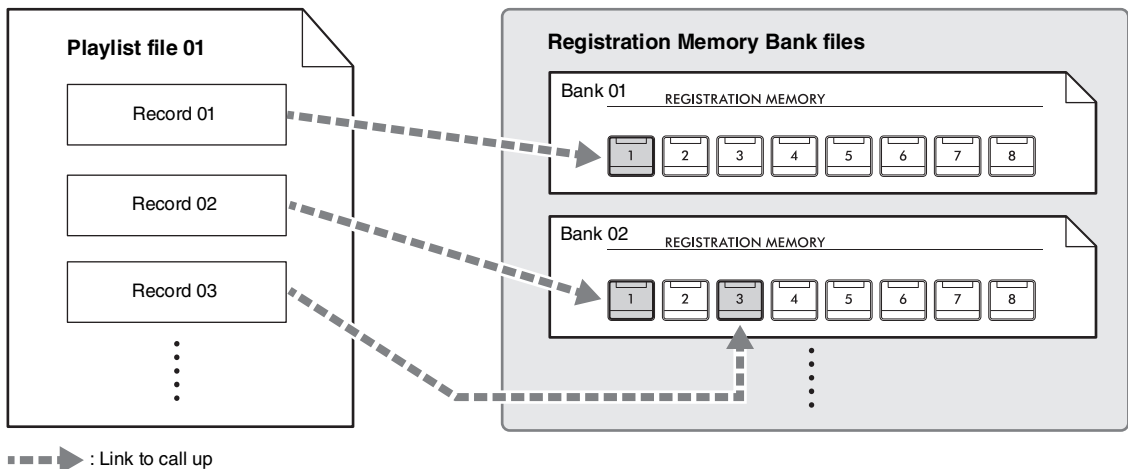

NOTE

By importing Music Finder Records (.mfd) used on previous Yamaha digital pianos (such as CVP-709, CVP-705, etc.), you can use the Records on the Playlist of this instrument, just like using the Music Finder function on those other instruments. For details, refer to the “Playlist” section in the Reference Manual on the website (page 9). For details on using Music Finder, refer to the Owner’s Manual of the Yamaha digital piano which contains your desired Music Finder Records.

Saving and Recalling Custom Panel Setups with Registration Memory

Registering Your Panel Setups

- 1 Set up the panel controls (such as Voice, Style and so on) as desired.**
Refer to “Parameter Chart” in the Data List on the website (page 9) for a list of parameters that can be registered with the Registration Memory function.
- 2 Press the [MEMORY] button in the REGISTRATION MEMORY section to call up the Registration Memory window.**

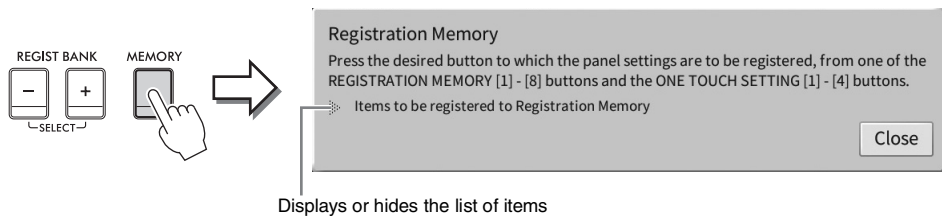

Selecting the items to be registered

Touching [▶] at the bottom left of the window calls up the list for selecting the items to be registered. Before going on to step 3, enter or remove checkmarks by touching the desired items. Items having checkmarks will be registered.

- 3 Press the desired REGISTRATION MEMORY [1] – [8] button to which you wish to memorize the panel setup.**

Memorized buttons are lit in red, indicating that the number button contains data and its number is selected.

NOTICE

If you select the button whose lamp is lit in red or green here, the panel setup previously memorized to the button will be erased and replaced by the new settings. Hence, you should memorize panel setups only to buttons that are turned off.

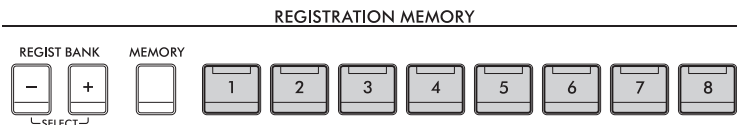

About the lamp status

- **White:** Data registered and currently selected
- **Blue:** Data registered but not currently selected
- **Off:** No data registered

- 4 Register various panel setups to other buttons by repeating steps 1 – 3.**

The registered panel setups can be recalled by simply pressing the desired number button.

NOTE

You can also disable recall of specific item(s) when calling up the registered panel setups: [Menu] → [RegistFreeze].

Saving the Registration Memory as a Bank File

All of the panel settings are registered to the eight Registration Memory buttons as a single Bank file.

- 1 On the Home display, touch [▶] at the upper right corner to show the Registration area, and then touch the area to call up the Registration Bank Selection display.**

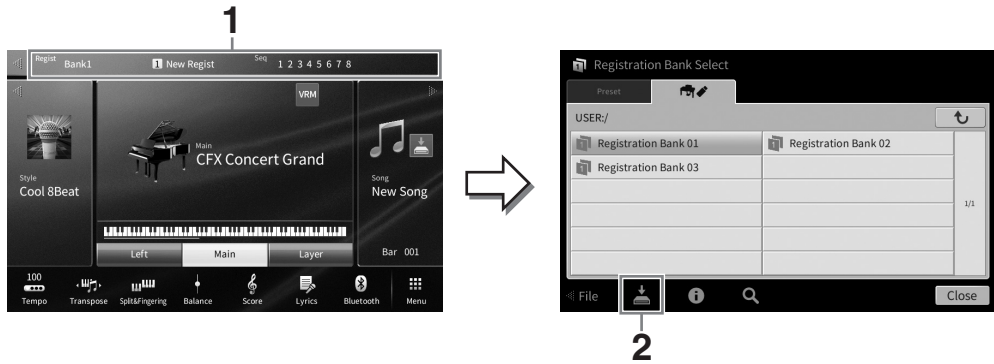

NOTE

In general, Registration Memory data (Bank files) is compatible between the CVP-909/CVP-905 and CVP-809/CVP-805. However, the data may not be perfectly compatible, depending on the specifications of each model.

The Registration Bank Selection display can be called up also by pressing the REGIST BANK [+] and [-] buttons simultaneously.

- 2 Touch  (Save) to save the Bank file.**

For instructions on saving, refer to page 32.

NOTE

If you rename, move or delete the Registration Bank file which is linked to a Playlist Record, the Registration Memory Bank cannot be called up from the Playlist.

Recalling a Registered Panel Setup

The saved Registration Memory Bank files can be recalled by using the REGIST BANK [-]/[+] buttons or the following procedure.

NOTE

- When recalling setups that include Song, Style or text files selected from a USB flash drive, make sure that the appropriate USB flash drive containing the registered Song, Style or text is connected into the [USB TO DEVICE] terminal. Before using a USB flash drive, be sure to read "Connecting USB Devices" on page 103.
- You can also call up the eight setups by using pedals in any order you specify via [Menu] → [RegistSeq]. For details, refer to the Reference Manual on the website (page 9).

- 1 Call up the Registration Bank Selection display (step 1 on page 91).**
- 2 Touch and select the desired Bank on the display.**
You can also use the REGIST BANK [-]/[+] buttons to select a Bank.
- 3 Press one of the blue-lit numbered buttons ([1] – [8]) in the Registration Memory section.**

Confirming the Registration Memory Information

You can call up the information window to confirm which Voices and Style are memorized to the [1] – [8] buttons of a Registration Memory Bank.

- 1 Call up the Registration Bank Selection display, and then select the desired Bank.
- 2 Touch **i** (Information) to call up the Registration Bank Information window. This display consists of two pages: Voice-related and Style-related. You can alternate between the two via **[▶]**/**[◀]**.

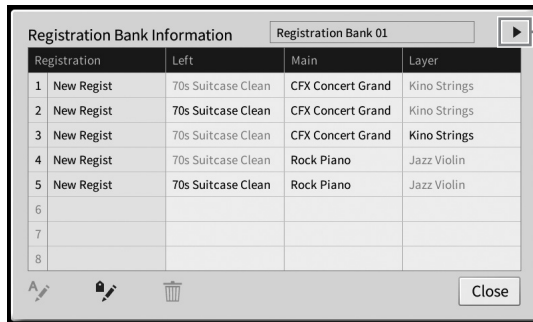



Registration	Left	Main	Layer
1 New Regist	70s Suitcase Clean	CFX Concert Grand	Kino Strings
2 New Regist	70s Suitcase Clean	CFX Concert Grand	Kino Strings
3 New Regist	70s Suitcase Clean	CFX Concert Grand	Kino Strings
4 New Regist	70s Suitcase Clean	Rock Piano	Jazz Violin
5 New Regist	70s Suitcase Clean	Rock Piano	Jazz Violin
6			
7			
8			

For switching the pages.

NOTE

If a certain Voice part is set to off, the Voice name for the corresponding part is shown in gray.

Select one of the Registration Memory numbers and touch the following icon to edit it.

- : Rename it.
- : Delete the data.
- : Add Tags (page 93) or edit it.

Filtering a Search for Registration Bank Files

On the Registration Bank Selection display, you can quickly find a desired file by filtering the search results (page 36).

- 1 On the Search display for the Registration Memory Bank files (page 36), touch **Filter** (Filter).

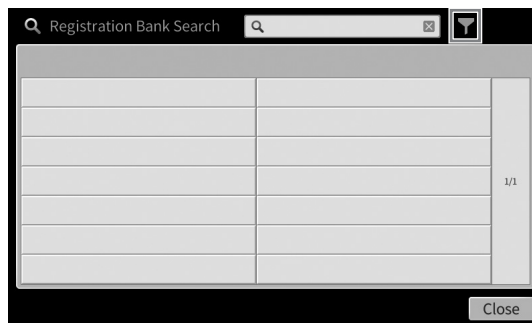

2 Enter the search options in the box.

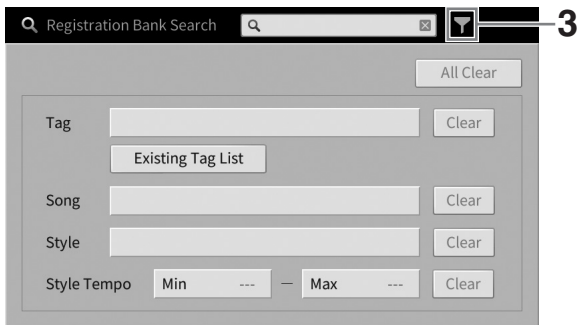

- **Tag:** Enter tags (see below) to the box, or select tags from the list by touching [Existing Tag List]. If you want to enter multiple tags to the box, insert a space between each tag.
- **Song:** Enter the Song name.
- **Style:** Enter the Style name.
- **Style Tempo:** Enter the Style tempo range.

To clear each search query, touch [Clear]. To clear all, touch [All Clear].

3 Touch (Filter) to show the search result.

Adding Tags on Registration Memory Bank for Search

The tags of Registration Memory Banks help you to quickly find desired files when searching.

1 On the Registration Bank Information window (page 92), touch (Tag) to call up the Tag Edit window.



2 Touch [New Tag] to call up the Character Entry window, and then enter the desired text.

If you have already added any tags to another Registration Memory Bank file, existing tags appear in the list and can be selected by entering checkmarks. It may take some time for the list to be shown.

3 Touch (Save) to register the tag information to the Registration Memory Bank file.

Using Playlists to Manage a Large Repertoire of Panel Setups

The Playlist is useful for managing multiple set lists for your performances. You can select only the desired files from a large repertoire (the huge number of the Registration Memory Bank files) and create a new set list for each performance.

Adding a Record (Link to a Bank file) to a Playlist

By adding Records to a Playlist, you can directly recall desired Registration Memory Bank files from the Playlist for each performance.

1 Call up the Playlist display via [Menu] → [Playlist].

The Playlist file which was selected the last time appears. (The sample preset Playlist will appear for the first time.)



2 If you want to create a new Playlist, touch (New).

3 Add a Record to the Playlist.

■ To add a Record via the Registration Bank Selection display:

3-1 Touch Add Record [List] to call up the Registration Bank Selection display.

3-2 Select the desired Bank file to register as a Playlist Record. Touching [Add to Playlist] closes the display, and the new Record is added to the bottom of the Playlist.

■ To add a Record by using the search function

3-1 Touch Add Record [Search] to search for the desired Registration Bank file.

3-2 From the search result, select the desired file. Touching [Add to Playlist] closes the display, and the new Record is added to the bottom of the Playlist.

4 If necessary, edit the Record.

The newly added Playlist Record simply recalls the selected registration Bank file. If you want to set more detailed settings (such as directly recalling a specified Registration Memory number), you can edit the Record.

4-1 Touch [Edit] to call up the Record Edit window.

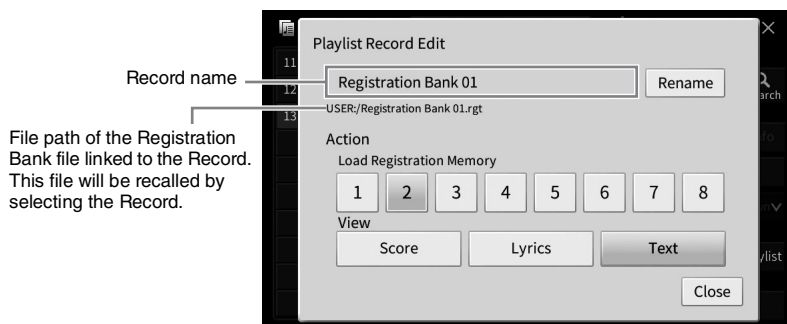

4-2 Touch to edit the Record.

(Record name)	Determines the name of the Record. Touching [Rename] calls up the Character Entry window.
Action	<p>Additional actions after selecting the Record and recalling the Bank.</p> <ul style="list-style-type: none"> • Load Registration Memory: Recalls the Registration Memory corresponding to the number selected here. When no item is selected, no Registration Memory is recalled. • View: Displays the view (score, lyrics or text) selected here. When no item is selected, no view is displayed. <p>NOTE This setting is shown at right of the Record name on the Playlist display.</p>

4-3 Touch [Close] to close the Record Edit display.

5 Touch (Save) to save the added Record to the current Playlist file.

To recall the registered Record, select the desired Record on the Playlist display (page 96).

Recalling Custom Panel Setups via the Playlist

- 1 Call up the Playlist display via [Menu] → [Playlist].

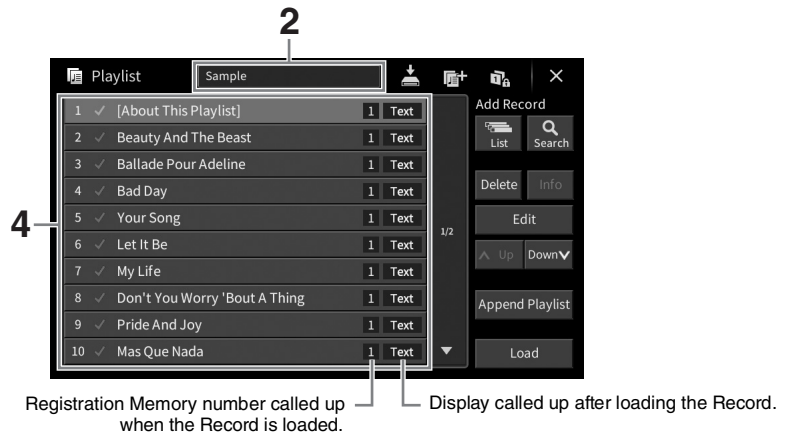

- 2 Touch the Playlist name to call up the Playlist Selection display.
- 3 Select the desired Playlist file.
- 4 Select the Record name on the Playlist display, and then touch [Load].
The Registration Memory Bank registered as the Playlist Record is recalled and the Action you've made (page 95) is executed. You can load the Record also by touching the desired Record name twice.
Touching [Info] calls up the Registration Bank Information window (page 92).

Disabling Recall of Specific Panel Setups in the Registration Memory

Touching  (Freeze) at the upper right of the display calls up the Registration Freeze display. For details, refer to the "RegistFreeze" section in the Reference Manual on the website (page 9).

Changing the Order of the Records in the Playlist

- 1 On the Playlist display, touch the desired Record to move.
- 2 Touch [Up] or [Down] to move the Record you selected in step 1.
- 3 Touch  (Save) to save the edited Playlist file.

Deleting the Record from the Playlist

- 1 On the Playlist display, touch the desired Record to delete.**
- 2 Touch [Delete].**
A confirmation message appears. If you want to cancel the operation, touch [No] here.
- 3 Touch [Yes] to delete the Record.**
- 4 Touch  (Save) to save the edited Playlist file.**

Copying the Playlist Records from Another Playlist (Append Playlist)

“Append Playlist” allows you to copy the existing Playlist file and add it to the current Playlist file.

- 1 Touch [Append Playlist] to call up the Playlist File Selection display.**
- 2 Touch the desired Playlist file to append.**
A confirmation message appears. If you want to cancel the operation, touch [No] here.
- 3 Touch [Yes] to add the Records.**
All Records in the selected Playlist file are added at the bottom of the current Playlist.
- 4 Touch  (Save) to save the appended Records to the current Playlist file.**

9 Mixer

– Editing the Volume and Tonal Balance –

The Mixer gives you intuitive control over aspects of the keyboard parts and Song/Style channels, including volume balance and the timbre of the sounds. It lets you adjust the levels and stereo position (pan) of each Voice to set the optimum balance and stereo image, and lets you set how the effects are applied.

This chapter covers the basic procedures for the Mixer. For details, refer to the Reference Manual on the website (page 9).

Basic Procedure for the Mixer

- 1 Call up the Mixer display via [Menu] → [Mixer].

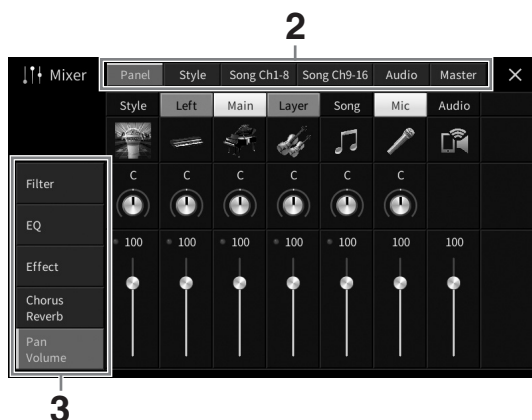

- 2 Touch a tab for editing the balance among the desired parts.

Panel	Use this display when you want to adjust the balance among the entire Song part, entire Style part, Mic part, Audio Input part, Main part, Layer part and Left part.
Style	Use this display when you want to adjust the balance among the parts of the Style. <ul style="list-style-type: none"> • Rhythm1, Rhythm2 These are the basic parts of the Style, containing the drum and percussion rhythm patterns. • Bass The bass part uses various appropriate instrument sounds to match the Style. • Chord1, Chord2 These comprise the rhythmic chord backing, commonly consisting of piano or guitar Voices. • Pad This part is used for sustained instruments such as strings, organ, choir, etc. • Phrase1, Phrase2 These parts are used for punchy brass stabs, arpeggiated chords, and other extras that make the accompaniment more interesting.
Song Ch1-8 / 9-16	Use this display when you want to adjust the balance among all the parts of the MIDI Song. This is available only when a MIDI Song is selected.

Audio	Use this display when you want to adjust the balance among audio sounds input via the USB Audio Interface function and Bluetooth Audio function, etc. (page 107).
Master	Unlike the other displays, use this display when you want to adjust the tonal characteristics of the entire sound (except for Audio Songs) of this instrument.

3 Touch a tab for editing the desired parameters.

■ When a tab other than “Master” is selected in step 2:

Filter	For adjusting the Harmonic Content (resonance) and sound brightness.
EQ	For adjusting equalization parameters to correct the tone or timbre of the sound.
Effect	For selecting an Effect type and adjusting its depth for each part.
Chorus/Reverb	For selecting a Chorus/Reverb type and adjusts its depth for each part.
Pan/Volume	For adjusting panning and volume for each part.

■ When “Master” is selected in step 2:

Compressor	Lets you turn the Master Compressor (which is applied to the entire sound) on or off, select the Master Compressor type, and edit the related parameters. Your original edits can be saved as the Master Compressor type.
EQ	Lets you select the Master EQ type applied to the entire sound and edit the related parameters. Your original edits can be saved as the Master EQ type.

4 Set the value of each parameter.

NOTE

To reset each parameter to the default value, touch the number value or setting and hold it.

5 Save your Mixer settings.

■ To save the “Panel” Mixer settings:

Register them to Registration Memory (page 90).

■ To save the “Style” Mixer settings:

Save them as a Style file to the User memory or USB flash drive. If you want to recall the settings for future use, select the Style file saved here.

1. Call up the operation display via [Menu] → [StyleCreator].
2. Touch  (Save) to call up the Style Selection display, and then save as a Style file (page 32).

■ To save the “Song Ch 1-8/9-16” Mixer settings:

First register the edited settings as part of the Song data (Setup), and then save the Song to the User memory or USB flash drive. If you want to recall the settings for future use, select the Song file saved here.

1. Call up the operation display via [Menu] → [SongCreator] → [Channel Edit].
2. Touch [Setup].
3. Touch [Execute] to execute the Setup.

4. Touch  (Save) to call up the Song Selection display, and then save as a Song file (page 32).

■ **To save the “Audio” Mixer settings:**

Saving operation is not necessary. Audio Mixer settings are retained even when the power is turned off.

■ **To store the “Master” Mixer settings:**

Your original edits can be stored as a Master Compressor type and Master EQ type. If you want to recall the settings for future use, select the corresponding type at the upper right of each display.

1. Touch  (Save) in the “Compressor” display or “EQ” display.
2. Select one of User1 – User30, and then touch [Save] to call up the Character Entry window.
3. On the Character Entry window, change the name as necessary, and then touch [OK] to save the data.

Turning Each Channel of the Style or MIDI Song On/Off

The Mixer display lets you turn each channel of the current Style or MIDI Song on or off.

- 1 In the Mixer display, touch the [Style] tab, [Song Ch 1-8] tab or [Song Ch 9-16] tab.
- 2 Touch the Channel which you want to turn on or off.



If you want to solo a specific channel, touch and hold the desired channel until the number turns green. To cancel solo, simply touch the (green) channel number again.

To change the Voice for each channel:

Touch the instrument icon below the channel number to call up the Voice Selection display, and then select the desired Voice.

- 3 As necessary, make other settings then save them as a Style file or Song file (step 5 on page 99).

10 Connections

– Using Your Instrument with Other Devices –

CAUTION

Before connecting the instrument to other electronic devices, turn off the power of all the devices. Also, before turning any devices on or off, make sure to set all volume levels to minimum (0). Otherwise, damage to the devices, electrical shock, or even permanent hearing loss may occur.

NOTICE

Do not place any devices in an unstable position. Doing so may cause the device to fall and result in damage.

I/O Connectors

To see where these connectors are located on the instrument, refer to page 15.

CVP-909 Grand Piano type

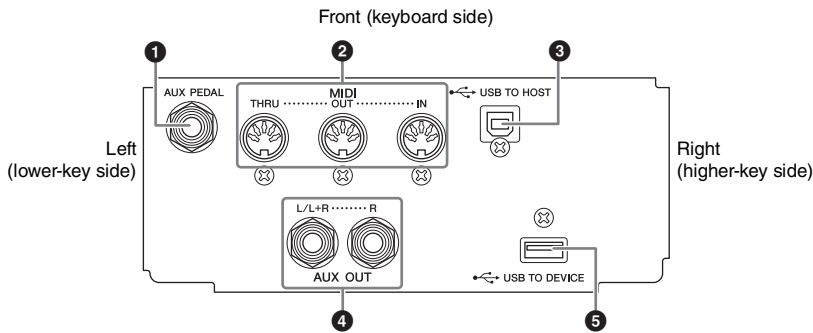

CVP-909/CVP-905

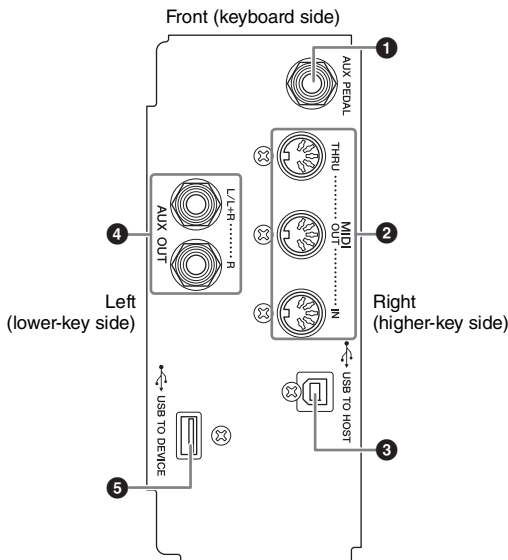

CVP-909 Grand Piano type/ CVP-909/CVP-905

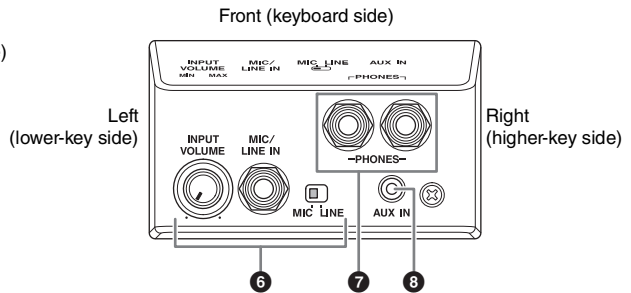

1 [AUX PEDAL] jack

For connecting a separately sold foot controller or footswitch (page 112).

2 MIDI terminals

For connecting to a computer or external MIDI device, such as a synthesizer or a sequencer (page 111).

3 [USB TO HOST] terminal

For connecting to a computer or smart device such as smartphone or tablet (page 105).

4 AUX OUT [L/L+R]/[R] jacks

For connecting to external powered speaker systems (page 110).

5 [USB TO DEVICE] terminal

For connecting a USB flash drive (page 103), USB display adaptor (page 111) or USB wireless LAN adaptor (page 106). Before using the [USB TO DEVICE] terminal, be sure to read "Precautions when using the [USB TO DEVICE] terminal" on page 103.

6 [MIC/LINE IN] jack, [MIC/LINE] switch, [INPUT VOLUME] knob

For connecting a microphone or guitar (pages 86 and 112).

7 [PHONES] jacks

For connecting headphones (page 20).

8 [AUX IN] jack

For connecting an audio player (page 107).

Connecting USB Devices ([USB TO DEVICE] terminal)

You can connect a USB flash drive, USB display adaptor or a USB wireless LAN adaptor to the [USB TO DEVICE] terminal. You can save data you've created on the instrument to the USB flash drive (page 32), as well as connect to an external monitor by using a USB display adaptor to show the instrument's display (page 111) or connect the instrument to a smart device via USB wireless LAN adaptor (page 106).

Precautions when using the [USB TO DEVICE] terminal

This instrument features a built-in [USB TO DEVICE] terminal. When connecting a USB device to the terminal, be sure to handle the USB device with care. Follow the important precautions below.

NOTE

For more information about the handling of USB devices, refer to the owner's manual of the USB device.

■ Compatible USB devices

- USB flash drive
- USB display adaptor
- USB wireless LAN adaptor (UD-WL01; sold separately)

Other USB devices such as a USB hub, computer keyboard or mouse cannot be used.

The instrument does not necessarily support all commercially available USB devices. Yamaha cannot guarantee operation of USB devices that you purchase. Before purchasing a USB device for use with this instrument, please visit the following web page:

<https://download.yamaha.com/>

Although USB devices 2.0 or 3.0 can be used on this instrument, the amount of time for saving to or loading from the USB device may differ depending on the type of data or the status of the instrument.

NOTICE

The rating of the [USB TO DEVICE] terminal is a maximum of 5V/500mA. Do not connect USB devices having a rating above this, since this can cause damage to the instrument itself.

■ Connecting a USB device

When connecting a USB device to the [USB TO DEVICE] terminal, make sure that the connector on the device is appropriate and that it is connected in the proper direction.

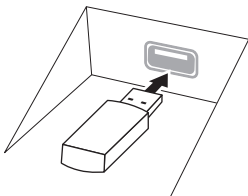

NOTICE

- When connecting a USB device to the [USB TO DEVICE] terminal on the top panel, remove it before closing the key cover. If the key cover is closed with the USB device connected, the USB device may be damaged.

- Avoid connecting or disconnecting the USB device while executing playback/recording and file management operations (such as Save, Copy, Delete and Format), or when accessing the USB device. Failure to observe this may result in "freezing" of the operation of the instrument or corruption of the USB device and the data.
- When connecting then disconnecting the USB device (and vice versa), make sure to wait a few seconds between the two operations.
- Do not use an extension cable when connecting a USB device.

Using USB flash drives

By connecting the instrument to a USB flash drive, you can save data you've created to the connected device, as well as read data from the connected USB flash drive.

■ Maximum number of USB flash drives

Up to two USB flash drives can be connected to the [USB TO DEVICE] terminals.

■ Formatting USB flash drives

You should format the USB flash drive only with this instrument (page 104). A USB flash drive formatted on another device may not operate properly.

NOTICE

The format operation overwrites any previously existing data. Make sure that the USB flash drive you are formatting does not contain important data.

■ To protect your data (write-protect)

To prevent important data from being inadvertently erased, apply the write-protect provided with each USB flash drive. If you are saving data to the USB flash drive, make sure to disable write-protect.

■ Turning off the instrument

When turning off the instrument, make sure that the instrument is NOT accessing the USB flash drive by playback/recording or file management (such as during Save, Copy, Delete and Format operations). Failure to do so may corrupt the USB flash drive and the data.

Formatting a USB Flash Drive

When a USB flash drive is connected, a message may appear indicating that the connected USB flash drive is not formatted. If so, execute the format operation.

NOTICE

The Format operation deletes any previously existing data. Make sure that the USB flash drive you are formatting does not contain important data. Proceed with caution, especially when connecting multiple USB flash drives.

- 1** Connect a USB flash drive for formatting to the [USB TO DEVICE] terminal.
- 2** Call up the operation display via [Menu] → [Utility] → [Storage].

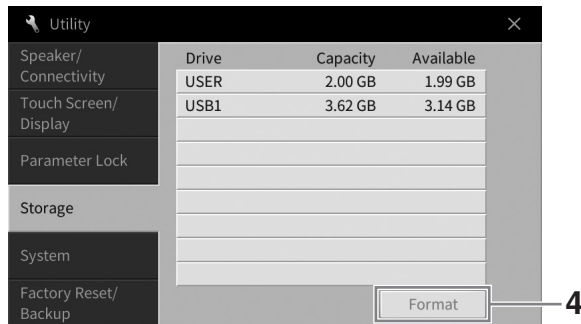

- 3** Touch the name of the USB flash drive to be formatted in the device list.
The indications USB 1, USB 2, etc. are displayed depending on the number of the connected devices. USER indicates the User memory of this instrument.
- 4** Touch [Format] to execute the Format operation.

Connecting to a Computer ([USB TO HOST] terminal)

By connecting a computer to the [USB TO HOST] terminal, you can transmit/receive MIDI data or Audio data between the instrument and the computer. For details on using a computer with this instrument, refer to the “Computer-related Operations” on the website (page 9).

CAUTION

If you are using a DAW (digital audio workstation) application with this instrument, set the Audio Loopback function (page 105) to off. Otherwise, a loud sound may occur, depending on the settings of the computer or the application software.

NOTICE

Use an AB type USB cable of less than 3 meters. USB 3.0 cables cannot be used.

Example

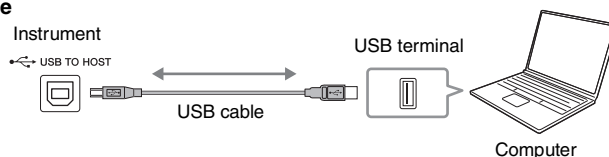

NOTE

- When using a USB cable to connect the instrument to your computer, make the connection directly without passing through a USB hub.
- The instrument will begin transmission a short time after the computer is connected.
- Unexpected sounds may occur if you edit MIDI data related to the Grand Expression Modeling (page 53) on a computer.

Transmitting/Receiving Audio Data (USB Audio Interface function)

By connecting a computer or a smart device to the [USB TO HOST] terminal via a USB cable, digital audio data can be transmitted/received. This USB Audio Interface function provides the following advantages:

■ Playing back audio data with high sound quality

This gives you direct, clear sound in which the sound quality has less noise and deterioration than that from the [AUX IN] jack.

■ Recording performance on the instrument as audio data by using a recording software or a music production software

The recorded audio data can be played back on the computer or smart device.

NOTE

- When transmitting or receiving audio signals by using a computer running Windows, the Yamaha Steinberg USB Driver should be installed to the computer. For details, refer to the “Computer-related Operations” on the website.
- For instructions on connecting to a smart device, refer to the “Smart Device Connection Manual” on the website.

Turning Audio Loopback On/Off

This allows you to set whether Audio Input Sound (page 107) from the external device is output to a computer or a smart device or not along with the performance played on the instrument. To output the Audio Input Sound, set the Audio Loopback to “On.”

For example, if you want to record the Audio Input Sound as well as the sound played on the instrument by using the connected computer or smart device, set this to “On.” If you intend to record only the sound played on the instrument by using the computer or smart device, set this to “Off.”

The setting can be made via [Menu] → [Utility] → [Speaker/Connectivity] → [Audio Loopback].

NOTE

- With Audio Recording (page 76), the Audio Input Sound from the external device is recorded when this is set to “On,” and not recorded when set to “Off.”
- The sound cannot be output to a device connected by the [AUX IN] jack or Bluetooth.

Connecting to a Smart Device ([AUX IN] jack/Bluetooth/[USB TO HOST] terminal/Wireless LAN)

Connecting a smart device such as a smartphone or tablet provides the following advantages:

- By connecting via the [AUX IN] jack (page 107) or Bluetooth (page 108), you can hear the sound of the smart device through the built-in speakers of the instrument.
- By connecting via the [USB TO HOST] terminal, you can transmit/receive audio data (USB Audio Interface function; page 105).
- By connecting via a USB wireless LAN adaptor (UD-WL01; sold separately) or USB cable, you can use compatible smart device apps.

For instructions on connection by using a method other than via [AUX IN] jack or Bluetooth, refer to the “Smart Device Connection Manual” on the website (page 9).

NOTICE

- Use an AB type USB cable of less than 3 meters. USB 3.0 cables cannot be used.
- Do not connect this product to a public Wi-Fi and/or Internet service directly. Only connect this product to the Internet through a router with strong password protections. Consult your router manufacturer for information on optimum security practices.

Example

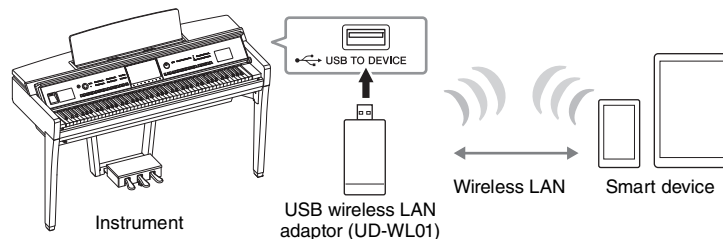

NOTE

- The USB wireless LAN adaptor (UD-WL01) may not be available depending on your area.
- When you use your smart device near the instrument, we recommend that you enable “Airplane Mode” on the device to avoid noise caused by communication. When wirelessly connecting a smart device with this product, make sure that the Wi-Fi or Bluetooth setting on the device is turned on.
- Before using the [USB TO DEVICE] terminal, be sure to read “Precautions when using the [USB TO DEVICE] terminal” on page 103.
- When using a USB cable to connect the instrument to your smart device, make the connection directly without passing through a USB hub.
- The instrument will begin transmission a short time after the smart device is connected.
- You can set whether Audio Input Sound from the external device is output to a computer or smart device or not along with the performance played on the instrument. For details, refer to the section on Audio Loopback on page 105.

Using a Smart Device App

By connecting this instrument to a smart device, you can use the apps below to make using it more convenient and more enjoyable.

■ Smart Pianist

This app lets you record your performance to the smart device, or use the “Audio to Score” function which allows you to view the score of the audio data in the smart device.

■ Rec'n'Share

This app lets you record audio and video of your performance in high sound quality (without noise such as voices around you), and share the recorded data on the Internet.

For details on these apps and compatible smart devices, access the web page of the respective apps on the following page:

<https://www.yamaha.com/kbdapps/>

Listening to Audio Playback by the External Device through the Instrument's Speaker ([AUX IN] jack/Bluetooth/[USB TO HOST] terminal)

Audio playback by the connected device can be output from the instrument's speaker. To input audio, connect an external device by one of the following methods.

- Connecting to the [AUX IN] jack by using an audio cable
- Connecting by Bluetooth (Bluetooth Audio function)
- Connecting to the [USB TO HOST] terminal by using a USB cable (USB Audio Interface function; page 105)

When connecting to a smart device, you can also connect by using a USB wireless LAN adaptor (UD-WL01; sold separately). For information about connection with a smart device, refer to page 106.

Audio Input Sound:

In this manual, "Audio Input Sound" refers to audio input to the instrument from the external devices connected by these methods.

NOTE

- The volume of the Audio Input Sound can be adjusted from the external device.
- You can adjust the volume balance among the sounds of the instrument and the Audio Input Sound in the Balance display (page 42).
- You can set whether Audio Input Sound from the external device is output to a computer or a smart device or not along with the performance played on the instrument. For details, refer to "Turning Audio Loopback On/Off" on page 105.

Connecting to an Audio Player by using an Audio Cable ([AUX IN] jack)

You can connect the headphone jack of an audio player such as a smartphone and portable audio player to the instrument's [AUX IN] jack. Audio playback on the connected device is output from the built-in speakers of this instrument.

NOTICE

To avoid damage to the devices, first turn on the power to the external device, and then to the instrument. When turning off the power, first turn off the power to the instrument, and then to the external device.

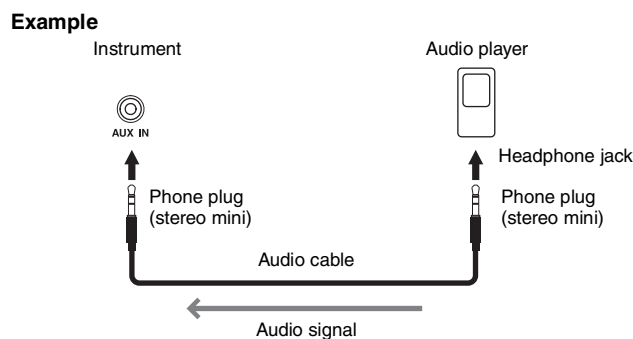

NOTE

Use audio cables and adaptor plugs having no (zero) resistance.

Minimizing noise of the input sound via Noise Gate

By default, this instrument cuts unwanted noise from the input sound. However, this may result in wanted sounds also being cut, such as the soft decay sound of a piano or acoustic guitar. To avoid this, set the Noise Gate to off via [Menu] → [Utility] → [Speaker/Connectivity] → [AUX IN Noise Gate].

Listening to Audio data from a Bluetooth-equipped device through this instrument (Bluetooth Audio Function)

Before using the Bluetooth function, be sure to read “About Bluetooth” on page 109.

You can play the sound of audio data saved in a Bluetooth-equipped device, such as a smartphone or portable audio player, on this instrument and listen to it through the built-in speaker of the instrument.

Bluetooth-equipped device:

In this manual, “Bluetooth-equipped device” refers to a device that can transmit audio data saved in it to the instrument using the Bluetooth function, via wireless communication. For proper operation, the device must be compatible with A2DP (Advanced Audio Distribution Profile). The Bluetooth Audio function is explained here by using a smart device as an example of such Bluetooth-equipped devices.

Example

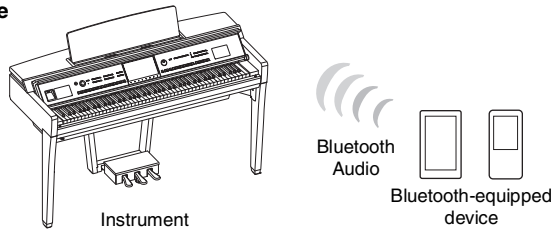

Bluetooth capability

Depending on the country in which you purchased the product, the instrument may not have Bluetooth capability.

If the Bluetooth icon is shown in the Menu display, this means that the product is equipped with Bluetooth functionality.

The screenshot shows the instrument's menu screen. The top bar is labeled "Menu". The main area contains several icons for functions: VoiceEdit, StyleCreator, SongCreator, VoiceSetting, StyleSetting, and SongSetting. Below these are Tuning, Keyboard, Metronome, MIDI, Utility, and a Bluetooth icon which is highlighted with a white box and labeled "Bluetooth icon". At the bottom, there are icons for WirelessLAN, Time, Tempo, Transpose, Splitting, Balance, Score, Lyrics, Bluetooth, and Menu.

1 Call up the Bluetooth display via [Menu] → [Bluetooth].

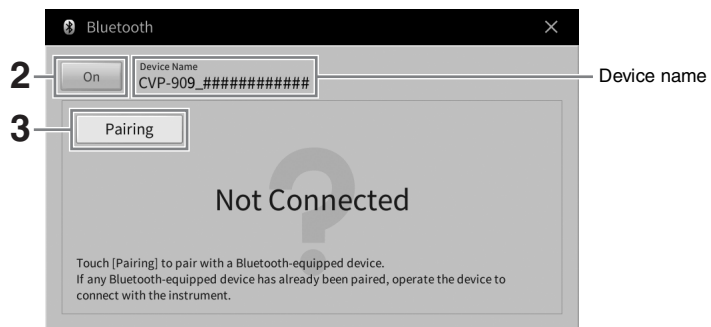

2 Make sure that the Bluetooth function is set to “On.”

3 Touch [Pairing] to pair with a Bluetooth-equipped device.

If you wish to connect your Bluetooth-equipped device to the instrument, the device needs to be paired with the instrument first. Once the device has been paired with this instrument, there is no need to perform pairing again.

NOTE

- “Pairing” means to register Bluetooth-equipped devices on this instrument, and establish the mutual recognition for wireless communication between the two.
- Only one smart device can be connected to this instrument at a time (although up to 8 smart devices can be paired to this instrument). When pairing with the 9th smart device has succeeded, pairing data for the device with the oldest connection date will be deleted.
- Bluetooth headphones or speakers cannot be paired.

4 On the Bluetooth-equipped device, set the Bluetooth function to on and select this instrument (the device name is shown on the display in step 1) from the connection list.

After pairing is completed, the name of the Bluetooth-equipped device and “Connected” are shown in the display.

NOTE

If you are required to enter a passkey, enter the numerals “0000.”

5 Play back audio data on the Bluetooth-equipped device to confirm that the built-in speakers of the instrument can output the audio sound.

When you turn on the instrument the next time, the last-connected Bluetooth-equipped device will be connected to this instrument automatically, if the Bluetooth function of the Bluetooth-equipped device and the instrument is set to on. If it is not connected automatically, select this instrument from the connection list on the Bluetooth-equipped device.

About Bluetooth

Bluetooth is a technology for wireless communication between devices within an area of about 10 meters (33 ft.) employing the 2.4 GHz frequency band.

■ Handling Bluetooth communications

The 2.4 GHz band used by Bluetooth compatible devices is a radio band shared by many types of equipment. While Bluetooth compatible devices use a technology minimizing the influence of other components using the same radio band, such influence may reduce the speed or distance of communications and in some cases interrupt communications.

- The speed of signal transfer and the distance at which communication is possible differs according to the distance between the communicating devices, the presence of obstacles, radio wave conditions and the type of equipment.
- Yamaha does not guarantee all wireless connections between this unit and devices compatible with Bluetooth function.

Using an External Speaker System for Playback (AUX OUT [L/L+R]/[R] jacks)

You can connect a stereo system to amplify the instrument's sound by using the AUX OUT [L/L+R]/[R] jacks. The microphone or guitar sound connected to the instrument's [MIC/LINE IN] jack is output at the same time.

NOTICE

- To avoid possible damage, first turn on the power to the instrument, and then to the external device. When turning off the power, first turn off the power to the external device, and then to the instrument. Since this instrument's power may automatically be turned off due to the Auto Power Off function (page 19), turn off the power to the external device, or disable Auto Power Off when you do not intend to operate the instrument.
- Do not route the output from the AUX OUT jacks to the [AUX IN] jack. If you make this connection, the signal input at the [AUX IN] jack is output from the AUX OUT jacks. These connections could result in a feedback loop that will make normal performance impossible, and may even damage the equipment.

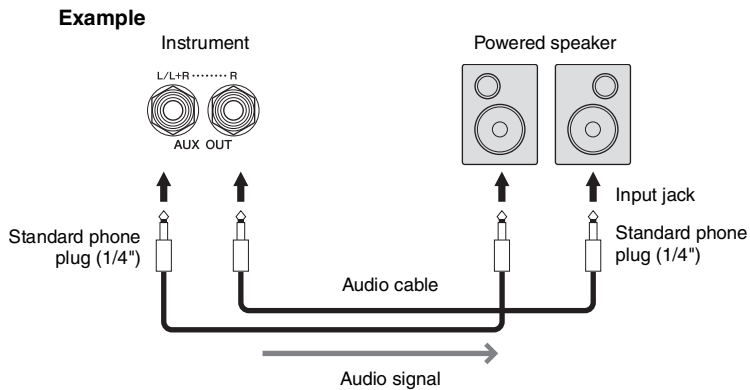

NOTE

- Use audio cables and adaptor plugs having no (zero) resistance.
- Use only the [L/L+R] jack for connection with a monaural device.
- Use an appropriate adaptor plug if the input jack of the powered speaker does not match the phone plug of the audio cable.
- When you are monitoring the sound output via the AUX OUT jacks from headphones connected to the instrument, we recommend that you set the Binaural Sampling and Stereophonic Optimizer functions to off. For details, refer to page 21.

Connecting External MIDI Devices (MIDI terminals)

By using MIDI cables and connecting to an external MIDI device (keyboard, sequencer, etc.) or a computer, you can control the MIDI device from the instrument or control the instrument from the MIDI device.

- **MIDI [IN]:** Receives MIDI messages from another MIDI device.
- **MIDI [OUT]:** Transmits MIDI messages generated by the instrument to another MIDI device.
- **MIDI [THRU]:** Simply relays the MIDI messages received at MIDI IN.

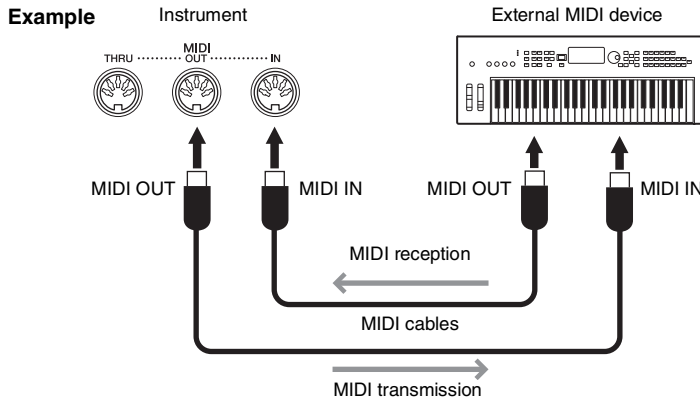

The MIDI settings such as transmit/receive channels on the instrument can be set via [Menu] → [MIDI]. For details, refer to the Reference Manual on the website (page 9).

NOTE

- For a general overview of MIDI and how you can effectively use it, refer to “MIDI Basics” on the website (page 9).
- For information on setting up your sequence software, refer to the owner’s manual of the relevant software.
- When transmitting MIDI data from this instrument to an external MIDI device, unexpected sounds may occur because of data related to the Grand Expression Modeling (page 53).

Viewing the Instrument’s Display on an External Monitor

By connecting with an external monitor such as a television, you can duplicate the instrument display (mirroring) or separately show the lyrics/text on an external monitor. Use a USB display adaptor and a display cable which are compatible with both this instrument and the monitor to connect to the [USB TO DEVICE] terminal of this instrument. For a list of compatible USB display adaptors, visit the following website:

<https://download.yamaha.com/>

NOTE

Before using the [USB TO DEVICE] terminal, be sure to read “Precautions when using the [USB TO DEVICE] terminal” on page 103.

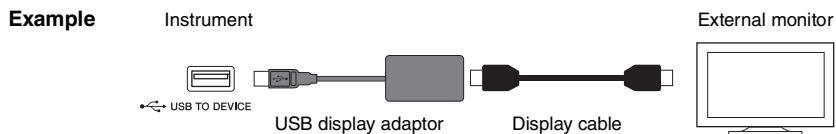

Set the display content that is to be output via [Menu] → [Utility] → [Speaker/Connectivity] → page 2/2.

Lyrics/Text	Only the lyrics of the Song or text files (whichever you used last time) are output, regardless of the display that is called up on the instrument.
Mirroring	The currently selected display is output.

Connecting a Microphone or Guitar ([MIC/LINE IN] jack)

To the [MIC/LINE IN] jack (standard 1/4" phone jack), you can connect a microphone, guitar, or other various equipment. For instructions on connecting a microphone, refer to page 86.

Note that you need to select "MIC" or "LINE IN" depending on the connected equipment. When the output level of the connected equipment (such as a microphone, guitar, bass) is low, set the [MIC/LINE] switch to "MIC." When the output level of the connected equipment (such as a synthesizer, keyboard, CD player) is high, set the [MIC/LINE] switch to "LINE."

Connecting a Footswitch/Foot Controller ([AUX PEDAL] jack)

The FC4A or FC5 footswitches and the FC7 foot controller (sold separately) can be connected to [AUX PEDAL] jack. A footswitch can be used for switching functions on and off, while a foot controller controls continuous parameters such as volume.

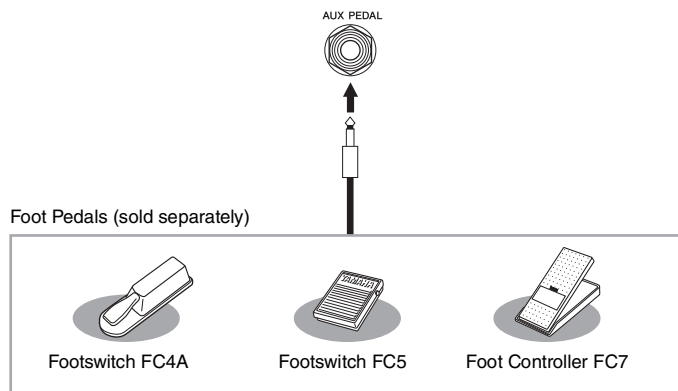

■ Example 1: Using a foot controller to control the volume of the performance data played on the keyboard.

Connect an FC7 foot controller to the [AUX PEDAL] jack. With the initial factory settings, no special setup is necessary.

■ Example 2: Using a footswitch to control Song Start/Stop.













Connect a footswitch (FC4A or FC5) to the [AUX PEDAL] jack. To assign the function to the connected pedal, select "Song Play/Pause" in the operation display: [Menu] → [Assignable] → [Pedal].





NOTE





- Make sure to connect or disconnect the pedal only when the power is off.
- Do not press the footswitch/foot pedal while turning the power on. Doing this changes the recognized polarity of the footswitch, resulting in reversed footswitch operation.

Menu Display Function List

This section explains simply and very briefly explains what you can do in the displays which are called up by touching each icon on the Menu display. Some functions are described in this Owner's Manual on the pages indicated below. For details about each function, refer to the Reference Manual on the website (page 9).

Menu		Description	Pages
	Tempo	For adjusting the tempo of MIDI Song, Style or Metronome. The same operation as using TEMPO [-]/[+] and [TAP TEMPO] buttons can be done on the display.	39
	Transpose	For transposing the pitch of the entire sound in semitones, or just the sound of the keyboard or MIDI Song.	41
	Split Point & Fingering Type	Lets you set the Split Point or change the Chord Fingering type and Chord Detection Area.	54, 65
	Chord Tutor	Shows you an example of how to play a chord that corresponds to the specified chord name.	-
	Balance	For adjusting the volume balance among the keyboard parts (Main, Layer, Left), Style, Song, and the sound input via the microphone, [AUX IN] jack, etc.	42
	Filter	For adjusting the Harmonic Content (resonance) and sound brightness.	98
	EQ	For adjusting equalization parameters to correct the tone or timbre of the sound.	
	Effect	For selecting an Effect type and adjusts its depth for each part.	
	Chorus/Reverb	For selecting a Chorus/Reverb type and adjusts its depth for each part.	
	Pan/Volume	For adjusting panning and volume for each part.	
	(Master) Compressor	Lets you turn on/off the Master Compressor, and edit related parameters.	
	(Master) EQ	For editing the Master EQ.	
	Score	For displaying the music notation (score) of the current MIDI Song.	70
	Lyrics	For displaying the lyrics of the current MIDI Song.	71
	Text Viewer	For displaying text files created on your computer.	-
	Keyboard Harmony	For adding the Harmony effect to the right-hand section of the keyboard. Parameters such as Harmony type can be set.	-
	Mic Setting	Makes settings for the microphone sound.	-
	Vocal Harmony	For adding Vocal Harmony effects to your singing. You can edit the Vocal Harmony and save as your original harmony.	87
	Playlist	For creating your own repertoire list in which the links to the Registration Memory Bank file for each performance are registered. You can conveniently select just the panel settings you want (as a Record) for your performance from the huge number of Registration Memory Bank files.	89
	Registration Sequence	Determines the order for calling up Registration Memory settings when using the pedal or ASSIGNABLE button.	-
	Registration Freeze	Determines the item(s) to be unchanged even when you call up panel setups from the Registration Memory.	-

Menu		Description	Pages	
	Chord Looper	By recording chord progressions you play, the Style can be played back automatically in response to the chord progression data—without the need for you to play chords in the chord section of the keyboard.	–	
	Assignable	Pedal	Determines the functions assigned to the pedals.	–
		Assignable	Determines the functions assigned to the ASSIGNABLE [1] – [4] buttons.	31
	Voice Edit	Lets you edit the preset Voices to create your own Voices. The display differs depending on whether an Organ Flutes Voice or another kind of Voice is selected.	56	
	Style Creator	Lets you create a Style by editing the preset Style, or by recording Style channels one by one.	–	
	Song Creator	Lets you create a Song by “writing” it down one event at a time, or by editing an existing recorded Song.	–	
	Voice Setting	Tune	For adjusting the pitch for each keyboard part (Main/Layer/Left).	–
		Piano	For editing the parameters of the piano Voices, including VRM and Grand Expression Modeling.	
		Each Key Setting	For adjusting the pitch or the volume of each note (or key) individually for the Main part's Voice.	
		Voice Set	Determines which settings (effects, etc.) linked to the Voices are not called up when selecting a Voice.	
		Other Setting	Determines how the Voice Selection display is opened when one of the VOICE category buttons is pressed. Also determines whether to add articulation effects or not when selecting an S.Art2 Voice (CVP-909 only).	
	Style Setting	Setting	For editing parameters for Style playback such as Stop ACMP (Stop Accompaniment) and OTS Link Timing.	–
		Change Behavior	Determines the Style condition (sections, tempo, etc.) when selecting a different Style.	
	Song Setting	Guide	For selecting the type of the Guide function, or changes the guide lamp settings.	–
		Part Ch	Determines which MIDI channel in the Song data is used for the right-hand/left-hand part.	
		Lyrics	Determines the language of the displayed lyrics.	
		Play	For editing parameters for Song playback such as Repeat Playback and the Performance Assistant Technology.	
		Rec	For editing parameters for re-recording of MIDI Songs, or setting the file format for Audio recording.	
	Tuning	Master Tune	For fine-tuning the pitch of the entire instrument in approx. 0.2 Hz steps.	–
		Scale Tune	For selecting the scale type and tuning the pitch of the desired note (key) in cents.	
	Keyboard Setting	Determines the Touch Response of the keyboard, or turns the Left Hold function on/off.	40, 52	
	Metronome Setting	Metronome	Determines the metronome volume, sound and time signature.	–
		Tap Tempo	Determines the volume and sound type of the sound caused when the [TAP TEMPO] button is pressed.	
	MIDI Setting	System	For editing the parameters for MIDI system messages.	–
		Transmit	For editing the parameters for MIDI transmission.	
		Receive	For editing the parameters for MIDI reception.	
		On Bass Note	Determines the bass note for Style playback based on the note messages received via MIDI.	
		Chord Detect	Determines the chord type for Style playback based on the note messages received via MIDI.	

Menu		Description	Pages
 Utility	Speaker/Connectivity	For making the settings for the instrument's speakers and the external monitor.	111
	Touch Screen/Display	For editing the parameters for the display settings, such as the theme of the home display, brightness, and touch panel calibration.	23
	Parameter Lock	Determines which parameters (effect, Split Point, etc.) will not be changed when the panel setups are changed via Registration Memory.	–
	Storage	Indicates the capacity of the User memory and the connected USB flash drive or allows you to format it.	104
	System	Indicates the firmware version of this instrument, and lets you make basic settings, such as the language for the display and voice guide.	22
	Factory Reset/Backup	For initializing the instrument to the factory default, or backing up the data stored in the instrument.	43
 Bluetooth^{*1}	For connecting to a Bluetooth-equipped device.	108	
 Wireless LAN Settings^{*2}	For making settings for connecting the instrument to a smart device, such as a smartphone or tablet, via a USB wireless LAN adaptor.	–	
 Time^{*2}	For making settings of the time shown on the display.	–	

*1 This icon appears only if the instrument is equipped with Bluetooth functionality. Depending on the country in which you purchased it, Bluetooth may not be available.

*2 These icons appear only when the USB wireless LAN adaptor (UD-WL01; sold separately) has been connected once.

CVP-909 (Grand piano type) Assembly

⚠ CAUTION

- Assemble the unit on a hard and flat floor with ample space.
- Be careful not to confuse or misplace the parts, and be sure to install all parts in the correct orientation. Please assemble the unit in accordance with the sequence described here.
- Assembly should be carried out by at least four persons.
- Be sure to use only the included screws of the specified sizes. Do not use any other screws. Use of incorrect screws can cause damage or malfunction of the product.
- Be sure to tighten all screws upon completing assembly of each unit.
- To disassemble the unit, reverse the assembly sequence.

Have a Phillips-head (+) screwdriver of the appropriate size ready.



Remove all parts from the package and make sure you have all of the items.

To prevent the key cover from accidentally opening during assembly, press down on the key cover, making sure that the sheets (shown) remain in place.

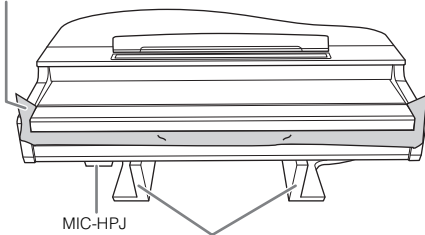

MIC-HPJ

To prevent damage to the MIC-HPJ unit located at the bottom of main unit, make sure to place main unit on the styrofoam pads. Also, make sure that the pads do not touch the MIC-HPJ.

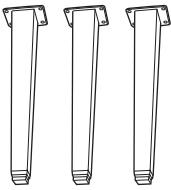

Legs

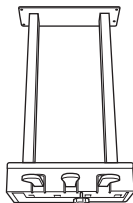

Pedal box

Bundled pedal cord inside. The pedals are protected with vinyl covers when shipped from the factory. Remove the covers from the pedals before using to ensure optimum use of the pedal effects.

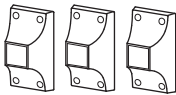

Leg beams

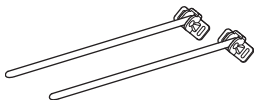

Lyre braces

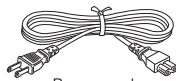

Power cord



6 x 40 mm fixing screws x 12



Cord holder



6 x 20 mm fixing screws x 4



4 x 10 mm thin screws x 12



4 x 16 mm thin screws x 4

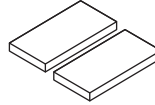

Protective pads x 2



Headphone hanger



4 x 10 mm thin screws x 2

1 Lean the main unit against the wall as shown.

- 1 Spread a large soft cloth, such as a blanket, as shown to protect the floor and wall surfaces.
- 2 Lean the main unit against the wall with the key cover closed and the keyboard side on the bottom.

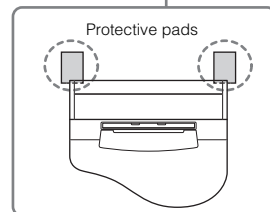
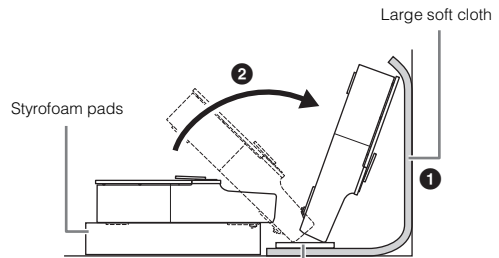

⚠ CAUTION

Be careful not to pinch your fingers.

NOTICE

Do not place the main unit as shown in the illustration here.

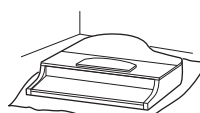

Incorrect

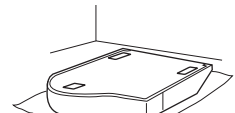

Incorrect

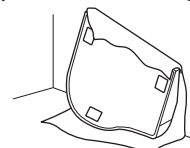

Incorrect

2 Attach the three legs and three leg beams.

Refer to the diagram below to verify the orientation of the legs.

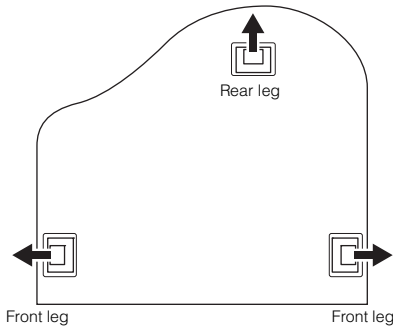

- 1 Install and tighten four screws on each leg, starting with one of the front legs.

6 x 40 mm fixing screws

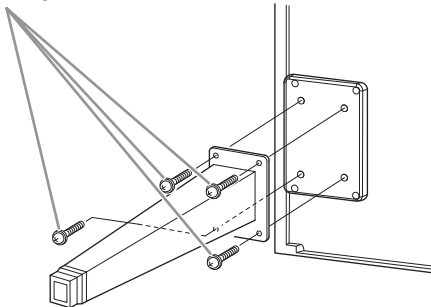

- 2 Slide the leg beams over the legs, and attach them to each of the legs using four thin screws (4 x 10 mm). Make sure that the gradually inclined side of the leg beams faces the inside of the unit as shown.

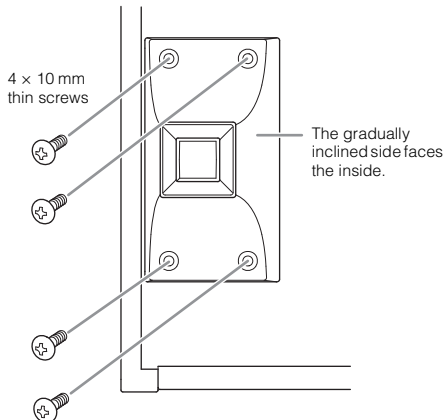

3 Attach the lyre braces.

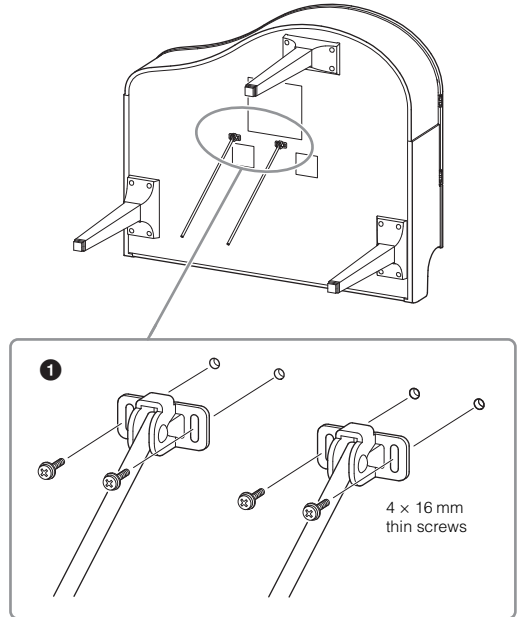

- 1 Attach the lyre braces using the four thin screws (4 x 16 mm).

4 Raise the unit to the standing position.

Use the front legs as support to raise the unit.

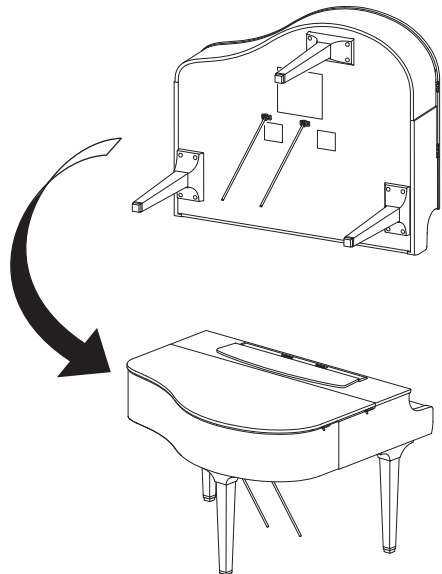

5 Install the pedal box.

- 1 Remove the twist tie and tape that affix the pedal cord to the upper portion of the pedal box.

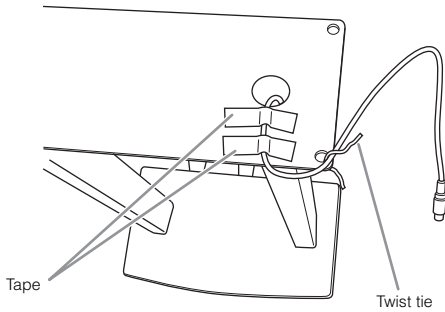

- 2 Attach the front side of the pedal box to the bottom of the unit by finger-tightening the two fixing screws (6 x 20 mm).

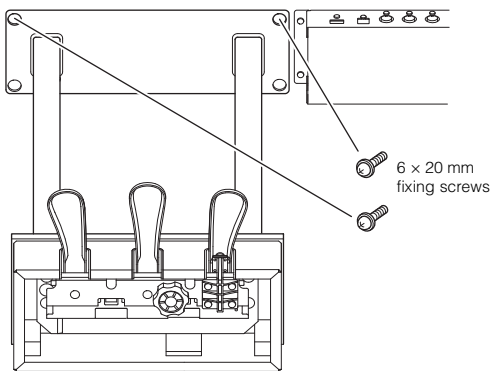

- 3 Insert the lyre braces into the pedal box recesses and make sure they fit securely.

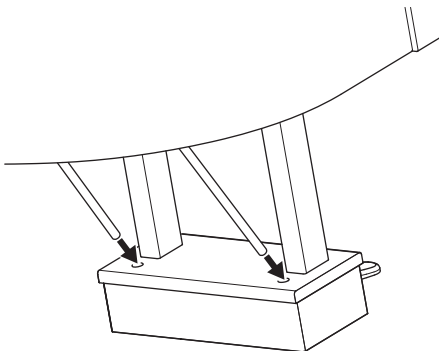

- 4 Align the cord with the groove on the unit and attach the backside of the pedal box using the two fixing screws (6 x 20 mm), and then securely tighten the two screws of the front side of the pedal box that were attached in step 5-2.

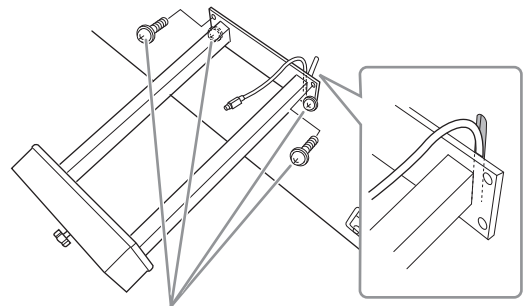

6 x 20 mm fixing screws

- 5 Loosen the four screws that were attached in step 3, and then securely tighten the four screws again while pushing the lyre braces in the direction of arrows as illustrated.

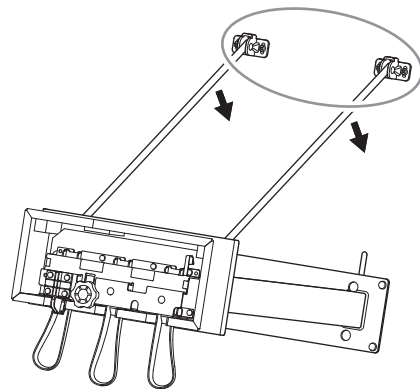

- 6 Insert the pedal cord plug into the pedal connector. Insert the plug so the arrow side faces front (toward the keyboard). If the plug will not go in easily, do not force it. Double-check the orientation of the plug, then try again.

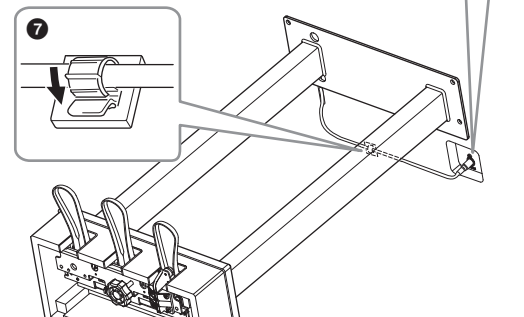
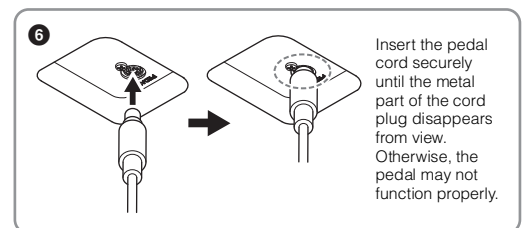

- 7 Attach the cord holder to the bottom of the main unit as shown, then clip the holder around the cord.

6 Rotate the adjuster until it comes in firm contact with the floor surface.

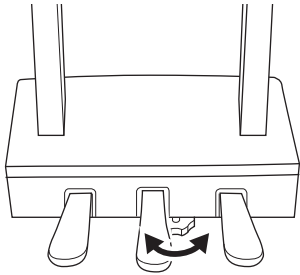

7 Plug the power cord into the [AC IN] jack.

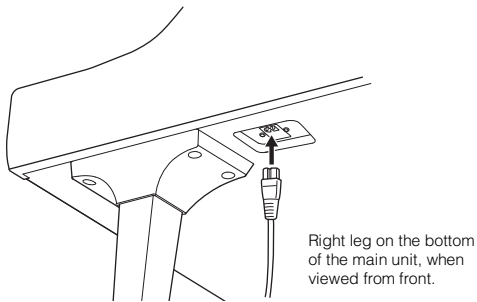

8 Attach the headphone hanger.
Attach the headphone hanger using two thin screws (4 × 10 mm) as shown in the illustration.

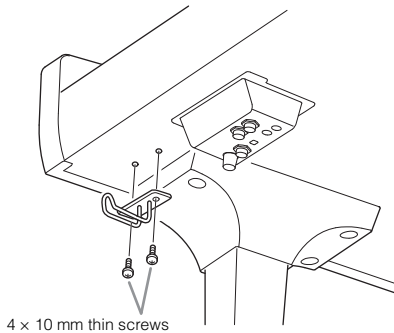

CAUTION

To disassemble the unit, reverse the assembly sequence. Failure to do so can result in damage to the instrument or personal injury. In particular, if you lay down the main unit without detaching the pedal box, the pedals will break.

After completing the assembly, please check the following.

- **Are there any parts left over?**
→ Review the assembly procedure and correct any errors.
- **Is the instrument clear of doors and other movable fixtures?**
→ Move the instrument to an appropriate location.
- **Does the instrument make a rattling noise when you shake it?**
→ Tighten all screws.
- **Does the pedal box rattle or give way when you step on the pedals?**
→ Turn the adjuster so that it is set firmly against the floor.
- **Are the pedal and power cords inserted securely into the sockets?**

Transporting

CAUTION

When moving the instrument, always hold the bottom of the main unit. Do not hold the key cover or top portion. Improper handling can result in damage to the instrument or personal injury.

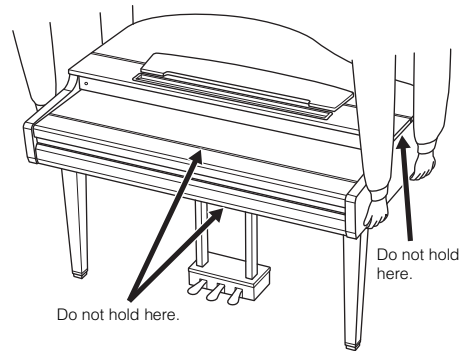

If you move to another location, you can transport the instrument along with other belongings. You can move the unit as it is (assembled) or you can disassemble the unit down to the condition it was in when you first took it out of the box. Transport the keyboard horizontally. Do not lean it up against a wall or stand it up on its side. Do not subject the instrument to excessive vibration or shock. When transporting the assembled instrument, make sure all screws are properly tightened and have not been loosened by moving the instrument.

CAUTION

If the unit creaks or is otherwise unsteady when you play on the keyboard, refer to the assembly diagrams and retighten all screws.

CVP-909 Assembly

⚠ CAUTION

- Assemble the unit on a hard and flat floor with ample space.
- Be careful not to confuse or misplace the parts, and be sure to install all parts in the correct orientation. Please assemble the unit in accordance with the sequence described here.
- Assembly should be carried out by at least two persons.
- Be sure to use only the included screws of the specified sizes. Do not use any other screws. Use of incorrect screws can cause damage or malfunction of the product.
- Be sure to tighten all screws upon completing assembly of each unit.
- To disassemble the unit, reverse the assembly sequence.

Have a Phillips-head (+) screwdriver of the appropriate size ready.

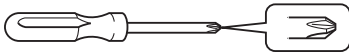

Remove all parts from the package and make sure you have all of the items.

To prevent the key cover from accidentally opening during assembly, press down on the key cover, making sure that the sheets (shown) remain in place.

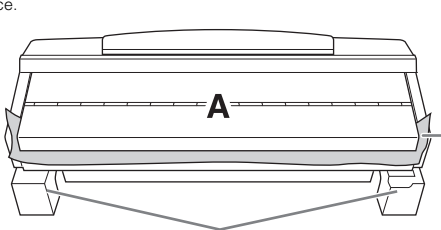

To prevent damage to the speaker box located at the bottom of unit A, make sure to place unit A on the styrofoam pads. Also, make sure that the pads do not touch the speaker box.

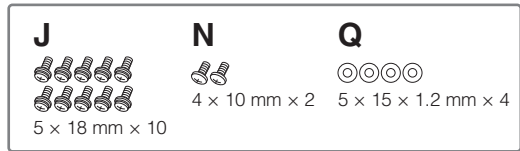
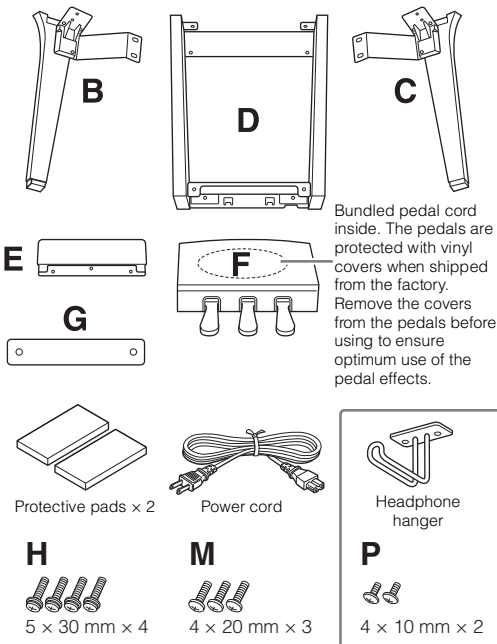

1 Lean unit A against the wall as shown.

- 1 Spread a large soft cloth, such as a blanket, as shown to protect the floor and wall surfaces.
- 2 Lean unit A against the wall with the key cover closed and the keyboard side on the bottom.

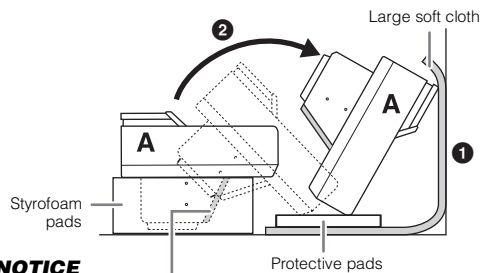

NOTICE

Do not touch the speaker net. Doing so may damage the speaker inside.

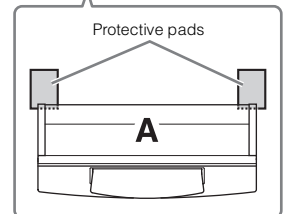

⚠ CAUTION

Be careful not to pinch your fingers.

NOTICE

- The top part of the music rest is not fixed. Support the music rest with your hand so that the music rest will not fall.
- Do not place the main unit upside down or with the rear side facing down.

2 Attach units B and C to unit A.

- 1 Align units B and A so that the protrusion fits into the hole.

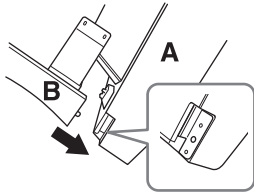

- 2 Fix unit B to the bottom surface of unit A using two screws H.

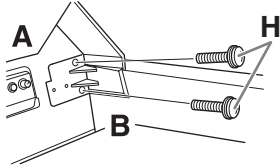

Attach the parts, pressing unit B onto unit A so that the two fit tightly together.

- 3 Fix unit B to the speaker box of unit A using two screws J.

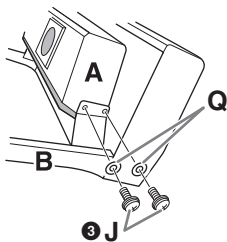

If the screw holes do not align, loosen the other screws and adjust the position of unit B.

- 4 Fasten unit C to unit A in the same way.

3 Attach unit E to unit D.

Fix unit E to unit D using two screws J.

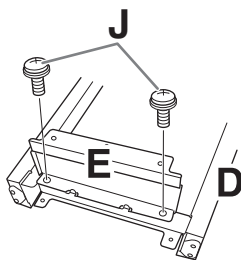

4 Attach unit D to unit A.

- 1 Fix unit D to the bottom surface of unit A using two screws J.

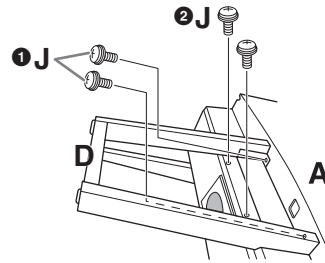

- 2 Fix unit D to the speaker box of unit A using two screws J.

If the screw holes do not align, loosen the other screws and adjust the position of unit D.

5 Raise unit A into the upright position.

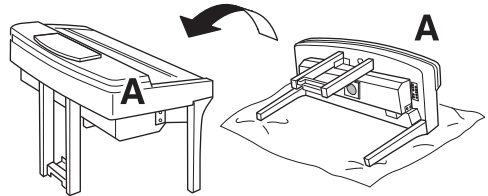

CAUTION

- Be careful not to pinch your fingers.
- When you raise the unit, do not hold the key cover.

6 Install unit F.

- 1 Remove the cover from unit D.

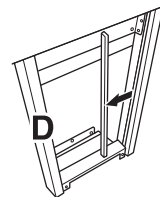

- 2 Untie and straighten out the bundled cord.

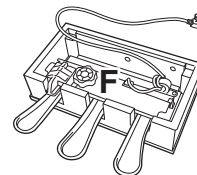

- 3 Pass the pedal cord from under unit D to the backside of the main unit.

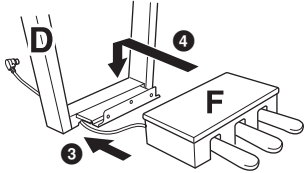

- 4 Place unit F on the bracket of unit D.
5 Attach unit F to unit D using three screws M.

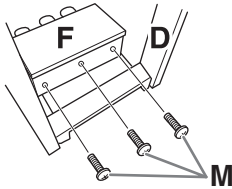

7 Connect the pedal cord.

1 Insert the pedal cord plug into the pedal connector. Insert the pedal cord securely until the metal part of the cord plug disappears from view. Otherwise, the pedal may not function properly.

2 Pass the pedal cord between units D and E.

3 Align the pedal cord into the groove on unit D, then install the cover onto the groove correctly.

- 4 Attach unit G using two screws N.

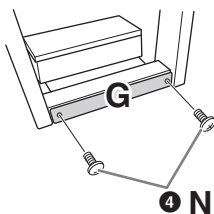

- 8 Insert the AC power cord plug into the [AC IN] jack.

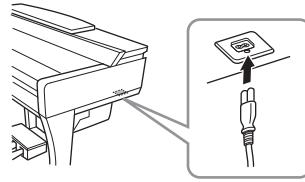

- 9 Rotate the adjuster until it comes in firm contact with the floor surface.

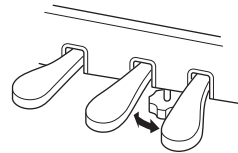

- 10 Attach the headphone hanger.

Attach the headphone hanger using two screws P as shown in the illustration.

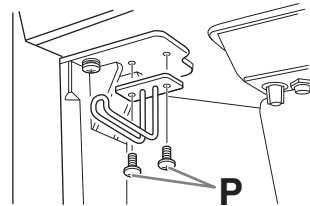

After completing the assembly, please check the following.

- **Are there any parts left over?**
→ Review the assembly procedure and correct any errors.
- **Is the instrument clear of doors and other movable fixtures?**
→ Move the instrument to an appropriate location.
- **Does the instrument make a rattling noise when you shake it?**
→ Tighten all screws.
- **Does the pedal box rattle or give way when you step on the pedals?**
→ Turn the adjuster so that it is set firmly against the floor.
- **Are the pedal and power cords inserted securely into the sockets?**

Transporting

CAUTION

When moving the instrument, always hold the bottom of the main unit. Do not hold the key cover or top portion. Improper handling can result in damage to the instrument or personal injury.

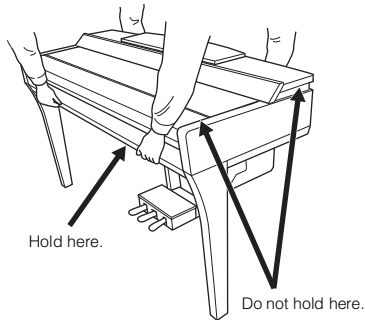

If you move to another location, you can transport the instrument along with other belongings. You can move the unit as it is (assembled) or you can disassemble the unit down to the condition it was in when you first took it out of the box. Transport the keyboard horizontally. Do not lean it up against a wall or stand it up on its side. Do not subject the instrument to excessive vibration or shock. When transporting the assembled instrument, make sure all screws are properly tightened and have not been loosened by moving the instrument.

CAUTION

If the unit creaks or is otherwise unsteady when you play on the keyboard, refer to the assembly diagrams and retighten all screws.

CVP-905 Assembly

⚠ CAUTION

- Assemble the unit on a hard and flat floor with ample space.
- Be careful not to confuse or misplace the parts, and be sure to install all parts in the correct orientation. Please assemble the unit in accordance with the sequence described here.
- Assembly should be carried out by at least two persons.
- Be sure to use only the included screws of the specified sizes. Do not use any other screws. Use of incorrect screws can cause damage or malfunction of the product.
- Be sure to tighten all screws upon completing assembly of each unit.
- To disassemble the unit, reverse the assembly sequence.

Have a Phillips-head (+) screwdriver of the appropriate size ready.



Remove all parts from the package and make sure you have all of the items.

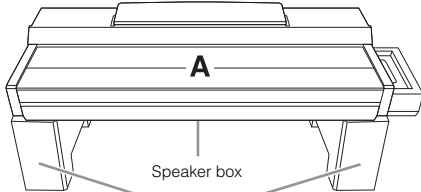

Remove foamed styrol pads from the package, position them on the floor, then place A on top of them. Position the pads so that they will not block the speaker box on the bottom of A.

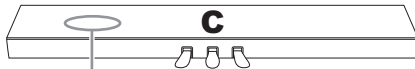

Bundled pedal cord inside here.

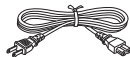
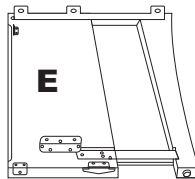
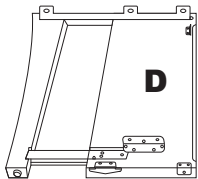

Power cord



Cord holders x 2



Headphone hanger

1 Attach C to D and E.

- 1 Place C, D and E as shown in the illustration.
- 2 Untie and straighten out the bundled pedal cord. Do not discard the vinyl tie. You will need the vinyl tie later in step 5.
- 3 Secure D and E to C using four screws F. Press D and E toward C while securing.

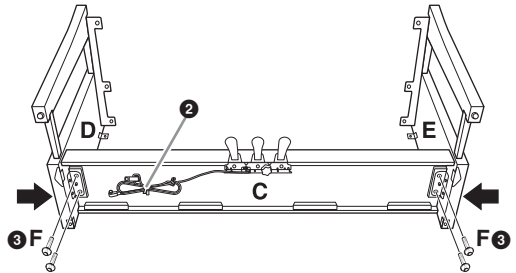

2 Attach B.

- 1 Align the holes on the upper side of B with the bracket holes on D and E, then attach the upper corners of B to D and E by finger-tightening two screws G. These screws will be securely tightened in step 4-3.
- 2 Secure the bottom end of B using four screws H.

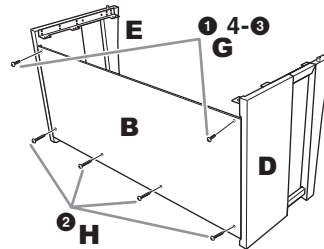

3 Mount A.

Be sure to place your hands at least 15 cm from either end of A when positioning it. The projections on top of D and E should be inserted to the holes on the bottom of A.

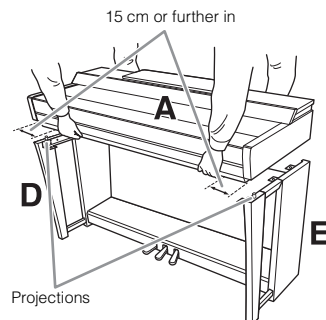

⚠ CAUTION

- Be extra careful not to drop the unit or let your fingers be pinched by the main unit.
- Do not hold the main unit in any position other than the position specified here.

4 Secure A.

- Adjust the position of A so that the inner lines of the side boards of A and D/E are aligned as shown in the illustration.
- Attach A using six screws F.
- Securely tighten the screws G on the top of B that were attached in step 2-1.

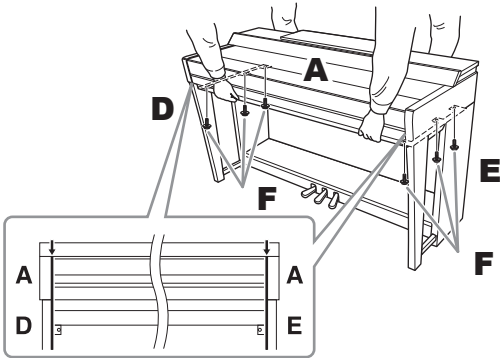

5 Connect the pedal cord and power cord.

- Insert the pedal cord plug into the pedal connector. Insert the pedal cord securely until the metal part of the cord plug disappears from view. Otherwise, the pedal may not function properly.
- Attach the cord holders to the rear panel as shown, then clip the cord into the holders.
- Use a vinyl tie to take up any slack in the pedal cord.
- Insert the AC power cord plug into the [AC IN] jack.

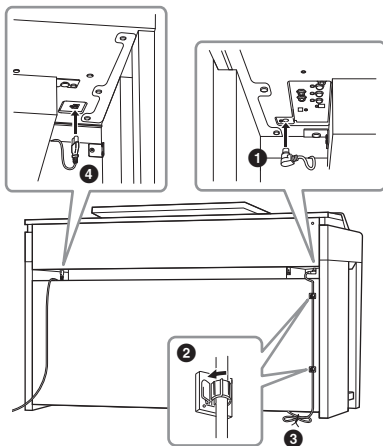
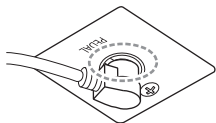

6 Rotate the adjuster until it comes in firm contact with the floor surface.

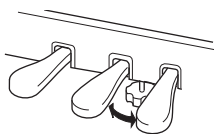

7 Attach the headphone hanger.

Attach the headphone hanger using two screws J as shown in the illustration.

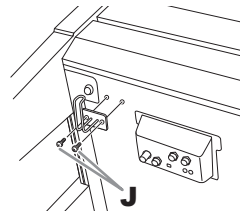

After completing the assembly, please check the following.

- Are there any parts left over?**
→ Review the assembly procedure and correct any errors.
- Is the instrument clear of doors and other movable fixtures?**
→ Move the instrument to an appropriate location.
- Does the instrument make a rattling noise when you shake it?**
→ Tighten all screws.
- Does the pedal box rattle or give way when you step on the pedals?**
→ Turn the adjuster so that it is set firmly against the floor.
- Are the pedal and power cords inserted securely into the sockets?**

Transporting

⚠ CAUTION

When moving the instrument, always hold the bottom of the main unit. Do not hold the key cover or top portion. Improper handling can result in damage to the instrument or personal injury.

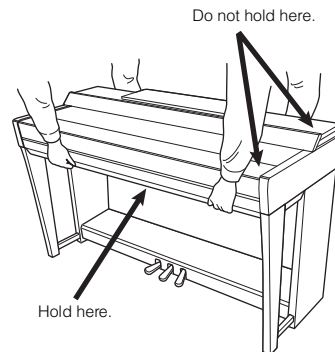

If you move to another location, you can transport the instrument along with other belongings. You can move the unit as it is (assembled) or you can disassemble the unit down to the condition it was in when you first took it out of the box. Transport the keyboard horizontally. Do not lean it up against a wall or stand it up on its side. Do not subject the instrument to excessive vibration or shock. When transporting the assembled instrument, make sure all screws are properly tightened and have not been loosened by moving the instrument.

⚠ CAUTION

If the unit creaks or is otherwise unsteady when you play on the keyboard, refer to the assembly diagrams and retighten all screws.

Troubleshooting

Overall	
A click or pop is heard when the power is turned on or off.	Electrical current is being applied to the instrument. This is normal.
The power is automatically turned off.	This is normal and due to the Auto Power Off function. If necessary, set the parameter of the Auto Power Off function (page 19).
Noise is heard from the instrument's speakers.	Noise may be heard if a mobile phone is used near the instrument or if the phone is ringing. Turn off the mobile phone, or use it further away from the instrument.
Noise is heard from the instrument's speakers or headphones when using the instrument with the app on the smart device such as smartphone or tablet.	When you use the instrument along with the app on your smart device, we recommend that you enable "Airplane Mode" on the device to avoid noise caused by communication. When wirelessly connecting a smart device with this product, make sure that the Wi-Fi or Bluetooth setting on the device is turned on.
In the LCD, there are some specific points that are always lit or unlit.	These are the result of defective pixels and occasionally occur in TFT-LCDs; they do not indicate a problem in operation.
Mechanical noise is heard during performance.	The keyboard mechanism of this instrument simulates the keyboard mechanism of an actual piano. Mechanical noise is also heard on a piano.
There is a slight difference in sound quality among different notes played on the keyboard.	This is normal and is a result of the instrument's sampling system.
Some Voices have a looping sound.	
Some noise or vibrato is noticeable at higher pitches, depending upon the Voice.	
The overall volume is too low or no sound is heard.	
	The master volume may be set too low. Set it to an appropriate level with the [MASTER VOLUME] control (page 20).
	All keyboard parts are set to off. On the Home display, touch [Main]/[Layer]/[Left] to turn on the part (page 49).
	The volume of the individual parts may be set too low. Raise the volume in the Balance display (page 42).
	Make sure the desired channel is set to on (page 100).
	Make sure a pair of headphones or an adapter plug is not connected to the [PHONES] jack.
	Make sure that the "Speaker" is set to "On" from [Menu] → [Utility] → [Speaker/Connectivity].
The sound is distorted or noisy.	The volume may be turned up too high. Make sure all relevant volume settings are appropriate.
	This may be caused by certain effects or filter resonance settings. Check the effect or filter settings and change them accordingly in the Mixer display, referring to the Reference Manual on the website (page 9).
Not all simultaneously played notes sound, or the sound of Style or Song seems to be cut off.	You are probably exceeding the maximum polyphony (page 130) of the instrument. When the maximum polyphony is exceeded, the earliest played notes will stop sounding, letting the latest played notes sound.
The keyboard volume is lower than the Song/Style playback volume.	The volume of the keyboard parts may be set too low. Raise the keyboard volume (Main/Layer/Left), or lower the Song/Style volume in the Balance display (page 42).
Some characters of the file/folder name are garbled.	The language settings have been changed. Set the appropriate language for the file/folder name (page 22).

Overall	
An existing file is not shown on the display.	The file extension (.MID, etc.) may have been changed or deleted. Manually rename the file on a computer, adding the appropriate extension.
	Data files with names of more than 50 characters cannot be handled by the instrument. Rename the file, reducing the number of characters to 50 or less.
Metronome, MIDI Song or Style goes out of tempo slightly when you play the keyboard.	This occurs infrequently when Grand Expression Modeling is set to "Dynamic." If this happens, set Grand Expression Modeling to "Static" via [Menu] → [Voice Setting] → [Piano].

Voice	
The Voice selected from the Voice Selection display does not sound.	Check whether or not the selected part is turned on (page 49).
A strange "flanging" or "doubling" sound occurs. The sound is slightly different each time the keys are played.	The Main and Layer parts are set to on, and both parts are set to play the same Voice. Turn off the Layer part or change the Voice of one of the parts.
Some Voices will jump an octave in pitch when played in the upper or lower registers.	This is normal. Some Voices have a pitch limit which, when reached, causes this type of pitch shift.
No sound is heard or sound is strange in the left-hand section.	If the "Stop ACMP" parameter is set to something other than "Disabled" via [Menu] → [StyleSetting] → [Setting], the Voice on the chord section does not sound normally when the [ACMP ON/OFF] button is on. Set the "Stop ACMP" parameter to "Disabled" or turn the [ACMP ON/OFF] button off. For details about the Stop ACMP function, refer to the Reference Manual on the website (page 9).

Style	
The Style does not start even when the [START/STOP] button is pressed.	The Rhythm channel of the selected Style may not contain any data. Turn the [ACMP ON/OFF] button on and play in the left-hand section on the keyboard to sound the accompaniment part of the Style.
Only the rhythm channel plays; accompaniment sounds are not heard.	Make sure the Auto Accompaniment function is turned on; press the [ACMP ON/OFF] button.
	Make sure to play keys in the chord section of the keyboard (page 59).
Styles in a USB flash drive cannot be selected.	If the size of the Style data is large (about 120 KB or greater), the Style cannot be selected because the data is too large to be read by the instrument.

Song	
Songs cannot be selected.	This may be because the language settings have been changed. Set the appropriate language for the Song file name (page 22).
	If the size of the Song data is large (about 3 MB or greater), the Song cannot be selected because the data is too large to be read by the instrument.
	The file format is not supported. Refer to page 67 for details on supported Song formats.
Song playback does not start.	The Song has been stopped at the end of the Song data. Return to the beginning of the Song by pressing the SONG CONTROL [■] (Stop) button.
(MIDI) Song playback stops before the Song is finished.	The Guide function is turned on. (In this case, playback is "waiting" for the correct key to be played.) Turn off the Guide function (page 72).

Song	
(MIDI) The measure number is different from that of the score in the Song Position display, shown by pressing the [◀◀] (Rewind)/[▶▶] (Fast forward) buttons.	This happens when playing back music data for which a specific, fixed tempo is set.
(MIDI) When playing back a Song, some channels do not play.	Playback of these channels may be set to off. Turn playback on for those channels that are set to off (page 100).
The guide lamps do not light during Song playback, even after turning on the Guide function.	The Guide function can be used only when a MIDI Song is played back. It is not available for Audio Songs.
	Any notes outside of the 88-key range cannot be indicated by the guide lamps.
	When the [ACMP ON/OFF] button is turned on, the guide lamps for the left-hand part do not work. As necessary, turn off the [ACMP ON/OFF] button when using it.
(MIDI) The guide lamps light an octave or two lower/higher than the actual pitch.	The guide lamps sometimes light an octave or two lower/higher than the actual pitch depending on the selected Voice.
(MIDI) The tempo, beat, measure and music notation is not displayed correctly.	Some Song data for the instrument has been recorded with special “free tempo” settings. For such Song data, the tempo, beat, measure and music notation will not be displayed correctly.
(MIDI) When viewing the lyrics on the Score display, some lyrics are omitted and cannot be seen.	There is not enough space to show the lyrics. Change the size of the Score to other than “Medium” via the View Setting (page 71).
A message indicating the USB flash drive is unavailable appears, and the recording is aborted.	Make sure to use a compatible USB flash drive (page 103).
	Make sure that the USB flash drive has enough memory (page 104).
	If you are using a USB flash drive to which data has already been recorded, check first that no important data remains on the device, and then format it (page 104) and try recording again.
The Song playback volume differs depending on the selected Song.	The volume of MIDI Songs and Audio Songs are set independently. Adjust the volume in the Balance display (page 42) after selecting a Voice.

Microphone	
The microphone input signal cannot be recorded.	The microphone input signal cannot be recorded by MIDI Recording. Record by using Audio recording (page 76).
Harmony can be heard in addition to the microphone sound.	Vocal Harmony is set to “On.” Turn Vocal Harmony off (page 87).
The Vocal Harmony effect sounds distorted or out-of-tune.	Your vocal microphone may be picking up extraneous sounds, such as the Style sound from the instrument. In particular, bass sounds can cause mistracking of Vocal Harmony. To remedy this: <ul style="list-style-type: none"> • Sing as closely to the microphone as possible. • Use a unidirectional microphone. • Turn down the Master volume, or adjust the volume balance on the Balance display (page 42).
The Vocal Harmony effect is not applied even when it is turned on.	In the Chordal mode, Vocal Harmony is added only when chords are detected. Try one of the following: <ul style="list-style-type: none"> • Turn on the [ACMP ON/OFF] button and play chords in the chord section during Style playback. • Turn on the Left part and play chords in the left hand section. • Play back a Song which contains chords. • Set the “Stop ACMP” parameter to something other than “Disabled” via [Menu] → [StyleSetting] → [Setting]. For details, refer to the Reference Manual on the website (page 9).

Mixer	
The sound seems strange or different than expected when changing a rhythm Voice (drum kit, etc.) of the Style or Song from the Mixer.	When changing the rhythm/percussion Voices (drum kits, etc.) of the Style and Song from the VOICE parameter, the detailed settings related to the drum voice are reset, and in some cases you may be unable to restore the original sound. You can restore the original sound by selecting the same Song or Style again.

Pedal/AUX Pedal	
The damper, sostenuto and soft functions do not work for the relevant pedals.	The pedal cord plug is not connected to the pedal jack securely. Securely insert the pedal cord plug into the proper jack (pages 118, 122, 125).
	Make sure that each pedal is properly assigned to “Sustain,” “Sostenuto” and “Soft” (page 38).
The on/off setting of the footswitch/foot controller connected to the [AUX PEDAL] jack is reversed.	Turn the instrument’s power off, and then turn it on again without pressing the footswitch/foot controller, or change the Polarity parameter from [Menu] → [Assignable] → [Pedal].
The damper pedal does not function properly.	The power of the instrument may have been turned on while the damper pedal was pressed. Press and release the damper pedal to restore proper operation.

Connection	
The speakers do not switch off when a pair of headphones is connected to the [PHONES] jack.	The Speaker setting is “On.” Set the speaker setting to “Headphone Switch” via [Menu] → [Utility] → [Speaker/Connectivity].
The Wireless LAN icon is not shown in the Menu display even though the USB wireless LAN adaptor is connected.	Disconnect the USB wireless LAN adaptor and connect it again.
The Bluetooth-equipped device cannot be paired with nor connected to the instrument.	Check the Bluetooth function of the Bluetooth-equipped device is activated. To connect the Bluetooth-equipped device and the instrument, Bluetooth function of both devices need to be turned on.
	The Bluetooth-equipped device and the instrument need to be paired to connect each other via Bluetooth (page 108).
	In case there is a device (microwave oven, wireless LAN device, etc.) that outputs signals in the 2.4 GHz frequency band nearby, move this instrument away from the device that is emitting radio-frequency signals.
Sound input to the [AUX IN] jack is interrupted.	The output volume of the external device connected to the [AUX IN] jack of this instrument is too low. Increase the output volume of the external device. The volume level reproduced via this instrument’s speakers can be adjusted by using the [MASTER VOLUME] control. The Noise Gate function may be cutting the soft sounds. If this happens, turn off the “AUX IN Noise Gate” parameter (page 107).

Specifications

		CVP-909GP (Grand Piano type)	CVP-909	CVP-905	
Product Name		Digital Piano			
Size/Weight	Width [For models with polished finish]	[1,430 mm (56-5/16")]	1,426 mm (56-1/8") [1,429 mm (56-1/4")]	1,420 mm (55-15/16") [1,423 mm (56-0")]	
	Height [For models with polished finish]	With music rest closed	[913 mm (35-15/16")]	868 mm (34-3/16") [872 mm (34-5/16")]	868 mm (34-3/16") [871 mm (34-5/16")]
		With music rest raised	[1,076 mm (42-3/8")]	1,027 mm (40-7/16") [1,028 mm (40-1/2")]	1,026 mm (40-3/8") [1,027 mm (40-7/16")]
		With lid up	[1,554 mm (61-3/16")]	-	
	Depth [For models with polished finish]	[1,236 mm (48-11/16")]	612 mm (24-1/8") [612 mm (24-1/8")]	592 mm (23-5/16") [593 mm (23-3/8")]	
	Weight [For models with polished finish]	[130 kg (286 lb, 10 oz)]	82 kg (180 lb, 12 oz) [85 kg (187 lb, 6 oz)]	82 kg (180 lb, 12 oz) [84 kg (185 lb, 3 oz)]	
Control Interface	Keyboard	Number of Keys	88		
		Type	GrandTouch Keyboard: wooden keys (white only), synthetic ebony and ivory key tops, escapement		
		88-key Linear Graded Hammers	Yes		
		Counter Weight	Yes	-	
		Touch Response	Hard2/Hard1/Medium/Soft1/Soft2		
	Pedal	Number of Pedals	3: Damper (with Half-pedal function), Sostenuto, Soft		
		GrandTouch Pedals	Yes (with GP Response Damper)	Yes	
		Assignable Functions	Sustain, Sostenuto, Soft, Glide, Song Play/Pause, Style Start/Stop, Volume, etc.		
	Display	Type	TFT Color LCD (Touch Screen)		
		Size	800 x 480 dots 9.0 inch	800 x 480 dots 7.0 inch	
		Score/Lyrics/Text Display Function	Yes		
		Language	English, German, French, Spanish, Italian, Japanese		
	Panel	Language	English		
Cabinet	Key Cover Style	Folding			
	Music Rest	Yes (with music braces)			
Voices	Tone Generation	Piano Sound	Yamaha CFX, Bösendorfer Imperial		
		Binaural Sampling	Yes ("CFX Concert Grand" and "Bösendorfer Grand" Voice only)		
	Piano Effects	VRM	Yes		
		Grand Expression Modeling	Yes		
		Key-off Samples	Yes		
		Smooth Release	Yes		
	Polyphony (max.)	256			
	Preset	Number of Voices	1,605 Voices + 58 Drum/SFX Kits + 480 XG Voices	1,315 Voices + 49 Drum/SFX Kits + 480 XG Voices	
		Number of VRM Voices	17	14	
		Number of Super Articulation Voices	S.Art2: 36, S.Art: 301	S.Art: 227	
	Custom	Voice Edit	Yes		
Compatibility	XG, GS (for Song playback), GM, GM2				
Other Features	Mono/Poly	Yes			

		CVP-909GP (Grand Piano type)	CVP-909	CVP-905
Effects	Types	Reverb	65 Preset + 30 User	
		Chorus	107 Preset + 30 User	106 Preset + 30 User
		Insertion Effect	358 Preset + 30 User	322 Preset + 30 User
		Variation Effect	358 Preset + 30 User	322 Preset + 30 User
		Master Compressor	5 Preset + 30 User	
		Master EQ	5 Preset + 30 User	
		Part EQ	27 Parts	
		Vocal Harmony	54 Preset + 60 User	
		Intelligent Acoustic Control (IAC)	Yes	
		Stereophonic Optimizer	Yes	
	Functions	Dual (Layer)	Yes	
Split		Yes		
Styles	Preset	Number of Styles	675	525
		Fingering Types	Single Finger, Fingered, Fingered On Bass, Multi Finger, AI Fingered, Full Keyboard, AI Full Keyboard	
		Style Control	INTRO × 3, MAIN VARIATION × 4, FILL × 4, BREAK, ENDING × 3	
	Custom	Style Creator	Yes	
	Other Features	One Touch Setting (OTS)	4 for each Style	
		Chord Looper	Yes	
Compatibility		Style File Format (SFF), Style File Format GE (SFF GE)		
Songs (MIDI)	Preset	Number of Preset Songs	50 Classics + 303 Lesson Songs + 60 Popular	
	Recording	Number of Tracks	16	
		Data Capacity	approx. 3 MB/Song	
		Song Creator	Yes	
	Format	Playback	SMF (Format 0, Format 1), XF	
Recording		SMF (Format 0)		
Songs (Audio)	Recording Time (max.)		80 minutes/Song	
	Format	Playback	WAV (44.1kHz, 16bit, stereo), MP3 (MPEG-1 Audio Layer-3)	
		Recording	WAV (44.1kHz, 16bit, stereo), MP3 (MPEG-1 Audio Layer-3)	
	Functions	Time Stretch, Pitch Shift, Vocal Cancel	Yes	
Functions	Registration Memory	Number of Buttons	8	
		Control	Registration Sequence, Freeze	
	Playlist	Number of Records (max.)	2,500	
	Lesson/Guide		Follow Lights, Any Key, Karao-Key, Your Tempo (with guide lamps)	
	Overall Controls	Metronome	Yes	
		Tempo Range	5 – 500, Tap Tempo	
		Transpose	–12 – 0 – +12	
		Tuning	414.8 – 440 – 466.8 Hz (approx. 0.2 Hz increments)	
Scale Type		9 Types		

		CVP-909GP (Grand Piano type)	CVP-909	CVP-905
Functions	Bluetooth (May not have this functionality depending on the country in which you purchased the product.)	Bluetooth version	4.2	
		Supported profile	A2DP	
		Compatible codec	SBC	
		Wireless output	Bluetooth class 2	
		Maximum communication distance	Approx. 10 m	
		Radio Frequency	2,401 – 2,481 MHz	
		Maximum output power (EIRP)	4 dBm	
		Type of modulation	FHSS	
	Miscellaneous	Piano Room	Yes	
		Display output to an external monitor	Yes (by using a commercially available USB display adaptor*) * For a list of compatible devices, access the "Yamaha Downloads" website.	
		Brightness Adjustment	Yes (display/button lamps)	
USB audio interface		44.1 kHz, 24 bit, stereo		
Storage and Connectivity	Storage	Internal Memory	approx. 2 GB	
		External Drives	USB flash drive	
	Connectivity	Headphones	Standard stereo phone jack (× 2)	
		Microphone	Mic/Line in (standard mono phone jack), Input volume	
		MIDI	IN, OUT, THRU	
		AUX IN	Stereo mini jack	
		AUX OUT	L/L+R, R	
		AUX PEDAL	Yes	
		USB TO DEVICE	Yes (× 2)	
USB TO HOST	Yes			
Sound System	Amplifiers	(40W + 30W + 20W) × 2 + 80W	(45 W + 20 W) × 2	
	Speakers	(16 cm + 5 cm + 2.5 cm (dome)) × 2 + 20 cm, Spruce Cone Speaker, Twisted Flare Port	(16 cm + 2.5 cm (dome)) × 2	
Power Supply	Auto Power Off	Yes		
Included Accessories		Owner's Manual, Music Book, Online Member Product Registration, Power cord, Bench* * May not be included depending on your area. Check with your Yamaha dealer.		
Separately Sold Accessories (May not be available depending on your area.)		Headphones (HPH-150/HPH-100/HPH-50), Footswitches (FC4A/FC5), Foot controller (FC7), USB wireless LAN adaptor (UD-WL01)		

The contents of this manual apply to the latest specifications as of the publishing date. To obtain the latest manual, access the Yamaha website then download the manual file. Since specifications, equipment or separately sold accessories may not be the same in every locale, please check with your Yamaha dealer.

Index

A

A-B Repeat	73
Accessories	9
ACMP ON/OFF button	61
AI Fingered	66
AI Full Keyboard	66
Assembly	116, 120, 124
ASSIGNABLE buttons	31
Audio conversion	85
Audio Input Sound	107
Audio Loopback	105
Audio recording	76
Audio Song	67
Auto Accompaniment	58
Auto Power Off	19
AUX IN	107

B

Backup	43
Balance	42
Bank	91
Binaural Sampling	21
Bluetooth Audio	108
Break	62
Brightness	23

C

Channel	82, 100
Character entry	36
Chord	66
Chord Looper	62
Chord section	59
Chordal	87
Chorus	99
Compressor	99
Computer	105
Connection	101
Copy	34
Copyright	22

D

Damper Pedal	38
Data dial	30
Delete	34
Demo	13
Display	26

E

Edit (Song)	78, 99
Effect	99
Ending section	61
EQ	99

F

Factory Reset	42
Fast Forward	69
Favorite	35
File	32
File Selection display	27
Fill-in	62
Filter	99
Fingered	65
Fingered On Bass	65
Fingering type	65
Fixed Velocity	40
Folder	33
Foot Controller	112
Footswitch	112
Force-quit	19
Format	8, 104
Full Keyboard	65

G

GP Response Damper	38
Grand Expression Modeling	53
Guide	72

H

Half-pedal	38
Headphones	20
Home display	26

I

IAC (Intelligent Acoustic Control)	20
Initialize (Factory Reset)	42
Intro section	61

K

Karaoke	88
Key cover	16

L

Language	22
Layer part	49
Left Hold	52
Left part	49
Left Split Point	54
Lid	17
Lyrics	71

M

Main part	49
Main section	62
Master Compressor	99
Master volume	20
Menu area	26
Menu display	28, 113

Metronome	39
Microphone	86
MIDI connection	111
MIDI Recording	76
MIDI Song	67
Mixer	98
Monitor	111
Move	34
MP3	76
Multi channel recording	82
Multi Finger	65
Music notation	70
Music rest	16

N

Noise Gate	107
------------------	-----

O

One Touch Setting	63
Organ Flutes Voice	56
OTS	63
Owner Name	22

P

Pairing	109
Pan	99
Pause	69
Pedal	38, 112
Piano Lock	52
Piano Reset	52
Piano Room	44
Pitch	41
Pitch Shift	74
Playback (Song)	67
Playback (Style)	61
Playlist	89
Power	18

R

Record	94
Recording (Piano Room)	48
Recording (Song)	76
Reference Manual	9
Registration area	26
Registration Memory	89
Rename	33
Repeat	73
Restore	42
Reverb	99
Rewind	69
Rotary Speaker	57

S

S.Art/S.Art2 Voice	55
Save	32
Score	70
Search	36
Single Finger	65
Soft Pedal	38
Song	67

Song area	26
Sostenuto Pedal	38
Speed (Tempo)	75
Split Point	54
Stereophonic Optimizer	21
Style	58
Style area	26
Style Split Point	54
Super Articulation Voice	55
Syncho Start (MIDI Song)	70
Syncho Start (Style)	61
Syncho Stop	61

T

Tag	93
Talk	88
Tempo	39
Text	71
Time Stretch	75
Touch Curve	40
Touch Response	40
Touch screen	29
Touch Sensitivity	40
Transpose	41
Troubleshooting	126
Tuning	41

U

USB Audio Interface	105
USB flash drive	103
USB TO DEVICE	103
USB TO HOST	105
USB wireless LAN adaptor	106
User data	27

V

Version	22
Vocal Cancel	75
Vocal Harmony	87
Vocoder	87
Vocoder-Mono	87
Voice	49
Voice area	26
Volume	20
Volume (Song)	42
Volume (Style)	42
Volume Balance	42
VRM	53

W

WAV	76
-----------	----

MEMO

GNU GENERAL PUBLIC LICENSE

Version 2, June 1991

Copyright © 1989, 1991 Free Software Foundation, Inc., 51 Franklin Street, Fifth Floor, Boston, MA 02110-1301 USA
Everyone is permitted to copy and distribute verbatim copies of this license document, but changing it is not allowed.

Preamble

The licenses for most software are designed to take away your freedom to share and change it. By contrast, the GNU General Public License is intended to guarantee your freedom to share and change free software—to make sure the software is free for all its users. This General Public License applies to most of the Free Software Foundation's software and to any other program whose authors commit to using it. (Some other Free Software Foundation software is covered by the GNU Lesser General Public License instead.) You can apply it to your programs, too.

When we speak of free software, we are referring to freedom, not price. Our General Public Licenses are designed to make sure that you have the freedom to distribute copies of free software (and charge for this service if you wish), that you receive source code or can get it if you want it, that you can change the software or use pieces of it in new free programs; and that you know you can do these things.

To protect your rights, we need to make restrictions that forbid anyone to deny you these rights or to ask you to surrender the rights. These restrictions translate to certain responsibilities for you if you distribute copies of the software, or if you modify it.

For example, if you distribute copies of such a program, whether gratis or for a fee, you must give the recipients all the rights that you have. You must make sure that they, too, receive or can get the source code. And you must show them these terms so they know their rights.

We protect your rights with two steps: (1) copyright the software, and (2) offer you this license which gives you legal permission to copy, distribute and/or modify the software.

Also, for each author's protection and ours, we want to make certain that everyone understands that there is no warranty for this free software. If the software is modified by someone else and passed on, we want its recipients to know that what they have is not the original, so that any problems introduced by others will not reflect on the original authors' reputations.

Finally, any free program is threatened constantly by software patents. We wish to avoid the danger that redistributors of a free program will individually obtain patent licenses, in effect making the program proprietary. To prevent this, we have made it clear that any patent must be licensed for everyone's free use or not licensed at all.

The precise terms and conditions for copying, distribution and modification follow.

GNU GENERAL PUBLIC LICENSE TERMS AND CONDITIONS FOR COPYING, DISTRIBUTION AND MODIFICATION

0. This License applies to any program or other work which contains a notice placed by the copyright holder saying it may be distributed under the terms of this General Public License. The "Program" below, refers to any such program or work, and a "work based on the Program" means either the Program or any derivative work under copyright law: that is to say, a work containing the Program or a portion of it, either verbatim or with modifications and/or translated into another language. (Hereinafter, translation is included without limitation in the term "modification.") Each licensee is addressed as "you".

Activities other than copying, distribution and modification are not covered by this License; they are outside its scope. The act of running the Program is not restricted, and the output from the Program is covered only if its contents constitute a work based on the Program (independent of having been made by running the Program). Whether that is true depends on what the Program does.

1. You may copy and distribute verbatim copies of the Program's source code as you receive it, in any medium, provided that you conspicuously and appropriately publish on each copy an appropriate copyright notice and disclaimer of warranty; keep intact all the notices that refer to this License and to the absence of any warranty; and give any other recipients of the Program a copy of this License along with the Program.

You may charge a fee for the physical act of transferring a copy, and you may at your option offer warranty protection in exchange for a fee.

2. You may modify your copy or copies of the Program or any portion of it, thus forming a work based on the Program, and copy and distribute such modifications or work under the terms of Section 1 above, provided that you also meet all of these conditions:

a) You must cause the modified files to carry prominent notices stating that you changed the files and the date of any change.

b) You must cause any work that you distribute or publish, that in whole or in part contains or is derived from the Program or any part thereof, to be licensed as a whole at no charge to all third parties under the terms of this License.

c) If the modified program normally reads commands interactively when run, you must cause it, when started running for such interactive use in the most ordinary way, to print or display an announcement including an appropriate copyright notice and a notice that there is no warranty (or else, saying that you provide a warranty) and that users may redistribute the program under these conditions, and telling the user how to view a copy of this License. (Exception: if the Program itself is interactive but does not normally print such an announcement, your work based on the Program is not required to print an announcement.)

These requirements apply to the modified work as a whole. If identifiable sections of that work are not derived from the Program, and can be reasonably considered independent and separate works in themselves, then this License, and its terms, do not apply to those sections when you distribute them as separate works. But when you distribute the same sections as part of a whole which is a work based on the Program, the distribution of the whole must be on the terms of this License, whose permissions for other licensees extend to the entire whole, and thus to each and every part regardless of who wrote it.

Thus, it is not the intent of this section to claim rights or contest your rights to work written entirely by you; rather, the intent is to exercise the right to control the distribution of derivative or collective works based on the Program.

In addition, mere aggregation of another work not based on the Program with the Program (or with a work based on the Program) on a volume of a storage or distribution medium does not bring the other work under the scope of this License.

3. You may copy and distribute the Program (or a work based on it, under Section 2) in object code or executable form under the terms of Sections 1 and 2 above provided that you also do one of the following:

a) Accompany it with the complete corresponding machine-readable source code, which must be distributed under the terms of Sections 1 and 2 above on a medium customarily used for software interchange; or,

b) Accompany it with a written offer, valid for at least three years, to give any third party, for a charge no more than your cost of physically performing source distribution, a complete machine-readable copy of the corresponding source code, to be distributed under the terms of Sections 1 and 2 above on a medium customarily used for software interchange; or,

c) Accompany it with the information you received as to the offer to distribute corresponding source code. (This alternative is allowed only for noncommercial distribution and only if you received the program in object code or executable form with such an offer, in accord with Subsection b above.)

The source code for a work means the preferred form of the work for making modifications to it. For an executable work, complete source code means all the source code for all modules it contains, plus any associated interface definition files, plus the scripts used to control compilation and installation of the executable. However, as a special exception, the source code distributed need not include anything that is normally distributed (in either source or binary form) with the major components (compiler, kernel, and so on) of the operating system on which the executable runs, unless that component itself accompanies the executable.

If distribution of executable or object code is made by offering access to copy from a designated place, then offering equivalent access to copy the source code from the same place counts as distribution of the source code, even though third parties are not compelled to copy the source code along with the object code.

4. You may not copy, modify, sublicense, or distribute the Program except as expressly provided under this License. Any attempt otherwise to copy, modify, sublicense or distribute the Program is void, and will automatically terminate your rights under this License. However, parties who have received copies, or rights, from you under this License will not have their licenses terminated so long as such parties remain in full compliance.

5. You are not required to accept this License, since you have not signed it. However, nothing else grants you permission to modify or distribute the Program or its derivative works. These actions are prohibited by law if you do not accept this License. Therefore, by modifying or distributing the Program (or any work based on the Program), you indicate your acceptance of this License to do so, and all its terms and conditions for copying, distributing or modifying the Program or works based on it.

6. Each time you redistribute the Program (or any work based on the Program), the recipient automatically receives a license from the original licensor to copy, distribute or modify the Program subject to these terms and conditions. You may not impose any further restrictions on the recipients' exercise of the rights granted herein. You are not responsible for enforcing compliance by third parties to this License.
7. If, as a consequence of a court judgment or allegation of patent infringement or for any other reason (not limited to patent issues), conditions are imposed on you (whether by court order, agreement or otherwise) that contradict the conditions of this License, they do not excuse you from the conditions of this License. If you cannot distribute so as to satisfy simultaneously your obligations under this License and any other pertinent obligations, then as a consequence you may not distribute the Program at all. For example, if a patent license would not permit royalty-free redistribution of the Program by all those who receive copies directly or indirectly through you, then the only way you could satisfy both it and this License would be to refrain entirely from distribution of the Program.

If any portion of this section is held invalid or unenforceable under any particular circumstance, the balance of the section is intended to apply and the section as a whole is intended to apply in other circumstances.

It is not the purpose of this section to induce you to infringe any patents or other property right claims or to contest validity of any such claims; this section has the sole purpose of protecting the integrity of the free software distribution system, which is implemented by public license practices. Many people have made generous contributions to the wide range of software distributed through that system in reliance on consistent application of that system; it is up to the author/donor to decide if he or she is willing to distribute software through any other system and a licensee cannot impose that choice.

This section is intended to make thoroughly clear what is believed to be a consequence of the rest of this License.
8. If the distribution and/or use of the Program is restricted in certain countries either by patents or by copyrighted interfaces, the original copyright holder who places the Program under this License may add an explicit geographical distribution limitation excluding those countries, so that distribution is permitted only in or among countries not thus excluded. In such case, this License incorporates the limitation as if written in the body of this License.
9. The Free Software Foundation may publish revised and/or new versions of the General Public License from time to time. Such new versions will be similar in spirit to the present version, but may differ in detail to address new problems or concerns.
10. Each version is given a distinguishing version number. If the Program specifies a version number of this License which applies to it and "any later version", you have the option of following the terms and conditions either of that version or of any later version published by the Free Software Foundation. If the Program does not specify a version number of this License, you may choose any version ever published by the Free Software Foundation.
11. If you wish to incorporate parts of the Program into other free programs whose distribution conditions are different, write to the author to ask for permission. For software which is copyrighted by the Free Software Foundation, write to the Free Software Foundation; we sometimes make exceptions for this. Our decision will be guided by the two goals of preserving the free status of all derivatives of our free software and of promoting the sharing and reuse of software generally.

NO WARRANTY

12. BECAUSE THE PROGRAM IS LICENSED FREE OF CHARGE, THERE IS NO WARRANTY FOR THE PROGRAM, TO THE EXTENT PERMITTED BY APPLICABLE LAW. EXCEPT WHEN OTHERWISE STATED IN WRITING THE COPYRIGHT HOLDERS AND/OR OTHER PARTIES PROVIDE THE PROGRAM "AS IS" WITHOUT WARRANTY OF ANY KIND, EITHER EXPRESSED OR IMPLIED, INCLUDING, BUT NOT LIMITED TO, THE IMPLIED WARRANTIES OF MERCHANTABILITY AND FITNESS FOR A PARTICULAR PURPOSE. THE ENTIRE RISK AS TO THE QUALITY AND PERFORMANCE OF THE PROGRAM IS WITH YOU. SHOULD THE PROGRAM PROVE DEFECTIVE, YOU ASSUME THE COST OF ALL NECESSARY SERVICING, REPAIR OR CORRECTION.
13. IN NO EVENT UNLESS REQUIRED BY APPLICABLE LAW OR AGREED TO IN WRITING WILL ANY COPYRIGHT HOLDER, OR ANY OTHER PARTY WHO MAY MODIFY AND/OR REDISTRIBUTE THE PROGRAM AS PERMITTED ABOVE, BE LIABLE TO YOU FOR DAMAGES, INCLUDING ANY GENERAL, SPECIAL, INCIDENTAL OR CONSEQUENTIAL DAMAGES ARISING OUT OF THE USE OR INABILITY TO USE THE PROGRAM (INCLUDING BUT NOT LIMITED TO LOSS OF DATA OR DATA BEING RENDERED INACCURATE OR LOSSES SUSTAINED BY YOU OR THIRD PARTIES OR A FAILURE OF THE PROGRAM TO OPERATE WITH ANY OTHER PROGRAMS), EVEN IF SUCH HOLDER OR OTHER PARTY HAS BEEN ADVISED OF THE POSSIBILITY OF SUCH DAMAGES.

END OF TERMS AND CONDITIONS

How to Apply These Terms to Your New Programs

If you develop a new program, and you want it to be of the greatest possible use to the public, the best way to achieve this is to make it free software which everyone can redistribute and change under these terms.

To do so, attach the following notices to the program. It is safest to attach them to the start of each source file to most effectively convey the exclusion of warranty; and each file should have at least the "copyright" line and a pointer to where the full notice is found.

```
<one line to give the program's name and a brief idea of what it does.>
Copyright © <year> <name of author>
```

```
This program is free software; you can redistribute it and/or modify it
under the terms of the GNU General Public License as published by the
Free Software Foundation; either version 2 of the License, or (at your
option) any later version.
```

```
This program is distributed in the hope that it will be useful, but WITHOUT
ANY WARRANTY; without even the implied warranty of
MERCHANTABILITY or FITNESS FOR A PARTICULAR PURPOSE.
See the GNU General Public License for more details.
```

```
You should have received a copy of the GNU General Public License
along with this program; if not, write to the Free Software Foundation,
Inc., 51 Franklin Street, Fifth Floor, Boston, MA 02110-1301 USA.
```

Also add information on how to contact you by electronic and paper mail.

If the program is interactive, make it output a short notice like this when it starts in an interactive mode:

```
Gnomovision version 69, Copyright © year name of author
Gnomovision comes with ABSOLUTELY NO WARRANTY; for details
type 'show w'. This is free software, and you are welcome to redistribute it
under certain conditions; type 'show c' for details.
```

The hypothetical commands 'show w' and 'show c' should show the appropriate parts of the General Public License. Of course, the commands you use may be called something other than 'show w' and 'show c'; they could even be mouse-clicks or menu items—whatever suits your program.

You should also get your employer (if you work as a programmer) or your school, if any, to sign a "copyright disclaimer" for the program, if necessary. Here is a sample; alter the names:

```
Yoyodyne, Inc., hereby disclaims all copyright interest in the program
'Gnomovision' (which makes passes at compilers) written by James
Hacker.
```

```
<signature of Ty Coon>, 1 April 1989
Ty Coon, President of Vice
```

This General Public License does not permit incorporating your program into proprietary programs. If your program is a subroutine library, you may consider it more useful to permit linking proprietary applications with the library. If this is what you want to do, use the GNU Lesser General Public License instead of this License.

GNU LESSER GENERAL PUBLIC LICENSE

Version 2.1, February 1999

Copyright © 1991, 1999 Free Software Foundation, Inc., 51 Franklin Street, Fifth Floor, Boston, MA 02110-1301 USA
Everyone is permitted to copy and distribute verbatim copies of this license document, but changing it is not allowed.

[This is the first released version of the Lesser GPL. It also counts as the successor of the GNU Library Public License, version 2, hence the version number 2.1.]

Preamble

The licenses for most software are designed to take away your freedom to share and change it. By contrast, the GNU General Public Licenses are intended to guarantee your freedom to share and change free software—to make sure the software is free for all its users.

This license, the Lesser General Public License, applies to some specially designated software packages—typically libraries—of the Free Software Foundation and other authors who decide to use it. You can use it too, but we suggest you first think carefully about whether this license or the ordinary General Public License is the better strategy to use in any particular case, based on the explanations below.

When we speak of free software, we are referring to freedom of use, not price. Our General Public Licenses are designed to make sure that you have the freedom to distribute copies of free software (and charge for this service if you wish); that you receive source code or can get it if you want it; that you can change the software and use pieces of it in new free programs; and that you are informed that you can do these things.

To protect your rights, we need to make restrictions that forbid distributors to deny you these rights or to ask you to surrender these rights. These restrictions translate to certain responsibilities for you if you distribute copies of the library or if you modify it.

For example, if you distribute copies of the library, whether gratis or for a fee, you must give the recipients all the rights that we gave you. You must make sure that they, too, receive or can get the source code. If you link other code with the library, you must provide complete object files to the recipients, so that they can relink them with the library after making changes to the library and recompiling it. And you must show them these terms so they know their rights.

We protect your rights with a two-step method: (1) we copyright the library, and (2) we offer you this license, which gives you legal permission to copy, distribute and/or modify the library.

To protect each distributor, we want to make it very clear that there is no warranty for the free library. Also, if the library is modified by someone else and passed on, the recipients should know that what they have is not the original version, so that the original author's reputation will not be affected by problems that might be introduced by others.

Finally, software patents pose a constant threat to the existence of any free program. We wish to make sure that a company cannot effectively restrict the users of a free program by obtaining a restrictive license from a patent holder. Therefore, we insist that any patent license obtained for a version of the library must be consistent with the full freedom of use specified in this license.

Most GNU software, including some libraries, is covered by the ordinary GNU General Public License. This license, the GNU Lesser General Public License, applies to certain designated libraries, and is quite different from the ordinary General Public License. We use this license for certain libraries in order to permit linking those libraries into non-free programs.

When a program is linked with a library, whether statically or using a shared library, the combination of the two is legally speaking a combined work, a derivative of the original library. The ordinary General Public License therefore permits such linking only if the entire combination fits its criteria of freedom. The Lesser General Public License permits more lax criteria for linking other code with the library.

We call this license the "Lesser" General Public License because it does Less to protect the user's freedom than the ordinary General Public License. It also provides other free software developers Less of an advantage over competing non-free programs. These disadvantages are the reason we use the ordinary General Public License for many libraries. However, the Lesser license provides advantages in certain special circumstances.

For example, on rare occasions, there may be a special need to encourage the widest possible use of a certain library, so that it becomes a de-facto standard. To achieve this, non-free programs must be allowed to use the library. A more frequent case is that a free library does the same job as widely used non-free libraries. In this case, there is little to gain by freeing the library to free software only, so we use the Lesser General Public License.

In other cases, permission to use a particular library in non-free programs enables a greater number of people to use a large body of free software. For example, permission to use the GNU C Library in non-free programs enables many more people to use the whole GNU operating system, as well as its variant, the GNU/Linux operating system.

Although the Lesser General Public License is Less protective of the users' freedom, it does ensure that the user of a program that is linked with the Library has the freedom and the wherewithal to run that program using a modified version of the Library.

The precise terms and conditions for copying, distribution and modification follow. Pay close attention to the difference between a "work based on the library" and a "work that uses the library". The former contains code derived from the library, whereas the latter must be combined with the library in order to run.

GNU LESSER GENERAL PUBLIC LICENSE TERMS AND CONDITIONS FOR COPYING, DISTRIBUTION AND MODIFICATION

0. This License Agreement applies to any software library or other program which contains a notice placed by the copyright holder or other authorized party saying it may be distributed under the terms of this Lesser General Public License (also called "this License"). Each licensee is addressed as "you".

A "library" means a collection of software functions and/or data prepared so as to be conveniently linked with application programs (which use some of those functions and data) to form executables.

The "Library" below, refers to any such software library or work which has been distributed under these terms. A "work based on the Library" means either the Library or any derivative work under copyright law: that is to say, a work containing the Library or a portion of it, either verbatim or with modifications and/or translated straightforwardly into another language. (Hereinafter, translation is included without limitation in the term "modification".)

"Source code" for a work means the preferred form of the work for making modifications to it. For a library, complete source code means all the source code for all modules it contains, plus any associated interface definition files, plus the scripts used to control compilation and installation of the library.

Activities other than copying, distribution and modification are not covered by this License; they are outside its scope. The act of running a program using the Library is not restricted, and output from such a program is covered only if its contents constitute a work based on the Library (independent of the use of the Library in a tool for writing it). Whether that is true depends on what the Library does and what the program that uses the Library does.

1. You may copy and distribute verbatim copies of the Library's complete source code as you receive it, in any medium, provided that you conspicuously and appropriately publish on each copy an appropriate copyright notice and disclaimer of warranty; keep intact all the notices that refer to this License and to the absence of any warranty; and distribute a copy of this License along with the Library.

You may charge a fee for the physical act of transferring a copy, and you may at your option offer warranty protection in exchange for a fee.

2. You may modify your copy or copies of the Library or any portion of it, thus forming a work based on the Library, and copy and distribute such modifications or work under the terms of Section 1 above, provided that you also meet all of these conditions:

a) The modified work must itself be a software library.

b) You must cause the files modified to carry prominent notices stating that you changed the files and the date of any change.

c) You must cause the whole of the work to be licensed at no charge to all third parties under the terms of this License.

d) If a facility in the modified Library refers to a function or a table of data to be supplied by an application program that uses the facility, other than as an argument passed when the facility is invoked, then you must make a good faith effort to ensure that, in the event an application does not supply such function or table, the facility still operates, and performs whatever part of its purpose remains meaningful. (For example, a function in a library to compute square roots has a purpose that is entirely well-defined independent of the application. Therefore, Subsection 2d requires that any application-supplied function or table used by this function must be optional: if the application does not supply it, the square root function must still compute square roots.)

These requirements apply to the modified work as a whole. If identifiable sections of that work are not derived from the Library, and can be reasonably considered independent and separate works in themselves, then this License, and its terms, do not apply to those sections when you distribute them as separate works. But when you distribute the same

sections as part of a whole which is a work based on the Library, the distribution of the whole must be on the terms of this License, whose permissions for other licensees extend to the entire whole, and thus to each and every part regardless of who wrote it.

Thus, it is not the intent of this section to claim rights or contest your rights to work written entirely by you; rather, the intent is to exercise the right to control the distribution of derivative or collective works based on the Library.

In addition, mere aggregation of another work not based on the Library with the Library (or with a work based on the Library) on a volume of a storage or distribution medium does not bring the other work under the scope of this License.

3. You may opt to apply the terms of the ordinary GNU General Public License instead of this License to a given copy of the Library. To do this, you must alter all the notices that refer to this License, so that they refer to the ordinary GNU General Public License, version 2, instead of to this License. (If a newer version than version 2 of the ordinary GNU General Public License has appeared, then you can specify that version instead if you wish.) Do not make any other change in these notices.

Once this change is made in a given copy, it is irreversible for that copy, so the ordinary GNU General Public License applies to all subsequent copies and derivative works made from that copy.

This option is useful when you wish to copy part of the code of the Library into a program that is not a library.

4. You may copy and distribute the Library (or a portion or derivative of it, under Section 2) in object code or executable form under the terms of Sections 1 and 2 above provided that you accompany it with the complete corresponding machine-readable source code, which must be distributed under the terms of Sections 1 and 2 above on a medium customarily used for software interchange.

If distribution of object code is made by offering access to copy from a designated place, then offering equivalent access to copy the source code from the same place satisfies the requirement to distribute the source code, even though third parties are not compelled to copy the source along with the object code.

5. A program that contains no derivative of any portion of the Library, but is designed to work with the Library by being compiled or linked with it, is called a "work that uses the Library". Such a work, in isolation, is not a derivative work of the Library, and therefore falls outside the scope of this License.

However, linking a "work that uses the Library" with the Library creates an executable that is a derivative of the Library (because it contains portions of the Library), rather than a "work that uses the Library". The executable is therefore covered by this License. Section 6 states terms for distribution of such executables.

When a "work that uses the Library" uses material from a header file that is part of the Library, the object code for the work may be a derivative work of the Library even though the source code is not. Whether this is true is especially significant if the work can be linked without the Library, or if the work is itself a library. The threshold for this to be true is not precisely defined by law.

If such an object file uses only numerical parameters, data structure layouts and accessors, and small macros and small inline functions (ten lines or less in length), then the use of the object file is unrestricted, regardless of whether it is legally a derivative work. (Executables containing this object code plus portions of the Library will still fall under Section 6.)

Otherwise, if the work is a derivative of the Library, you may distribute the object code for the work under the terms of Section 6. Any executables containing that work also fall under Section 6, whether or not they are linked directly with the Library itself.

6. As an exception to the Sections above, you may also combine or link a "work that uses the Library" with the Library to produce a work containing portions of the Library, and distribute that work under terms of your choice, provided that the terms permit modification of the work for the customer's own use and reverse engineering for debugging such modifications.

You must give prominent notice with each copy of the work that the Library is used in it and that the Library and its use are covered by this License. You must supply a copy of this License. If the work during execution displays copyright notices, you must include the copyright notice for the Library among them, as well as a reference directing the user to the copy of this License. Also, you must do one of these things:

- a) Accompany the work with the complete corresponding machine-readable source code for the Library including whatever changes were used in the work (which must be distributed under Sections 1 and 2 above); and, if the work is an executable linked with the Library, with the complete machine-readable "work that uses the Library", as object code and/or source code, so that the user can modify the Library and then relink to produce a modified executable containing the modified Library. (It is understood that the user who changes the contents of definitions files in the Library will not necessarily be able to recompile the application to use the modified definitions.)

- b) Use a suitable shared library mechanism for linking with the Library. A suitable mechanism is one that (1) uses at run time a copy of the library already present on the user's computer system, rather than copying library functions into the executable, and (2) will operate properly with a modified version of the library, if the user installs one, as long as the modified version is interface-compatible with the version that the work was made with.

- c) Accompany the work with a written offer, valid for at least three years, to give the same user the materials specified in Subsection 6a, above, for a charge no more than the cost of performing this distribution.

- d) If distribution of the work is made by offering access to copy from a designated place, offer equivalent access to copy the above specified materials from the same place.

- e) Verify that the user has already received a copy of these materials or that you have already sent this user a copy.

For an executable, the required form of the "work that uses the Library" must include any data and utility programs needed for reproducing the executable from it. However, as a special exception, the materials to be distributed need not include anything that is normally distributed (in either source or binary form) with the major components (compiler, kernel, and so on) of the operating system on which the executable runs, unless that component itself accompanies the executable.

It may happen that this requirement contradicts the license restrictions of other proprietary libraries that do not normally accompany the operating system. Such a contradiction means you cannot use both them and the Library together in an executable that you distribute.

7. You may place library facilities that are a work based on the Library side-by-side in a single library together with other library facilities not covered by this License, and distribute such a combined library, provided that the separate distribution of the work based on the Library and of the other library facilities is otherwise permitted, and provided that you do these two things:

- a) Accompany the combined library with a copy of the same work based on the Library, uncombined with any other library facilities. This must be distributed under the terms of the Sections above.

- b) Give prominent notice with the combined library of the fact that part of it is a work based on the Library, and explaining where to find the accompanying uncombined form of the same work.

8. You may not copy, modify, sublicense, link with, or distribute the Library except as expressly provided under this License. Any attempt otherwise to copy, modify, sublicense, link with, or distribute the Library is void, and will automatically terminate your rights under this License. However, parties who have received copies, or rights, from you under this License will not have their licenses terminated so long as such parties remain in full compliance.

9. You are not required to accept this License, since you have not signed it. However, nothing else grants you permission to modify or distribute the Library or its derivative works. These actions are prohibited by law if you do not accept this License. Therefore, by modifying or distributing the Library (or any work based on the Library), you indicate your acceptance of this License to do so, and all its terms and conditions for copying, distributing or modifying the Library or works based on it.

10. Each time you redistribute the Library (or any work based on the Library), the recipient automatically receives a license from the original licensor to copy, distribute, link with or modify the Library subject to these terms and conditions. You may not impose any further restrictions on the recipients' exercise of the rights granted herein. You are not responsible for enforcing compliance by third parties with this License.

11. If, as a consequence of a court judgment or allegation of patent infringement or for any other reason (not limited to patent issues), conditions are imposed on you (whether by court order, agreement or otherwise) that contradict the conditions of this License, they do not excuse you from the conditions of this License. If you cannot distribute so as to satisfy simultaneously your obligations under this License and any other pertinent obligations, then as a consequence you may not distribute the Library at all. For example, if a patent license would not permit royalty-free redistribution of the Library by all those who receive copies directly or indirectly through you, then the only way you could satisfy both it and this License would be to refrain entirely from distribution of the Library.

If any portion of this section is held invalid or unenforceable under any particular circumstance, the balance of the section is intended to apply, and the section as a whole is intended to apply in other circumstances.

It is not the purpose of this section to induce you to infringe any patents or other property right claims or to contest validity of any such claims; this section has the sole purpose of protecting the integrity of the free software distribution system which is implemented by public license practices. Many people have made generous contributions to the wide range of software distributed through that system in reliance on consistent application of that system; it is up to the author/donor to decide if he or she is willing to distribute software through any other system and a licensee cannot impose that choice.

This section is intended to make thoroughly clear what is believed to be a consequence of the rest of this License.

12. If the distribution and/or use of the Library is restricted in certain countries either by patents or by copyrighted interfaces, the original copyright holder who places the Library under this License may add an explicit geographical distribution limitation excluding those countries, so that distribution is permitted only in or among countries not thus excluded. In such case, this License incorporates the limitation as if written in the body of this License.
13. The Free Software Foundation may publish revised and/or new versions of the Lesser General Public License from time to time. Such new versions will be similar in spirit to the present version, but may differ in detail to address new problems or concerns.

Each version is given a distinguishing version number. If the Library specifies a version number of this License which applies to it and "any later version", you have the option of following the terms and conditions either of that version or of any later version published by the Free Software Foundation. If the Library does not specify a license version number, you may choose any version ever published by the Free Software Foundation.
14. If you wish to incorporate parts of the Library into other free programs whose distribution conditions are incompatible with these, write to the author to ask for permission. For software which is copyrighted by the Free Software Foundation, write to the Free Software Foundation; we sometimes make exceptions for this. Our decision will be guided by the two goals of preserving the free status of all derivatives of our free software and of promoting the sharing and reuse of software generally.

NO WARRANTY

15. BECAUSE THE LIBRARY IS LICENSED FREE OF CHARGE, THERE IS NO WARRANTY FOR THE LIBRARY, TO THE EXTENT PERMITTED BY APPLICABLE LAW. EXCEPT WHEN OTHERWISE STATED IN WRITING THE COPYRIGHT HOLDERS AND/OR OTHER PARTIES PROVIDE THE LIBRARY "AS IS" WITHOUT WARRANTY OF ANY KIND, EITHER EXPRESSED OR IMPLIED, INCLUDING, BUT NOT LIMITED TO, THE IMPLIED WARRANTIES OF MERCHANTABILITY AND FITNESS FOR A PARTICULAR PURPOSE. THE ENTIRE RISK AS TO THE QUALITY AND PERFORMANCE OF THE LIBRARY IS WITH YOU. SHOULD THE LIBRARY PROVE DEFECTIVE, YOU ASSUME THE COST OF ALL NECESSARY SERVICING, REPAIR OR CORRECTION.
16. IN NO EVENT UNLESS REQUIRED BY APPLICABLE LAW OR AGREED TO IN WRITING WILL ANY COPYRIGHT HOLDER, OR ANY OTHER PARTY WHO MAY MODIFY AND/OR REDISTRIBUTE THE LIBRARY AS PERMITTED ABOVE, BE LIABLE TO YOU FOR DAMAGES, INCLUDING ANY GENERAL, SPECIAL, INCIDENTAL OR CONSEQUENTIAL DAMAGES ARISING OUT OF THE USE OR INABILITY TO USE THE LIBRARY (INCLUDING BUT NOT LIMITED TO LOSS OF DATA OR DATA BEING RENDERED INACCURATE OR LOSSES SUSTAINED BY YOU OR THIRD PARTIES OR A FAILURE OF THE LIBRARY TO OPERATE WITH ANY OTHER SOFTWARE), EVEN IF SUCH HOLDER OR OTHER PARTY HAS BEEN ADVISED OF THE POSSIBILITY OF SUCH DAMAGES.

END OF TERMS AND CONDITIONS

How to Apply These Terms to Your New Libraries

If you develop a new library, and you want it to be of the greatest possible use to the public, we recommend making it free software that everyone can redistribute and change. You can do so by permitting redistribution under these terms (or, alternatively, under the terms of the ordinary General Public License).

To apply these terms, attach the following notices to the library. It is safest to attach them to the start of each source file to most effectively convey the exclusion of warranty; and each file should have at least the "copyright" line and a pointer to where the full notice is found.

```
<one line to give the library's name and a brief idea of what it does.>  
Copyright © <year> <name of author>
```

This library is free software; you can redistribute it and/or modify it under the terms of the GNU Lesser General Public License as published by the Free Software Foundation; either version 2.1 of the License, or (at your option) any later version.

This library is distributed in the hope that it will be useful, but WITHOUT ANY WARRANTY; without even the implied warranty of MERCHANTABILITY or FITNESS FOR A PARTICULAR PURPOSE. See the GNU Lesser General Public License for more details.

You should have received a copy of the GNU Lesser General Public License along with this library; if not, write to the Free Software Foundation, Inc., 51 Franklin Street, Fifth Floor, Boston, MA 02110-1301 USA

Also add information on how to contact you by electronic and paper mail.

You should also get your employer (if you work as a programmer) or your school, if any, to sign a "copyright disclaimer" for the library, if necessary. Here is a sample; alter the names:

```
Yoyodyne, Inc., hereby disclaims all copyright interest in the library 'Frob'  
(a library for tweaking knobs) written by James Random Hacker.
```

```
<signature of Ty Coon>, 1 April 1990  
Ty Coon, President of Vice
```

That's all there is to it!

Note on source code distribution

For three years after the final factory shipment, you may request from Yamaha the source code for any portions of the product which are licensed under the GNU General Public License or GNU Lesser General Public License by writing to one of the Yamaha office addresses listed at the end of this Owner's Manual.

The source code will be provided at no charge; however, we may require you to reimburse Yamaha for the cost of delivering the source code to you.

- Note that we shall bear no responsibility whatsoever for any damage arising from changes (additions/ deletions) made to the software for this product by a third party other than Yamaha (or party authorized by Yamaha).
- Note that re-use of source code released to the public domain by Yamaha is unguaranteed, and Yamaha shall not bear any responsibility whatsoever for the source code.
- The source code can be downloaded from the following address:
<https://download.yamaha.com/sourcecodes/ekb/>

Note concernant la distribution du code source

Au cours des trois années qui suivent la sortie d'usine, vous pouvez demander à Yamaha le code source de toute partie du produit fourni sous licence dans le cadre d'une licence GNU General Public License ou GNU Lesser General Public License en envoyant un courrier à l'un des bureaux de Yamaha répertoriés dans la liste figurant à la fin du présent mode d'emploi.

Le code source vous sera fourni gratuitement. Nous pouvons toutefois vous demander de rembourser à Yamaha les frais d'expédition du code.

- Notez que nous déclinons toute responsabilité pour les dommages résultant de modifications (ajouts/suppressions) apportées au logiciel de ce produit par un tiers autre que Yamaha (ou qu'une partie autorisée par Yamaha).
- Notez que la réutilisation du code source distribué dans le domaine public par Yamaha n'est pas garantie et que Yamaha décline toute responsabilité pour le code source.
- Vous pouvez télécharger le code source à l'adresse suivante :
<https://download.yamaha.com/sourcecodes/ekb/>

Nota sobre la distribución del código fuente

Hasta tres años después de la salida final de fábrica, puede solicitar a Yamaha el código fuente de cualquier parte del producto para el que se concede licencia según la Licencia Pública General de GNU o la Licencia Pública General Reducida de GNU, enviando solicitud escrita a una de las direcciones de oficinas de Yamaha que aparecen al final de este Manual de instrucciones.

El código fuente se proporcionará sin cargo alguno; sin embargo, podríamos solicitarle que reembolse a Yamaha los gastos de envío.

- Debe tenerse en cuenta que no admitiremos responsabilidad alguna por cualesquiera daños que puedan derivarse de los cambios (adiciones o eliminaciones) realizados en el software de este producto por un tercero que no sea Yamaha (o alguien autorizado por Yamaha).
- Asimismo, debe tenerse en cuenta que la reutilización del código fuente que Yamaha hace de dominio público no tiene garantía alguna, y Yamaha no asumirá responsabilidad respecto a este código.
- El código fuente se puede descargar de la dirección siguiente:
<https://download.yamaha.com/sourcecodes/ekb/>

libpng

This copy of the libpng notices is provided for your convenience. In case of any discrepancy between this copy and the notices in the file png.h that is included in the libpng distribution, the latter shall prevail.

COPYRIGHT NOTICE, DISCLAIMER, and LICENSE:

If you modify libpng you may insert additional notices immediately following this sentence.

This code is released under the libpng license.

libpng versions 1.0.7, July 1, 2000 through 1.6.28, January 5, 2017 are Copyright (c) 2000-2002, 2004, 2006-2017 Glenn Randers-Pehrson, are derived from libpng-1.0.6, and are distributed according to the same disclaimer and license as libpng-1.0.6 with the following individuals added to the list of Contributing Authors:

Simon-Pierre Cadieux
Eric S. Raymond
Mans Rullgard
Cosmin Truta
Gilles Vollant
James Yu
Mandar Sahasrabudde

and with the following additions to the disclaimer:

There is no warranty against interference with your enjoyment of the library or against infringement. There is no warranty that our efforts or the library will fulfill any of your particular purposes or needs. This library is provided with all faults, and the entire risk of satisfactory quality, performance, accuracy, and effort is with the user.

Some files in the "contrib" directory and some configure-generated files that are distributed with libpng have other copyright owners and are released under other open source licenses.

libpng versions 0.97, January 1998, through 1.0.6, March 20, 2000, are Copyright (c) 1998-2000 Glenn Randers-Pehrson, are derived from libpng-0.96, and are distributed according to the same disclaimer and license as libpng-0.96, with the following individuals added to the list of Contributing Authors:

Tom Lane
Glenn Randers-Pehrson
Willem van Schaik

libpng versions 0.89, June 1996, through 0.96, May 1997, are Copyright (c) 1996-1997 Andreas Dilger, are derived from libpng-0.88, and are distributed according to the same disclaimer and license as libpng-0.88, with the following individuals added to the list of Contributing Authors:

John Bowler
Kevin Bracey
Sam Bushell
Magnus Holmgren
Greg Roelofs
Tom Tanner

Some files in the "scripts" directory have other copyright owners but are released under this license.

libpng versions 0.5, May 1995, through 0.88, January 1996, are Copyright (c) 1995-1996 Guy Eric Schalnat, Group 42, Inc.

For the purposes of this copyright and license, "Contributing Authors" is defined as the following set of individuals:

Andreas Dilger
Dave Martindale
Guy Eric Schalnat
Paul Schmidt
Tim Wegner

The PNG Reference Library is supplied "AS IS". The Contributing Authors and Group 42, Inc. disclaim all warranties, expressed or implied, including, without limitation, the warranties of merchantability and of fitness for any purpose. The Contributing Authors and Group 42, Inc. assume no liability for direct, indirect, incidental, special, exemplary, or consequential damages, which may result from the use of the PNG Reference Library, even if advised of the possibility of such damage.

Permission is hereby granted to use, copy, modify, and distribute this source code, or portions hereof, for any purpose, without fee, subject to the following restrictions:

1. The origin of this source code must not be misrepresented.
2. Altered versions must be plainly marked as such and must not be misrepresented as being the original source.
3. This Copyright notice may not be removed or altered from any source or altered source distribution.

The Contributing Authors and Group 42, Inc. specifically permit, without fee, and encourage the use of this source code as a component to supporting the PNG file format in commercial products. If you use this source code in a product, acknowledgment is not required but would be appreciated.

END OF COPYRIGHT NOTICE, DISCLAIMER, and LICENSE.

TRADEMARK:

The name "libpng" has not been registered by the Copyright owner as a trademark in any jurisdiction. However, because libpng has been distributed and maintained world-wide, continually since 1995, the Copyright owner claims "common-law trademark protection" in any jurisdiction where common-law trademark is recognized.

OSI CERTIFICATION:

Libpng is OSI Certified Open Source Software. OSI Certified Open Source is a certification mark of the Open Source Initiative. OSI has not addressed the additional disclaimers inserted at version 1.0.7.

EXPORT CONTROL:

The Copyright owner believes that the Export Control Classification Number (ECCN) for libpng is EAR99, which means not subject to export controls or International Traffic in Arms Regulations (ITAR) because it is open source, publicly available software, that does not contain any encryption software. See the EAR, paragraphs 734.3(b)(3) and 734.7(b).

Glenn Randers-Pehrson
glennrp at users.sourceforge.net
January 5, 2017

libuuid

Copyright: 1996, 1997, 1998, 1999, 2007 Theodore Ts'o.
1999 Andreas Dilger (adilger@enel.ucalgary.ca)

Redistribution and use in source and binary forms, with or without modification, are permitted provided that the following conditions are met:

1. Redistributions of source code must retain the above copyright notice, and the entire permission notice in its entirety, including the disclaimer of warranties.
2. Redistributions in binary form must reproduce the above copyright notice, this list of conditions and the following disclaimer in the documentation and/or other materials provided with the distribution.
3. The name of the author may not be used to endorse or promote products derived from this software without specific prior written permission.

THIS SOFTWARE IS PROVIDED "AS IS" AND ANY EXPRESS OR IMPLIED WARRANTIES, INCLUDING, BUT NOT LIMITED TO, THE IMPLIED WARRANTIES OF MERCHANTABILITY AND FITNESS FOR A PARTICULAR PURPOSE, ALL OF WHICH ARE HEREBY DISCLAIMED. IN NO EVENT SHALL THE AUTHOR BE LIABLE FOR ANY DIRECT, INDIRECT, INCIDENTAL, SPECIAL, EXEMPLARY, OR CONSEQUENTIAL DAMAGES (INCLUDING, BUT NOT LIMITED TO, PROCUREMENT OF SUBSTITUTE GOODS OR SERVICES; LOSS OF USE, DATA, OR PROFITS; OR BUSINESS INTERRUPTION) HOWEVER CAUSED AND ON ANY THEORY OF LIABILITY, WHETHER IN CONTRACT, STRICT LIABILITY, OR TORT (INCLUDING NEGLIGENCE OR OTHERWISE) ARISING IN ANY WAY OUT OF THE USE OF THIS SOFTWARE, EVEN IF NOT ADVISED OF THE POSSIBILITY OF SUCH DAMAGE.

libjpeg

This software is based in part on the work of the Independent JPEG Group.

imagemagick

Licensed under the ImageMagick License (the "License"); you may not use this file except in compliance with the License. You may obtain a copy of the License at

<https://www.imagemagick.org/script/license.php>

Unless required by applicable law or agreed to in writing, software distributed under the License is distributed on an "AS IS" BASIS, WITHOUT WARRANTIES OR CONDITIONS OF ANY KIND, either express or implied. See the License for the specific language governing permissions and limitations under the License.

FreeType

Portions of this software are copyright © 2016 The FreeType Project (www.freetype.org). All rights reserved.

ICU

COPYRIGHT AND PERMISSION NOTICE

Copyright © 1991-2016 Unicode, Inc. All rights reserved.
Distributed under the Terms of Use in <http://www.unicode.org/copyright.html>.

Permission is hereby granted, free of charge, to any person obtaining a copy of the Unicode data files and any associated documentation (the "Data Files") or Unicode software and any associated documentation (the "Software") to deal in the Data Files or Software without restriction, including without limitation the rights to use, copy, modify, merge, publish, distribute, and/or sell copies of the Data Files or Software, and to permit persons to whom the Data

Files or Software are furnished to do so, provided that either
(a) this copyright and permission notice appear with all copies of the Data Files or Software, or
(b) this copyright and permission notice appear in associated Documentation.

THE DATA FILES AND SOFTWARE ARE PROVIDED "AS IS", WITHOUT WARRANTY OF ANY KIND, EXPRESS OR IMPLIED, INCLUDING BUT NOT LIMITED TO THE WARRANTIES OF MERCHANTABILITY, FITNESS FOR A PARTICULAR PURPOSE AND NONINFRINGEMENT OF THIRD PARTY RIGHTS. IN NO EVENT SHALL THE COPYRIGHT HOLDER OR HOLDERS INCLUDED IN THIS NOTICE BE LIABLE FOR ANY CLAIM, OR ANY SPECIAL INDIRECT OR CONSEQUENTIAL DAMAGES, OR ANY DAMAGES WHATSOEVER RESULTING FROM LOSS OF USE, DATA OR PROFITS, WHETHER IN AN ACTION OF CONTRACT, NEGLIGENCE OR OTHER TORTIOUS ACTION, ARISING OUT OF OR IN CONNECTION WITH THE USE OR PERFORMANCE OF THE DATA FILES OR SOFTWARE.

Except as contained in this notice, the name of a copyright holder shall not be used in advertising or otherwise to promote the sale, use or other dealings in these Data Files or Software without prior written authorization of the copyright holder.

jemalloc

Copyright (C) 2002-2014 Jason Evans <jasone@canonware.com>. All rights reserved.
Copyright (C) 2007-2012 Mozilla Foundation. All rights reserved.
Copyright (C) 2009-2014 Facebook, Inc. All rights reserved.

Redistribution and use in source and binary forms, with or without modification, are permitted provided that the following conditions are met:

1. Redistributions of source code must retain the above copyright notice(s), this list of conditions and the following disclaimer.
2. Redistributions in binary form must reproduce the above copyright notice(s), this list of conditions and the following disclaimer in the documentation and/or other materials provided with the distribution.

THIS SOFTWARE IS PROVIDED BY THE COPYRIGHT HOLDER(S) "AS IS" AND ANY EXPRESS OR IMPLIED WARRANTIES, INCLUDING, BUT NOT LIMITED TO, THE IMPLIED WARRANTIES OF MERCHANTABILITY AND FITNESS FOR A PARTICULAR PURPOSE ARE DISCLAIMED. IN NO EVENT SHALL THE COPYRIGHT HOLDER(S) BE LIABLE FOR ANY DIRECT, INDIRECT, INCIDENTAL, SPECIAL, EXEMPLARY, OR CONSEQUENTIAL DAMAGES (INCLUDING, BUT NOT LIMITED TO, PROCUREMENT OF SUBSTITUTE GOODS OR SERVICES; LOSS OF USE, DATA, OR PROFITS; OR BUSINESS INTERRUPTION) HOWEVER CAUSED AND ON ANY THEORY OF LIABILITY, WHETHER IN CONTRACT, STRICT LIABILITY, OR TORT (INCLUDING NEGLIGENCE OR OTHERWISE) ARISING IN ANY WAY OUT OF THE USE OF THIS SOFTWARE, EVEN IF ADVISED OF THE POSSIBILITY OF SUCH DAMAGE.

libss2 / libcomerr2

Copyright 1987, 1988 by the Student Information Processing Board of the Massachusetts Institute of Technology

Permission to use, copy, modify, and distribute this software and its documentation for any purpose and without fee is hereby granted, provided that the above copyright notice appear in all copies and that both that copyright notice and this permission notice appear in supporting documentation, and that the names of M.I.T. and the M.I.T. S.I.P.B. not be used in advertising or publicity pertaining to distribution of the software without specific, written prior permission. M.I.T. and the M.I.T. S.I.P.B. make no representations about the suitability of this software for any purpose. It is provided "as is" without express or implied warranty.

libpopt0

Copyright (c) 1998 Red Hat Software

Permission is hereby granted, free of charge, to any person obtaining a copy of this software and associated documentation files (the "Software"), to deal in the Software without restriction, including without limitation the rights to use, copy, modify, merge, publish, distribute, sublicense, and/or sell copies of the Software, and to permit persons to whom the Software is furnished to do so, subject to the following conditions:

The above copyright notice and this permission notice shall be included in all copies or substantial portions of the Software.

THE SOFTWARE IS PROVIDED "AS IS", WITHOUT WARRANTY OF ANY KIND, EXPRESS OR IMPLIED, INCLUDING BUT NOT LIMITED TO THE WARRANTIES OF MERCHANTABILITY, FITNESS FOR A PARTICULAR PURPOSE AND NONINFRINGEMENT. IN NO EVENT SHALL THE X CONSORTIUM BE LIABLE FOR ANY CLAIM, DAMAGES OR OTHER LIABILITY, WHETHER IN AN ACTION OF CONTRACT, TORT OR OTHERWISE, ARISING FROM, OUT OF OR IN CONNECTION WITH THE SOFTWARE OR THE USE OR OTHER DEALINGS IN THE SOFTWARE.

Except as contained in this notice, the name of the X Consortium shall not be used in advertising or otherwise to promote the sale, use or other dealings in this Software without prior written authorization from the X Consortium.

pcre

PCRE LICENCE

PCRE is a library of functions to support regular expressions whose syntax and semantics are as close as possible to those of the Perl 5 language.

Release 8 of PCRE is distributed under the terms of the "BSD" licence, as specified below. The documentation for PCRE, supplied in the "doc" directory, is distributed under the same terms as the software itself.

The basic library functions are written in C and are freestanding. Also included in the distribution is a set of C++ wrapper functions, and a just-in-time compiler that can be used to optimize pattern matching. These are both optional features that can be omitted when the library is built.

THE BASIC LIBRARY FUNCTIONS

Written by: Philip Hazel
Email local part: ph10
Email domain: cam.ac.uk

University of Cambridge Computing Service,
Cambridge, England.

Copyright (c) 1997-2012 University of Cambridge
All rights reserved.

PCRE JUST-IN-TIME COMPILATION SUPPORT

Written by: Zoltan Herczeg
Email local part: hzmester
Email domain: freemail.hu

Copyright (c) 2010-2012 Zoltan Herczeg
All rights reserved.

STACK-LESS JUST-IN-TIME COMPILER

Written by: Zoltan Herczeg
Email local part: hzmester
Email domain: freemail.hu

Copyright (c) 2009-2012 Zoltan Herczeg
All rights reserved.

THE C++ WRAPPER FUNCTIONS

Contributed by: Google Inc.

Copyright (c) 2007-2012, Google Inc.
All rights reserved.

THE "BSD" LICENCE

Redistribution and use in source and binary forms, with or without modification, are permitted provided that the following conditions are met:

- * Redistributions of source code must retain the above copyright notice, this list of conditions and the following disclaimer.
- * Redistributions in binary form must reproduce the above copyright notice, this list of conditions and the following disclaimer in the documentation and/or other materials provided with the distribution.
- * Neither the name of the University of Cambridge nor the name of Google Inc. nor the names of their contributors may be used to endorse or promote products derived from this software without specific prior written permission.

THIS SOFTWARE IS PROVIDED BY THE COPYRIGHT HOLDERS AND CONTRIBUTORS "AS IS" AND ANY EXPRESS OR IMPLIED WARRANTIES, INCLUDING, BUT NOT LIMITED TO, THE IMPLIED WARRANTIES OF MERCHANTABILITY AND FITNESS FOR A PARTICULAR PURPOSE ARE DISCLAIMED. IN NO EVENT SHALL THE COPYRIGHT OWNER OR CONTRIBUTORS BE LIABLE FOR ANY DIRECT, INDIRECT, INCIDENTAL, SPECIAL, EXEMPLARY, OR CONSEQUENTIAL DAMAGES (INCLUDING, BUT NOT LIMITED TO, PROCUREMENT OF SUBSTITUTE GOODS OR SERVICES; LOSS OF USE, DATA, OR PROFITS; OR BUSINESS INTERRUPTION) HOWEVER CAUSED AND ON ANY THEORY OF LIABILITY, WHETHER IN CONTRACT, STRICT LIABILITY, OR TORT (INCLUDING NEGLIGENCE OR OTHERWISE) ARISING IN ANY WAY OUT OF THE USE OF THIS SOFTWARE, EVEN IF ADVISED OF THE POSSIBILITY OF SUCH DAMAGE.

End

Gen Shin Gothic

- Gen Shin Gothic is a variant of Source Han Sans that also contains some glyphs derived from M+ OUTLINE FONTS.
- The copyrights to the glyphs in the font data derived from Source Han Sans belong to Adobe.
- The copyrights to the glyphs in the font data derived from M+ OUTLINE FONTS belong to M+ FONTS PROJECT.
- The Gen Shin Gothic font files can be used under the same license as Source Han Sans, SIL Open Font License 1.1.

This Font Software is licensed under the SIL Open Font License, Version 1.1. This license is copied below, and is also available with a FAQ at: <http://scripts.sil.org/OFL>

SIL OPEN FONT LICENSE Version 1.1 - 26 February 2007

PREAMBLE

The goals of the Open Font License (OFL) are to stimulate worldwide development of collaborative font projects, to support the font creation efforts of academic and linguistic communities, and to provide a free and open framework in which fonts may be shared and improved in partnership with others.

The OFL allows the licensed fonts to be used, studied, modified and redistributed freely as long as they are not sold by themselves. The fonts, including any derivative works, can be bundled, embedded, redistributed and/or sold with any software provided that any reserved names are not used by derivative works. The fonts and derivatives, however, cannot be released under any other type of license. The requirement for fonts to remain under this license does not apply to any document created using the fonts or their derivatives.

DEFINITIONS

"Font Software" refers to the set of files released by the Copyright Holder(s) under this license and clearly marked as such. This may include source files, build scripts and documentation.

"Reserved Font Name" refers to any names specified as such after the copyright statement(s).

"Original Version" refers to the collection of Font Software components as distributed by the Copyright Holder(s).

"Modified Version" refers to any derivative made by adding to, deleting, or substituting -- in part or in whole -- any of the components of the Original Version, by changing formats or by porting the Font Software to a new environment.

"Author" refers to any designer, engineer, programmer, technical writer or other person who contributed to the Font Software.

PERMISSION & CONDITIONS

Permission is hereby granted, free of charge, to any person obtaining a copy of the Font Software, to use, study, copy, merge, embed, modify, redistribute, and sell modified and unmodified copies of the Font Software, subject to the following conditions:

- 1) Neither the Font Software nor any of its individual components, in Original or Modified Versions, may be sold by itself.
- 2) Original or Modified Versions of the Font Software may be bundled, redistributed and/or sold with any software, provided that each copy contains the above copyright notice and this license. These can be included either as stand-alone text files, human-readable headers or in the appropriate machine-readable metadata fields within text or binary files as long as those fields can be easily viewed by the user.
- 3) No Modified Version of the Font Software may use the Reserved Font Name(s) unless explicit written permission is granted by the corresponding Copyright Holder. This restriction only applies to the primary font name as presented to the users.
- 4) The name(s) of the Copyright Holder(s) or the Author(s) of the Font Software shall not be used to promote, endorse or advertise any Modified Version, except to acknowledge the contribution(s) of the Copyright Holder(s) and the Author(s) or with their explicit written permission.
- 5) The Font Software, modified or unmodified, in part or in whole, must be distributed entirely under this license, and must not be distributed under any other license. The requirement for fonts to remain under this license does not apply to any document created using the Font Software.

TERMINATION

This license becomes null and void if any of the above conditions are not met.

DISCLAIMER

THE FONT SOFTWARE IS PROVIDED "AS IS", WITHOUT WARRANTY OF ANY KIND, EXPRESS OR IMPLIED, INCLUDING BUT NOT LIMITED TO ANY WARRANTIES OF MERCHANTABILITY, FITNESS FOR A PARTICULAR PURPOSE AND NONINFRINGEMENT OF COPYRIGHT, PATENT, TRADEMARK, OR OTHER RIGHT. IN NO EVENT SHALL THE COPYRIGHT HOLDER BE LIABLE FOR ANY CLAIM, DAMAGES OR OTHER LIABILITY, INCLUDING ANY GENERAL, SPECIAL, INDIRECT, INCIDENTAL, OR CONSEQUENTIAL DAMAGES, WHETHER IN AN ACTION OF CONTRACT, TORT OR OTHERWISE, ARISING FROM, OUT OF THE USE OR INABILITY TO USE THE FONT SOFTWARE OR FROM OTHER DEALINGS IN THE FONT SOFTWARE.

Apache License2.0

Copyright (c) 2009-2018 Arm Limited. All rights reserved.

SPDX-License-Identifier: Apache-2.0

Licensed under the Apache License, Version 2.0 (the License); you may not use this file except in compliance with the License. You may obtain a copy of the License at

www.apache.org/licenses/LICENSE-2.0

Unless required by applicable law or agreed to in writing, software distributed under the License is distributed on an AS IS BASIS, WITHOUT WARRANTIES OR CONDITIONS OF ANY KIND, either express or implied. See the License for the specific language governing permissions and limitations under the License.

Modified BSD license

COPYRIGHT(c) 2016 STMicroelectronics

Redistribution and use in source and binary forms, with or without modification, are permitted provided that the following conditions are met:

1. Redistributions of source code must retain the above copyright notice, this list of conditions and the following disclaimer.
2. Redistributions in binary form must reproduce the above copyright notice, this list of conditions and the following disclaimer in the documentation and/or other materials provided with the distribution.
3. Neither the name of STMicroelectronics nor the names of its contributors may be used to endorse or promote products derived from this software without specific prior written permission.

THIS SOFTWARE IS PROVIDED BY THE COPYRIGHT HOLDERS AND CONTRIBUTORS "AS IS" AND ANY EXPRESS OR IMPLIED WARRANTIES, INCLUDING, BUT NOT LIMITED TO, THE IMPLIED WARRANTIES OF MERCHANTABILITY AND FITNESS FOR A PARTICULAR PURPOSE ARE DISCLAIMED. IN NO EVENT SHALL THE COPYRIGHT HOLDER OR CONTRIBUTORS BE LIABLE FOR ANY DIRECT, INDIRECT, INCIDENTAL, SPECIAL, EXEMPLARY, OR CONSEQUENTIAL DAMAGES (INCLUDING, BUT NOT LIMITED TO, PROCUREMENT OF SUBSTITUTE GOODS OR SERVICES; LOSS OF USE, DATA, OR PROFITS; OR BUSINESS INTERRUPTION) HOWEVER CAUSED AND ON ANY THEORY OF LIABILITY, WHETHER IN CONTRACT, STRICT LIABILITY, OR TORT (INCLUDING NEGLIGENCE OR OTHERWISE) ARISING IN ANY WAY OUT OF THE USE OF THIS SOFTWARE, EVEN IF ADVISED OF THE POSSIBILITY OF SUCH DAMAGE.

Credits and Copyrights for the pre-installed Songs

All I Want For Christmas Is You

Words and Music by Mariah Carey and Walter Afanasieff
Copyright © 1994 UNIVERSAL TUNES, BEYONDIDOLIZATION, SONY MUSIC PUBLISHING (US) LLC, TAMAL VISTA MUSIC and KOBALT MUSIC COPYRIGHTS SARL
All Rights for BEYONDIDOLIZATION Administered by UNIVERSAL TUNES
All Rights for SONY MUSIC PUBLISHING (US) LLC and TAMAL VISTA MUSIC Administered by SONY MUSIC PUBLISHING (US) LLC, 424 Church Street, Suite 1200, Nashville, TN 37219
All Rights for KOBALT MUSIC COPYRIGHTS SARL Administered Worldwide by KOBALT SONGS MUSIC PUBLISHING
All Rights Reserved Used by Permission

All The Things You Are

Lyrics by Oscar Hammerstein II
Music by Jerome Kern
Copyright © 1939 UNIVERSAL - POLYGRAM INTERNATIONAL PUBLISHING, INC.
Copyright Renewed
All Rights Reserved Used by Permission

Autumn Leaves

English lyric by Johnny Mercer
French lyric by Jacques Prevert
Music by Joseph Kosma
© 1947, 1950 (Renewed) ENOCH ET CIE
Sole Selling Agent for U.S. and Canada: MORLEY MUSIC CO., by agreement with ENOCH ET CIE
All Rights Reserved

Back For Good

Words and Music by Gary Barlow
Copyright © 1995 Sony Music Publishing (UK) Limited
All Rights Administered by Sony Music Publishing (US) LLC, 424 Church Street, Suite 1200, Nashville, TN 37219
International Copyright Secured All Rights Reserved

Bad Day

Words and Music by Daniel Powter
Copyright © 2005 Song 6 Music
All Rights Administered by BMG Rights Management (US) LLC
All Rights Reserved Used by Permission

Ballade Pour Adeline

By Paul de Senneville
Copyright © 1977 (Renewed) by Coronet-Delphine, Inc. (ASCAP)
All Rights Administered by Regent Music Corporation (BMI)
International Copyright Secured All Rights Reserved
Used by Permission

Beauty And The Beast

from BEAUTY AND THE BEAST
Music by Alan Menken
Lyrics by Howard Ashman
© 1991 Wonderland Music Company, Inc. and Walt Disney Music Company
All Rights Reserved. Used by Permission.

Billie Jean

Words and Music by Michael Jackson
Copyright © 1982 Mijac Music
All Rights Administered by Sony Music Publishing (US) LLC, 424 Church Street, Suite 1200, Nashville, TN 37219
International Copyright Secured All Rights Reserved

Blinding Lights

Words and Music by Abel Tesfaye, Max Martin, Jason Quenneville, Oscar Holter and Ahmad Balshe
Copyright © 2019 KMR Music Royalties II SCSp, MXM, Universal Music Corp., Sal And Co LP, WC Music Corp. and Songs Of Wolf Cousins
All Rights for KMR Music Royalties II SCSp and MXM Administered Worldwide by Kobalt Songs Music Publishing
All Rights for Sal And Co LP Administered by Universal Music Corp.
All Rights for Songs Of Wolf Cousins Administered by WC Music Corp.
All Rights Reserved Used by Permission

Can't Take My Eyes Off Of You

Words and Music by Bob Crewe and Bob Gaudio
Copyright (c) 1967 EMI Longitude Music, Songs Of Universal, Inc., PW Ballads and Seasons Four Music
Copyright Renewed
All Rights on behalf of EMI Longitude Music Administered by Sony Music Publishing (US) LLC, 424 Church Street, Suite 1200, Nashville, TN 37219
All Rights on behalf of PW Ballads and Seasons Four Music Administered by Songs Of Universal, Inc.
International Copyright Secured All Rights Reserved

Candle In The Wind

Words and Music by Elton John and Bernie Taupin
Copyright © 1973 UNIVERSAL/DICK JAMES MUSIC LTD.
Copyright Renewed
All Rights in the United States and Canada Controlled and Administered by UNIVERSAL - SONGS OF POLYGRAM INTERNATIONAL, INC.
All Rights Reserved Used by Permission

Clocks

Words and Music by Guy Berryman, Jon Buckland, Will Champion and Chris Martin
Copyright © 2002 by Universal Music Publishing MGB Ltd.
All Rights in the United States Administered by Universal Music - MGB Songs
International Copyright Secured All Rights Reserved

Cold Heart (PNAU Remix)

Words and Music by Elton John, Bernard J.P. Taupin, Nicholas Littlemore, Peter Mayes, Sam Littlemore, Dean Meredith and Andrew John Meecham
Copyright © 2021 UNIVERSAL MUSIC PUBLISHING LTD., COW DOG MUSIC, INC., HST PUBLISHING LTD., CHENFELD LTD., UNIVERSAL MUSIC PUBLISHING PTY LTD. and BMG RIGHTS MANAGEMENT (UK) LTD.
All Rights for UNIVERSAL MUSIC PUBLISHING LTD., COW DOG MUSIC, INC. and CHENFELD LTD. in the United States Administered by UNIVERSAL - POLYGRAM INTERNATIONAL PUBLISHING, INC.
All Rights for HST PUBLISHING LTD. and UNIVERSAL MUSIC PUBLISHING PTY LTD. in the United States Administered by UNIVERSAL - SONGS OF POLYGRAM INTERNATIONAL, INC.
All Rights for BMG RIGHTS MANAGEMENT (UK) LTD. Administered by BMG RIGHTS MANAGEMENT (US) LLC
All Rights Reserved Used by Permission - Contains elements of "Sacrifice" and "Rocket Man (I Think It's Gonna Be A Long Long Time)" by Elton John and Bernie Taupin

Dancing Queen

Words and Music by Benny Andersson, Bjorn Ulvaeus and Stig Anderson
Copyright © 1976, 1977 UNIVERSAL/UNION SONGS MUSIKFORLAG AB
Copyright Renewed
All Rights in the United States and Canada Administered by UNIVERSAL - POLYGRAM INTERNATIONAL PUBLISHING, INC. and EMI GROVE PARK MUSIC, INC.
All Rights Reserved Used by Permission

Don't You Worry 'Bout A Thing

Words and Music by Stevie Wonder
Copyright © 1973 Jobete Music Co., Inc. and Black Bull Music
Copyright Renewed
All Rights Administered by Sony Music Publishing (US) LLC, 424 Church Street, Suite 1200, Nashville, TN 37219
International Copyright Secured All Rights Reserved

Eternal Flame

Words and Music by Billy Steinberg, Tom Kelly and Susanna Hoffs
Copyright © 1988 Sony Music Publishing (US) LLC and Bangophile Music
All Rights on behalf of Sony Music Publishing (US) LLC Administered by Sony Music Publishing (US) LLC, 424 Church Street, Suite 1200, Nashville, TN 37219
All Rights on behalf of Bangophile Music Controlled and Administered by Songs Of Universal, Inc.
International Copyright Secured All Rights Reserved

Every Breath You Take

Music and Lyrics by Sting
Copyright © 1983 SONGS OF UNIVERSAL, INC.
All Rights Reserved Used by Permission

Fields Of Gold

Music and Lyrics by Sting
Copyright © 1993 SONGS OF UNIVERSAL, INC.
All Rights Reserved Used by Permission

Final Countdown

Words and Music by Joey Tempest
Copyright © 1986 EMI Music Publishing Ltd.
All Rights Administered by Sony Music Publishing (US) LLC, 424 Church Street, Suite 1200, Nashville, TN 37219
International Copyright Secured All Rights Reserved

The Girl From Ipanema (Garôta De Ipanema)

Music by Antônio Carlos Jobim
English Words by Norman Gimbel
Original Words by Vinicius De Moraes
Copyright © 1963 ANTONIO CARLOS JOBIM and VINICIUS DE MORAES, Brazil
Copyright Renewed 1991 and Assigned to SONGS OF UNIVERSAL, INC. and WORDS WEST LLC
English Words Renewed 1991 by NORMAN GIMBEL for the World and Assigned to WORDS WEST LLC (P.O. Box 15187, Beverly Hills, CA 90209 USA)
All Rights Reserved Used by Permission

Hallelujah

Words and Music by Leonard Cohen
Copyright © 1985 Sony Music Publishing (US) LLC
All Rights Administered by Sony Music Publishing (US) LLC, 424 Church Street, Suite 1200, Nashville, TN 37219
International Copyright Secured All Rights Reserved

Hey Jude

Words and Music by John Lennon and Paul McCartney
Copyright © 1968 Sony Music Publishing (US) LLC
Copyright Renewed
All Rights Administered by Sony Music Publishing (US) LLC, 424 Church Street, Suite 1200, Nashville, TN 37219
International Copyright Secured All Rights Reserved

Higher Love

Words and Music by Will Jennings and Steve Winwood
Copyright © 1986 BLUE SKY RIDER SONGS and F.S. MUSIC LTD.
All Rights for BLUE SKY RIDER SONGS Administered by IRVING MUSIC, INC.
All Rights for F.S. MUSIC LTD. Administered Worldwide by SONGS OF KOBALT MUSIC PUBLISHING
All Rights Reserved Used by Permission

The House Of The Rising Sun

Words and Music by Alan Price
Copyright © 1964 Keith Prowse Music Publishing Co., Ltd. and Anthem Cantaloupe Music
Copyright Renewed
All Rights Administered by Sony Music Publishing (US) LLC, 424 Church Street, Suite 1200, Nashville, TN 37219
International Copyright Secured All Rights Reserved

I Will Always Love You

Words and Music by Dolly Parton
Copyright © 1973 Velvet Apple Music
Copyright Renewed
All Rights Administered by Sony Music Publishing (US) LLC, 424 Church Street, Suite 1200, Nashville, TN 37219
International Copyright Secured All Rights Reserved

In The Mood

By Joe Garland
Copyright © 1939, 1960 Shapiro, Bernstein & Co., Inc., New York
Copyright Renewed
All Rights Administered Worldwide by Reservoir Media Management, Inc.
All Rights Reserved Used by Permission

Into The Unknown

from FROZEN 2
Music and Lyrics by Kristen Anderson-Lopez and Robert Lopez
© 2019 Wonderland Music Company, Inc.
All Rights Reserved. Used by Permission.

It Must Have Been Love

Words and Music by Per Gessle
Copyright © 1990 JIMMY FUN MUSIC
All Rights Administered in the United States and Canada by UNIVERSAL - SONGS OF POLYGRAM INTERNATIONAL, INC.
All Rights Reserved Used by Permission

Just The Way You Are

Words and Music by Billy Joel
Copyright © 1977 IMPULSIVE MUSIC
Copyright Renewed
All Rights Administered by ALMO MUSIC CORP.
All Rights Reserved Used by Permission

La Bamba

By Richard Valenzuela
Copyright © 1959 EMI Longitude Music and Valens Heirs Designee
Copyright Renewed
All Rights Administered by Sony Music Publishing (US) LLC, 424 Church Street, Suite 1200, Nashville, TN 37219

International Copyright Secured All Rights Reserved

Let It Be

Words and Music by John Lennon and Paul McCartney
Copyright © 1970 Sony Music Publishing (US) LLC
Copyright Renewed
All Rights Administered by Sony Music Publishing (US) LLC, 424 Church Street, Suite 1200, Nashville, TN 37219
International Copyright Secured All Rights Reserved

Let It Go

from FROZEN
Music and Lyrics by Kristen Anderson-Lopez and Robert Lopez
© 2013 Wonderland Music Company, Inc.
All Rights Reserved. Used by Permission.

Let There Be Love

Lyric by Ian Grant
Music by Lionel Rand
Copyright © 1940 Shapiro, Bernstein & Co., Inc., New York
Copyright Renewed
All Rights Administered Worldwide by Reservoir Media Management, Inc.
All Rights Reserved Used by Permission

Lover

Words and Music by Taylor Swift
Copyright © 2019 Sony Music Publishing (US) LLC and Taylor Swift Music
All Rights Administered by Sony Music Publishing (US) LLC, 424 Church Street, Suite 1200, Nashville, TN 37219
International Copyright Secured All Rights Reserved

Mas Que Nada

Words and Music by Jorge Ben
Copyright © 1963 by Peermusic do Brasil Edições Musicais Ltda.
Copyright Renewed
All Rights Administered by Peer International Corporation
International Copyright Secured All Rights Reserved

Moon River

from the Paramount Picture BREAKFAST AT TIFFANY'S
Words by Johnny Mercer
Music by Henry Mancini
Copyright © 1961 Sony Music Publishing (US) LLC
Copyright Renewed
All Rights Administered by Sony Music Publishing (US) LLC, 424 Church Street, Suite 1200, Nashville, TN 37219
International Copyright Secured All Rights Reserved

Moves Like Jagger

Words and Music by Adam Levine, Benjamin Levin, Ammar Malik and Shellback
Copyright © 2010, 2011 by Universal Music - Careers, Sudgee Music, Matza Ball Music, Where Da Kasz At, Maru Cha Cha and MXM
All Rights for Sudgee Music Administered by Universal Music - Careers
All Rights for Matza Ball Music Administered by Concord Avenue c/o Concord Music Publishing
All Rights for Where Da Kasz At and Maru Cha Cha Administered Worldwide by Songs Of Kobalt Music Publishing
All Rights for MXM Administered Worldwide by Kobalt Songs Music Publishing
International Copyright Secured All Rights Reserved

My Heart Will Go On (Love Theme From 'Titanic')

from the Paramount and Twentieth Century Fox Motion Picture TITANIC
Music by James Horner
Lyric by Will Jennings
Copyright © 1997 Sony Harmony, Sony Melody, T C F Music Publishing, Inc., Fox Film Music Corporation and Blue Sky Rider Songs
All Rights on behalf of Sony Harmony and Sony Melody Administered by Sony Music Publishing (US) LLC, 424 Church Street, Suite 1200, Nashville, TN 37219
All Rights on behalf of Blue Sky Rider Songs Administered by Irving Music, Inc.
International Copyright Secured All Rights Reserved

My Life

Words and Music by Billy Joel
Copyright © 1978 IMPULSIVE MUSIC
All Rights Administered by ALMO MUSIC CORP.
All Rights Reserved Used by Permission

Perfect

Words and Music by Ed Sheeran
Copyright © 2017 Sony Music Publishing (UK) Limited
All Rights Administered by Sony Music Publishing (US) LLC, 424 Church Street, Suite 1200, Nashville, TN 37219
International Copyright Secured All Rights Reserved

Poker Face

Words and Music by Stefani Germanotta and RedOne
Copyright © 2008 Sony Music Publishing (US) LLC, House Of Gaga Publishing Inc. and RedOne Productions, LLC
All Rights Administered by Sony Music Publishing (US) LLC, 424 Church Street, Suite 1200, Nashville, TN 37219
International Copyright Secured All Rights Reserved

Pride And Joy

Written by Stevie Ray Vaughan
Copyright © 1985 Ray Vaughan Music (ASCAP)
All Rights Administered by Wixen Music Publishing, Inc.
All Rights Reserved Used by Permission

Route 66

By Bobby Troup
Copyright © 1946, Renewed 1973, Assigned 1974 to Londontown Music
All Rights outside the U.S.A. controlled by Edwin H. Morris & Company, A Division of MPL Music Publishing, Inc.
International Copyright Secured All Rights Reserved

Señorita

Words and Music by Camila Cabello, Charlotte Aitchison, Jack Patterson, Shawn Mendes, Magnus Hoiberg, Benjamin Levin, Ali Tamposi and Andrew Wotman
Copyright © 2019 Maidmetal Limited, Milamoon Songs, Stellar Songs Ltd., EMI Music Publishing Ltd., Songs Of Universal, Inc., Mendes Music, Infinite Stripes, Back Hair Music Publishing, Universal Music Works, Please Don't Forget To Pay Me Music, Reservoir 416 and Andrew Watt Music
All Rights on behalf of Maidmetal Limited, Milamoon Songs, Stellar Songs Ltd. and EMI Music Publishing Ltd. Administered by Sony Music Publishing (US) LLC, 424 Church Street, Suite 1200, Nashville, TN 37219
All Rights on behalf of Mendes Music, Infinite Stripes and Back Hair Music Publishing Administered by Songs Of Universal, Inc.

All Rights on behalf of Please Don't Forget To Pay Me Music Administered by Universal Music Works
All Rights on behalf of Reservoir 416 Administered Worldwide by Reservoir Media Management, Inc.
All Rights on behalf of Andrew Watt Music Administered Worldwide by Songs Of Kobalt Music Publishing
International Copyright Secured All Rights Reserved

Shallow

from A STAR IS BORN
Words and Music by Stefani Germanotta, Mark Ronson, Andrew Wyatt and Anthony Rossomando
Copyright © 2018 Sony Music Publishing (US) LLC, SG Songs Worldwide, Concord Copyrights, Songs Of Zelig, Concord Road, White Bull Music Group, Concord Boulevard, Stephaniesays Music, Warner-Barham Music, LLC and Warner-Olive Music, LLC
All Rights on behalf of Sony Music Publishing (US) LLC and SG Songs Worldwide Administered by Sony Music Publishing (US) LLC, 424 Church Street, Suite 1200, Nashville, TN 37219
All Rights on behalf of Songs Of Zelig Administered by Concord Copyrights c/o Concord Music Publishing
All Rights on behalf of White Bull Music Group Administered by Concord Road c/o Concord Music Publishing
All Rights on behalf of Stephaniesays Music Administered by Concord Boulevard c/o Concord Music Publishing
All Rights (Excluding Print) on behalf of Warner-Barham Music, LLC Administered by Songs Of Universal, Inc.
All Rights (Excluding Print) on behalf of Warner-Olive Music, LLC Administered by Universal Music Corp.
Exclusive Worldwide Print Rights on behalf of Warner-Barham Music, LLC and Warner-Olive Music, LLC Administered by Alfred Music International Copyright Secured All Rights Reserved

Someone Like You

Words and Music by Adele Adkins and Dan Wilson
Copyright © 2011 MELTED STONE PUBLISHING LTD., BMG MONARCH and SUGAR LAKE MUSIC
All Rights for MELTED STONE PUBLISHING LTD. in the U.S. and Canada Administered by UNIVERSAL - POLYGRAM INTERNATIONAL TUNES, INC.
All Rights for BMG MONARCH and SUGAR LAKE MUSIC Administered by BMG RIGHTS MANAGEMENT (US) LLC
All Rights Reserved Used by Permission

Someone You Loved

Words and Music by Lewis Capaldi, Benjamin Kohn, Peter Kelleher, Thomas Barnes and Samuel Roman
Copyright © 2018 BMG Gold Songs, BMG Rights Management (UK) Ltd., Sony Music Publishing (UK) Limited and EMI Music Publishing Ltd.
All Rights for BMG Gold Songs and BMG Rights Management (UK) Ltd. Administered by BMG Rights Management (US) LLC
All Rights for Sony Music Publishing (UK) Limited and EMI Music Publishing Ltd. Administered by Sony Music Publishing (US) LLC, 424 Church Street, Suite 1200, Nashville, TN 37219
All Rights Reserved Used by Permission

Spanish Eyes

Words by Charles Singleton and Eddie Snyder
Music by Bert Kaempfert
Copyright © 1965 Bert Kaempfert Music
Copyright Renewed
All Rights Administered by Sony Music Publishing (US) LLC, 424 Church Street, Suite 1200, Nashville, TN 37219
International Copyright Secured All Rights Reserved

10,000 Hours

Words and Music by Dan Smyers, Jordan Reynolds, Shay Mooney, Justin Bieber, Jason Boyd and Jessie Jo Dillon
© 2019 WC MUSIC CORP., BEATS AND BANJOS, BUCKEYE26, JREYNMUSIC, WARNER-TAMERLANE PUBLISHING CORP., SHAY MOONEY MUSIC, UNIVERSAL MUSIC CORP., BIEBER TIME PUBLISHING, BMG GOLD SONGS, POO BZ PUBLISHING INC., BIG MUSIC MACHINE and BIG ASS PILE OF DIMES MUSIC
All Rights for BEATS AND BANJOS, BUCKEYE26 and JREYNMUSIC Administered by WC MUSIC CORP.
All Rights for SHAY MOONEY MUSIC Administered by WARNER-TAMERLANE PUBLISHING CORP.
All Rights for BIEBER TIME PUBLISHING Administered by UNIVERSAL MUSIC CORP.
All Rights for BMG GOLD SONGS and POO BZ PUBLISHING INC. Administered by BMG RIGHTS MANAGEMENT (US) LLC
All Rights Reserved Used by Permission

Unchained Melody

Lyric by Hy Zaret
Music by Alex North
© 1955 (Renewed) North Melody Publishing (SESAC) and HZUM Publishing (SESAC) c/o Unchained Melody Publishing, LLC
All Rights Reserved Used by Permission

Up Where We Belong

from the Paramount Picture AN OFFICER AND A GENTLEMAN
Words by Will Jennings
Music by Buffy Sainte-Marie and Jack Nitzsche
Copyright © 1982 Sony Music Publishing (US) LLC
All Rights Administered by Sony Music Publishing (US) LLC, 424 Church Street, Suite 1200, Nashville, TN 37219
International Copyright Secured All Rights Reserved

What A Wonderful World

Words and Music by George David Weiss and Bob Thiele
Copyright © 1967 by Range Road Music Inc., Quartet Music and Abilene Music
Copyright Renewed
All Rights for Range Road Music Inc. Administered by Round Hill Carlin, LLC
All Rights for Quartet Music Administered by BMG Rights Management (US) LLC
All Rights for Abilene Music Administered by Concord Sounds c/o Concord Music Publishing International Copyright Secured All Rights Reserved
Used by Permission

White Christmas

from the Motion Picture Irving Berlin's HOLIDAY INN
Words and Music by Irving Berlin
© Copyright 1940, 1942 by Irving Berlin
Copyright Renewed
International Copyright Secured All Rights Reserved

Wonderful Tonight

Words and Music by Eric Clapton
Copyright © 1977 by Eric Patrick Clapton
Copyright Renewed
International Copyright Secured All Rights Reserved

Wonderwall

Words and Music by Noel Gallagher
Copyright © 1995 SM Music Publishing UK Limited and Oasis Music
All Rights Administered by Sony Music Publishing (US) LLC, 424 Church Street, Suite 1200, Nashville, TN 37219
International Copyright Secured All Rights Reserved

You've Lost That Lovin' Feelin'

Words and Music by Barry Mann, Cynthia Weil and Phil Spector
Copyright © 1964, 1965 Screen Gems-EMI Music Inc., Dyad Music Ltd. and Mother Bertha Music
Copyright Renewed
All Rights on behalf of Screen Gems-EMI Music Inc. Administered by Sony Music Publishing (US) LLC, 424 Church Street, Suite 1200, Nashville, TN 37219
International Copyright Secured All Rights Reserved

Your Song

Words and Music by Elton John and Bernie Taupin
Copyright © 1969 UNIVERSAL/DICK JAMES MUSIC LTD.
Copyright Renewed
All Rights in the United States and Canada Controlled and Administered by UNIVERSAL - SONGS OF POLYGRAM INTERNATIONAL, INC.
All Rights Reserved Used by Permission

For U.S.A.

This transmitter must not be co-located or operated in conjunction with any other antenna or transmitter.

(554-M01 FCC transmitter 01)

This equipment complies with FCC radiation exposure limits set forth for an uncontrolled environment and meets the FCC radio frequency (RF) Exposure Guidelines. This equipment has very low levels of RF energy that is deemed to comply without testing of specific absorption rate (SAR).

(554-M04 FCC portable 01)



Important Notice:

U.S. LIMITED WARRANTY for Customers in the United States

For detailed information about this Yamaha product and warranty service, please either visit the following website address (printable file is available at our website) or contact Customer Service at the address or telephone number identified below.

Website Address:

Yamaha.io/ClavinovaWarranty

Customer Service:

Yamaha Corporation of America
6600 Orangethorpe Avenue, Buena Park, CA 90620-1273
Telephone: 800-854-1569

For Canada

This equipment complies with ISED radiation exposure limits set forth for an uncontrolled environment and meets RSS-102 of the ISED radio frequency (RF) Exposure rules as this equipment has very low levels of RF energy.

Cet équipement est conforme aux limites d'exposition aux rayonnements énoncées pour un environnement non contrôlé et respecte les règles d'exposition aux fréquences radioélectriques (RF) CNR-102 de l'ISDE puisque cet appareil a un niveau très bas d'énergie RF.

(0555-M05_ised_portable_01)

This device contains licence-exempt transmitter(s)/receiver(s) that comply with Innovation, Science and Economic Development Canada's licence-exempt RSS(s). Operation is subject to the following two conditions:

1. This device may not cause interference.
2. This device must accept any interference, including interference that may cause undesired operation of the device.

L'émetteur/récepteur exempt de licence contenu dans le présent appareil est conforme aux CNR d'Innovation, Sciences et Développement économique Canada applicables aux appareils radio exempts de licence. L'exploitation est autorisée aux deux conditions suivantes :

1. L'appareil ne doit pas produire de brouillage ;
2. L'appareil doit accepter tout brouillage radioélectrique subi, même si le brouillage est susceptible d'en compromettre le fonctionnement.

(555-M13 ISED RSS 01)

For European Union and United Kingdom

EN	SIMPLIFIED EU DECLARATION OF CONFORMITY / SIMPLIFIED UK DECLARATION OF CONFORMITY
<p>Hereby, Yamaha Music Europe GmbH declares that the radio equipment type [CVP-909GP, CVP-909, CVP-905] is in compliance with Directive 2014/53/EU and the radio equipment regulations of UK. The full texts of the EU declaration of conformity and the UK declaration of conformity are available at the following internet address: https://europe.yamaha.com/en/support/compliance/doc.html</p>	
FR	DECLARATION UE DE CONFORMITE SIMPLIFIEE
<p>Le soussigné, Yamaha Music Europe GmbH, déclare que l'équipement radioélectrique du type [CVP-909GP, CVP-909, CVP-905] est conforme à la directive 2014/53/UE. Le texte complet de la déclaration UE de conformité est disponible à l'adresse internet suivante : https://europe.yamaha.com/en/support/compliance/doc.html</p>	
DE	VEREINFACHTE EU-KONFORMITÄTSERKLÄRUNG
<p>Hiermit erklärt Yamaha Music Europe GmbH, dass der Funkanlagentyp [CVP-909GP, CVP-909, CVP-905] der Richtlinie 2014/53/EU entspricht. Der vollständige Text der EU-Konformitätserklärung ist unter der folgenden Internetadresse verfügbar: https://europe.yamaha.com/en/support/compliance/doc.html</p>	
SV	FÖRENKLAD EU-FÖRSÄKRAN OM ÖVERENSSTÄMMELSE
<p>Härmed försäkrar Yamaha Music Europe GmbH att denna typ av radioutrustning [CVP-909GP, CVP-909, CVP-905] överensstämmer med direktiv 2014/53/EU. Den fullständiga texten till EU-försäkran om överensstämmelse finns på följande webbadress: https://europe.yamaha.com/en/support/compliance/doc.html</p>	
IT	DICHIARAZIONE DI CONFORMITÀ UE SEMPLIFICATA
<p>Il fabbricante, Yamaha Music Europe GmbH, dichiara che il tipo di apparecchiatura radio [CVP-909GP, CVP-909, CVP-905] è conforme alla direttiva 2014/53/UE. Il testo completo della dichiarazione di conformità UE è disponibile al seguente indirizzo Internet: https://europe.yamaha.com/en/support/compliance/doc.html</p>	
ES	DECLARACIÓN UE DE CONFORMIDAD SIMPLIFICADA
<p>Por la presente, Yamaha Music Europe GmbH declara que el tipo de equipo radioeléctrico [CVP-909GP, CVP-909, CVP-905] es conforme con la Directiva 2014/53/UE. El texto completo de la declaración UE de conformidad está disponible en la dirección Internet siguiente: https://europe.yamaha.com/en/support/compliance/doc.html</p>	
PT	DECLARAÇÃO UE DE CONFORMIDADE SIMPLIFICADA
<p>O(a) abaixo assinado(a) Yamaha Music Europe GmbH declara que o presente tipo de equipamento de rádio [CVP-909GP, CVP-909, CVP-905] está em conformidade com a Diretiva 2014/53/UE. O texto integral da declaração de conformidade está disponível no seguinte endereço de Internet: https://europe.yamaha.com/en/support/compliance/doc.html</p>	
NL	VEREENVOUDIGDE EU-CONFORMITEITSVERKLARING
<p>Hierbij verklaar ik, Yamaha Music Europe GmbH, dat het type radioapparatuur [CVP-909GP, CVP-909, CVP-905] conform is met Richtlijn 2014/53/EU. De volledige tekst van de EU-conformiteitsverklaring kan worden geraadpleegd op het volgende internetadres: https://europe.yamaha.com/en/support/compliance/doc.html</p>	
BG	ОПРОСТЕНА ЕС ДЕКЛАРАЦИЯ ЗА СЪОТВЕТСТВИЕ
<p>С настоящото Yamaha Music Europe GmbH декларира, че този тип радиосъоръжение [CVP-909GP, CVP-909, CVP-905] е в съответствие с Директива 2014/53/ЕС. Цялостният текст на ЕС декларацията за съответствие може да се намери на следния интернет адрес: https://europe.yamaha.com/en/support/compliance/doc.html</p>	
CS	ZJEDNODUŠENÉ EU PROHLÁŠENÍ O SHODĚ
<p>Tímto Yamaha Music Europe GmbH prohlašuje, že typ rádiového zařízení [CVP-909GP, CVP-909, CVP-905] je v souladu se směrnicí 2014/53/EU. Úplné znění EU prohlášení o shodě je k dispozici na této internetové adrese: https://europe.yamaha.com/en/support/compliance/doc.html</p>	
DA	FORENKLET EU-OVERENSSTEMMELSESERKLÆRING
<p>Hermed erklærer Yamaha Music Europe GmbH, at radioudstyrtypen [CVP-909GP, CVP-909, CVP-905] er i overensstemmelse med direktiv 2014/53/EU. EU-overensstemmelseserklæringens fulde tekst kan findes på følgende internetadresse: https://europe.yamaha.com/en/support/compliance/doc.html</p>	

ET	LIHSTUSSTATUD ELI VASTAVUSDEKLARATSIOON
<p>Käesolevaga deklareerib Yamaha Music Europe GmbH, et käesolev raadioseadme tüüp [CVP-909GP, CVP-909, CVP-905] vastab direktiivi 2014/53/EL nõuetele. ELi vastavusdeklaratsiooni täielik tekst on kättesaadav järgmisel internetiaadressil: https://europe.yamaha.com/en/support/compliance/doc.html</p>	
EL	ΑΠΛΟΥΣΤΕΥΜΕΝΗ ΔΗΛΩΣΗ ΣΥΜΜΟΡΦΩΣΗΣ ΕΕ
<p>Με την παρούσα ο/η Yamaha Music Europe GmbH, δηλώνει ότι ο ραδιοεξοπλισμός [CVP-909GP, CVP-909, CVP-905] πληροί την οδηγία 2014/53/ΕΕ. Το πλήρες κείμενο της δήλωσης συμμόρφωσης ΕΕ διατίθεται στην ακόλουθη ιστοσελίδα στο διαδίκτυο: https://europe.yamaha.com/en/support/compliance/doc.html</p>	
HR	POJEDNOSTAVLJENA EU IZJAVA O SUKLADNOSTI
<p>Yamaha Music Europe GmbH ovime izjavljuje da je radijska oprema tipa [CVP-909GP, CVP-909, CVP-905] u skladu s Direktivom 2014/53/EU. Cjeloviti tekst EU izjave o sukladnosti dostupan je na sljedećoj internetskoj adresi: https://europe.yamaha.com/en/support/compliance/doc.html</p>	
LV	VIENKĀRŠOTA ES ATBILSTĪBAS DEKLARĀCIJA
<p>Ar šo Yamaha Music Europe GmbH deklarē, ka radioiekārta [CVP-909GP, CVP-909, CVP-905] atbilst Direktīvai 2014/53/ES. Pilns ES atbilstības deklarācijas teksts ir pieejams šādā interneta vietnē: https://europe.yamaha.com/en/support/compliance/doc.html</p>	
LT	SUPAPRASTINTA ES ATITIKTIES DEKLARACIJA
<p>Aš, Yamaha Music Europe GmbH, patvirtinu, kad radijo įrenginių tipas [CVP-909GP, CVP-909, CVP-905] atitinka Direktyvą 2014/53/ES. Visas ES atitikties deklaracijos tekstas prieinamas šiuo interneto adresu: https://europe.yamaha.com/en/support/compliance/doc.html</p>	
HU	EGYSZERŰSÍTETT EU-MEGFELELŐSÉGI NYILATKOZAT
<p>Yamaha Music Europe GmbH igazolja, hogy a [CVP-909GP, CVP-909, CVP-905] típusú rádióberendezés megfelel a 2014/53/EU irányelvnek. Az EU-megfelelőségi nyilatkozat teljes szövege elérhető a következő internetes címen: https://europe.yamaha.com/en/support/compliance/doc.html</p>	
PL	UPROSZCZONA DEKLARACJA ZGODNOŚCI UE
<p>Yamaha Music Europe GmbH niniejszym oświadcza, że typ urządzenia radiowego [CVP-909GP, CVP-909, CVP-905] jest zgodny z dyrektywą 2014/53/UE. Pełny tekst deklaracji zgodności UE jest dostępny pod następującym adresem internetowym: https://europe.yamaha.com/en/support/compliance/doc.html</p>	
RO	DECLARAȚIA UE DE CONFORMITATE SIMPLIFICATĂ
<p>Prin prezenta, Yamaha Music Europe GmbH declară că tipul de echipamente radio [CVP-909GP, CVP-909, CVP-905] este în conformitate cu Directiva 2014/53/UE. Textul integral al declarației UE de conformitate este disponibil la următoarea adresă internet: https://europe.yamaha.com/en/support/compliance/doc.html</p>	
SK	ZJEDNODUŠENÉ EÚ VYHLÁSENIE O ZHODE
<p>Yamaha Music Europe GmbH týmto vyhlasuje, že rádiové zariadenie typu [CVP-909GP, CVP-909, CVP-905] je v súlade so smernicou 2014/53/EÚ. Úplné EÚ vyhlásenie o zhode je k dispozícii na tejto internetovej adrese: https://europe.yamaha.com/en/support/compliance/doc.html</p>	
SL	POENOSTAVLJENA IZJAVA EU O SKLADNOSTI
<p>Yamaha Music Europe GmbH potrjuje, da je tip radijske opreme [CVP-909GP, CVP-909, CVP-905] skladen z Direktivo 2014/53/EU. Celotno besedilo izjave EU o skladnosti je na voljo na naslednjem spletnem naslovu: https://europe.yamaha.com/en/support/compliance/doc.html</p>	
FI	YKSINKERTAISTETTU EU-VAATIMUSTENMUKAISUUSVAKUUTUS
<p>Yamaha Music Europe GmbH vakuuttaa, että radiolaitetyypit [CVP-909GP, CVP-909, CVP-905] on direktiivin 2014/53/EU mukainen. EU-vaatimustenmukaisuusvakuutuksen täysimittainen teksti on saatavilla seuraavassa internetosoitteessa: https://europe.yamaha.com/en/support/compliance/doc.html</p>	
TR	BASİTLEŞTİRİLMİŞ AVRUPA BİRLİĞİ UYGUNLUK BİLDİRİMİ
<p>İşbu belge ile, Yamaha Music Europe GmbH, radyo cihaz tipinin [CVP-909GP, CVP-909, CVP-905], Direktif 2014/53/ AB'ye uygunluğunu beyan eder. AB uyumu beyanının tam metni aşağıdaki internet adresinden edinilebilir: https://europe.yamaha.com/en/support/compliance/doc.html</p>	

(559-M01 RED DoC URL 02)

Important Notice: Guarantee Information for customers in European Economic Area (EEA) and Switzerland

<p>Important Notice: Guarantee Information for customers in EEA* and Switzerland</p> <p>For detailed guarantee information about this Yamaha product, and Pan-EEA* and Switzerland warranty service, please either visit the website address below (Printable file is available at our website) or contact the Yamaha representative office for your country. * EEA: European Economic Area</p>	English
<p>Wichtiger Hinweis: Garantie-Information für Kunden in der EWR* und der Schweiz</p> <p>Für nähere Garantie-Information über dieses Produkt von Yamaha, sowie über den Pan-EWR*- und Schweizer Garantieservice, besuchen Sie bitte entweder die folgend angegebene Internetadresse (eine druckfähige Version befindet sich auch auf unserer Webseite), oder wenden Sie sich an den für Ihr Land zuständigen Yamaha-Vertrieb. * EWR: Europäischer Wirtschaftsraum</p>	Deutsch
<p>Remarque importante: informations de garantie pour les clients de l'EEE et la Suisse</p> <p>Pour des informations plus détaillées sur la garantie de ce produit Yamaha et sur le service de garantie applicable dans l'ensemble de l'EEE ainsi qu'en Suisse, consultez notre site Web à l'adresse ci-dessous (le fichier imprimable est disponible sur notre site Web) ou contactez directement Yamaha dans votre pays de résidence. * EEE : Espace Economique Européen</p>	Français
<p>Belangrijke mededeling: Garantie-informatie voor klanten in de EER* en Zwitserland</p> <p>Voor gedetailleerde garantie-informatie over dit Yamaha-product en de garantieservice in heel de EER* en Zwitserland, gaat u naar de onderstaande website (u vindt een afdrukbaar bestand op onze website) of neemt u contact op met de vertegenwoordiging van Yamaha in uw land. * EER: Europese Economische Ruimte</p>	Nederlands
<p>Aviso importante: información sobre la garantía para los clientes del EEE* y Suiza</p> <p>Para una información detallada sobre este producto Yamaha y sobre el soporte de garantía en la zona EEE* y Suiza, visite la dirección web que se incluye más abajo (la versión del archivo para imprimir esta disponible en nuestro sitio web) o póngase en contacto con el representante de Yamaha en su país. * EEE: Espacio Económico Europeo</p>	Español
<p>Avviso importante: informazioni sulla garanzia per i clienti residenti nell'EEA* e in Svizzera</p> <p>Per informazioni dettagliate sulla garanzia relativa a questo prodotto Yamaha e l'assistenza in garanzia nei paesi EEA* e in Svizzera, potete consultare il sito Web all'indirizzo riportato di seguito (è disponibile il file in formato stampabile) oppure contattare l'ufficio di rappresentanza locale della Yamaha. * EEA: Area Economica Europea</p>	Italiano
<p>Aviso importante: informações sobre as garantias para clientes da AEE* e da Suíça</p> <p>Para obter uma informação pormenorizada sobre este produto da Yamaha e o serviço de garantia na AEE* e na Suíça, visite o site a seguir (o arquivo para impressão está disponível no nosso site) ou entre em contato com o escritório de representação da Yamaha no seu país. * AEE: Área Económica Européia</p>	Português
<p>Σημαντική σημείωση: Πληροφορίες εγγύησης για τους πελάτες στον ΕΟΧ* και Ελλάδα</p> <p>Για λεπτομερείς πληροφορίες εγγύησης σχετικά με το παρόν προϊόν της Yamaha και την κάλυψη εγγύησης σε όλες τις χώρες του ΕΟΧ και την Ελλάδα, επισκεφτείτε την παρακάτω ιστοσελίδα (Εκτυπώσιμη μορφή είναι διαθέσιμη στην ιστοσελίδα μας) ή απευθυνθείτε στην αντιπροσωπεία της Yamaha στη χώρα σας. * ΕΟΧ: Ευρωπαϊκός Οικονομικός Χώρος</p>	Ελληνικά
<p>Viktigt: Garantiinformation för kunder i EES-området* och Schweiz</p> <p>För detaljerad information om denna Yamahaprodukt samt garantiservice i hela EES-området* och Schweiz kan du antingen besöka nedanstående webbadress (en utskriftsvänlig fil finns på webbplatsen) eller kontakta Yamahas officiella representant i ditt land. * EES: Europeiska Ekonomiska Samarbetsområdet</p>	Svenska
<p>Viktig merknad: Garantiinformasjon for kunder i EØS* og Sveits</p> <p>Detaljert garantiinformasjon om dette Yamaha-produktet og garantiservice for hele EØS-området* og Sveits kan fås enten ved å besøke nettstedene nedenfor (utskriftsversjon finnes på våre nettsider) eller kontakte Yamahas kontoret i landet der du bor. * EØS: Det europeiske økonomiske samarbeidsområdet</p>	Norsk
<p>Vigtig oplysning: Garantioplysninger til kunder i EØO* og Schweiz</p> <p>De kan finde detaljerede garantioplysninger om dette Yamaha-produkt og den fælles garantiserviceordning for EØO* (og Schweiz) ved at besøge det websted, der er angivet nedenfor (der findes en fil, som kan udskrives, på vores websted), eller ved at kontakte Yamahas nationale repræsentationskontor i det land, hvor De bor. * EØO: Det Europæiske Økonomiske Område</p>	Dansk
<p>Tärkeä ilmoitus: Takuutiedot Euroopan talusalueen (ETA) ja Sveitsin asiakkaille</p> <p>Tämän Yamaha-tuotteen sekä ETA-alueen ja Sveitsin takuuta koskevat yksityiskohtaiset tiedot saatte alla olevasta nettiosoitteesta. (Tulostettava tiedosto saatavissa sivustollamme.) Voitte myös ottaa yhteyttä paikalliseen Yamaha-edustajaan. *ETA: Euroopan talusalue</p>	Suomi
<p>Ważne: Warunki gwarancyjne obowiązujące w EOG* i Szwajcarii</p> <p>Aby dowiedzieć się więcej na temat warunków gwarancyjnych tego produktu firmy Yamaha i serwisu gwarancyjnego w całym EOG* i Szwajcarii, należy odwiedzić wskazaną poniżej stronę internetową (Plik gotowy do wydruku znajduje się na naszej stronie internetowej) lub skontaktować się z przedstawicielstwem firmy Yamaha w swoim kraju. * EOG — Europejski Obszar Gospodarczy</p>	Polski
<p>Důležité oznámení: Záruční informace pro zákazníky v EHS* a ve Švýcarsku</p> <p>Podrobné záruční informace o tomto produktu Yamaha a záručním servisu v celém EHS* a ve Švýcarsku naleznete na níže uvedené webové adrese (soubor k tisku je dostupný na našich webových stránkách) nebo se můžete obrátit na zastoupení firmy Yamaha ve své zemi. * EHS: Evropský hospodářský prostor</p>	Česky
<p>Fontos figyelmeztetés: Garancia-információk az EGT* területén és Svájcban élő vásárlók számára</p> <p>A jelen Yamaha termékre vonatkozó részletes garancia-információk, valamint az EGT*-re és Svájcra kiterjedő garanciális szolgáltatás tekintetében keresse fel webhelyünket az alábbi címen (a webhelyen nyomtatható fájl is talál), vagy pedig lépjen kapcsolatba az országában működő Yamaha képviselői irodával. * EGT: Európai Gazdasági Térség</p>	Magyar
<p>Oluline märkus: Garantiteave Euroopa Majanduspiirkonna (EMP)* ja Šveitsi klientidele</p> <p>Täpsema teabe saamiseks selle Yamaha toote garantii ning kogu Euroopa Majanduspiirkonna ja Šveitsi garantiiteeninduse kohta, külastage palun veebisaiti alljärgneval aadressil (meie saidil on saadaval printitav fail) või pöörduge Teie regiooni Yamaha esinduse poole. * EMP: Euroopa Majanduspiirkond</p>	Eesti keel
<p>Svarīgs paziņojums: garantijas informācija klientiem EEZ* un Šveicē</p> <p>Lai saņemtu detalizētu garantijas informāciju par šo Yamaha produktu, kā arī garantijas apkalpošanu EEZ* un Šveicē, lūdzam apmeklējiet zemāk norādīto tīmekļa vietnes adresi (tīmekļa vietnē ir pieejams drukājams fails) vai zvanieties ar jūsu valsti apkalpojošo Yamaha pārstāvniecību. * EEZ: Eiropas Ekonomikas zona</p>	Latviešu
<p>Děmesio: informacija dėl garantijos pirkėjams EEE* ir Šveicarijoje</p> <p>Jei reikia išsamios informacijos apie šį „Yamaha“ produktą ir jo techninę priežiūrą visoje EEE* ir Šveicarijoje, apsilankykite mūsų svetainėje toliau nurodytu adresu (svetainėje yra spausdintinas failas) arba kreipkitės į „Yamaha“ atstovybę savo šaliai. *EEE – Europos ekonominė erdvė</p>	Lietuvių kalba
<p>Dôležité upozornenie: Informácie o záruke pre zákazníkov v EHP* a Švajčiarsku</p> <p>Podrobné informácie o záruke týkajúce sa tohto produktu od spoločnosti Yamaha a garančnom servise v EHP* a Švajčiarsku nájdete na webovej stránke uvedenej nižšie (na našej webovej stránke je k dispozícii súbor na tlač) alebo sa obráťte na zástupcu spoločnosti Yamaha vo svojej krajine. * EHP: Európsky hospodársky priestor</p>	Slovenčina
<p>Pomembno obvestilo: Informacije o garanciji za kupce v EGP* in Švici</p> <p>Za podrobnejše informacije o tem Yamahinem izdelku ter garancijskem servisu v celotnem EGP in Švici, obiščite spletno mesto, ki je navedeno spodaj (natisljiva datoteka je na voljo na našem spletnem mestu), ali se obrnite na Yamahinega predstavnika v svoji državi. * EGP: Evropski gospodarski prostor</p>	Slovenščina
<p>Важно съобщение: Информация за гаранцията за клиенти в ЕИП* и Швейцария</p> <p>За подробна информация за гаранцията за този продукт на Yamaha и гаранционното обслужване в паневропейската зона на ЕИП* и Швейцария или посетете посочения по-долу уеб сайт (на нашия уеб сайт има файл за печат), или се свържете с представителния офис на Yamaha във вашата страна. * ЕИП: Европейско икономическо пространство</p>	Български език
<p>Notificare importantă: Informații despre garanție pentru clienții din SEE* și Elveția</p> <p>Pentru informații detaliate privind acest produs Yamaha și serviciul de garanție Pan-SEE* și Elveția, vizitați site-ul la adresa de mai jos (fișierul imprimabil este disponibil pe site-ul nostru) sau contactați biroul reprezentanței Yamaha din țara dumneavoastră. * SEE: Spațiul Economic European</p>	Limba română
<p>Važna obavijest: Informacije o jamstvu za države EGP-a i Švicarske</p> <p>Za detaljne informacije o jamstvu za ovaj Yamahin proizvod te jamstvenom servisu za cijeli EGP i Švicarsku, molimo Vas da posjetite web-stranicu navedenu u nastavku ili kontaktirate ovlaštenog Yamahinog dobavljača u svojoj zemlji. * EGP: Evropski gospodarski prostor</p>	Hrvatski

<https://europe.yamaha.com/warranty/>

For details of products, please contact your nearest Yamaha representative or the authorized distributor listed below.

Pour plus de détails sur les produits, veuillez-vous adresser à Yamaha ou au distributeur le plus proche de vous figurant dans la liste suivante.

Die Einzelheiten zu Produkten sind bei Ihrer unten aufgeführten Niederlassung und bei Yamaha Vertragshändlern in den jeweiligen Bestimmungsländern erhältlich.

Para detalles sobre productos, contacte su tienda Yamaha más cercana o el distribuidor autorizado que se lista debajo.

NORTH AMERICA

CANADA

Yamaha Canada Music Ltd.
135 Milner Avenue, Toronto, Ontario M1S 3R1,
Canada
Tel: +1-416-298-1311

U.S.A.

Yamaha Corporation of America
6600 Orangethorpe Avenue, Buena Park,
CA 90620, U.S.A.
Tel: +1-714-522-9011

CENTRAL & SOUTH AMERICA

MEXICO

Yamaha de México, S.A. de C.V.
Av. Insurgentes Sur 1647 Piso 9, Col. San José
Insurgentes, Delegación Benito Juárez, CDMX,
C.P. 03900, México
Tel: +52-55-5804-0600

BRAZIL

Yamaha Musical do Brasil Ltda.
Praça Professor José Lannes, 40-Cjs 21 e 22,
Brooklin Paulista Novo CEP 04571-100 – São
Paulo – SP, Brazil
Tel: +55-11-3704-1377

ARGENTINA

**Yamaha Music Latin America, S.A.,
Sucursal Argentina**
Olga Cossetini 1553, Piso 4 Norte,
Madero Este-C1107CEK,
Buenos Aires, Argentina
Tel: +54-11-4119-7000

PANAMA AND OTHER LATIN AMERICAN REGIONS/CARIBBEAN REGIONS

Yamaha Music Latin America, S.A.
Edificio Torre Davivienda, Piso: 20 Avenida
Balboa, Marbella, Corregimiento de Bella Vista,
Ciudad de Panamá, Rep. de Panamá
Tel: +507-269-5311

EUROPE

THE UNITED KINGDOM/IRELAND

Yamaha Music Europe GmbH (UK)
Sherbourne Drive, Tilbrook, Milton Keynes,
MK7 8BL, U.K.
Tel: +44-1908-366700

GERMANY

Yamaha Music Europe GmbH
Siemensstrasse 22-34, 25462 Rellingen, Germany
Tel: +49-4101-303-0

SWITZERLAND/LIECHTENSTEIN

**Yamaha Music Europe GmbH, Branch
Switzerland in Thalwil**
Seestrasse 18a, 8800 Thalwil, Switzerland
Tel: +41-44-3878080

AUSTRIA/CROATIA/CZECH REPUBLIC/ HUNGARY/ROMANIA/SLOVAKIA/ SLOVENIA

Yamaha Music Europe GmbH, Branch Austria
Schleiergasse 20, 1100 Wien, Austria
Tel: +43-1-60203900

POLAND

**Yamaha Music Europe
Sp.z o.o. Oddział w Polsce**
ul. Młynarska 48, 01-171 Warszawa, Poland
Tel: +48-22-880-08-88

BULGARIA

Dinacord Bulgaria LTD.
Bul. Iskarsko Schose 7 Targowski Zentar
Ewropa 1528 Sofia, Bulgaria
Tel: +359-2-978-20-25

MALTA

Olimpus Music Ltd.
Valletta Road, Mosta MST9010, Malta
Tel: +356-2133-2093

NETHERLANDS/BELGIUM/ LUXEMBOURG

Yamaha Music Europe, Branch Benelux
Wattbaan 1 3439ML Nieuwegein,
The Netherlands
Tel: +31-347-358040

FRANCE

Yamaha Music Europe
7 rue Ambroise Croizat, Zone d'activités de
Pariest, 77183 Croissy-Beaubourg, France
Tel: +33-1-6461-4000

ITALY

Yamaha Music Europe GmbH, Branch Italy
Via Tinelli N.67/69 20855 Gerno di Lesmo (MB),
Italy
Tel: +39-039-9065-1

SPAIN/PORTUGAL

**Yamaha Music Europe GmbH Ibérica,
Sucursal en España**
Ctra. de la Coruña km. 17,200, 28231
Las Rozas de Madrid, Spain
Tel: +34-91-639-88-88

GREECE

Philippos Nakas S.A. The Music House
19th km. Leof. Lavriou 190 02 Peania – Attiki,
Greece
Tel: +30-210-6686260

SWEDEN

**Yamaha Music Europe GmbH Germany Filial
Scandinavia**
JA Wettergrensgata 1, 400 43 Göteborg, Sweden
Tel: +46-31-89-34-00

DENMARK

**Yamaha Music Denmark,
Filial of Yamaha Music Europe GmbH, Tyskland**
Generatorvej 8C, ST. TH., 2860 Søborg, Denmark
Tel: +45-44-92-49-00

FINLAND

F-Musiikki Oy
Antaksentie 4
FI-01510 Vantaa, Finland
Tel: +358 (0)96185111

NORWAY

**Yamaha Music Europe GmbH Germany -
Norwegian Branch**
c/o Box 30053, 400 43 Göteborg, Sweden
Tel: +47-6716-7800

ICELAND

Hjodfaerahusid Ehf.
Sidumula 20
IS-108 Reykjavik, Iceland
Tel: +354-625-5050

CYPRUS

Nakas Music Cyprus Ltd.
Nikis Ave 2k
1086 Nicosia
Tel: +357-22-511080
Major Music Center
21 Ali Riza Ave. Ortakoy
P.O.Box 475 Lefkoşa, Cyprus
Tel: (392) 227 9213

RUSSIA

Yamaha Music (Russia) LLC.
Room 37, entrance 7, bld. 7, Kievskaya street,
Moscow, 121059, Russia
Tel: +7-495-626-5005

OTHER EUROPEAN REGIONS

Yamaha Music Europe GmbH
Siemensstrasse 22-34, 25462 Rellingen, Germany
Tel: +49-4101-303-0

AFRICA

Yamaha Music Gulf FZE
JAFZA-16, Office 512, P.O.Box 17328,
Jebel Ali FZE, Dubai, UAE
Tel: +971-4-801-1500

MIDDLE EAST

TURKEY

Dore Muzik
Yeni Sütlü Sokak No. 10
Levent Istanbul / Türkiye
Tel: +90-212-236-3640
Fax: +90-212-259-5567

ISRAEL

RBX International Co., Ltd.
P.O.Box 10245, Petach-Tikva, 49002
Tel: (972) 3-925-6900

OTHER REGIONS

Yamaha Music Gulf FZE
JAFZA-16, Office 512, P.O.Box 17328,
Jebel Ali FZE, Dubai, UAE
Tel: +971-4-801-1500

ASIA

THE PEOPLE'S REPUBLIC OF CHINA

Yamaha Music & Electronics (China) Co., Ltd.
2F, Yunhedasha, 1818 Xinzha-lu, Jingan-qu,
Shanghai, China
Tel: +86-400-051-7700

HONG KONG

Tom Lee Music Co., Ltd.
11/F., Silvercord Tower 1, 30 Canton Road,
Tsimshatsui, Kowloon, Hong Kong
Tel: +852-2737-7688

INDIA

Yamaha Music India Private Limited
P-401, JMD Megapolis, Sector-48, Sohna Road,
Gurugram-122018, Haryana, India
Tel: +91-124-485-3300

INDONESIA

PT Yamaha Musik Indonesia Distributor
Yamaha Music Center Bldg. Jalan Jend. Gatot
Subroto Kav. 4, Jakarta 12930, Indonesia
Tel: +62-21-520-2577

KOREA

Yamaha Music Korea Ltd.
11F, Prudential Tower, 298, Gangnam-daero,
Gangnam-gu, Seoul, 06253, Korea
Tel: +82-2-3467-3300

MALAYSIA

Yamaha Music (Malaysia) Sdn. Bhd.
No.8, Jalan Perbandaran, Kelana Jaya, 47301
Petaling Jaya, Selangor, Malaysia
Tel: +60-3-78030900

SINGAPORE

Yamaha Music (Asia) Private Limited
Block 202 Hougang Street 21, #02-00,
Singapore 530202, Singapore
Tel: +65-6740-9200

TAIWAN

Yamaha Music & Electronics Taiwan Co., Ltd.
2F., No.1, Yuanhong Rd., Banqiao Dist.,
New Taipei City 22063, Taiwan (R.O.C.)
Tel: +886-2-7741-8888

THAILAND

Siam Music Yamaha Co., Ltd.
3, 4, 15, 16th Fl., Siam Motors Building,
89/1/1 Rama 1 Road, Wangmai,
Pathumwan, Bangkok 10330, Thailand
Tel: +66-2215-2622

VIETNAM

Yamaha Music Vietnam Company Limited
15th Floor, Nam A Bank Tower, 201-203 Cach
Mang Thang Tam St., Ward 4, Dist.3,
Ho Chi Minh City, Vietnam
Tel: +84-28-3818-1122

OTHER ASIAN REGIONS

<https://asia.yamaha.com/>

OCEANIA

AUSTRALIA

Yamaha Music Australia Pty. Ltd.
Level 1, 80 Market Street, South Melbourne,
VIC 3205 Australia
Tel: +61-3-9693-5111

NEW ZEALAND

Music Works LTD
P.O.BOX 6246 Wellesley, Auckland 4680,
New Zealand
Tel: +64-9-634-0099

REGIONS AND TRUST TERRITORIES IN PACIFIC OCEAN

<https://asia.yamaha.com/>

Yamaha Global Site

<https://www.yamaha.com/>

Yamaha Downloads

<https://download.yamaha.com/>

© 2023 Yamaha Corporation

Published 02/2023 MWMA-A0



VFT3090