

YAMAHA RX-350

Natural Sound Stereo Receiver

Ampli-sintoniseur stéréo de la série "Natural Sound"

Natural Sound Stereoreceiver

Natural Sound Stereoreceiver

Ricevitore stereo dal Suono Naturale

Receptor estéreo de Sonido Natural

CENTER

OWNER'S MANUAL
MODE D'EMPLOI
BEDIENUNGSANLEITUNG
BRUKSANVISNING
MANUALE DELL'UTENTE
MANUAL DE INSTRUCCIONES

**SUPPLIED ACCESSORIES
 ACCESSOIRES FOURNIS
 MITGELIEFERTE ZUBEHÖRTEILE
 MEDFÖLJANDE TILLBEHÖR
 ACCESSORI IN DOTAZIONE
 ACCESORIOS INCLUIDOS**

- After unpacking, check that the following parts are contained.
- Après le déballage, vérifier que les pièces suivantes sont incluses.
- Nach dem Auspacken überprüfen, ob die folgenden Teile vorhanden sind.
- Kontrollera efter det apparaten packats upp att följande delar finns med.
- Disimballato l'apparecchio, controllate di possedere tutte le parti menzionate.
- Desembale el aparato y verifique que los siguientes accesorios están en la caja.

- Indoor FM Antenna
- Antenne FM intérieure
- UKW-Innenantenne
- FM inomhusantenn
- Antenna FM per interni
- Antena FM interior

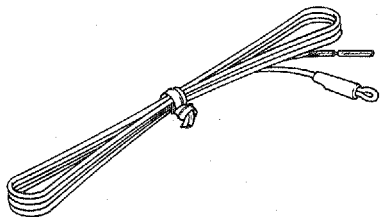

(U.S.A., Canada, U.K. and General models)
 (Modèles pour les Etas-Unis, le Canada, le Royaume-Uni et général)
 (USA-, Kanada-, Großbritannien- und allgemeines Modell)
 (Amerikansk, kanadensisk och brittisk modell)
 (Modelli per gli USA, il Canada, la GB e generale)
 (Modelos para EE.UU., Canadá, Reino Unido y general)

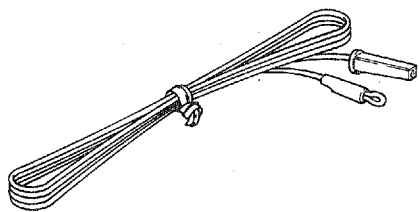

(Australia and Europe models)
 (Modèles pour l'Australie et l'Europe)
 (Australien- und Europa-Modell)
 (Australisk och europeisk modell)
 (Modelli per l'Australia e l'Europa)
 (Modelos Australia y Europa)

- AM Loop Antenna
- Antenne AM à boucle
- MW-Rahmenantenne
- AM ramantenn
- Antenna AM ad anello
- Antena de cuadro de AM

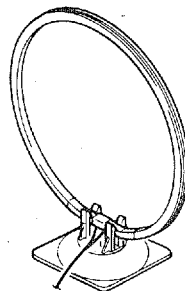

FEATURES

- 40W + 40W (8Ω) RMS Output Power, 0.04% THD, 20-20,000 Hz
- 16-Station Random Preset Tuning
- IF Count Direct PLL Synthesizer Tuning System
- Continuously Variable Loudness Control
- High Dynamic Power, Low Impedance Drive Capability
- CD Direct Switch
- Bass Extension Switch

CONTENTS

Supplied Accessories	2
Caution	3
Connections	4
Operations	6
Tuning Operations	8
Troubleshooting	10
Specifications	10

CAUTION: READ THIS BEFORE OPERATING YOUR UNIT.

1. To assure the finest performance, please read this manual carefully. Keep it in a safe place for future reference.
2. Install this unit in a cool, dry, clean place – away from windows, heat sources, and excessive vibration, dust, moisture or cold. Avoid sources of hum (transformers, motors). To prevent fire or electrical shock, do not expose the unit to rain or water.
3. Never open the cabinet. If something drops into the set, contact your dealer.
4. Do not use force on switches, controls or connection wires. When moving the unit, first disconnect the power plug and the wires connected to other equipment. Never pull the wire itself.
5. The openings on the cabinet assure proper ventilation of the amplifier. If these openings are obstructed, the temperature inside the cabinet will rise rapidly and eventually damage the circuits. Therefore, avoid placing objects against these openings and do not install the amplifier where the flow of air through the ventilation openings could be impeded.
6. Always set the VOLUME control to “-∞” before starting the audio source play: increase the volume gradually to an appropriate level after the play is started.
7. Do not attempt to clean the unit with chemical solvents; this might damage the finish. Use a clean, dry cloth.
8. Be sure to read the “TROUBLESHOOTING” section regarding common operating errors before concluding that the unit is faulty.
9. To prevent lightning damage, disconnect the power cord’s plug cord and disconnect the antenna cable when there is an electrical storm.
10. Grounding or polarization – The precautions should be taken so that the grounding or polarization of an appliance is not defeated.
11. AC outlet (U.S.A., Canada and General models)
Do not connect audio equipment to the AC outlet on the rear panel if that equipment requires more power than the outlet is rated to provide.
12. Voltage Selector (General Model only)
The voltage selector on the rear panel of this unit must be set for your local mains voltage BEFORE plugging into the AC mains supply.
Voltages are 110/120/220/240 V AC, 50/60 Hz.

IMPORTANT

Please record the serial number of this unit in the space below.

Serial No.:

The serial number is located on the rear of the unit. Retain this Owner’s Manual in a safe place for future reference.

WARNING

TO REDUCE THE RISK OF FIRE OR ELECTRIC SHOCK, DO NOT EXPOSE THIS APPLIANCE TO RAIN OR MOISTURE.

CAUTION (FOR CANADA MODEL)

TO PREVENT ELECTRIC SHOCK DO NOT USE THIS (POLARIZED) PLUG WITH AN EXTENSION CORD RECEPTACLE OR OTHER OUTLET UNLESS THE BLADES CAN BE FULLY INSERTED TO PREVENT BLADE EXPOSURE.

FOR CANADIAN CUSTOMER

THIS DIGITAL APPARATUS DOES NOT EXCEED THE “CLASS B” LIMITS FOR RADIO NOISE EMISSIONS FROM DIGITAL APPARATUS SET OUT IN THE RADIO INTERFERENCE REGULATION OF THE CANADIAN DEPARTMENT OF COMMUNICATIONS.

Special Instructions for U.K. Model

IMPORTANT

THE WIRES IN THE MAINS LEAD ARE COLOURED IN ACCORDANCE WITH THE FOLLOWING CODE:

Blue: NEUTRAL
Brown: LIVE

As the colours of the wires in the mains lead of this apparatus may not correspond with the coloured markings identifying the terminals in your plug, proceed as follows:

The wire which is coloured BLUE must be connected to the terminal which is marked with the letter N or coloured BLACK. The wire which is coloured BROWN must be connected to the terminal which is marked with the letter L or coloured RED.

FREQUENCY STEP switch (General Model only)

Because the interstation frequency spacing differs in different areas, set the FREQUENCY STEP switch (located at the rear) according to the frequency spacing in your area.

CONNECTIONS

Before attempting to make any connections to or from this unit, be sure to first switch OFF the power to this unit and to any other components to which connections are being made.

AUDIO CONNECTIONS

When making connections between this unit and other components, be sure all connections are made correctly, that is to say L (left) to L, R (right) to R, "+" to "+" and "-" to "-". Also, refer to the owner's manual for each component to be connected to this unit.

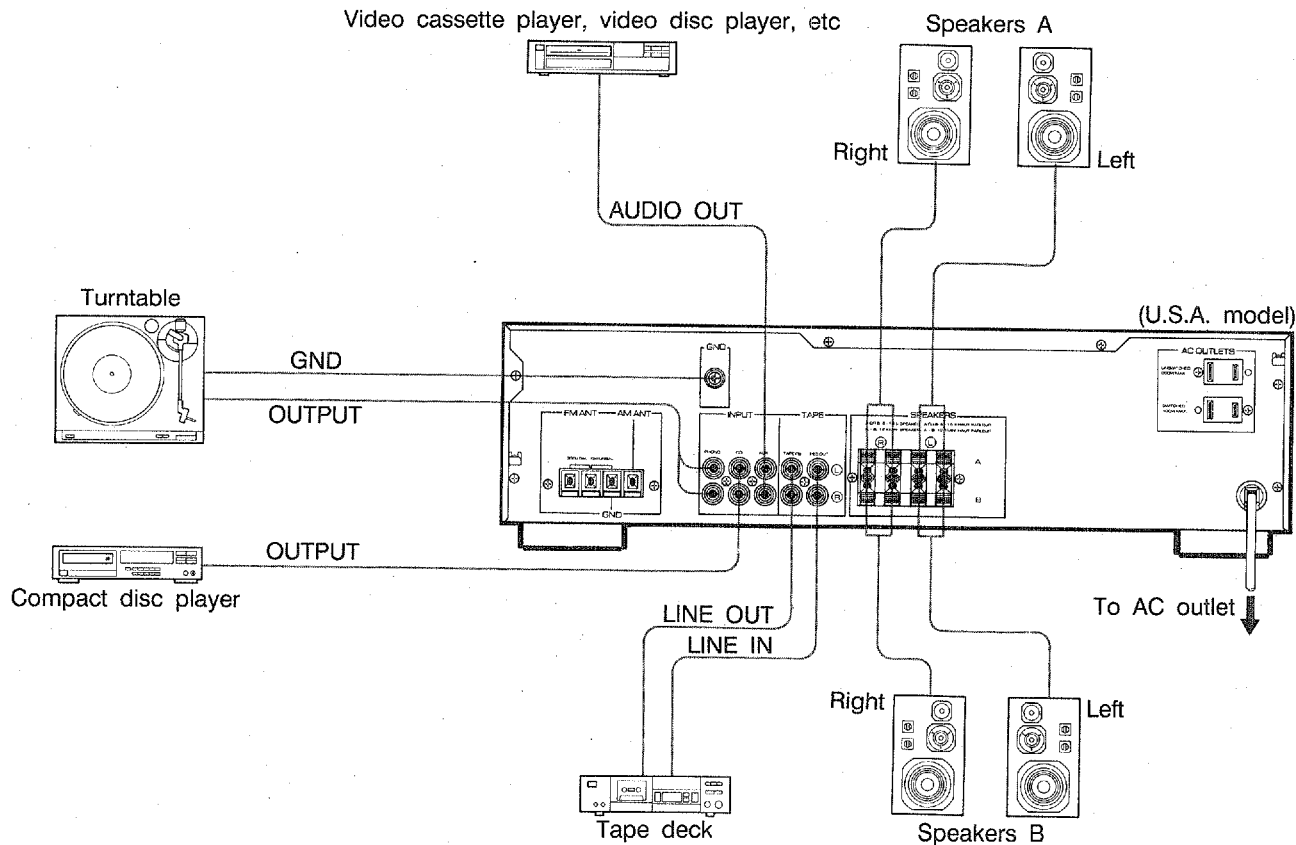

Connecting speaker systems

- One or two speaker systems can be connected to this unit. If you connect only one speaker system, connect it to either **SPEAKERS A** or **B** terminals.
- **How to Connect:**
Connect the **SPEAKERS** terminals to your speakers with wire of the proper gauge, cut to be as short as possible. Press and hold the **SPEAKERS** terminal tabs, then insert the bare wires and secure them by releasing the tabs. If these connections are faulty, no sound will be heard from the speakers. Make sure that the polarity of the speaker wires is correct, that is, + and - markings are observed. If these wires are reversed, the sound will be unnatural and will lack bass. Do not let the bare speaker wires touch each other as this could damage this unit and/or speakers.

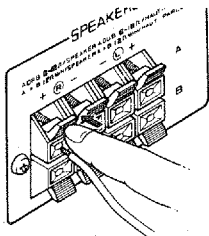

About the accessory terminals

- **AC OUTLETS**
(U.S.A., Canada and General models)
Use these to connect the power cords from your components to this unit.
The power to the **SWITCHED** outlets is controlled by this unit's **POWER** switch. They will supply power to any component whenever this unit is turned on.
The power to the **UNSWITCHED** outlet is not controlled by this unit. It will continually supply power to any unit connected.
The maximum power (total power consumption of components) that can be connected to the **SWITCHED AC OUTLET** is 100 watts and to the **UNSWITCHED AC OUTLET** is 200 watts.
- **GND terminal**
Connecting the ground wire of the turntable to this terminal will produce minimum hum, but in some cases better results may be obtained with the ground wire disconnected.

ANTENNA CONNECTIONS

- Each antenna should be connected to the designated terminals correctly, referring to the following figure.
- Both AM and FM indoor antennas are included with this unit. In general, these antennas will probably provide sufficient sensitivity. Furthermore, a properly installed outdoor antenna will give clearer reception than an indoor one. If you experience poor reception quality, an outdoor antenna may result in improvement.

U.S.A., CANADA, U.K. AND GENERAL MODELS

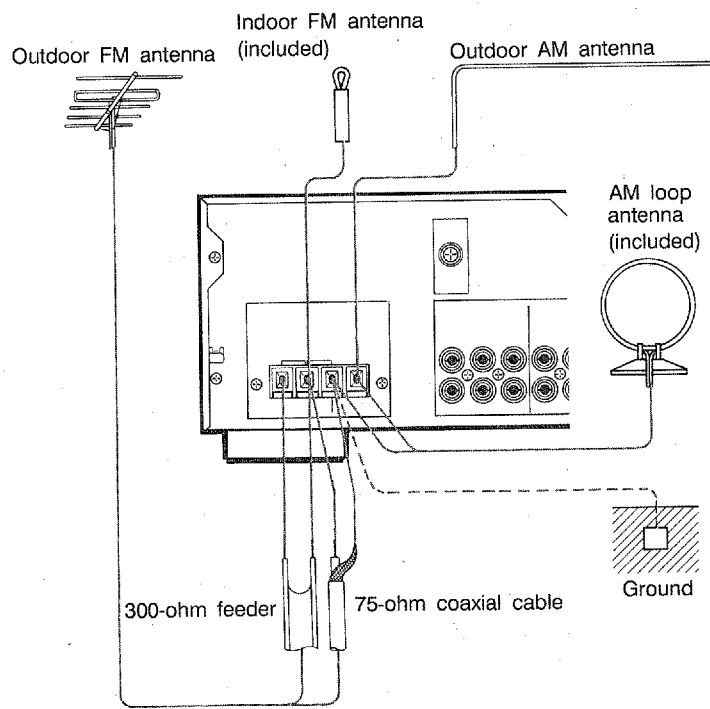

AUSTRALIA AND EUROPE MODELS

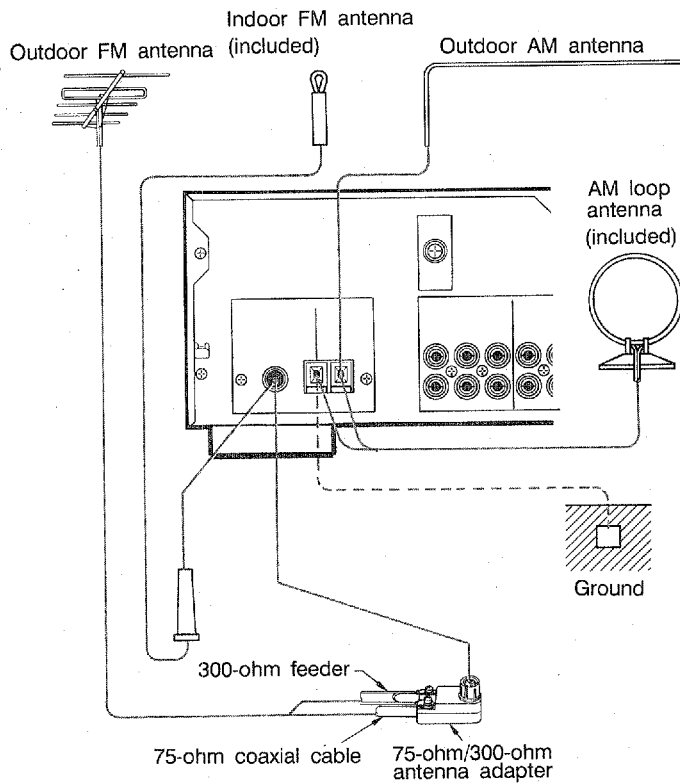

Connecting the AM loop antenna

1

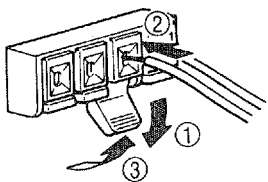

2

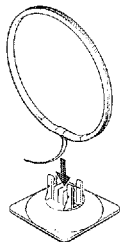

3

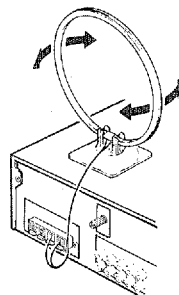

Orient so that the best reception is obtained.

- * The antenna may be hung on a wall.
- * The AM loop antenna should be kept being connected, even if an outdoor AM antenna is connected to this unit.

GND terminal

For maximum safety and minimum interference, connect the **GND** terminal to a good earth ground if practical. A good earth ground is a metal stake driven into moist earth.

Notes

- When connecting the indoor FM antenna (for Australia and Europe model), make sure that the grooved part of the connector hole is facing downward.
- If you need an outdoor FM antenna to improve FM reception quality, either 300-ohm feeder or coaxial cable may be used. In locations troubled by electrical interference, coaxial cable is preferable.

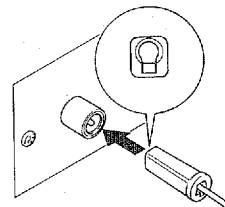

OPERATIONS

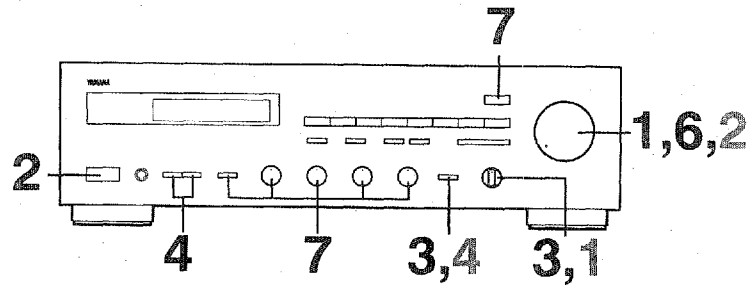

To listen to an audio source

- 1**

VOLUME

Set to the “-∞” position.
- 2**

POWER
- 3** Select the source you want to listen to.

INPUT

* If you want to listen to a sound from the tape deck;

TAPE MONITOR

(When not listening to a sound from the tape deck, always set to the “SOURCE” position.)
- 4** Select the speaker systems to be used by pressing the **SPEAKERS** switches. (Refer to the next page for details.)
- 5** Play the source.

- 6**

VOLUME

Adjust to the desired output level.
- 7** If desired, adjust the **BALANCE, BASS, TREBLE, LOUDNESS** controls and the **BASS EXTENSION** switch. (Refer to the next page for details.)

To record a source to audio tape

- 1** Select the source to be recorded.

INPUT
- 2** Play the source and then turn the **VOLUME** control up to confirm the input source.
- 3** Set the tape deck in the recording mode.
- 4** If your tape deck has three head monitoring capability you can monitor the just recorded signal.

TAPE MONITOR

Note

Adjusting the **VOLUME, LOUDNESS, BASS, TREBLE** and **BALANCE** controls during recording has no effect on the material being recorded.

Adjusting the BALANCE control

Adjust the balance of the output volume on the left and right speakers to compensate for sound imbalance caused from speaker settings or listening room condition.

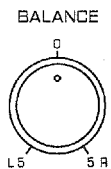

Selecting the SPEAKER systems

Because one or two speaker systems can be connected to this unit, the **SPEAKERS** switches allow you to select speaker systems A or B, or both at once.

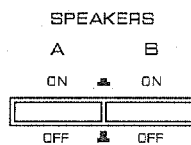

Adjusting the BASS and TREBLE controls

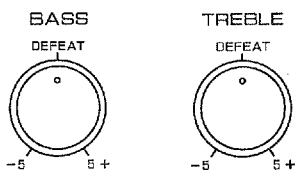

BASS : Turn this clockwise to increase (or counter-clockwise to decrease) the low frequency response.

TREBLE : Turn this clockwise to increase (or counter-clockwise to decrease) the high frequency response.

Adjusting the continuous variable LOUDNESS control

This control provides compensation for the human ears' loss of sensitivity to high and low-frequency ranges at low volume. This control is adjustable to retain full tonal range at any volume levels.

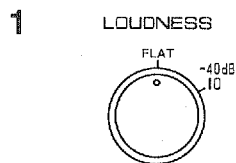

Set to the "FLAT" position.

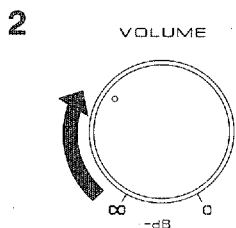

Set to your loudest listening level.

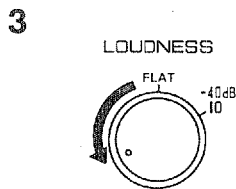

Turn until the volume level is reduced to a desired level without losing natural tone.

Using the BASS EXTENSION switch

You can boost bass frequency response by setting this switch to the "ON" position.



When you listen with headphones

Connect the headphones to the **PHONES** jack. When listening with headphones privately, set both the **SPEAKERS A** and **B** switches to the OFF position.



Using the CD DIRECT switch

You can enjoy purer CD sound by setting this switch to the "ON" position. Because, by doing so, the CD input signal is output directly, bypassing the **LOUDNESS**, **BALANCE** control, etc. therefore avoiding any "muddying" caused by circuit routing.

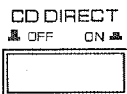

TUNING OPERATIONS

Normally, if station signals are strong and there is no interference, quick automatic-search tuning is possible. However, if signals of the station you want to select are weak, you must tune to it manually.

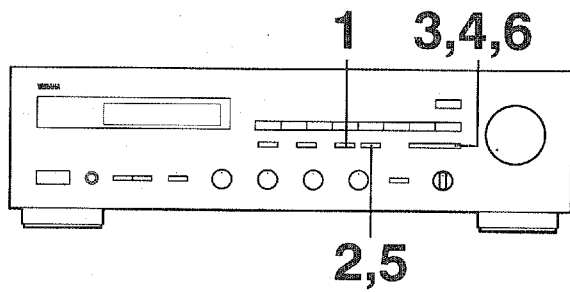

1 Select the reception band (FM or AM) while watching the display.

2

3

4 If the station where tuning search stopped is not the desired one, press again.

5 If the tuning search does not stop at the desired station;

6

* You can tune to the desired station manually.

* To continue tuning search, press and hold the button.

Display information

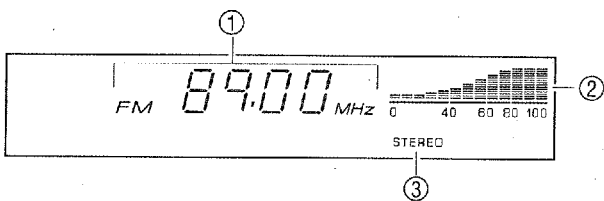

- ① Displays the band and frequency of the received station.
- ② Indicates the signal level of the received station.
- ③ Illuminates when an FM stereo broadcast with sufficient signal strength is received.

Note

If you tune to a FM station manually, it is received in monaural automatically to increase the signal quality.

PRESET TUNING

This unit can store station frequencies (selected by tuning operation) by using preset station buttons. By this function, you can select any desired station by only pressing the corresponding preset station button. Up to 16 stations can be programmed.

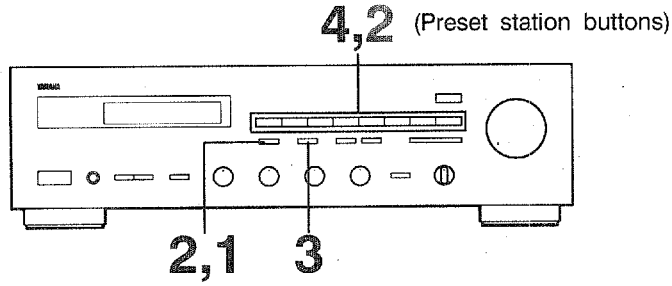

To program stations

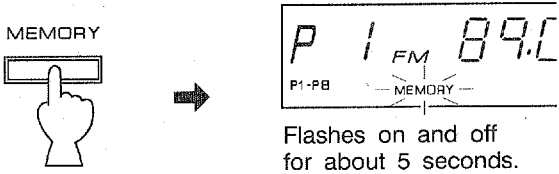
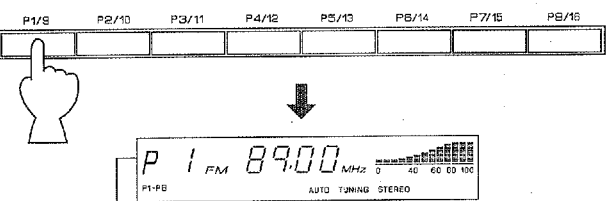
- 1 Tune to a desired station.
(Refer to the previous page for tuning procedures.)
- 2 Select the range (P1-8 or P9-16) of the preset station buttons while watching the display.
P1-8/P9-16

- 3  **MEMORY**
Flashes on and off for about 5 seconds.
- 4  Shows the displayed station has been programmed to P1.

* In the same way, program other stations to P2, P3 ... P8.
* To program stations to P9, P10 ... P16, in step 2, "P9-P16" should be illuminated in the display.

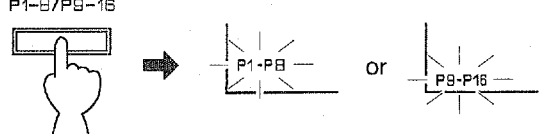
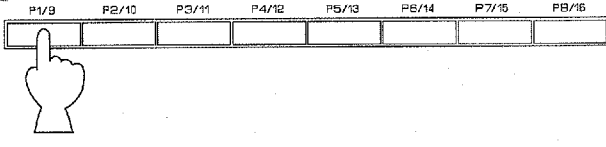
To recall a preset station

- 1 Select the range of the preset station buttons.
P1-8/P9-16

- 2  Select the desired one.

Notes

- In step 4, press a preset station button before "MEMORY" goes off from the display.
- A new setting can be programmed in place of the former one.
- For presets, the setting of the reception mode (stereo or monaural) is stored along with the station frequency.

Memory back-up

The memory back-up circuit prevents the programmed data from being lost even if the power is switched OFF (for timer use or due to temporary power failure). If, however, the unit is not used for a long time, the memory may be erased. If so, it can be re-programmed by simply following the PRESET TUNING steps.

TROUBLESHOOTING

If the unit fails to operate normally, check the following points to determine whether the fault can be corrected by the simple measures suggested. If it cannot be corrected, or if the fault is not listed in the SYMPTOM column, disconnect the power cord and contact your dealer or service center for help.

	SYMPTOM	CAUSE	REMEDY
Amplifier	The receiver fails to turn on when the POWER switch is pressed.	Power cord is not plugged in or is not completely inserted.	Firmly plug in the power cord.
	No sound.	Incorrect output cord connections.	Connect cord properly. If the problem persists, the cables may be defective.
	Sound "hums".	Incorrect receiver operation.	Set the receiver controls to the correct input selection.
FM	FM stereo reception is noisy.	Because of the characteristics of FM stereo broadcasts, this is limited to cases where the transmitter is far away or the antenna input is poor.	Firmly connect the audio plugs. If the problem persists, the cord may be defective.
	There is distortion and clear reception cannot be obtained even with a good FM antenna.	There is multipath interference.	Check the antenna connections. Try using a multiple element FM antenna.
	A desired station cannot be tuned in with Auto tuning.	The station is too weak.	Adjust antenna placement to eliminate multipath interference.
AM	A desired station cannot be tuned in with Auto tuning.	Weak signal or loose antenna connections.	Use Manual tuning mode. Use high quality directional FM antenna.
	There are continuous crackling and hissing noises.	These noise result from lightning, fluorescent lamps, motors, thermostats and other electrical equipment.	Tighten the AM loop antenna connections and rotate it for best reception. Use Manual tuning mode.
	There are buzzing and whining noises (especially in the evening).	A television set is being used nearby.	Use an outdoor antenna and a ground wire. This will help some what but it is difficult to eliminate all noise.
			Move the television away.

SPECIFICATIONS

AUDIO SECTION

Minimum RMS Output Power per Channel	
8 ohms, 20 Hz to 20 kHz, 0.04% THD	
[U.S.A., Canada and General models]	40 W
[Australia, Europe and U.K. models]	35 W
6 ohms, 20 Hz to 20 kHz, 0.06% THD	
[U.S.A., Canada and General models]	42 W
[Australia, Europe and U.K. models]	40 W
4 ohms, 20 Hz to 20 kHz, 0.1% THD	
[Canada model only]	48 W
Dynamic Power per Channel (IHF)	
8/6/4/2 ohms	
[U.S.A., Canada and General models]	67/78/95/88 W
[Australia, Europe and U.K. models]	60/70/80/82 W
DIN Standard Output Power per Channel	
4 ohms, 1 kHz, 1% THD	
[Europe model only]	47 W
IEC Power (1 kHz, 0.04% THD, 8/6 ohms)	
[Europe model only]	45/48 W
Power Band Width	
8 ohms, 20 W, 0.1% THD	10 Hz to 40 kHz
Damping Factor	
8 ohms, 1 kHz	50 or more
Input Sensitivity/Impedance	
PHONO	2.5 mV/47 k-ohms
CD/TAPE/VIDEO/AUX	150 mV/50 k-ohms
Maximum Input Signal Level (1 kHz, 0.01% THD)	
PHONO	120 mV
Output Level/Impedance	
REC OUT	150 mV/100 ohms
Headphone Jack Rated Output/Impedance	
	0.55 V/ 8 ohms
Frequency Response (20 Hz to 20 kHz)	
CD/TAPE/VIDEO/AUX	±0.5 dB
RIAA Equalization Deviation (20 Hz to 20 kHz)	
PHONO	±0.5 dB
Total Harmonic Distortion (20 Hz to 20 kHz)	
PHONO to REC OUT (3 V)	0.01%
CD/TAPE/VIDEO/AUX to SP OUT (20 W/8 ohms)	0.02%
Intermodulation Distortion	
CD/TAPE/VIDEO/AUX (Rated Output/8 ohms)	0.04%
Signal-to-Noise Ratio (IHF-A Network)	
PHONO (5 mV Input Shorted)	
[U.S.A., Canada and General models]	87 dB
[Australia, Europe and U.K. models]	82 dB
CD/TAPE/VIDEO/AUX (Shorted)	103 dB
Residual Noise (IHF-A Network)	140 µV
Channel Separation (1 kHz, Vol. -30 dB)	
PHONO (Input Shorted)	55 dB
CD/TAPE/VIDEO/AUX	
(Input 5.1 k-ohms Terminated)	52 dB

Tone Control Characteristics

BASS : Boost/cut	±10 dB (50 Hz)
Turnover Frequency	350 Hz
TREBLE : Boost/cut	±10 dB (20 kHz)
Turnover Frequency	3.5 kHz
Filter Characteristics	
Bass Extension	60 Hz, 8 dB
Continuous Loudness Control	-40 dB (1 kHz)
	(Level related equalization)

FM SECTION

Tuning Range	
[U.S.A., Canada and General models]	87.5 to 107.9 MHz
[Australia, Europe, U.K. and General models]	87.5 to 108.0 MHz
50 dB Quieting Sensitivity (IHF, 75 ohms)	
[Except Europe model]	
Mono	1.55 µV (15.1 dBf)
Stereo	21 µV (37.7 dBf)
Usable Sensitivity (75 ohms)	
(30 dB S/N Quieting, 1 kHz, 100% mod.)	
[Except Europe model]	0.8 µV (9.3 dBf)
DIN, Mono (S/N 26 dB) [Europe model]	0.9 µV
DIN, Stereo (S/N 46 dB) [Europe model]	24 µV
Image Response Ratio	
[Except Europe model]	45 dB
[Europe model]	80 dB
IF Response Ratio	80 dB
Spurious Response Ratio	70 dB
AM Suppression Ratio	55 dB
Capture Ratio	1.5 dB
Alternate Channel Selectivity	
[Except Europe model]	85 dB
Selectivity (two signals, 40 kHz Dev.)	
[Europe model]	50 dB
Signal-to-Noise Ratio	
(IHF) Mono/Stereo	
[Except Europe model]	81/76 dB
(DIN-weighted, 40 kHz Dev.) Mono/Stereo	
[Europe model]	75/70 dB
Harmonic Distortion (1 kHz)	
Mono/Stereo	
[Except Europe model]	0.1/0.2%
Stereo (40 kHz Dev.)	
[Europe model]	0.2%

Frequency Response

30 Hz to 13 kHz	0±0.5 dB
20 Hz to 15 kHz	0±1.5 dB
Stereo Separation (1 kHz)	
[Except Europe model]	50 dB
[Europe model (40 kHz Dev.)]	50 dB

AM SECTION

Tuning Range	
[U.S.A., Canada and General models]	530 to 1,610 kHz
[Australia, Europe, U.K. and General models]	531 to 1,611 kHz
Usable Sensitivity	100 µV/m
Selectivity	32 dB
Signal-to-Noise Ratio	50 dB
Image Response Ratio	40 dB
Spurious Response Ratio	50 dB
Harmonic Distortion (400 Hz)	0.3%

AUDIO SECTION

Output Level/Impedance	
FM (100% mod., 1 kHz)	
[Except Europe model]	500 mV/2.2 k-ohms
[Europe model (40 kHz Dev.)]	400 mV/6.8 k-ohms
AM (30% mod., 400 Hz)	
[Except Europe model]	150 mV/2.2 k-ohms
[Europe model (40 kHz Dev.)]	150 mV/6.8 k-ohms

GENERAL

Power Supply	
[U.S.A. and Canada models]	AC 120 V, 60 Hz
[Australia and U.K. models]	AC 240 V, 50 Hz
[Europe model]	AC 220 V, 50 Hz
[General model]	AC 110/120/220/240 V, 60/50 Hz
Power Consumption	
[U.S.A., Canada and General models]	145 W
[Australia, Europe and U.K. models]	120 W
AC Outlets	
[U.S.A., Canada and General models only]	
Switched	100 W max.
Unswitched	200 W max.
Dimensions (W x H x D)	435 x 131 x 292 mm
	(17-1/8" x 5-3/16" x 11-1/2")
Weight	5.2 kg (11 lbs. 7 oz.)
Accessories	AM loop antenna x 1
	Indoor FM antenna x 1

Specifications subject to change without notice.

YAMAHA

YAMAHA ELECTRONICS CORPORATION, USA 6722 ORANGETHORPE AVE., BUENA PARK, CALIF. 90620, U.S.A.
YAMAHA CANADA MUSIC LTD. 135 MILNER AVE., SCARBOROUGH, ONTARIO M1S 3R1, CANADA
YAMAHA ELECTRONIK EUROPA G.m.b.H. 2064 RELINGEN, BEI HAMBURG, SIEMENSSTR. 22/34, F.R. OF GERMANY
YAMAHA ELECTRONIQUE FRANCE S.A. 17 RUE DES CAMPANULES, LOGNES 77321 MARNE LA VALLEE CEDEX 2, FRANCE
YAMAHA ELECTRONICS (UK) LTD. YAMAHA HOUSE, 200 RICKMANSWORTH ROAD WATFORD, HERTS WD1 7JS, ENGLAND
YAMAHA SCANDINAVIA A.B. J A WETTERGRENS GATA 1, BOX 30053, 400 43 VÄSTRA FRÖLUNDA, SWEDEN
YAMAHA MUSIC AUSTRALIA PTY, LTD. 17-33 MARKET ST., SOUTH MELBOURNE, 3205 VIC., AUSTRALIA

YAMAHA CORPORATION
10-1 NAKAZAWA-CHO HAMAMATSU JAPAN
VJ49850-0 BWB2.b   Printed in Japan