

YAMAHA

PORTATONE

PSR-100

Owner's Guide
Bedienungsanleitung
Mode d'emploi
Guía del propietario

Congratulations!

Thank you for choosing a Yamaha PortaTone PSR-100. Your PSR-100 is a high-performance electronic keyboard that features the most advanced Yamaha technology for superior sound and features. To ensure that you fully understand the many fine features provided, we urge you to follow the steps outlined in this manual while actually trying out the instrument's features.

Herzlichen Glückwunsch

Herzlichen Dank für den Kauf des Yamaha PortaTone PSR-100. Ihr PortaTone ist ein leistungsstarkes elektronisches Keyboard, das dank modernster Yamaha Musiktechnologie überlegenen Klang und vielseitige Einsatzmöglichkeiten bietet. Um das großartige Potential des PortaTone voll ausschöpfen zu können und sich gut mit seinen Funktionen vertraut zu machen, sollten Sie sich beim anfänglichen Spielen auf dem Instrument nach den Bedienschritten in dieser Anleitung richten.

Félicitations!

Nous vous remercions d'avoir porté votre choix sur le PortaTone Yamaha PSR-100. Le PSR-100 est un clavier électronique, produit de la technologie Yamaha la plus perfectionnée, vous offrant des fonctions et une qualité sonore remarquables. Afin de parfaitement comprendre toutes les fonctions de cet instrument, nous vous conseillons de lire très attentivement ce mode d'emploi tout en essayant les fonctions qui y sont décrites.

¡Enhorabuena!

Muchas gracias por comprar el PortaTone PSR-100 de Yamaha. Su PSR-100 es un teclado electrónico de gran rendimiento que caracteriza la tecnología más avanzada de Yamaha para un sonido y características superiores. Para asegurarse de que entiende totalmente las muchas características con las que se proporciona, le sugerimos que siga los pasos descritos en este manual mientras prueba las características de los instrumentos.

CONTENTS

Taking Care of Your PortaTone	1	Automatic Playback of the Demo Tune	3
Power Supply	1	Playing in the Harmony Mode	3
Using Batteries	1	Selecting Voices	4
Using An Optional Power Adaptor	1	Adjusting the Volume	4
Setting Up & Removing the Music Stand	1	Playing a Rhythm Pattern	4
Using Headphones or an External Sound System	1	Adjusting the Tempo (speed) of the Rhythm Pattern	4
Optional Accessories	1	Automatic Accompaniment	5
Nomenclature	2	SINGLE FINGER Mode	5
Top Panel Controls	2	FINGERED Mode	5
Rear Panel Connectors	3	Automatic Ad-Lib Phrases	5
Playing the PSR-100	3	Song Accompaniment	6
		Troubleshooting	6
		Specifications	6

INHALT

Behandlung Ihres PortaTone	7	Automatische Wiedergabe des Demostückes	9
Stromversorgung	7	Spielen in der HARMONY-Betriebsart	9
Stromversorgung über Batterien	7	Klangwahl	10
Stromversorgung über Netzadapter	7	Lautstärkeregelung	10
Anbringen und Abnehmen des Notenständers	7	Spielen mit Schlagzeugbegleitung	10
Verwendung von Kopfhörer oder externem Verstärkersystem	7	Einstellung des Rhythmustempos	10
Sonderzubehör	7	Automatische Begleitung	11
Bezeichnung der Teile	8	SINGLE FINGER-Betriebsart	11
Bedienfeld	8	FINGERED-Betriebsart	11
Anschlüsse auf der Rückseite	9	Phrasenautomatik	11
Spielen auf dem PSR-100	9	Songbegleitung	12
		Fehlersuche	12
		Technische Daten	12

TABLE DES MATIERES

Entretien du PortaTone	13	Reproduction de la mélodie de démonstration	15
Alimentation électrique	13	Jouez en mode harmonie	15
Fonctionnement sur piles	13	Sélection des voix	16
Utilisation d'un adaptateur secteur en option	13	Réglage du volume	16
Montage et retrait du pupitre	13	Reproduction d'un pattern rythmique	16
Utilisation d'un casque d'écoute ou d'un système de sonorisation externe	13	Réglage du tempo (vitesse) des patterns rythmiques	16
Accessoires en option	13	Accompagnement automatique	17
Nomenclature	14	Mode SINGLE FINGER	17
Commandes du panneau supérieur	14	Mode FINGERED	17
Connecteurs du panneau arrière	15	Phrases Ad-Lib automatiques	17
Jouez du PSR-100	15	Accompagnement de morceaux	18
		Dépistage des pannes	18
		Spécifications	18

INDICE

Cuidados de su PortaTone	19	canción de demostración	21
Alimentación	19	Tocando con el modo de armonía	21
Uso de pilas	19	Selección de voces	22
Uso del adaptador de alimentación opcional	19	Ajuste del volumen	22
Colocación y extracción del atril	19	Tocando un patrón rítmico	22
Uso de auriculares o un sistema de sonido exterior	19	Ajuste del tempo (velocidad) del patrón rítmico	22
Accesorios opcionales	19	Acompañamiento automático	23
Nomenclatura	20	Modo SINGLE FINGER	23
Controles del panel superior	20	Modo FINGERED	23
Conectores del panel posterior	21	Frases de improvisación automáticas	23
Tocando con el PSR-100	21	Acompañamiento de canción	24
Reproducción automática de la		Localización y reparación de averías	24
		Especificaciones	24

Taking Care of Your PortaTone

Your PortaTone will give you years of playing pleasure if you follow the simple rules given below:

1. Avoid placing the PortaTone in areas that are subject to excessive humidity or heat. Do not leave the instrument near heaters or in a car exposed to direct sunlight, for example.
2. Avoid locations in which the instrument is likely to be exposed to excessive dust or moisture.
3. Connections between the PortaTone and any other device must be made with both pieces of equipment turned OFF.
4. Do not subject the instrument to strong physical shocks, and avoid placing heavy objects on it.
5. Use a soft cloth, dry or slightly damp, for cleaning. Never use chemicals such as benzine or thinner.
6. Since the PortaTone contains digital circuitry, it may cause interference if placed to close to radio or television receivers. If this occurs, move the instrument further away from the affected equipment.

Power Supply

Your PSR-100 will run either from optional batteries or an optional power adaptor. Follow the instructions below according to the power source you intend to use.

Using Batteries

Six 1.5V D size (SUM-1 or R-20) or equivalent alkaline batteries (sold separately) must first be installed in the battery compartment.

1. Open the battery compartment cover located on the instrument's bottom panel.
2. Insert the six batteries, being careful to follow the polarity markings on the cabinet.
3. Replace the compartment cover, making sure that it locks firmly in place.

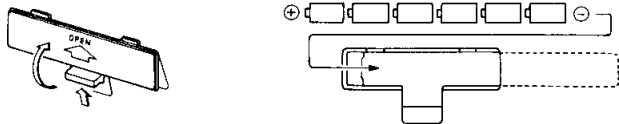

* The included batteries are for testing purposes. Their service life might be considerably shortened due to storage conditions, etc.

Caution:

1. When the batteries run down, replace them with a complete set of six new batteries. NEVER mix old and new batteries.
2. To prevent possible damage due to battery leakage, remove the batteries from the instrument if it is not to be used for an extended period of time.

Using An Optional Power Adaptor

Plug the DC output cable from an optional PA-1, PA-1B or PA-3 Power Adaptor into the DC(9-12V)IN jack on the rear panel, then plug the adaptor into a convenient wall AC power socket.

DC 9-12V IN



Use ONLY a Yamaha PA-1, PA-1B or PA-3 Power Adaptor to power your instrument from the AC mains. Attempting to use other AC adaptors could result in serious damage to your PSR-100.

Setting Up & Removing the Music Stand

The PSR-100 is supplied with a music stand that can be mounted on the instrument by fitting the bottom edge of the stand into the groove on the top of the control panel of the instrument.

To remove the music stand, lift it up and out.

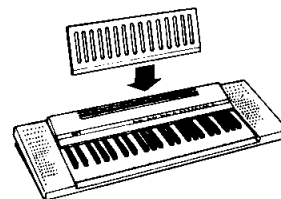

Using Headphones or an External Sound System

The Rear-panel HEADPHONES/AUX.OUT Jack

A standard pair of stereo headphones can be plugged in here for private practice or late-night playing. The internal speaker system is automatically shut off when a pair of headphones is plugged into the HEADPHONES/AUX.OUT jack.

The HEADPHONES/AUX.OUT jack can also be used to deliver the output of the PSR-100 to a keyboard amplifier, stereo sound system, mixing console or tape recorder. Use the optional Yamaha connecting cord to connect the HEADPHONES/AUX.OUT jack to your sound system.

HEADPHONES/
AUX. OUT



Optional Accessories

- AC Power Adaptor (PA-1/PA-1B/PA-3)
- Headphones (HPE-3/HPE-5)
- Stand (L-2/L-4)
- Bench (BC-6)
- Stereo Connection Cord (PSC-3)
Use this cord to connect your PSR-100 to a stereo hi-fi system.
- Stereo Conversion Plug (PCP-1)
Converts stereo pin jacks to a stereo phone plug.

* Some optional accessories may not be available in all areas.

Nomenclature

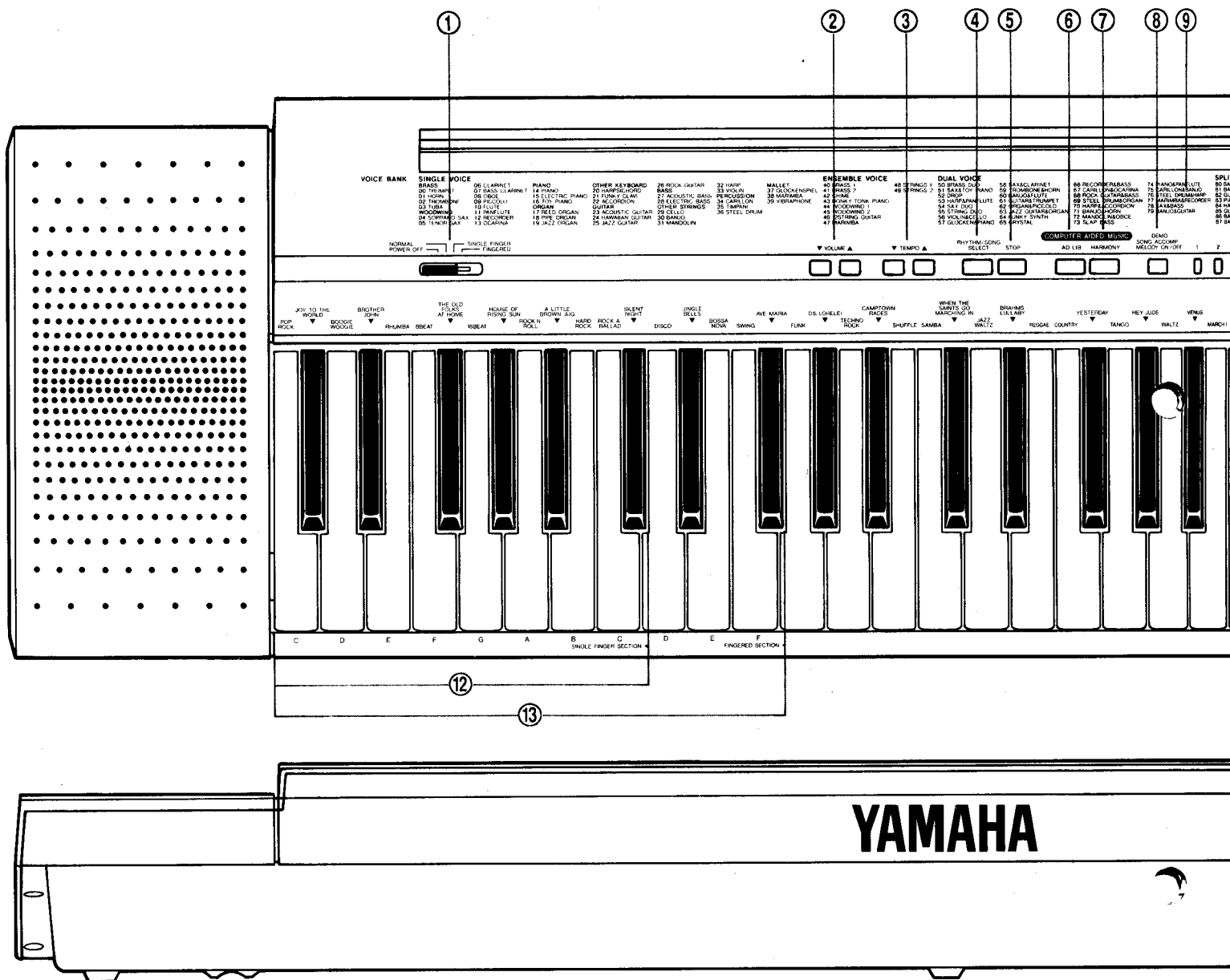

Top Panel Controls

- ① POWER/MODE Switch page 3 and 5
- ② VOLUME Buttons page 4
- ③ TEMPO Buttons page 4
- ④ RHYTHM/SONG SELECT Button page 4 and 6
- ⑤ STOP Button page 3, 4 and 6
- ⑥ AD-LIB Button page 5
- ⑦ HARMONY Button page 3

- ⑧ DEMO (SONG ACCOMP. MELODY ON/OFF) Button page 3 and 6
- ⑨ VOICE BANK List page 4
- ⑩ VOICE SELECT Buttons page 4
- ⑪ ENTER Button page 4
- ⑫ SINGLE FINGER Section page 5
- ⑬ FINGERED Section page 5

Playing the PSR-100

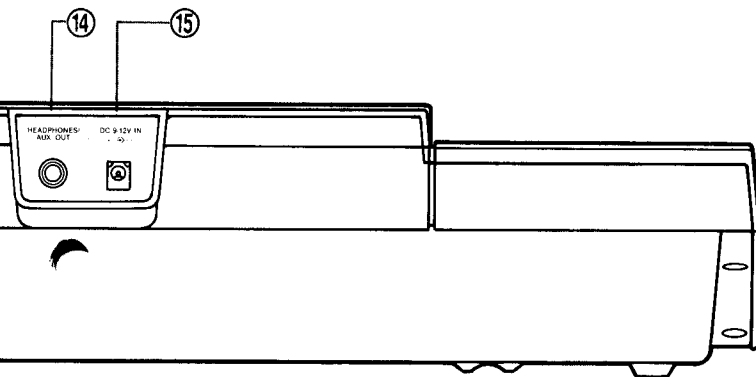
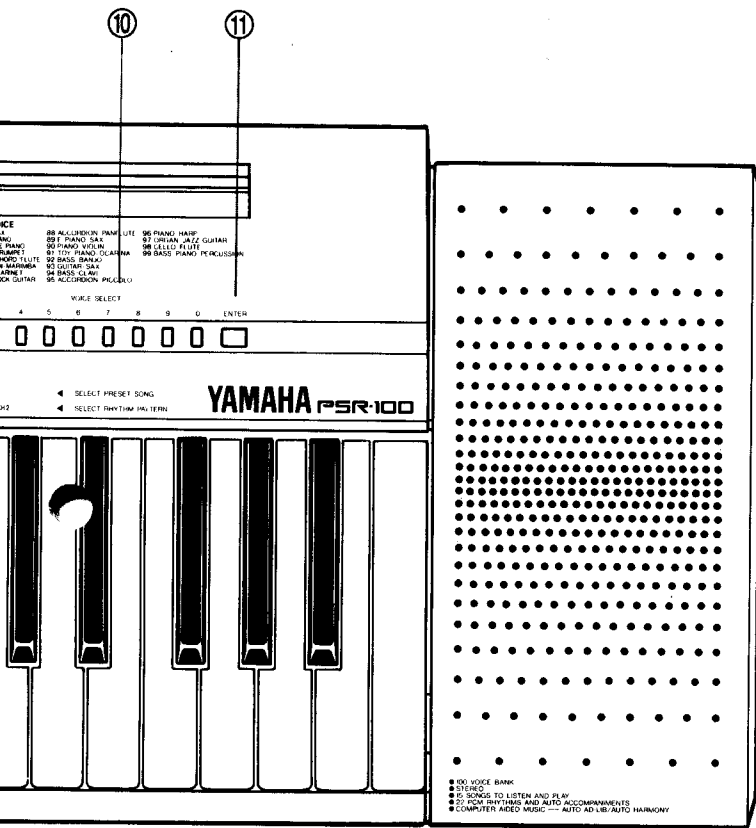

Rear Panel Connectors

- ⑭ HEADPHONES/AUX. OUT Jack page 1
- ⑮ DC(9-12V)IN Jack page 1

Automatic Playback of the Demo Tune

Slide the [POWER/MODE] switch to the **NORMAL** position, and press the [DEMO] button.

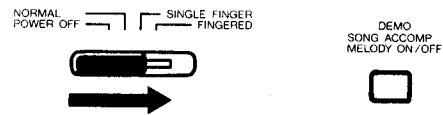

The demo tune will continue playing until you press the [STOP] or [DEMO] button.



- Tempo and volume can be varied while the demo tune is playing.

Playing in the Harmony Mode

When the PSR-100 is initially turned ON, voice number 00 (TRUMPET) is automatically selected and the **HARMONY** mode is turned OFF.

The **HARMONY** mode can be turned ON or OFF by pressing the [HARMONY] button.

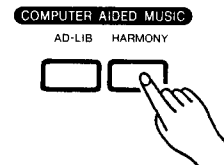

In the **HARMONY** mode, playing single notes on the keyboard produces automatic two- or four-part harmony, depending on the selected voice. The **HARMONY** mode is most useful with **SINGLE FINGER** or **FINGERED** Auto Accompaniment, described later.

When **HARMONY** is turned OFF, you can play single notes as well as your own chords or harmonies on the keyboard.

- If a **SPLIT** voice is selected, harmony will not be applied to the lower voice even if the **HARMONY** mode is ON.
- Only single notes can be played when the **HARMONY** mode is ON — with the exception of the lower voice when a **SPLIT** voice is selected.

Playing the PSR-100

Selecting Voices

The PSR-100 has 100 different voices (00 through 99, listed in the VOICE BANK printed on the top panel) that can be selected by using the number and [ENTER] buttons. To select any voice press two number buttons and then the [ENTER] button. To select voice number 04 (SOPRANO SAX), for example, press [0], [4], and then [ENTER]. The closed hi-hat voice will sound to confirm that the above buttons have been properly pressed.



The PSR-100 voices are divided into four categories:

- SINGLE** (voices 00—39): Single voices.
- ENSEMBLE** (40—49): Voices with an ensemble sound.
- DUAL** (50—79): Combinations of two voices.
- SPLIT** (80—99): Split voices with one voice playable on the left-hand section of the keyboard (to the left of the F#2 key) and the other playable on the right-hand section.

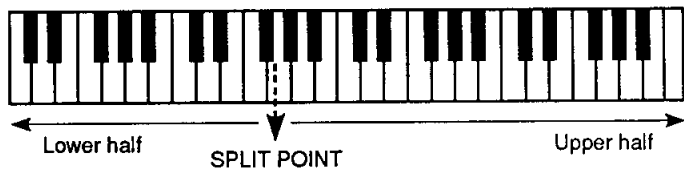

- SPLIT voices can only be used in the NORMAL mode. When the SINGLE FINGER or FINGERED Auto Accompaniment mode is selected only the upper voice will be used.

Adjusting the Volume

The PSR-100 volume can be adjusted in 11 steps. The volume is automatically set to “normal” when the POWER switch is turned ON.

Press the [VOLUME ▲] button to increase volume or the [VOLUME ▼] button to decrease volume. The volume is increased or decreased slightly each time the corresponding button is pressed. Press both the [VOLUME] buttons together to restore the normal volume setting.



- After switching on power the volume can be lowered up to 9 steps and raised by 1 step.

Playing a Rhythm Pattern

The PSR-100 has 22 different rhythm patterns that can be selected and played by pressing the appropriate white key on the keyboard while holding the [RHYTHM/SONG SELECT] button.

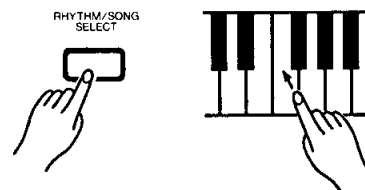

To play the SWING rhythm, for example, hold the [RHYTHM/SONG SELECT] button and press the white key on the keyboard labelled “SWING” above the keyboard. The SWING rhythm will begin playing immediately.

The rhythm pattern can be stopped at any time by pressing the [STOP] button.

- A different rhythm pattern can be selected in the same way even while a rhythm pattern is playing. In this case the new rhythm pattern begins playing from the beginning of the next measure.

Adjusting the Tempo (speed) of the Rhythm Pattern

The tempo of the selected rhythm pattern can be adjusted in 16 steps.

40, 50, 60, 73, 80, 92, 100, 112, 120, 132, 146, 159, 184, 200, 225, 240 (beats per minute)

A tempo of 120 beats per minute is automatically selected when the [POWER/MODE] switch is initially turned ON.

Press the [TEMPO ▲] button to increase the tempo or the [TEMPO ▼] button to decrease the tempo. The tempo is increased or decreased by one step each time the corresponding button is pressed. Press both the [TEMPO] buttons together to restore the normal “120” tempo setting.



Automatic Accompaniment

SINGLE FINGER Mode

SINGLE FINGER Auto Accompaniment makes it simple to produce beautifully orchestrated accompaniment using major, seventh, minor and minor-seventh chords by pressing a minimum number of keys in the SINGLE FINGER SECTION of the keyboard (to the left of the SINGLE FINGER SECTION marker). The bass and chord accompaniment produced is perfectly matched to the selected rhythm pattern.

1. Slide the [POWER/MODE] switch to the SINGLE FINGER position.

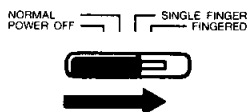

Select the desired rhythm in the normal way. The closed hi-hat voice will sound to confirm that the rhythm select key has been properly pressed. Although you can also select the melody (upper keyboard) voice you intend to use in the normal way, the PSR-100 automatically determines the voices to be used for the accompaniment bass and chords.

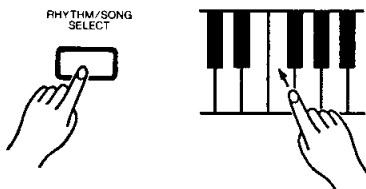

3. Press a Key in the SINGLE FINGER SECTION of the keyboard to start the accompaniment. If you press a "C" key, for example, a C-major accompaniment will be played. Press another key in the SINGLE FINGER SECTION to select a new chord. The key you press will always determine the "root" of the chord played (i.e. "C" for a C chord).

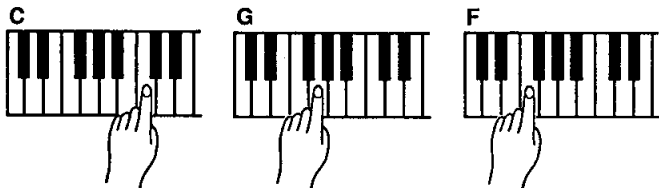

Playing Minor, Seventh, and Minor-seventh Chords

- For a minor chord, press the root key and a black key to its left.
- For a seventh chord, press the root key and a white key to its left.
- For a minor-seventh chord, press the root key and a white and black key to its left.



- The automatic accompaniment will continue playing even if you lift your fingers from the Auto Bass Chord keys. You only need to press the Auto Bass Chord keys when changing cords.

4. Press the [STOP] button to stop the accompaniment.

FINGERED Mode

The FINGERED mode is ideal if you already know how to play chords on a keyboard, since it allows you to supply your own chords for the Auto Bass Chord feature.

1. Slide the [POWER/MODE] switch to the FINGERED position.

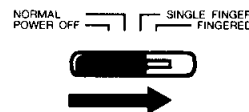

2. Select the desired rhythm in the normal way.
3. As soon as you play any chord in the FINGERED SECTION of the keyboard (to the left of the FINGERED SECTION marker), the PSR-100 will automatically begin to play the chord along with the selected rhythm and an appropriate bass line. The accompaniment will continue playing even if you release the Auto Bass Chord keys. When changing chords, be sure to release all keys before playing a new chord.
4. Press the [STOP] button to stop the accompaniment.

The PSR-100 will accept the following chord types:

- Major
 - Minor
 - Major seventh
 - Minor seventh
 - Seventh
 - Diminished
 - Augmented
- All other FINGERED mode operations are the same as in the SINGLE FINGER mode.

Automatic Ad-Lib Phrases

Press the [AD-LIB] button briefly while the AUTO ACCOMPANIMENT is running to produce a short "ad-lib" phrase that can be used as a "fill-in" for your performance. The [AD-LIB] button can be held to produce longer ad-lib lines.

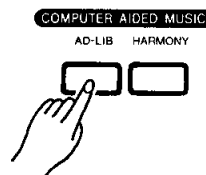

- If the [AD-LIB] button is pressed in the NORMAL mode, a C-major ad-lib phrase will be produced.

Song Accompaniment

The PSR-100 can play the accompaniment for 15 different songs that you can play along with, listed above the keyboard.

To select and start playback of a song accompaniment, hold the [RHYTHM/SONG SELECT] button and press the black key on the keyboard corresponding to the desired song.

The selected song will begin with a two-measure count-in.

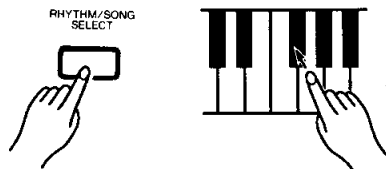

When a song accompaniment is first started, the melody for that song will also begin playing. If you want to mute the melody and leave only the accompaniment in order to play along, press the [DEMO (SONG ACCOMP. MELODY ON/OFF)] button. The [DEMO (SONG ACCOMP. MELODY ON/OFF)] button alternately turns the melody ON or OFF. When the melody is turned OFF, it is possible to select a different voice using the standard voice selection procedure.

DEMO
SONG ACCOMP.
MELODY ON/OFF



The song accompaniment can be stopped at any time by pressing the [STOP] button.

- Refer to the "Instruction Book".
* Published by Hal Leonard Publishing Corporation for Yamaha Corporation.
- The "Demo Tunes" of this keyboard are "Demonstration" purposes only. It is not possible to reproduce the "Demo Tunes" 100%.

Troubleshooting

Symptoms	Remedies
Reduced volume. Distortion.	Replace batteries.
Not all the notes are heard when you play a number of notes simultaneously.	The PSR-100 can produce a maximum of 8 notes at the same time (not including the rhythm sounds). Demo playback, automatic accompaniment and song accompaniment use up part of this quota.

Specifications

Keyboard:

49keys (C1-C5)

Voices:

100voices

SINGLE VOICE: TRUMPET, HORN, TROMBONE, TUBA, SOPRANO SAX, TENOR SAX, CLARINET, BASS CLARINET, OBOE, PICCOLO, FLUTE, PANFLUTE, RECORDER, OCARINA, PIANO, ELECTRIC PIANO, TOY PIANO, REED ORGAN, PIPE ORGAN, JAZZ ORGAN, HARPSICHORD, FUNKY CLAVI, ACCORDION, ACOUSTIC GUITAR, HAWAIIAN GUITAR, JAZZ GUITAR, ROCK GUITAR, ACOUSTIC BASS, ELECTRIC BASS, CELLO, BANJO, MANDOLIN, HARP, VIOLIN, CARILLON, TIMPANI, STEEL DRUM, GLOCKENSPIEL, MARIMBA, VIBRAPHONE

ENSEMBLE VOICE: BRASS 1, BRASS 2, CHIME, HONKY-TONK PIANO, WOODWIND 1, WOODWIND 2, 12STRING GUITAR, MARIMBA, STRINGS 1, STRINGS 2

DUAL VOICE: BRASS DUO, SAX & TOY PIANO, DROP, HARP & PANFLUTE, SAX DUO, STRING DUO, VIOLIN & CELLO, GLOCKEN & PIANO, SAX & CLARINET, TROMBONE & HORN, BANJO & FLUTE, GUITAR & TRUMPET, ORGAN & PICCOLO, JAZZ GUITAR & ORGAN, FUNKY SYNTH, CRYSTAL, RECORDER & BASS, CARILLON & OCARINA, ROCK GUITAR & BASS, STEEL DRUM & ORGAN, HARP & ACCORDION, BANJO & HORN, MANDOLIN & OBOE, SLAP BASS, PIANO & PANFLUTE, CARILLON & BANJO, STEEL DRUM & HARP, MARIMBA & RECORDER, SAX & BASS, BANJO & GUITAR

SPLIT VOICE: BASS/SAX, BASS/PIANO, GUITAR/E.PIANO, PIANO/TRUMPET, HARPSICHORD/FLUTE, GLOCKEN/MARIMBA, BASS/CLARINET, BASS/ROCK GUITAR, ACCORDION/PANFLUTE, E.PIANO/SAX, PIANO/VIOLIN, TOY PIANO/OCARINA, BASS/BANJO, GUITAR/SAX, BASS/CLAVI, ACCORDION/PICCOLO, PIANO/HARP, ORGAN/JAZZ GUITAR, CELLO/FLUTE, BASS/PIANO/PERCUSSION

Rhythm styles:

POP ROCK, BOOGIE WOOGIE, RHUMBA, 8BEAT, 16BEAT, ROCK'N'ROLL, HARD ROCK, ROCK-A-BALLAD, DISCO, BOSSA NOVA, SWING, FUNK, TECHNO ROCK, SHUFFLE, SAMBA, JAZZ WALTZ, REGGAE, COUNTRY, TANGO, WALTZ, MARCH 1, MARCH 2

Song Accompaniment:

JOY TO THE WORLD, BROTHER JOHN, THE OLD FOLKS AT HOME, HOUSE OF RISING SUN, A LITTLE BROWN JUG, SILENT NIGHT, JINGLE BELLS, AVE MARIA, DIE LORELEI, CAMPTOWN RACES, WHEN THE SAINTS GO MARCHING IN, BRAHMS' LULLABY, YESTERDAY, HEY JUDE, VENUS

Other Controls:

VOLUME, TEMPO, RHYTHM/SONG SELECT, STOP, AD-LIB, HARMONY, DEMO (SONG ACCOMP. MELODY ON/OFF), VOICE SELECT 1-0, ENTER, POWER/MODE (OFF, NORMAL, SINGLE FINGER, FINGERED)

Auxiliary Jacks:

HEADPHONES/AUX. OUT, DC 9-12V IN

Main Amplifiers:

2.0W x 2

Speakers:

10cm (3-15/16") 4Ω x 2

Rated Voltage:

DC 9V (Six SUM-1, "D" size, R-20 or equivalent batteries), AC Power Adaptor (PA-1, PA-1B or PA-3)

Dimensions (W x D x H):

930mm x 279.6mm x 109.4mm
(36-5/8" x 11" x 4-5/16")

Weight:

3.3kg (7.2lbs.) excluding batteries

Supplied Accessory:

Music Stand

* Specifications subject to change without notice

FCC INFORMATION (U.S.A.)

1. IMPORTANT NOTICE: DO NOT MODIFY THIS UNIT!

This product, when installed as indicated in the instructions contained in this manual, meets FCC requirements. Modifications not expressly approved by Yamaha may void your authority, granted by the FCC, to use the product.

2. IMPORTANT:

When connecting this product to accessories and/or another product use only high quality shielded cables. Cable/s supplied with this product MUST be used. Follow all installation instructions. Failure to follow instructions could void your FCC authorization to use this product in the USA.

3. NOTE:

This product has been tested and found to comply with the requirements listed in FCC Regulations, Part 15 for Class "B" digital devices. Compliance with these requirements provides a reasonable level of assurance that your use of this product in a residential environment will not result in harmful interference with other electronic devices. This equipment generates/uses radio frequencies and, if not installed and used according to the instructions found in the users manual, may cause interference harmful to the operation of other electronic devices. Compliance with FCC regulations does not guarantee that interference will not occur in all installations. If this product is found to be the source of interference, which can be determined by turning the unit "OFF" and "ON", please try to eliminate the problem by using one of the following measures:

Relocate either this product or the device that is being affected by the interference.

Utilize power outlets that are on different branch (circuit breaker or fuse) circuits or install AC line filter/s.

In the case of radio or TV interference, relocate/reorient the antenna. If the antenna lead-in is 300 ohm ribbon lead, change the lead-in to co-axial type cable.

If these corrective measures do not produce satisfactory results, please contact the local retailer authorized to distribute this type of product. If you can not locate the appropriate retailer, please contact Yamaha Corporation of America, Electronic Service Division, 6600 Orangethorpe Ave, Buena Park, CA90620

The above statements apply ONLY to those products distributed by Yamaha Corporation of America or its subsidiaries.

WARNING: CHEMICAL CONTENT NOTICE!

The solder used in the manufacture of this product contains LEAD. In addition, the electrical/electronic and/or plastic (where applicable) components may also contain traces of chemicals found by the California Health and Welfare Agency (and possibly other entities) to cause cancer and/or birth defects or other reproductive harm.

DO NOT REMOVE ANY ENCLOSURE COMPONENTS! There are no user serviceable parts inside. All service should be performed by a service representative authorized by Yamaha to perform such service.

IMPORTANT MESSAGE: Yamaha strives to produce products that are both user safe and environmentally "friendly". We sincerely believe that our products meet these goals. However, in keeping with both the spirit and the letter of various statutes we have included the messages shown above and others in various locations in this manual.

- This applies only to products distributed by Yamaha Corporation of America.
- Dies bezieht sich nur auf die von der Yamaha Corporation of America vertriebenen Produkte.
- Ceci ne s'applique qu'aux produits distribués par Yamaha Corporation of America.
- Esto se aplica solamente a productos distribuidos por Yamaha Corporation of America.

YAMAHA

The serial number of this product may be found on the bottom of the unit. You should note this serial number in the space provided below and retain this manual as a permanent record of your purchase to aid identification in the event of theft.

Model No. PSR-100

Serial No.

Concerning Warranty

This product was made for international distribution, and since the warranty for this type of product varies from marketing area to marketing area, please contact the selling agency for information concerning the applicable warranty and/or service policies.

Le numéro de série de ce produit figure sur le socle. Il conviendra de noter ce numéro de série dans l'espace réservé ci-dessous et de conserver ce manuel: celui-ci constitue le document permanent de votre achat et permet l'identification en cas de vol.

Modèle No. PSR-100

No. de série

Remarque relative à la garantie

Ce modèle est destiné à être distribué à l'échelle internationale. Etant donné que les conditions de garantie pour ce type de produit varient en fonction des zones de commercialisation, prière de prendre contact avec l'agence chargée des ventes pour tous renseignements relatifs aux conditions de garantie et de service après-vente.

Die Seriennummer befindet sich an der Unterseite des Instrumentes. Wir empfehlen, diese Nummer sicherheitshalber an der unten vorgesehenen Stelle einzutragen, um sie auch im Falle eines Diebstahls jederzeit zur Hand zu haben.

Modell-Nr. PSR-100

Serien-Nr.

Hinweis zur Garantie

Dieses Produkt wird international vertrieben, und die Garantiebedingungen sind von Vertriebsland zu Vertriebsland verschieden. Ihr Händler gibt Ihnen gerne genauere Informationen zu den in Ihrem Land gültigen Garantie- und/oder Servicebedingungen.

El número de serie de este producto se encuentra en la parte inferior de la unidad. Sírvase anotar este número de serie en el espacio proporcionado abajo y guarde este manual como comprobante de compra para ayudar a la identificación en caso de robo.

Nº de modelo PSR-100

Nº de serie

Concerniente a la garantía

Este producto ha sido fabricado para ser distribuido internacionalmente y, como la garantía para este tipo de producto varía en relación a su área de comercialización, sírvase consultar con el agente de ventas sobre la información en torno a la garantía aplicable y/o políticas de servicio.