

MRX Setup Manual

This manual serves as an introduction to possible installation methods and application examples for the MRX series of DSP processors used in conjunction with MTX-MRX Editor control software.

Please refer to the owner's manual on a device about the details of MRX, and refer to the "MTX-MRX Editor User Guide" (PDF file) about the details of MTX-MRX Editor.

Information

- The software and this manual are the exclusive copyrights of Yamaha Corporation.
- Copying of the software or reproduction of this manual in whole or in part by any means is expressly forbidden without the written consent of the manufacturer.
- Yamaha makes no representations or warranties with regard to the use of the software and documentation and cannot be held responsible for the results of the use of this manual and the software.
- Future upgrades of application and system software and any changes in specifications and functions will be announced at the following website.
<http://www.yamahaproaudio.com/>
- The screen displays as illustrated in this manual are for instructional purposes, and may appear somewhat different from the screens which appear on your computer.
- Copying of the commercially available musical data including but not limited to MIDI data and/or audio data is strictly prohibited except for your personal use.
- Ethernet is trademarks of Xerox Corporation.
- Windows is a registered trademark of Microsoft® Corporation in the United States and other countries.
- iPad, Bonjour, AirDrop and iTunes are trademarks of Apple Inc., registered in the U.S. and other countries.
- The SDHC and SD logos are trademarks of SD-3C, LLC.



- The company names and product names in this manual are the trademarks or registered trademarks of their respective companies.

Introduction

The MRX Setup Manual explains how to create setups using the MRX and MTX-MRX Editor. As examples, we will provide simple explanations of the typical setups described below. For detailed parameter settings, refer to “MTX-MRX Editor User Guide” and “MRX Designer User Guide”.

When you install MTX-MRX Editor, the three example files described here will be found in the following folders.

- **32-bit operating system**

C:\Program Files\Yamaha\MTX-MRX Editor\V*.*\ProjectFile

- **64-bit operating system**

C:\Program Files(x86)\Yamaha\MTX-MRX Editor\V*.*\ProjectFile

. will be the version of the installed MTX-MRX Editor.

Example 1 : MRX7-D Ballroom-*.mtx

Example 2 : MRX7-D Conference-*.mtx

Example 3 : MRX7-D+PGM1+MCP1 Fitness-*.mtx

-* is a management number. In some cases, there will be no -*.

Example 1) Ballroom where the Room Combiner can be used

This is an example where the sections of the room can be split or combined, as in a ballroom.

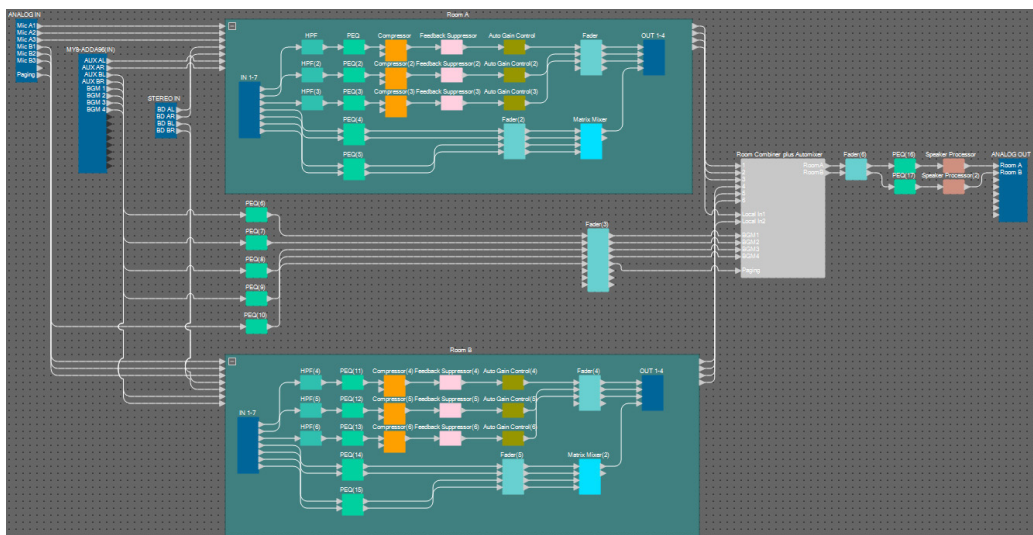
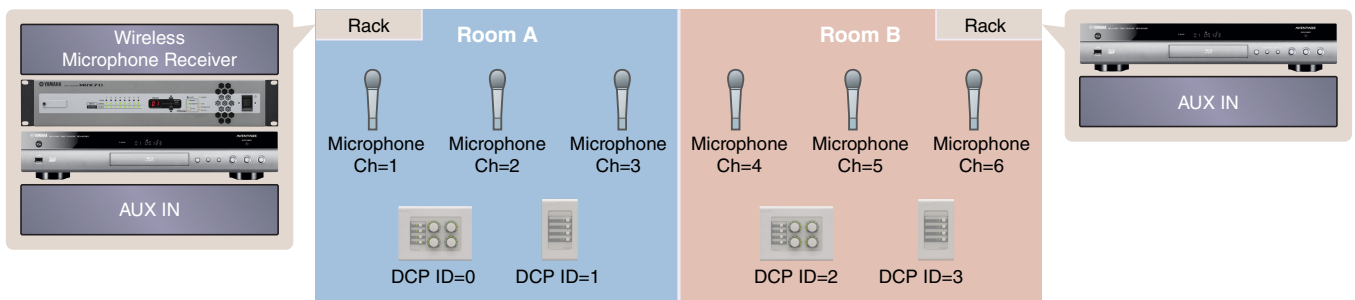

This example assumes that you're using the following equipment.

- MRX7-D × 1
- MY8-ADDA96 × 1
- DCP4V4S × 2
- DCP4S × 2
- Amplifier (two channels of amplification)
- Speakers (the number needed)
- SD memory card × 1
- Background music source such as a Blu-ray player × 2
- Stereo input ports such as an AUX IN × 2
- Wireless microphone receivers (6 channels)
- Wireless microphones × 6

The number of speakers is not specified; choose amplifiers that are suitable for your speaker setup. You will also need to provide the appropriate number of cables.

Example 2) Remote conferencing system that also uses Speech Privacy

This is an example where Speech Privacy is used to prevent the discussion content from being leaked outside of the remote conferencing system room and other external rooms. We'll assume that there is a single remote location, and that there are eight mics in the conference room.

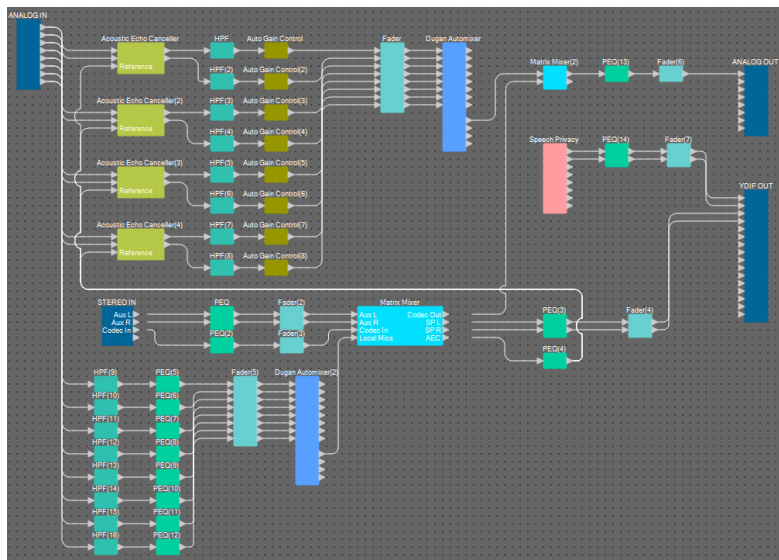
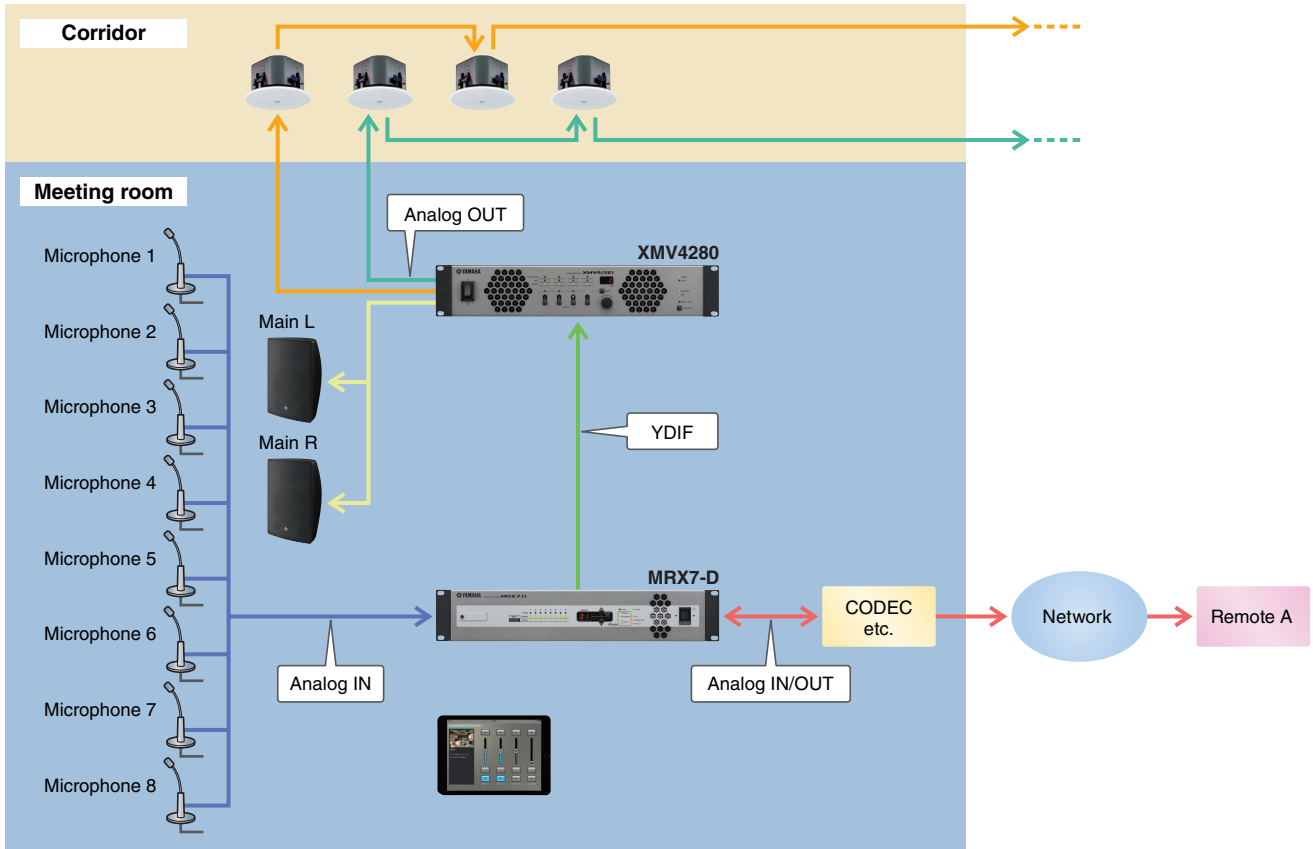

This example assumes that you're using the following equipment.

- MRX7-D × 1
- XMV4280 × 1
- iPad with ProVisionaire Touch installed × 1
- CODEC × 1
- Speakers (the number needed)
- SD memory card × 1
- Stereo input ports such as an AUX IN × 2
- Microphones × 8

The number of speakers is not specified. You will also need to provide the appropriate number of cables.

Example 3) A paging system using the PGM1

This example envisions a paging system using the PGM1 installed in a space such as a fitness club, and using the MCP1 to switch the background music.

Powered speakers such as the DBR15 are placed in spaces that require high volume.

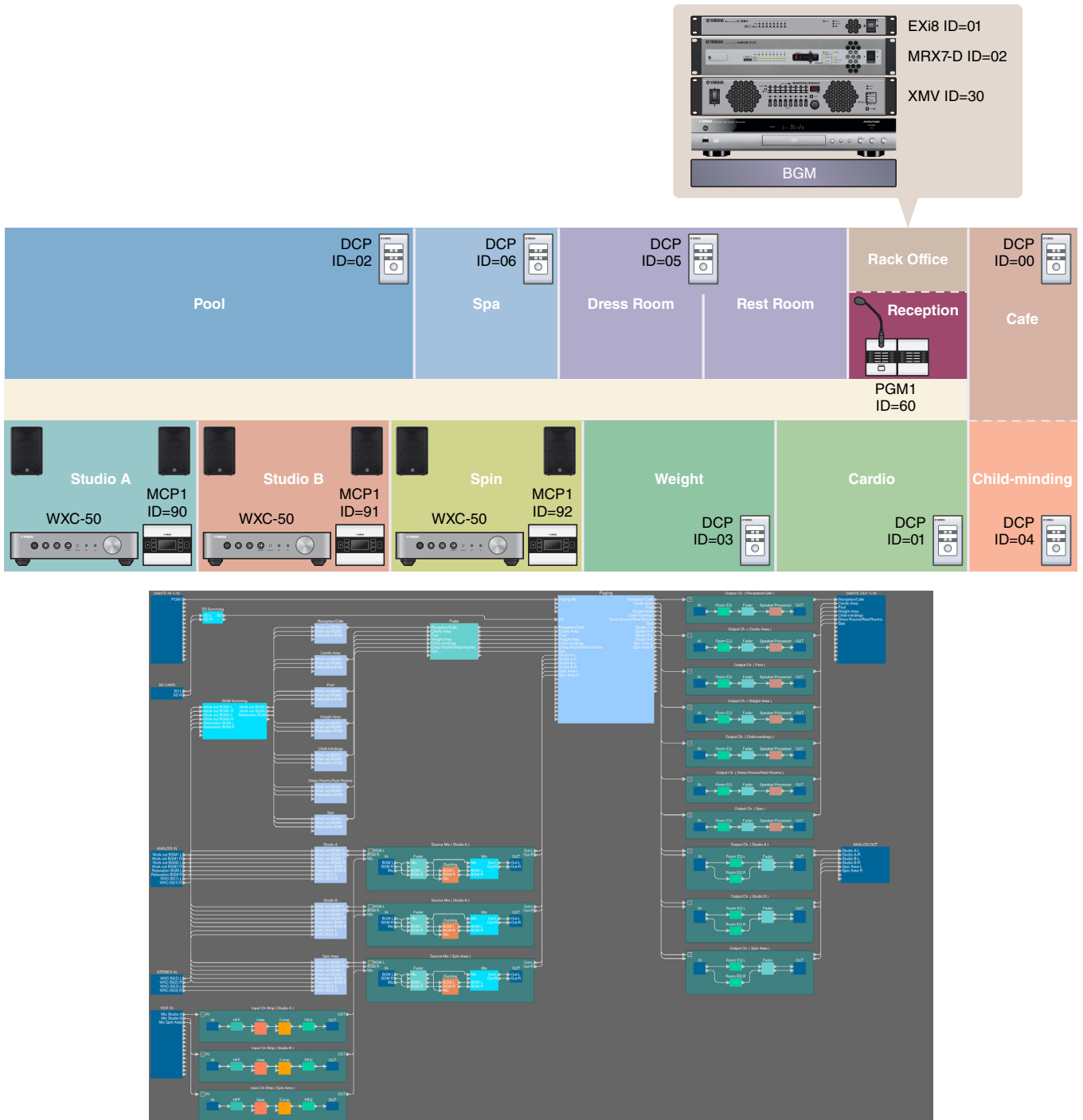

This example assumes that you're using the following equipment.

- MRX7-D × 1
- EXi8 × 1
- XMV8280-D × 1
- DCP1V4S × 7
- MCP1 × 3
- PGM1 × 1
- PGX1 × 1
- PoE-compatible gigabit network switch such as the SWR2100P-5G × 1
- WXC-50 × 3
- Powered speakers such as the DBR15 × 6
- XLR (male) output jacks × 6 (for powered speakers)
- Speakers (the required number)
- SD memory card × 1
- Background music sources such as a Blu-ray player × 3
- Wireless mic receivers (for three channels)
- Headset mics for wireless use × 3

The number of speakers is not specified; choose amplifiers that are suitable for your speaker setup. You will also need to provide the appropriate number of cables.

Setup workflow

The following table shows the workflow for connecting equipment such as MTX series signal processors and XMV series power amplifiers to your computer, and making settings in MTX-MRX Editor.

		Example 1	Example 2	Example 3
Installing MTX-MRX Editor		Page 5		
Starting up MTX-MRX Editor		Page 6		
Using the Device Configuration Wizard to create your device setup		Page 7	Page 65	Page 110
Configuring the settings on the MRX	Placing and connecting the components	Page 13	Page 71	Page 117
	Compiling	Page 32	Page 88	Page 161
	Specifying snapshots	Page 33	—	—
	Setting a parameter link group	Page 38	Page 89	Page 162
	Making the DCP settings	Page 42	—	Page 166
	Making MCP1 settings	—	—	Page 176
	Creating the Remote Control Setup List used by ProVisionaire Touch	—	Page 93	—
	Storing presets	Page 53	Page 97	Page 185
Making EXT. I/O settings		—	Page 99	Page 190
Connecting the equipment		Page 61	Page 104	Page 198
Powering-on the MRX		Page 62	Page 105	—
Powering-on the amp		Page 62	Page 105	—
Specifying the computer's TCP/IP address		Page 62	Page 105	Page 199
Sending the Speech Privacy environmental sound		—	Page 106	—
Taking MTX-MRX Editor online		Page 63	Page 107	Page 200
Verifying that the settings were applied		Page 64	Page 108	Page 201

For details on PGM1 settings, refer to [page 142](#).

Installing MTX-MRX Editor

In order to connect MRX series devices to your computer, you'll need to download MTX-MRX Editor from the “download” page of the Yamaha Pro Audio website.

<http://www.yamahaproaudio.com/>

System Requirements

OS	Windows 10 (32bit/64bit)
CPU	Core i3/i5 or better
Memory	4 GB or more
H.D.D.	230 MB or more free (When you install, need 480 MB or more free.)
Other	Bonjour must be installed, Ethernet (1000BASE-T or higher)

NOTE

The System Requirements described above are applied to the MTX-MRX Editor version 4.0.0. You can check the latest version information of each program and its system requirements at the following website

<http://www.yamahaproaudio.com/>

The system requirements may differ slightly depending on the particular computer.

Follow the steps below to install MTX-MRX Editor.

- 1. After decompressing the downloaded file, double-click “setup.exe” in the decompressed file location.**

The MTX-MRX Editor setup wizard will appear.

- 2. Proceed with the installation as directed by the instructions in the screen.**

NOTE

If the computer you're using does not have Bonjour installed, a screen asking you to install Bonjour will appear during the installation.

If you are asked to install Bonjour, download Bonjour from the Yamaha Pro Audio website, and install it. Then install MTX-MRX Editor again.

<http://www.yamahaproaudio.com/>

Starting up MTX-MRX Editor

Follow the steps below to start up MTX-MRX Editor.

- 1. Double-click the MTX-MRX Editor icon on the desktop.**

NOTE

The “User Account Control” dialog box may appear. Click [Continue] or [Yes].

- 2. If the “Network Setup” dialog box appears, click [OK] or [Cancel].**

You'll be performing the setup during the step “Specifying the computer's TCP/IP address”

- 3. The “Startup” dialog box will appear; click [New file] and then click [OK].**

The “Device Configuration Wizard” will start up. Now you can proceed to make basic settings.

We will use specific examples to explain “Using the Device Configuration Wizard to create your device setup” and subsequent steps.

Example 1) Ballroom where the Room Combiner can be used

Using the Device Configuration Wizard to create your device setup

Before setting the internal configuration on the MRX, use the wizard on the MTX-MRX Editor to create a configuration for the device.

After you've made basic settings, you'll be able to print information about system cabling and ID numbers. Use the following procedure to make basic settings.

1. Type a name for the MTX/MRX System you'll be constructing, and click [Next>].

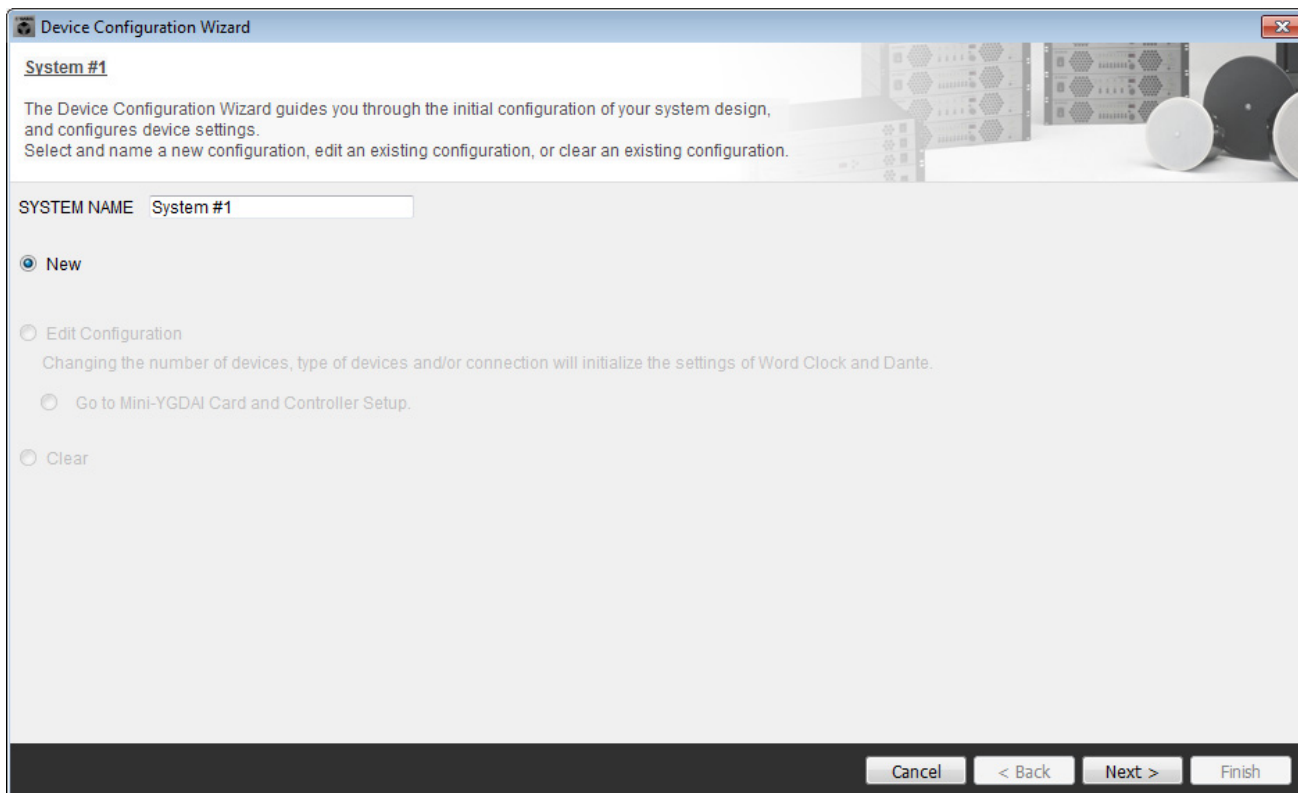

The screenshot shows the 'Device Configuration Wizard' window. The title bar reads 'Device Configuration Wizard'. Below the title bar, the text 'System #1' is displayed. A descriptive paragraph states: 'The Device Configuration Wizard guides you through the initial configuration of your system design, and configures device settings. Select and name a new configuration, edit an existing configuration, or clear an existing configuration.' Below this text, there is a text input field labeled 'SYSTEM NAME' containing the text 'System #1'. Underneath the input field, there are four radio button options: 'New' (which is selected), 'Edit Configuration' (with a sub-note: 'Changing the number of devices, type of devices and/or connection will initialize the settings of Word Clock and Dante.'), 'Go to Mini-YGDAI Card and Controller Setup.', and 'Clear'. At the bottom right of the window, there are four buttons: 'Cancel', '< Back', 'Next >', and 'Finish'.

2. Specify the number of units that will be connected in your MTX/MRX System, and click [Next>].

In “YDIF Connected,” specify 1 as the number of MRX7-D units.

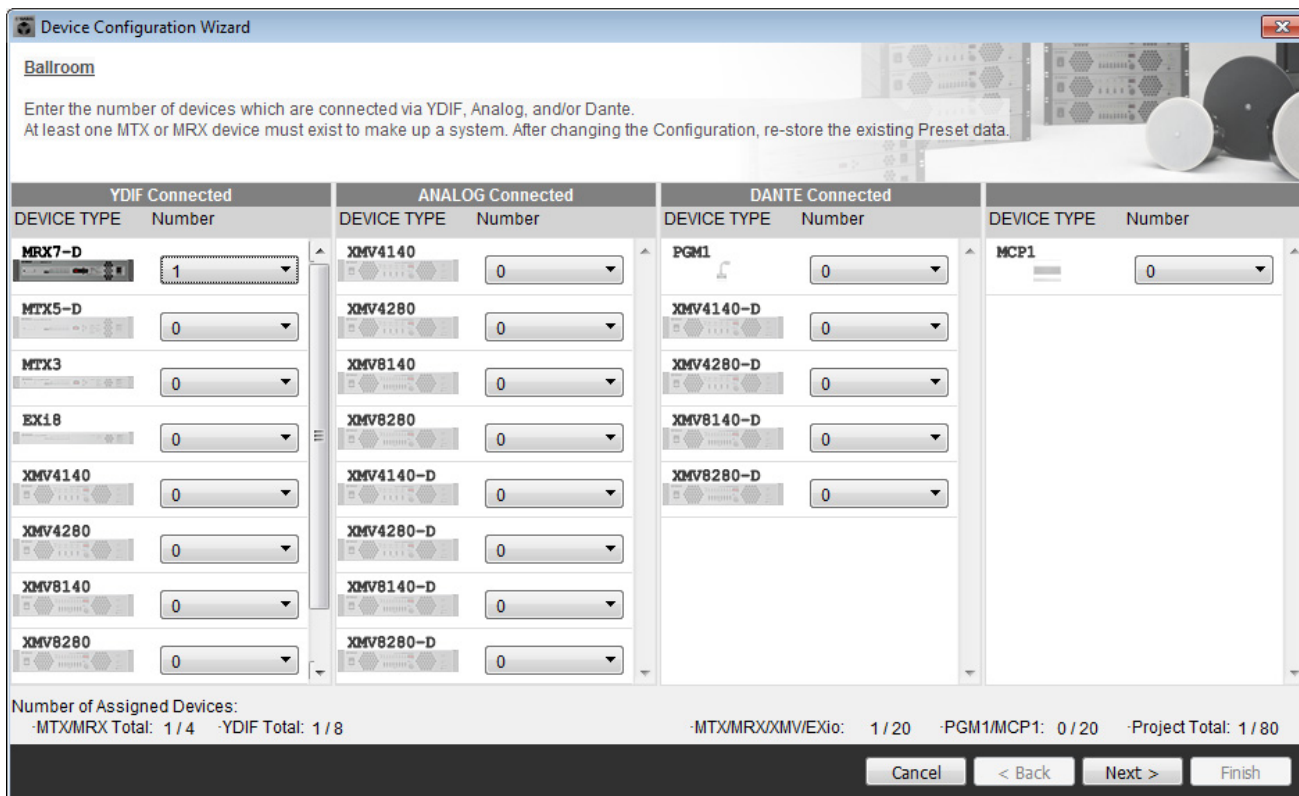

3. Verify that the MRX’s UNIT ID is 1, and then click [Next>].

Unless you have specific reasons for doing so, use the UNIT ID that is assigned.

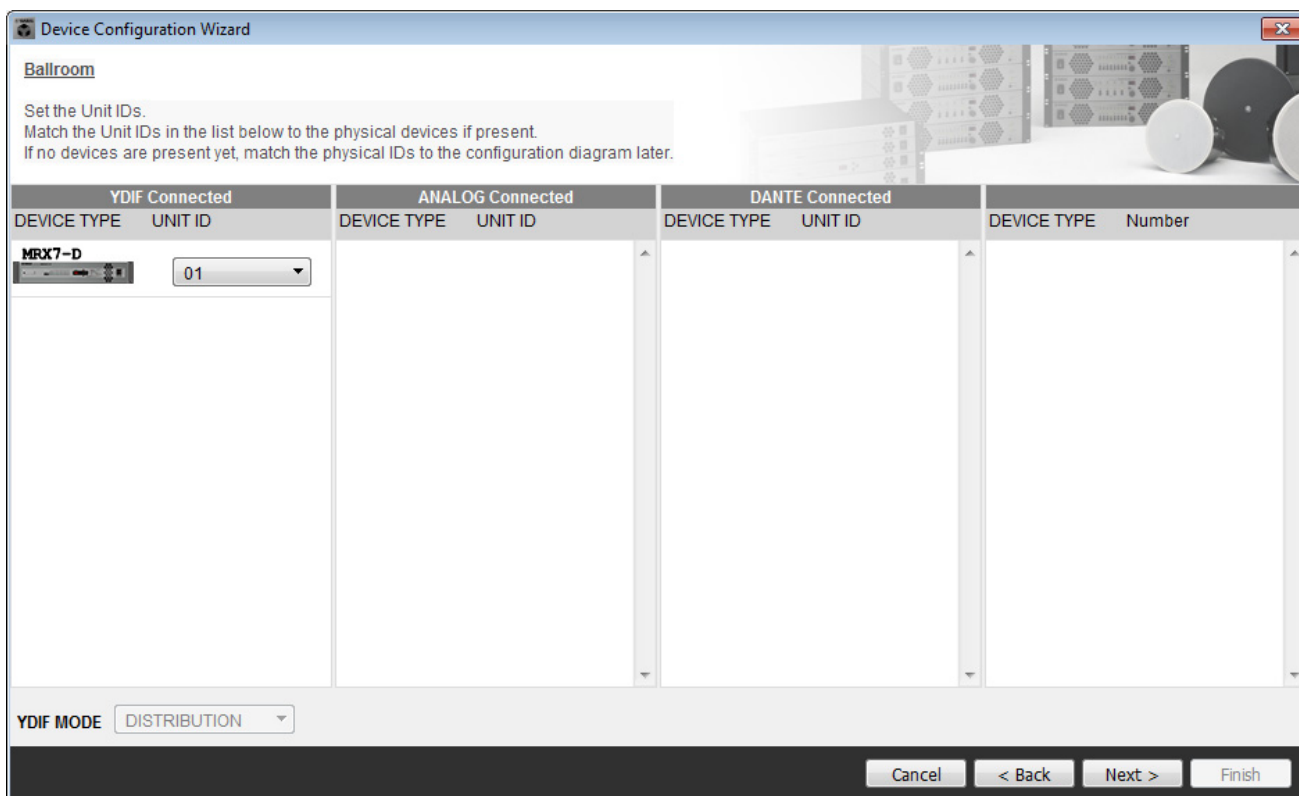

4. Set the MRX's [UNIT ID] rotary switch and DIP switch.

You will set the computer's IP address after completing the wizard, in "Specifying the computer's TCP/IP address." If the MRX is not nearby, make settings during the step "Connecting the equipment."

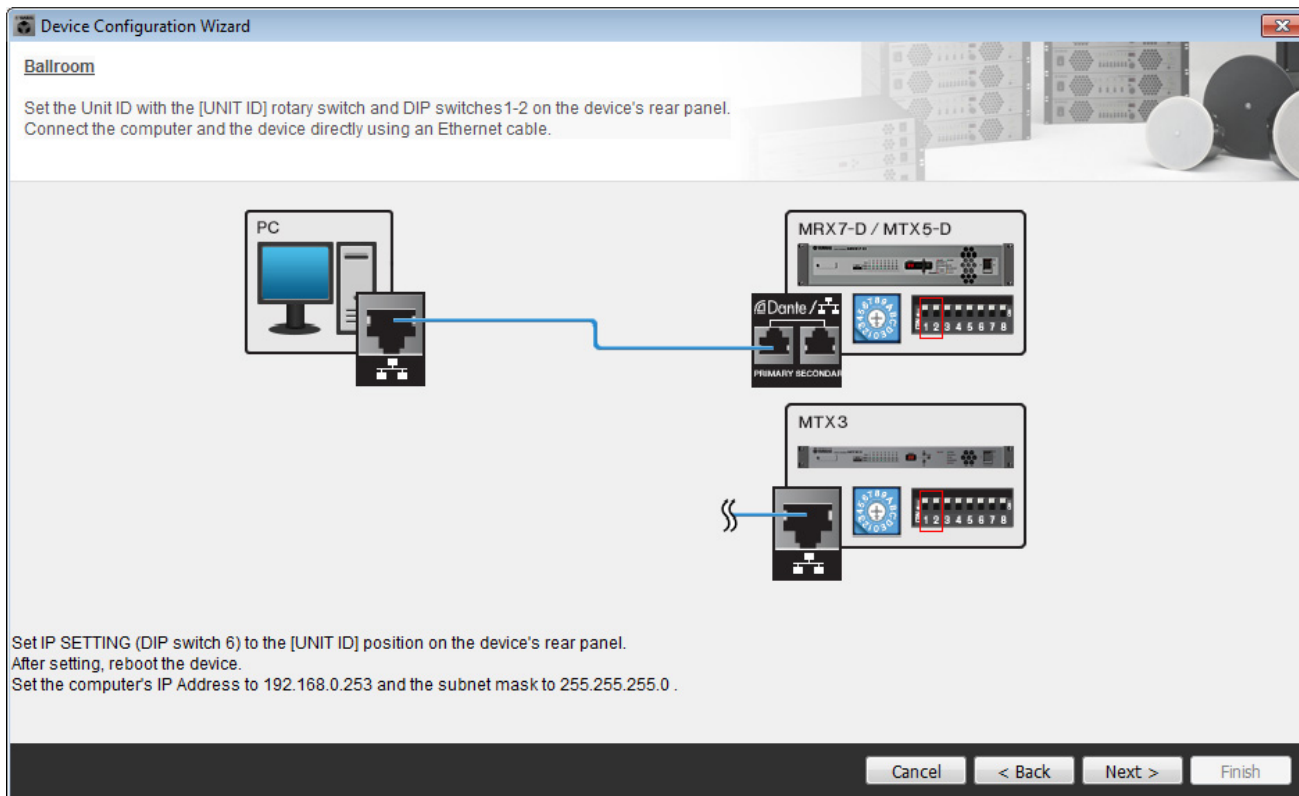

Make the following settings.

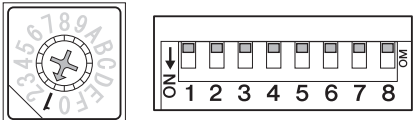
<p>MRX7-D</p> 	<p>UNIT ID = 01 [UNIT ID] rotary switch = 1 DIP switches are all OFF (upward)</p>
--	---

5. When you've finished setting the MRX's [UNIT ID] rotary switch and DIP switch, click [Next>].

6. Verify that the MRX is shown, and click [Next>].

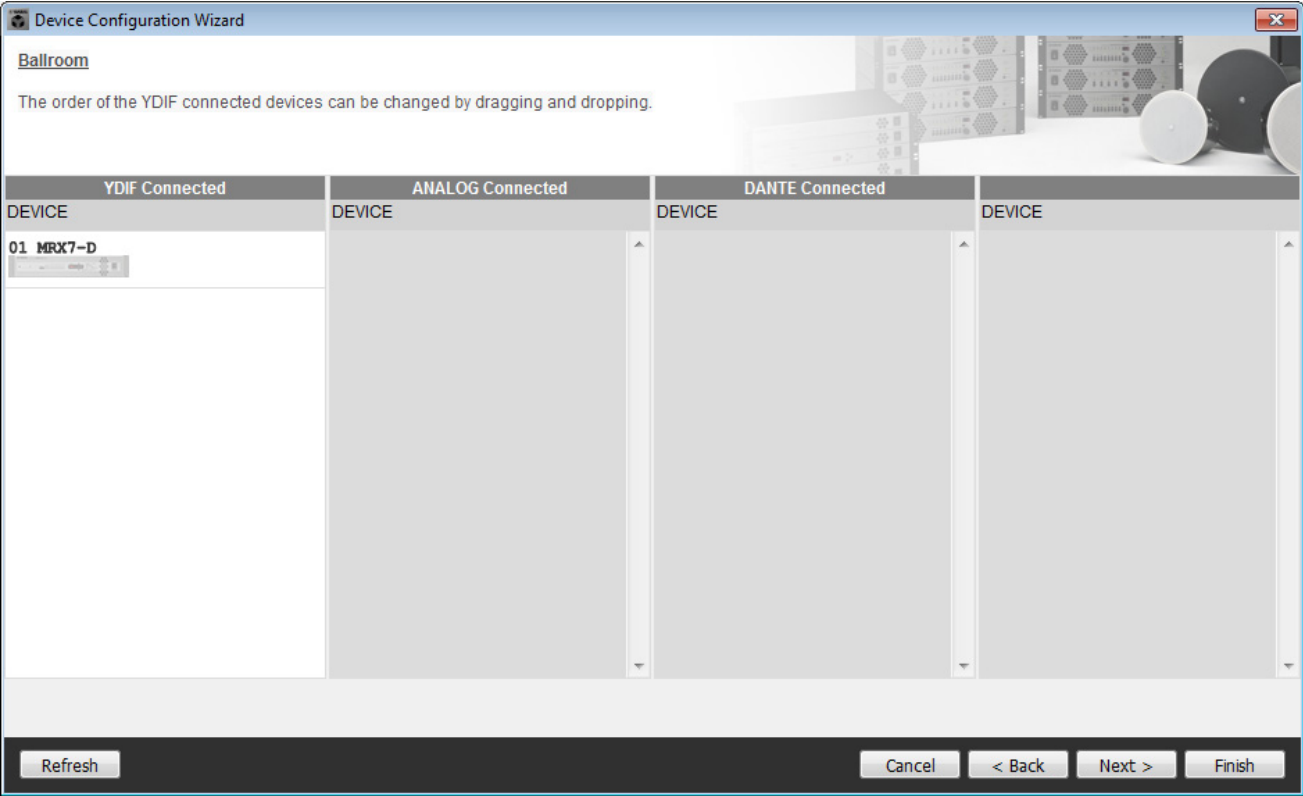

7. Click [Next>].

On the MRX Designer of the MRX, select the Mini-YGDAI card.

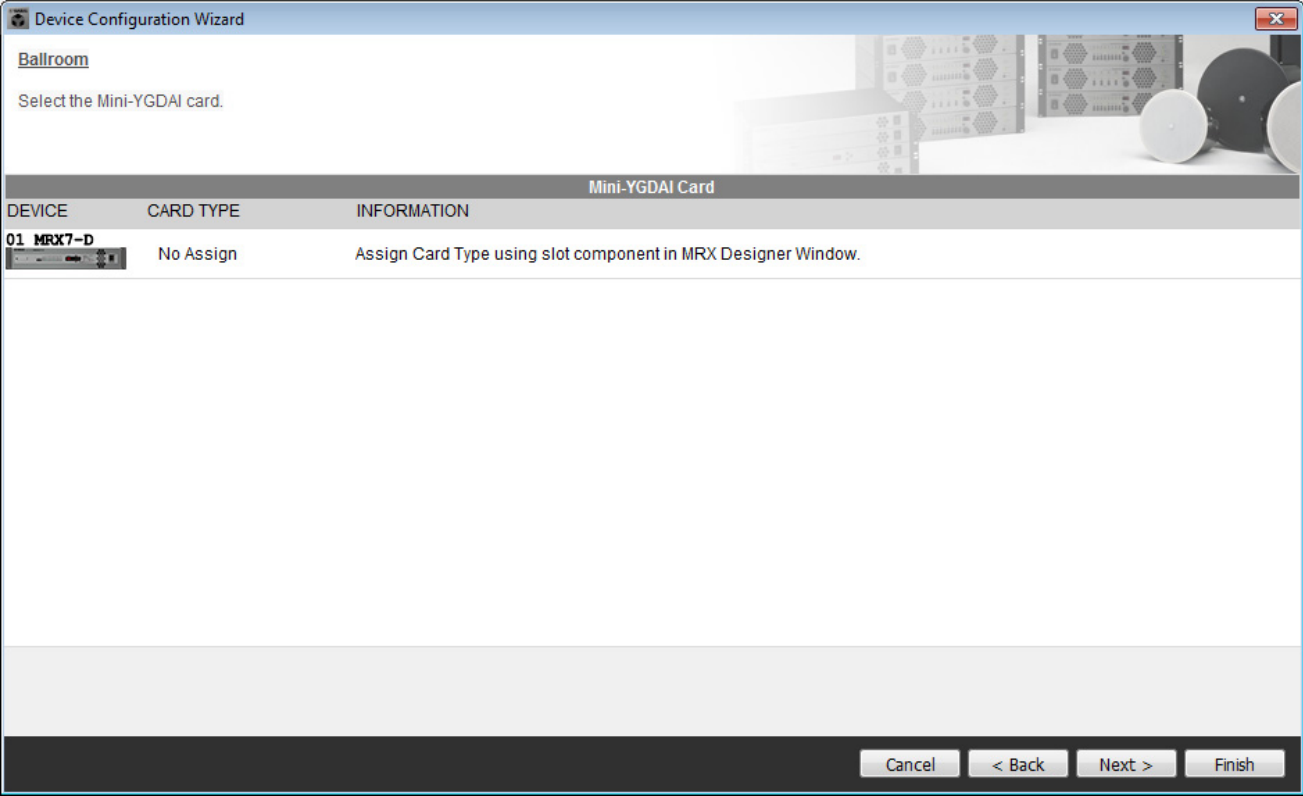

8. Choose the model of DCP that is connected to the MRX, enter a device name, and click [Finish].

One DCP4S and one DCP4V4S will be placed respectively in each room, allocated as follows: ID=0 is DCP4V4S in Room A, ID=1 is DCP4S in Room A, ID=2 is DCP4V4S in Room B, ID=3 is DCP4S in Room B.

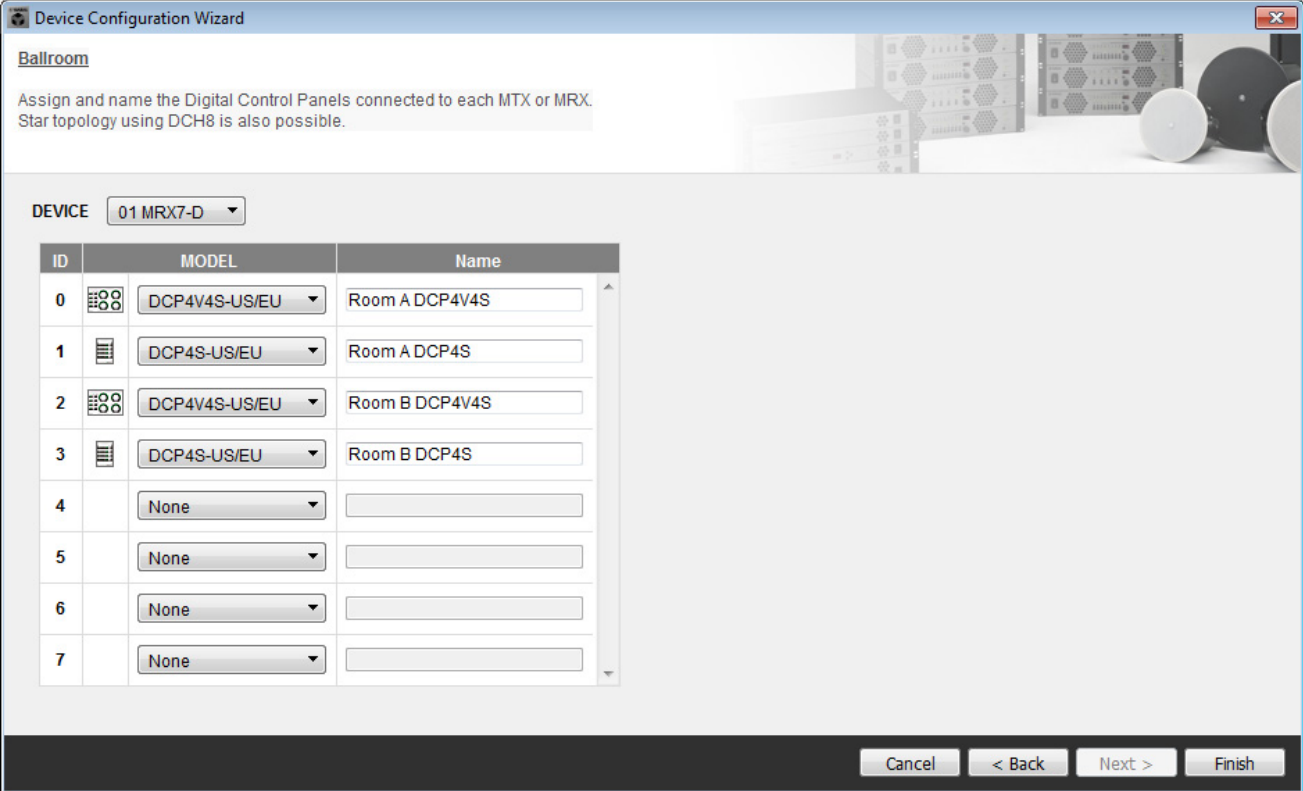

- When you see the dialog box “Display the configuration diagram? The diagram can also be printed.” click [Yes].

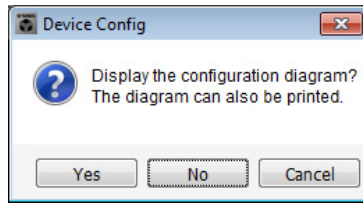

A cabling diagram will appear. If you want, click [Print] to print the diagram. To close the screen, click [Close].

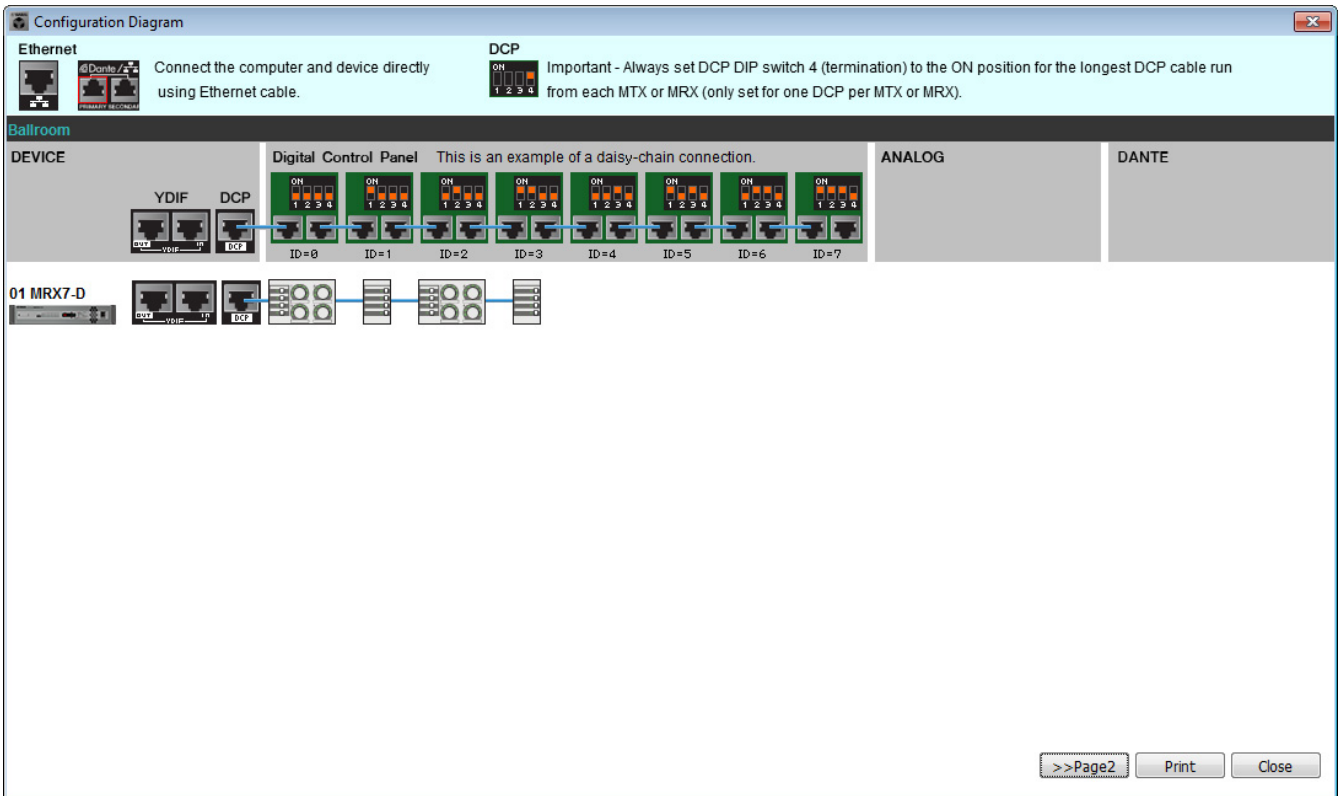

Set the DIP switches of the DCP units as shown in the “Digital Control Panel” section of the schematic diagram. For the last DCP (ID=3), set DIP switch 4 ON (upward).

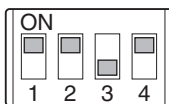

NOTE

If you want to view the cabling diagram again, do so by choosing [File] menu → [Print Configuration Diagram].

If you want to use the Device Configuration Wizard to change the device configuration, click the [Device Config] button in the Project screen.

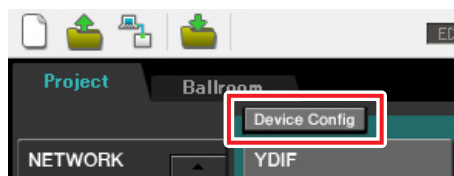

Configuring the settings on the MRX

Placing and connecting the components

Use the MRX Designer to set an internal configuration on the MRX.

When you have finished each setting, we recommend that you save the configuration from the [File] menu → [Save].

NOTE

The “User Account Control” dialog box may display. Click either [Continue] or [Yes].

Starting the MRX Designer

Click the tab for the system name that you set in step 1 of “Using the Device Configuration Wizard to create your device setup” to go to the settings screen.

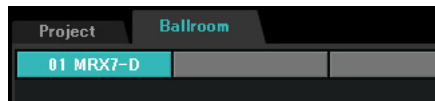

After going to the settings screen, click the “Open MRX Designer” button to start the MRX Designer.



Placing and connecting the components related to the mics in Room A

Here we will place and connect the components related to the mics in Room A.

1. Place the components shown below by dragging them from the “Components” area and dropping them into the Design sheet.

- “ANALOG IN”
- “HPF” (MONO)
- “PEQ” (MONO, 4 BAND)
- “Compressor” (MONO)
- “Notch FBS”(Feedback Suppressor)
- “Auto Gain Control” (MONO)
- “Fader” (4 CH)

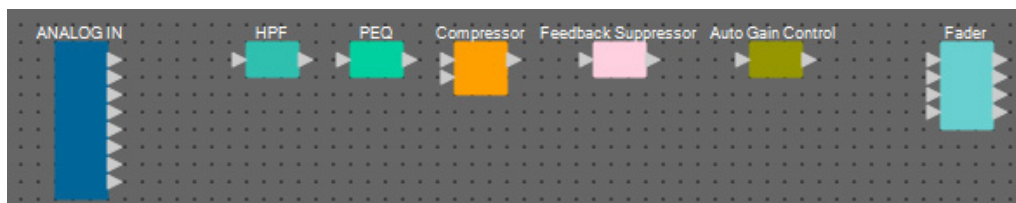

2. Connect the space between the ports from “HPF” to “Auto Gain Control” by dragging and dropping.

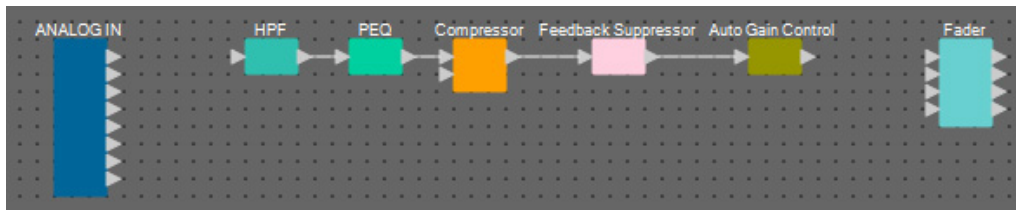

3. Select the area between “HPF” and “Auto Gain Control”, so that the components and wires are selected.

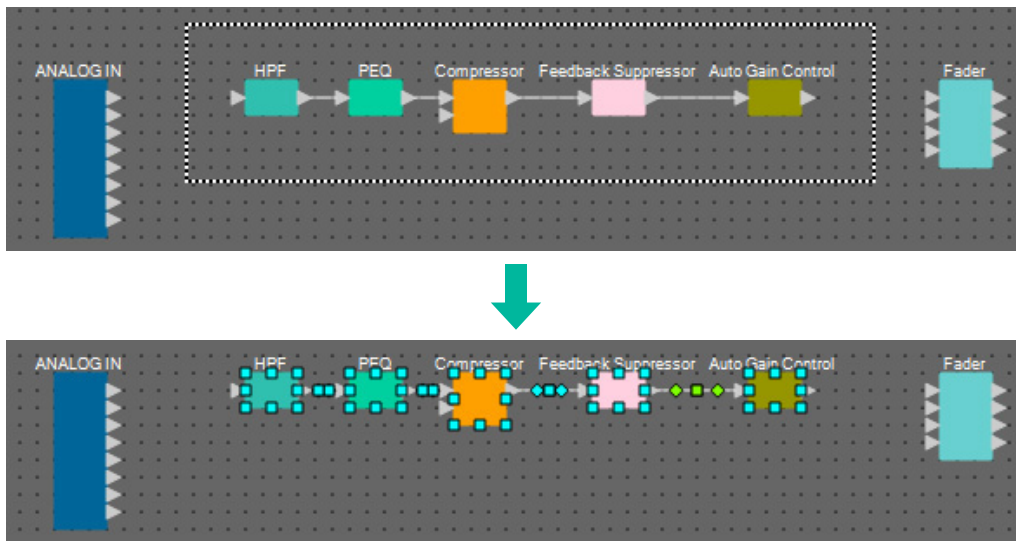

4. Copy the selected components and wires and paste twice, or drag and drop the selected components and wires while holding down <Ctrl>.

Change the placement of the components as need be.

Here’s how to copy:

- <Ctrl> + <C>
- Right-click and select [Copy] from the context menu
- Select [Copy] from the [Edit] menu

Here’s how to paste:

- <Ctrl> + <V>
- Right-click and select [Paste] from the context menu
- Select [Paste] from the [Edit] menu

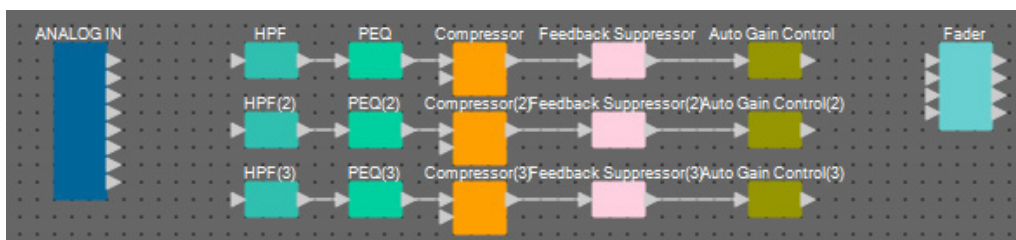

5. Connect each Auto Gain Control to the Faders.

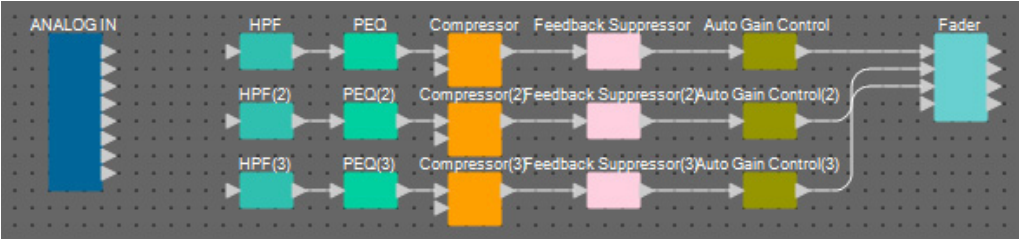

6. Double-click “Fader.”

The “Fader” component editor will appear.

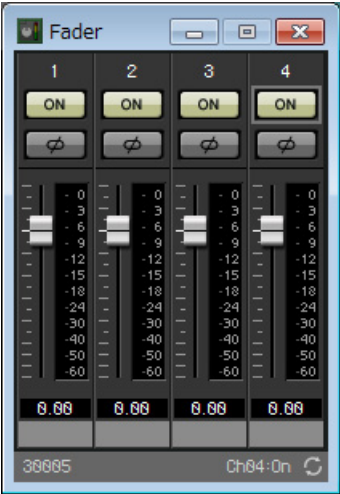

7. Turn channel 4 (which has not been connected) off, and click the [x] button at the top right-hand corner to close the component editor.



■ **Placing and connecting the components not related to the mics in Room A**

Place and connect the components related to the Blu-Ray player and input from AUX IN in Room A.

1. Place the components shown below by dragging them from the “Components” area and dropping them into the Design sheet.

- “STEREO IN”
- “SLOT” (MY8-ADDA96)
- “PEQ” (STEREO, 4 BAND) × 2
- “Fader” (4 CH)
- “Matrix Mixer” (IN=4, OUT=2)

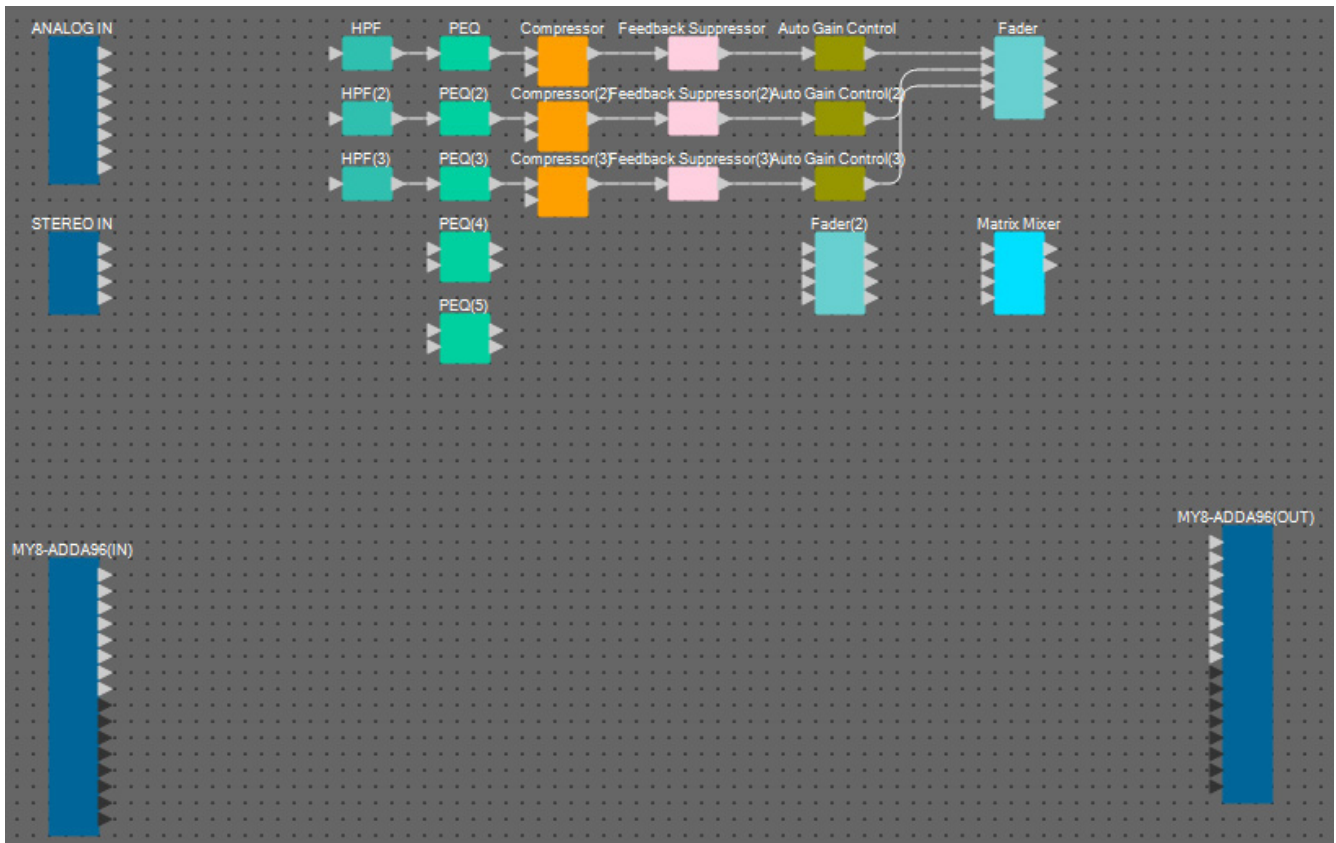

2. Connect the space between the ports from “PEQ” to “Matrix Mixer” by dragging and dropping.

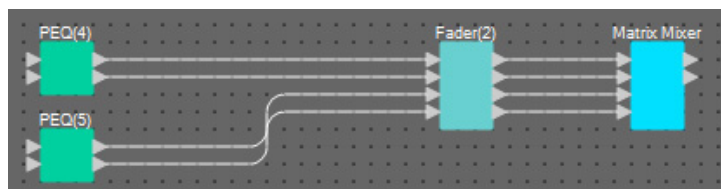

3. Double-click “Fader(2).”

The “Fader” component editor will appear.



4. Turn channels 3 and 4 off.

Register whether the [ON] button will switch to AUX or BD in the parameter link group. This will turn fader channels 3/4 off when channels 1/2 are on, and fader channels 3/4 on when channels 1/2 are off. Do not make any changes from this point on.

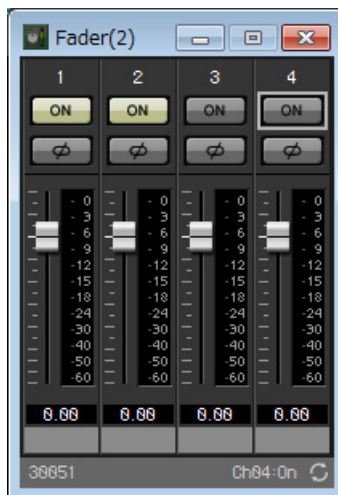

5. Click the [x] button at the top right-hand corner to close the component editor.

■ Encapsulating the Room A components as a block

Since the same components are to be connected for Room B, we'll use the User Defined Block function to make work easier, encapsulating the components as a block.

1. Select the area outside of the input/output components, and select the components and wires.

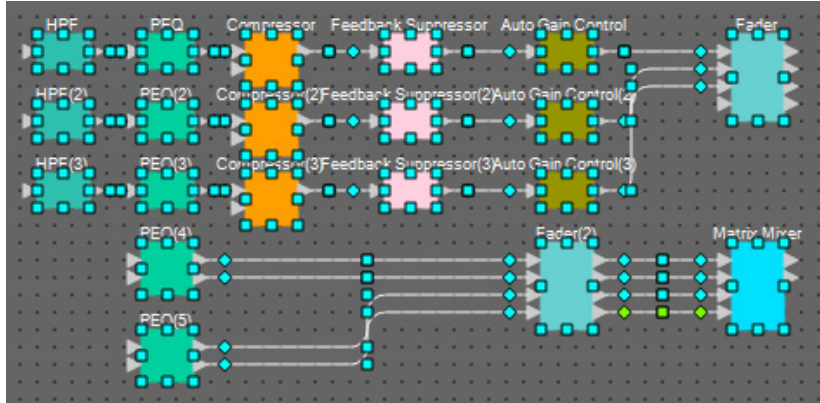

2. Select [Create User Defined Block] in the [Edit] menu. Change the IN value to “7” and the OUT value to “4” in the dialog box, and click [OK].

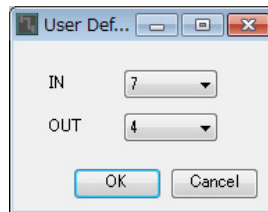

3. Change the position and size of the User Defined Block and the components as necessary.

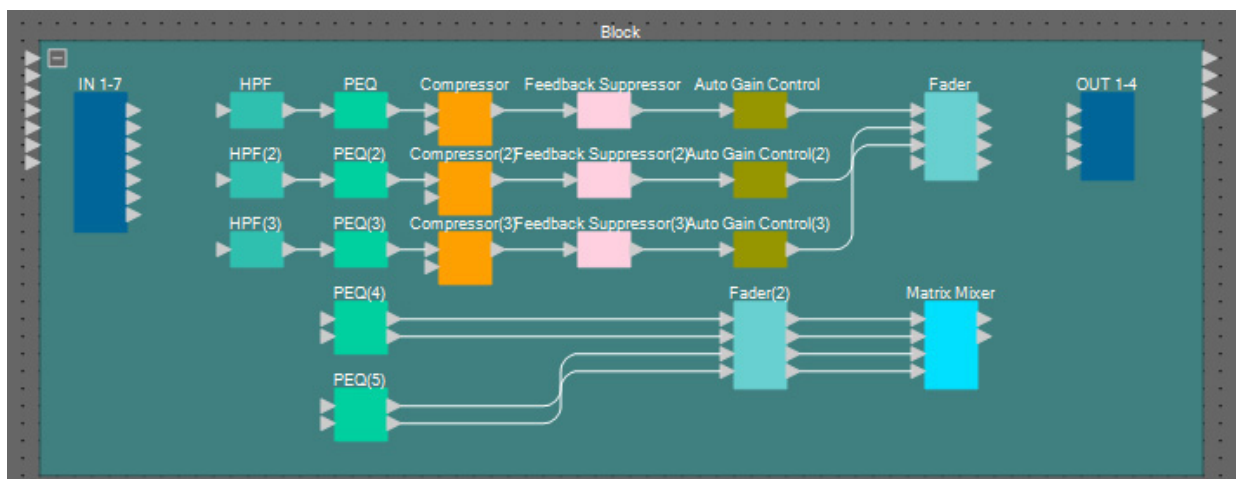

4. Make the following connections with the User Defined Block.

IN	1	HPF	1	Fader	1	OUT	1
	2	HPF(2)	1		2		2
	3	HPF(3)	1		3		3
	4	PEQ(4)	1L	Matrix Mixer	1		4
	5		1R				
	6	PEQ(5)	1L				
	7		1R				

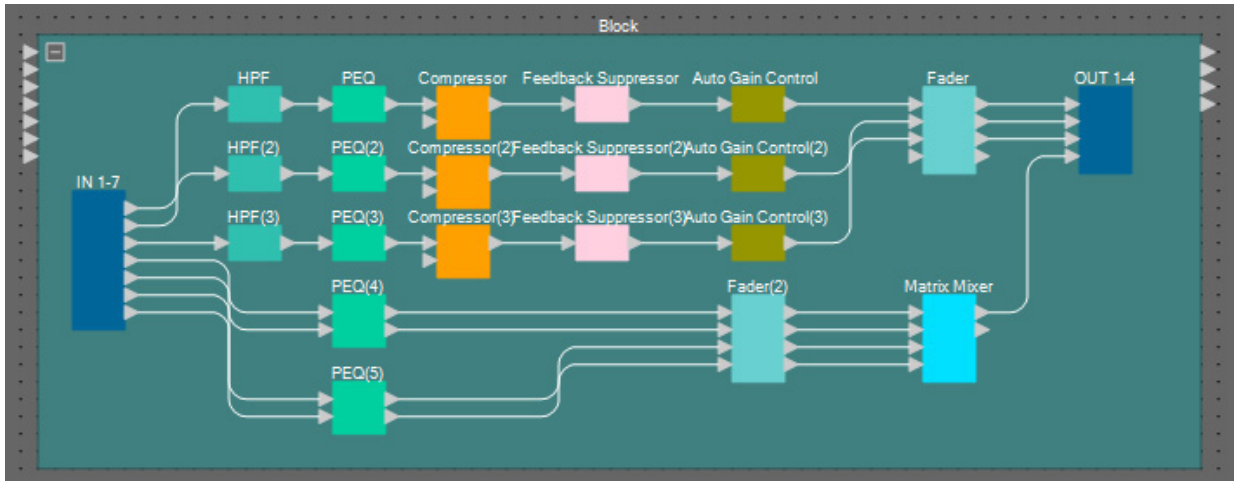

5. Click somewhere besides the User Defined Block components and wires, and select the User Defined Block.

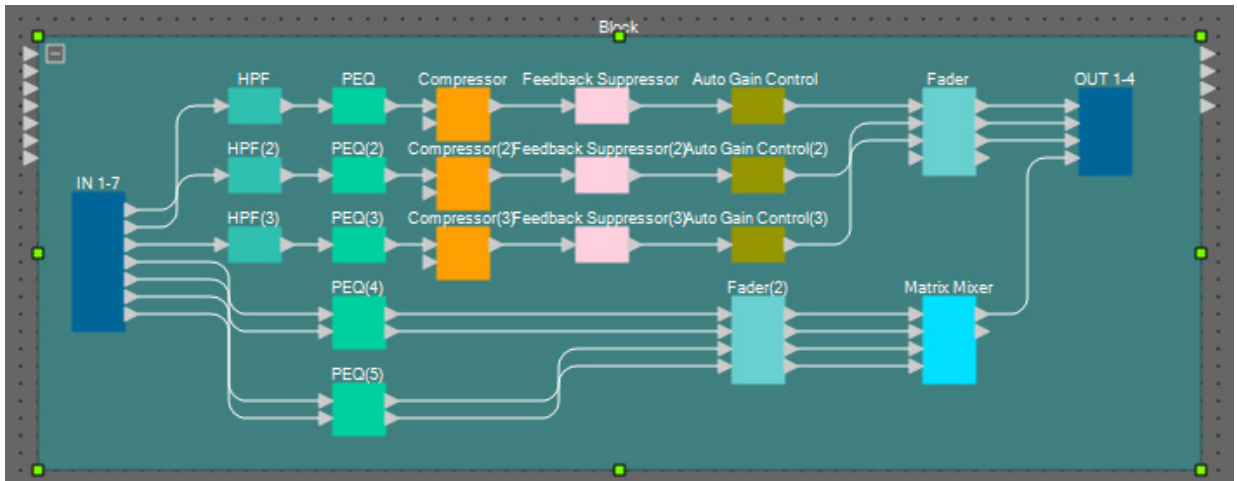

6. Change the name of the User Defined Block using [Label] in the “Properties” area to “Room A.”

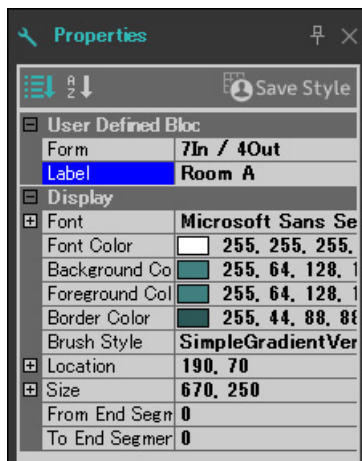

■ Displaying the port name in the input component

To eliminate confusion when making further connections, enter the port name in the “Port Name” dialog box. To open the “Port Name” dialog box, click a port of an input component, and click the button that’s located at the right of the edit area for [Label] in the “Properties” area.

The port names for ANALOG IN can be inputted by double-clicking the component to display the “ANALOG IN” component editor.

In this example, we have used the following port names.

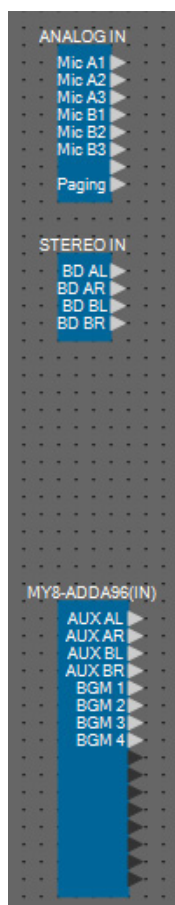

ANALOG IN	1	Mic A1
	2	Mic A2
	3	Mic A3
	4	Mic B1
	5	Mic B2
	6	Mic B3
	8	Paging
	STEREO IN	1L
1R		BD AR
2L		BD BL
2R		BD BR
MY8-ADDA96(IN)	1	AUX AL
	2	AUX AR
	3	AUX BL
	4	AUX BR
	5	BGM 1
	6	BGM 2
	7	BGM 3
	8	BGM 4

■ **Placing and connecting the input-related components that are common to Rooms A/B**

Here we will place and connect the components related to BGM and the paging mic.

1. Place the components shown below by dragging them from the “Components” area and dropping them into the Design sheet.

- “PEQ” (MONO, 4 BAND) × 5
- “Fader” (8 CH)

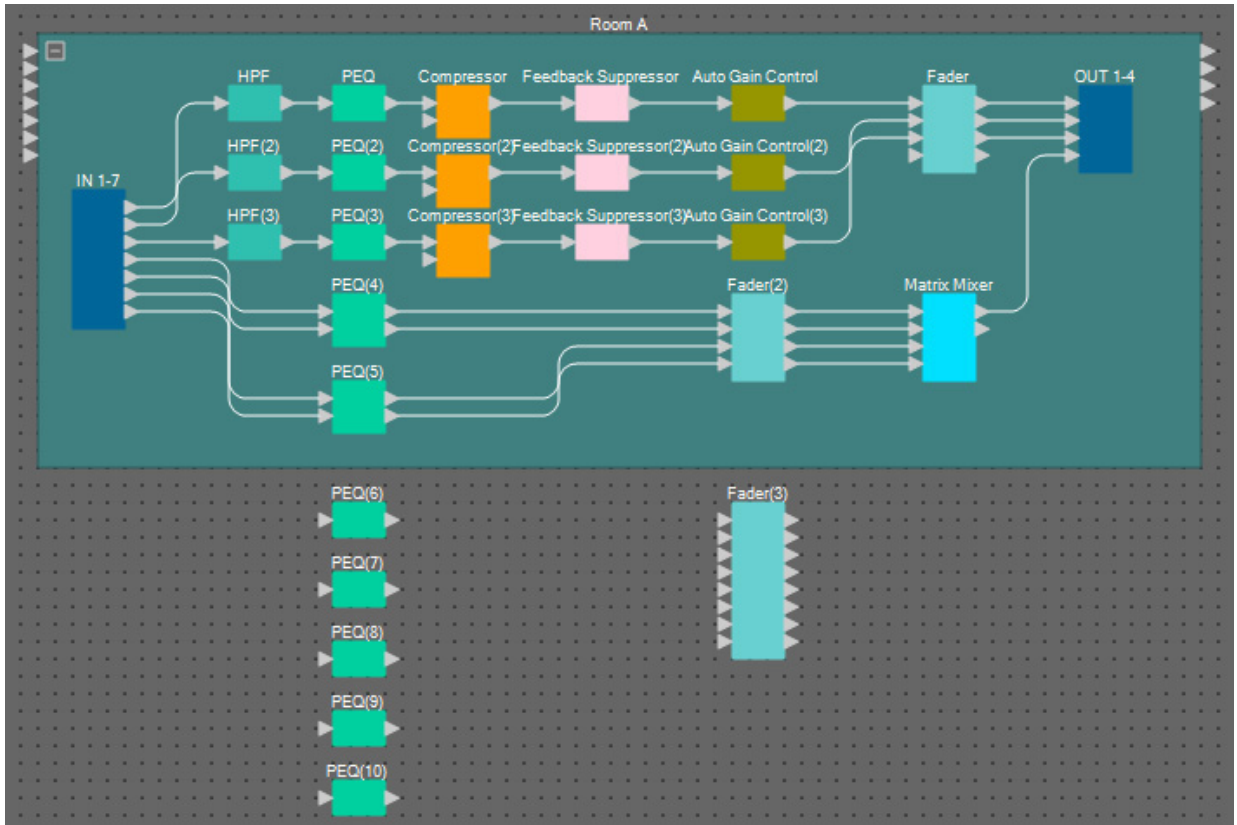

2. Connect each PEQ and fader.

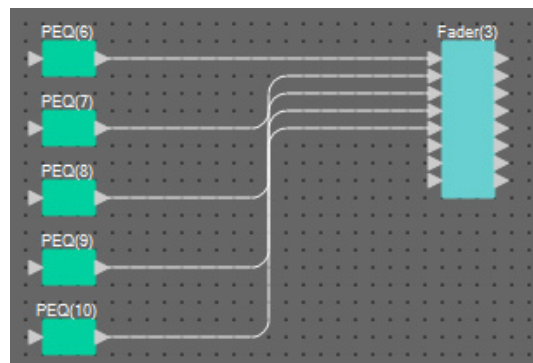

■ Creating Room B

Copy the User Defined Block for Room A to create Room B.

- 1. Click somewhere besides the User Defined Block components and wires of Room A, and select the User Defined Block.

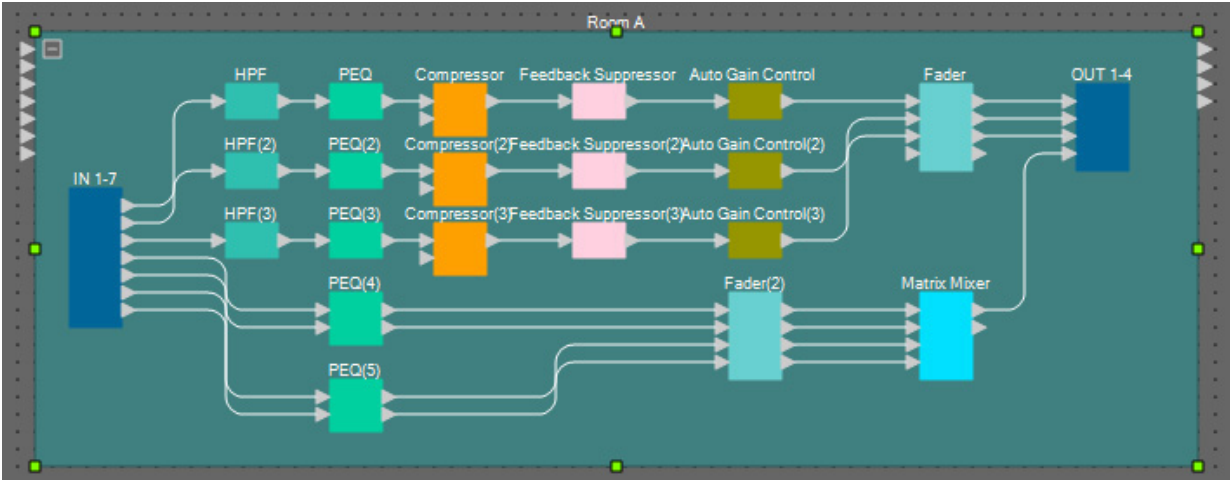

- 2. Drag and drop a User Defined Block while holding down <Ctrl>.

The User Defined Block will be copied to the place where it is dropped.

- 3. Change the position and size of the User Defined Block as necessary.

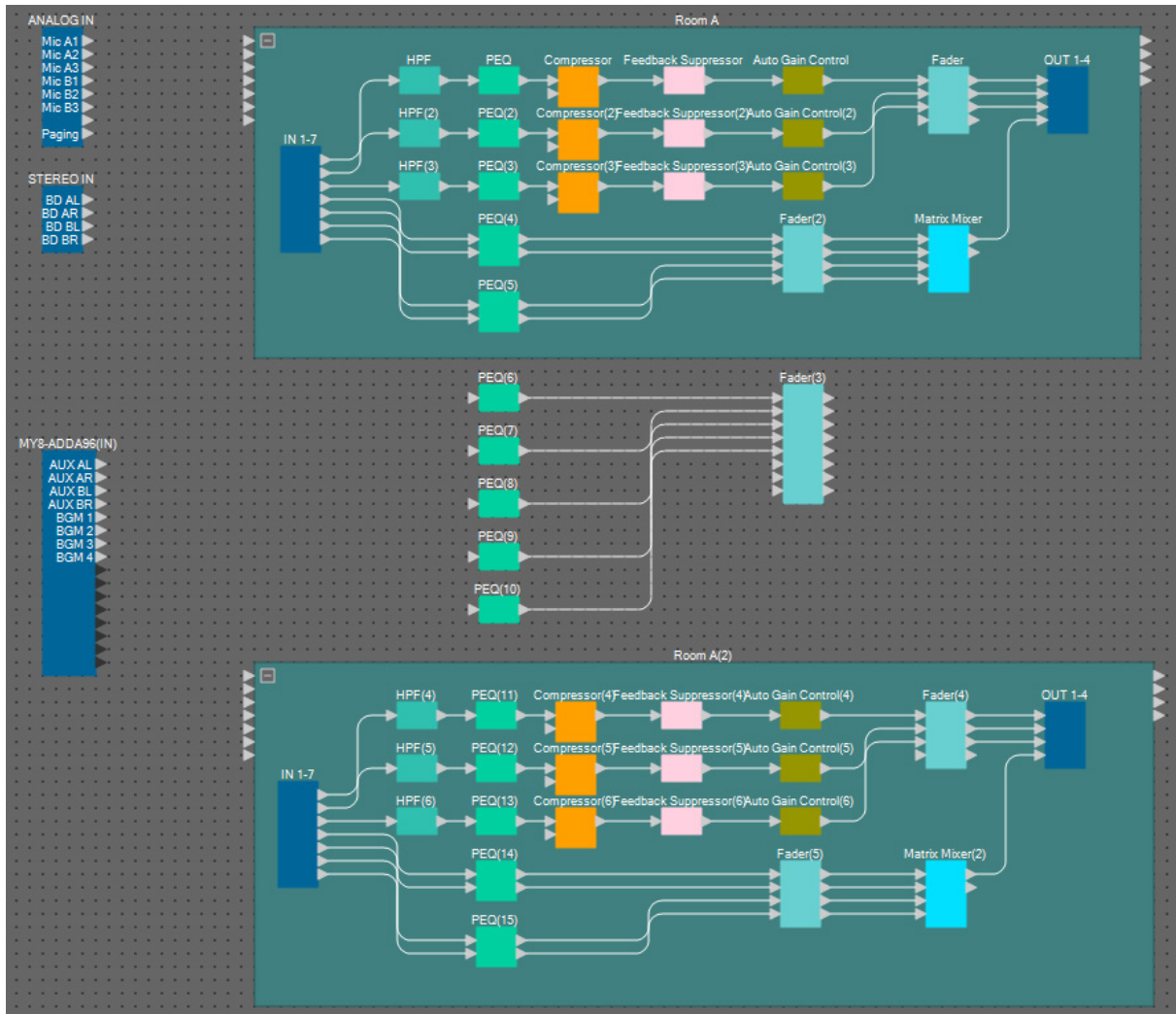

- Change the name of the User Defined Block that you pasted to “Room B”, by using [Label] in the “Properties” area.

■ Connecting to the input components

The input components are connected to other components as shown below.

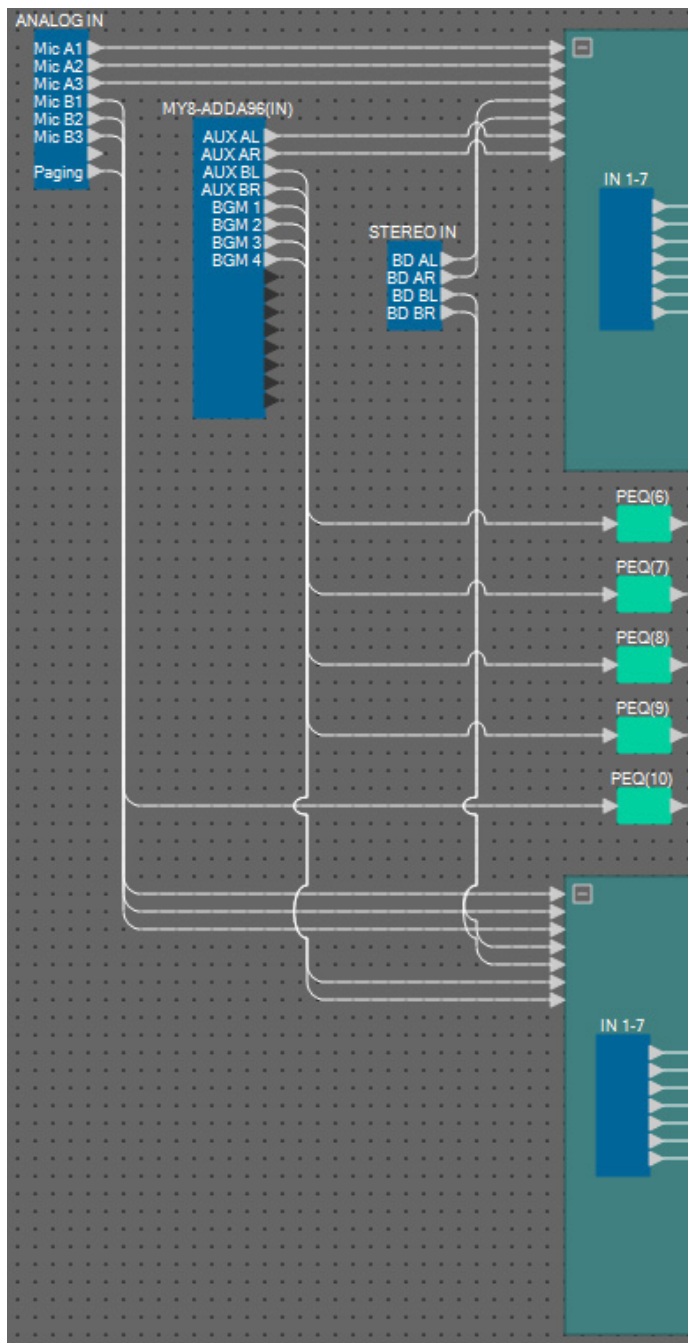

Input components	Port number	Port name	Destination component/ block	Port number
ANALOG IN	1	Mic A1	Room A	1
	2	Mic A2	Room A	2
	3	Mic A3	Room A	3
	4	Mic B1	Room B	1
	5	Mic B2	Room B	2
	6	Mic B3	Room B	3
	8	Paging	PEQ(10)	1
	MY8-ADDA96(IN)	1	AUX AL	Room A
2		AUX AR	Room A	7
3		AUX BL	Room B	6
4		AUX BR	Room B	7
5		BGM 1	PEQ(6)	1
6		BGM 2	PEQ(7)	1
7		BGM 3	PEQ(8)	1
8		BGM4	PEQ(9)	1
STEREO IN	1	BD AL	Room A	4
	2	BD AR	Room A	5
	3	BD BL	Room B	4
	4	BD BR	Room B	5

■ **Placing and connecting the “Room Combiner plus Automixer” component**

Place and connect the “Room Combiner plus Automixer” component, which manages the division and combining of rooms.

- 1. From the “Components” area, drag the “Room Combiner plus Automixer” component and drop it on the design sheet.

The room design dialog box will appear.

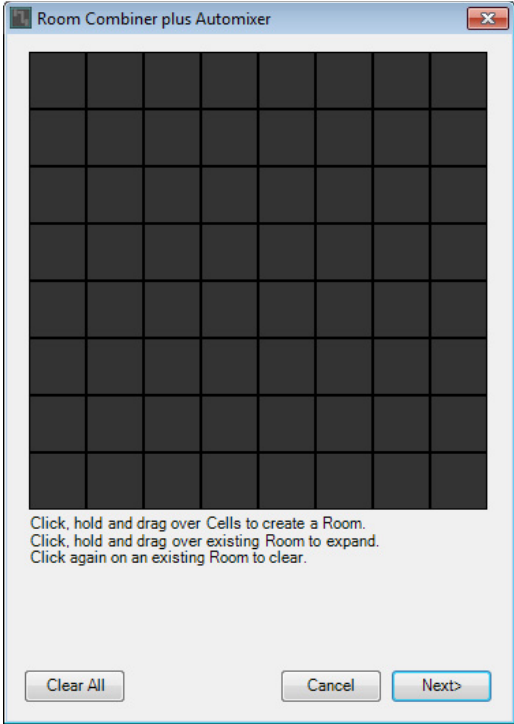

- 2. Drag the cells to create a room, and then click the [Next] button.

This time, we will create two rooms, since we have both Room A and Room B. In this example, each room will take up four cells.

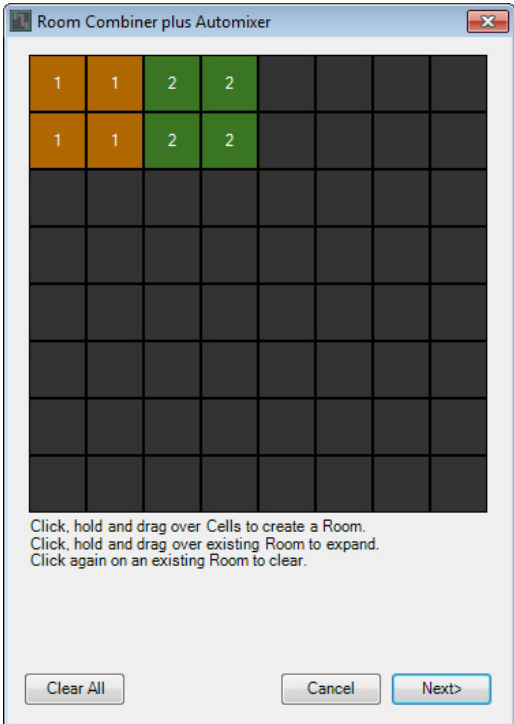

3. Click the rooms and change the numbers as necessary, and then click the [Next] button.

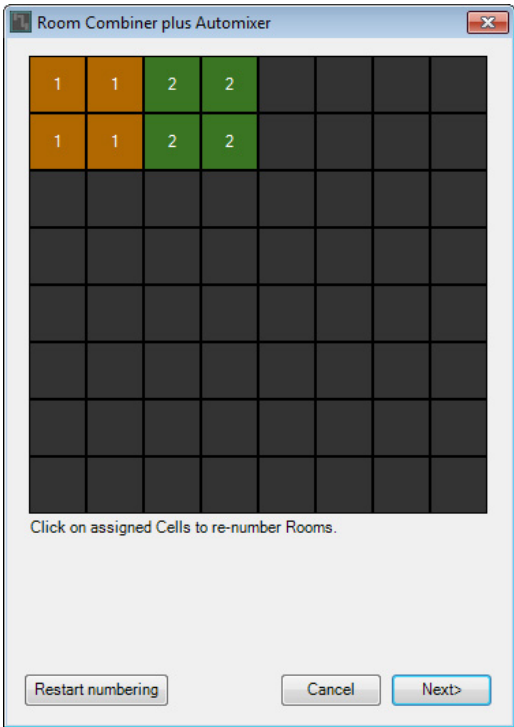

4. Set the [Total Microphones] to [6].

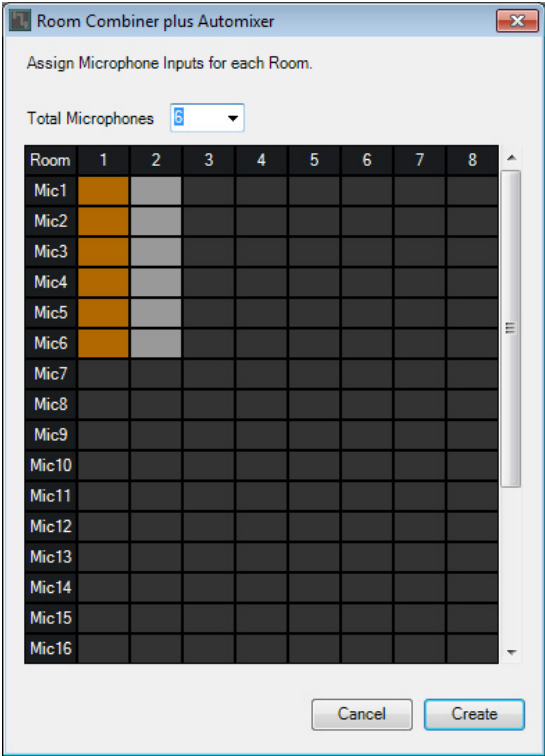

5. Click the spaces to allocate Mic4, Mic5, and Mic6 to Room 2.

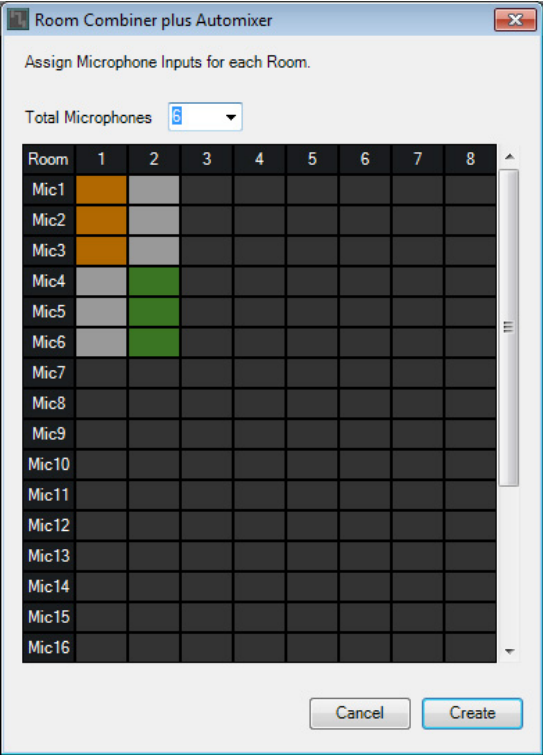

6. Click the [Create] button.

“Room Combiner plus Automixer” is placed in the design sheet.

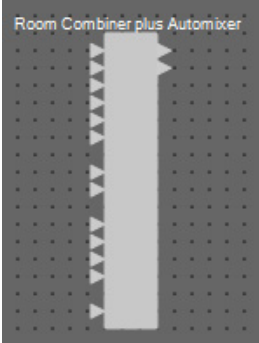

7. Click the “Room Combiner plus Automixer” port, and click the button that’s located at the right of the edit area in “Properties.”

The “Port Name” dialog box will appear.

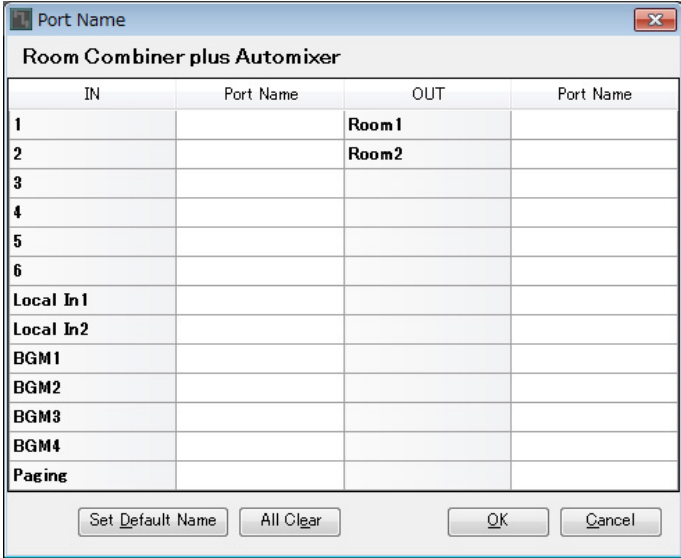

8. Click the [Set Default Name] button.

A default name is entered as the port name.

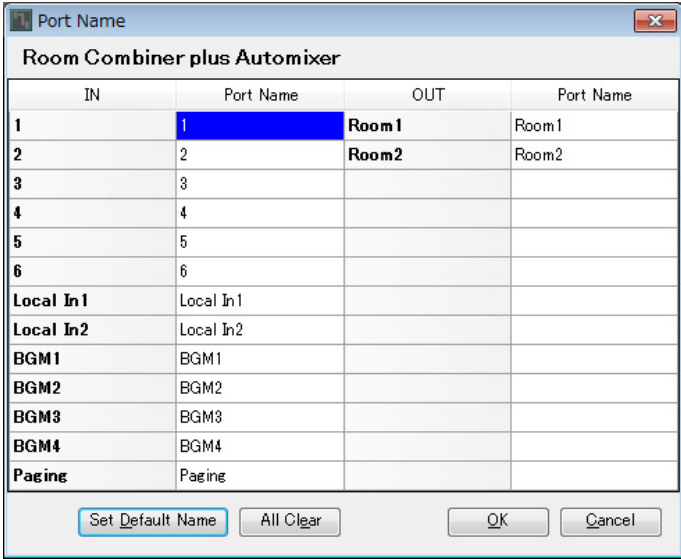

- 9. Change the Room 1 port name to Room A, change the Room 2 port name to Room B, and click the [OK] button.

IN	Port Name	OUT	Port Name
1	1	Room 1	Room A
2	2	Room 2	Room B
3	3		
4	4		
5	5		
6	6		
Local In 1	Local In1		
Local In 2	Local In2		
BGM 1	BGM1		
BGM 2	BGM2		
BGM 3	BGM3		
BGM 4	BGM4		
Paging	Paging		

Buttons: Set Default Name, All Clear, OK, Cancel

10. Make the input connections to the “Room Combiner plus Automixer” as shown below.

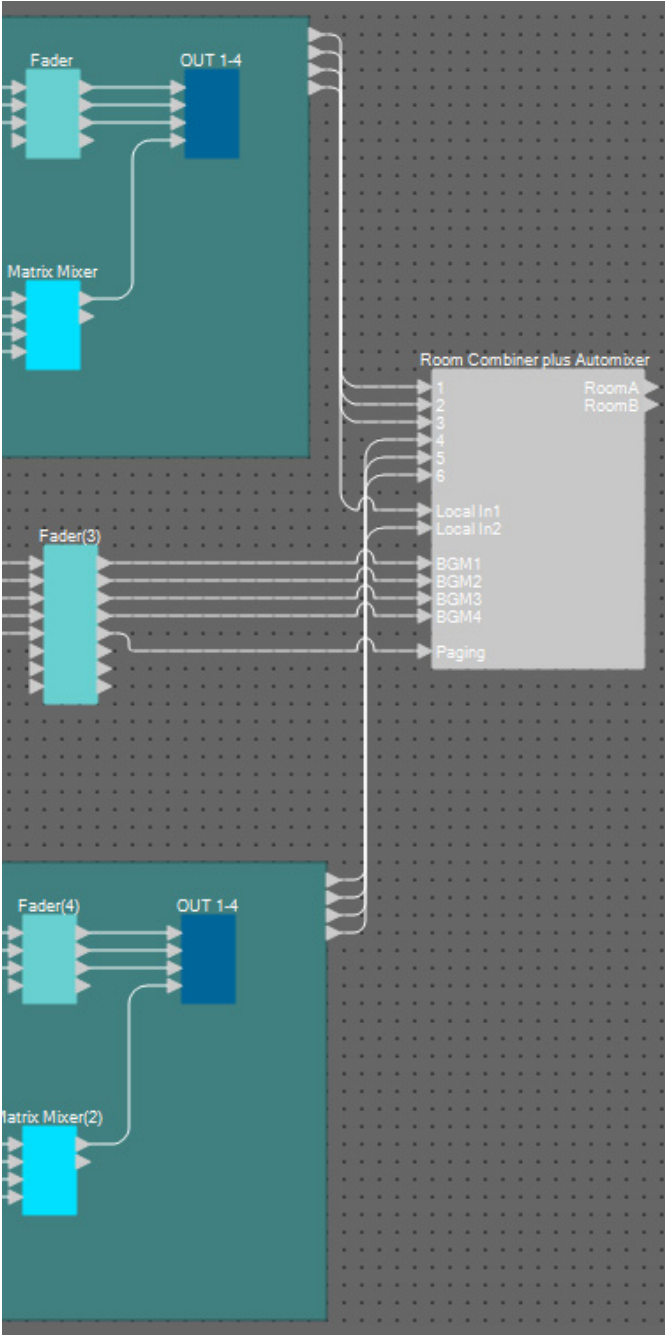

Source component/ block	Port number	Room Combiner plus Automixer input port
Room A	1	1
Room A	2	2
Room A	3	3
Room B	1	4
Room B	2	5
Room B	3	6
Room A	4	Local In1
Room B	4	Local In2
Fader(3)	1	BGM1
Fader(3)	2	BGM2
Fader(3)	3	BGM3
Fader(3)	4	BGM4
Fader(3)	5	Paging

■ **Placing and connecting components from “Room Combiner plus Automixer” to analog outputs**

Here we will place and connect the necessary components from the “Room Combiner plus Automixer” to the analog outputs.

1. Place the components shown below by dragging them from the “Components” area and dropping them into the Design sheet.

- “Fader” (2 CH)
- “PEQ” (MONO, 6 BAND) × 2
- “Speaker Processor” (1 Way) × 2
- “ANALOG OUT”

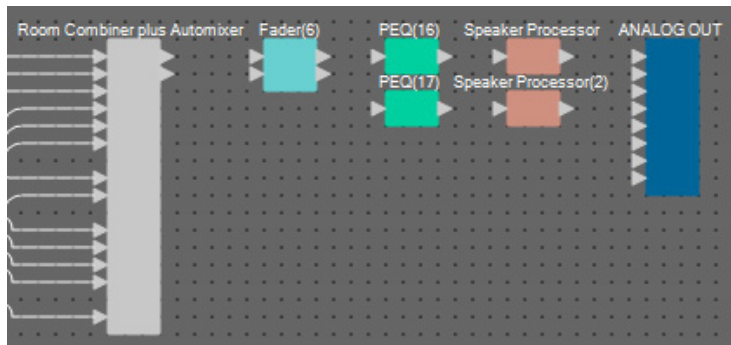

2. Make the connections from the “Room Combiner plus Automixer” to the “ANALOG OUT.”

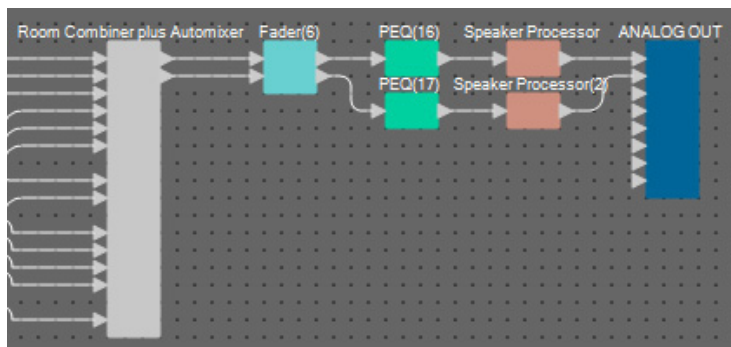

3. Double-click “ANALOG OUT.”

The “ANALOG OUT” component editor will appear.

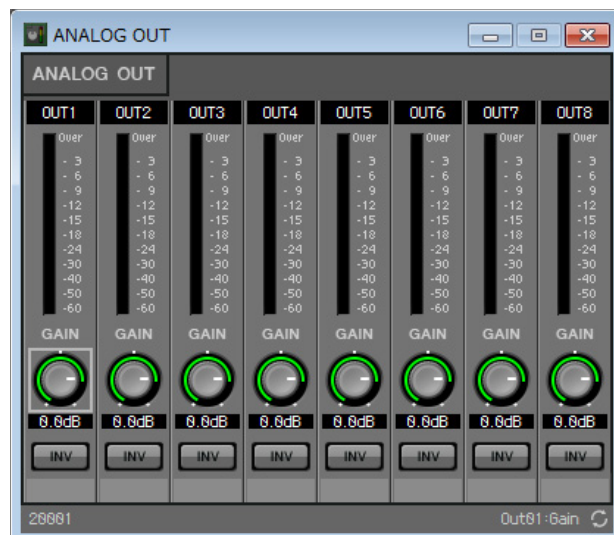

4. Set the port name of OUT 1 to “Room A,” and the port name of OUT 2 to “Room B.”

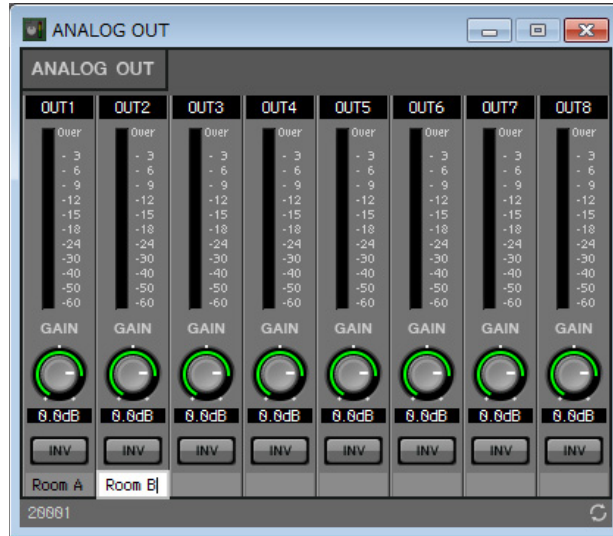

5. Click the [x] button at the top right-hand corner to close the component editor.

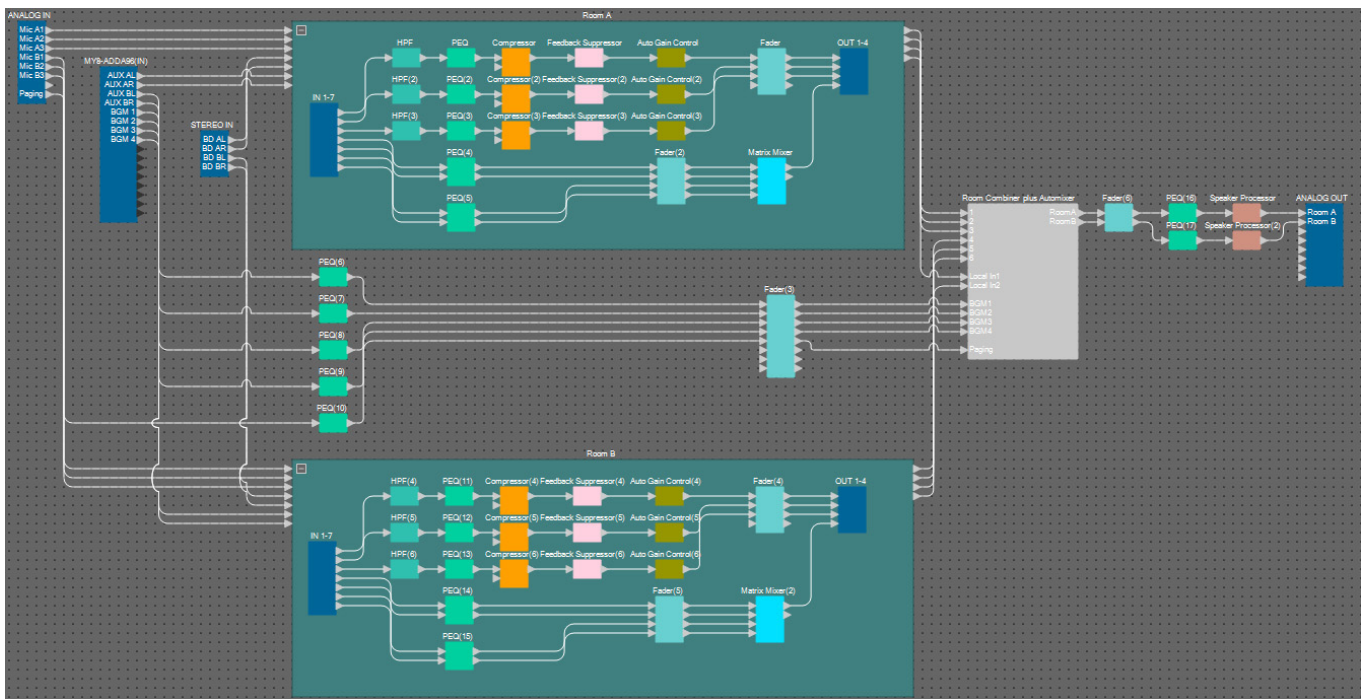

Now you're finished placing and connecting the components. Change the placement of the components and change the wiring as need be.

Compiling

This analyzes the placement and wiring of the components in the MRX, to determine whether there are any problems.

1. Click the [Compile] tool button ( Compile).

Start the analysis.

2. Confirm the analysis results.

If the message “Completed successfully” is displayed in the “Message” field, there were no problems.

If a problem was detected, click the [Detail] button to check how to solve the problem and to correct it.

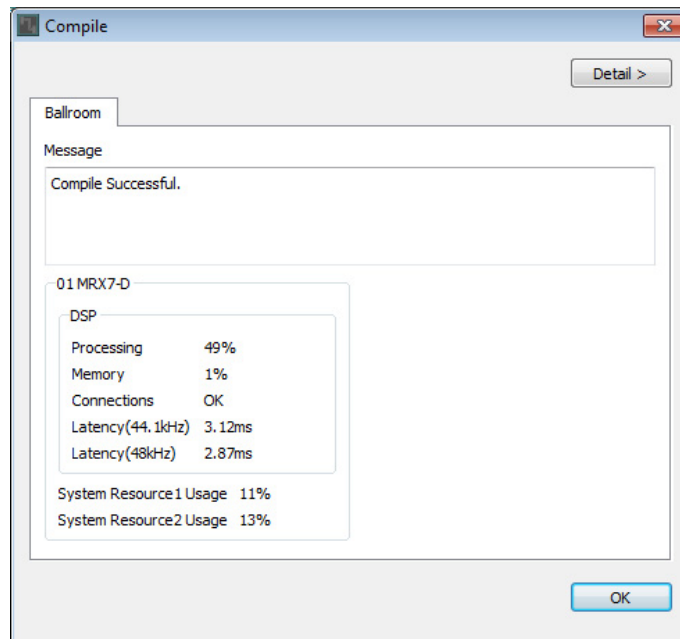

Now you're finished compiling.

Specifying snapshots

In this example, we'll operate a DCP switch to switch between split and combined rooms. Although you can simply recall the presets for split rooms and for combined rooms respectively, you can make quicker changes to the settings just by turning the Combine button in the "Room Combiner plus Automixer" editor on and off, rather than recalling all of the parameters.

Now, we'll explain how to create a snapshot.

1. Open the "Parameter Sets" area on the left side of the MRX Designer.

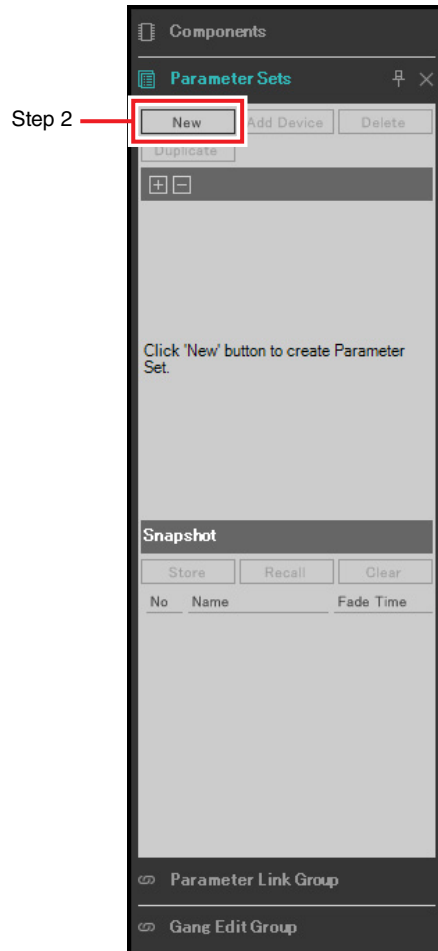

2. Click the [New] button.

A dialog box for setting the parameter set name will appear.

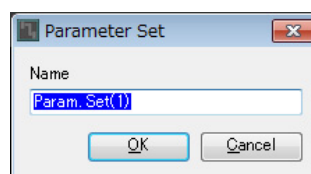

3. Input [Room Combine] and click the [OK] button.

A parameter set named “Room Combine” will display in the “Parameter Sets” area.

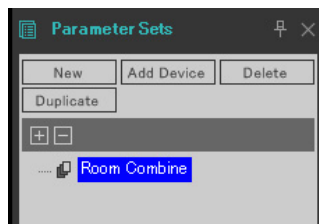

4. Double-click “Room Combiner plus Automixer.”

The “Room Combiner plus Automixer” component editor will appear.

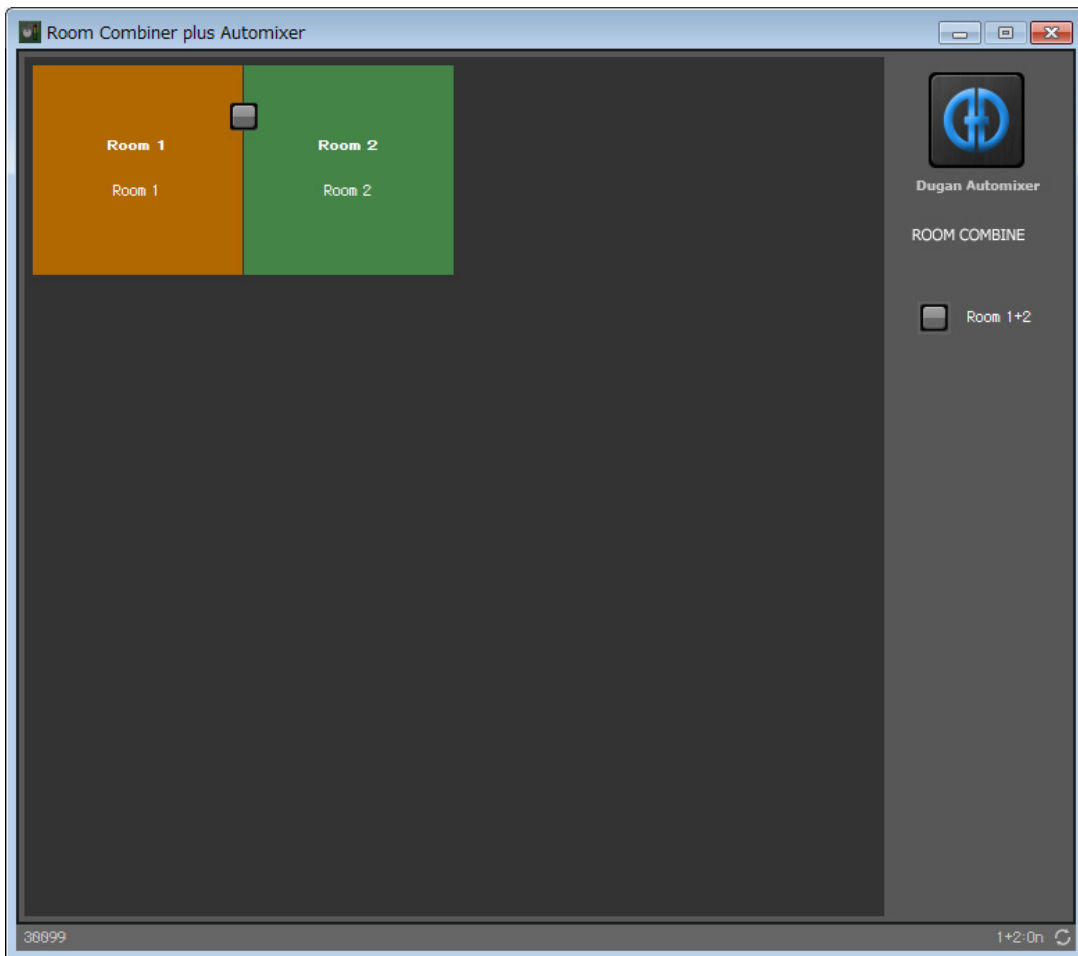

- While holding down <Ctrl>, drag and drop the [Room 1+2] button () into [Room Combine] in the “Parameter Sets” area.

The parameters for 1+2 will be registered in the “Room Combine” parameter set.

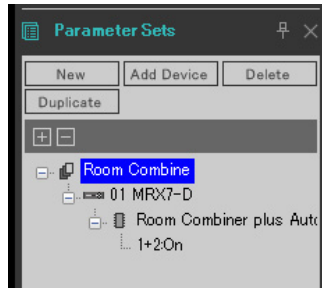

- To create a snapshot of the split rooms with the Room Combiner, click on “Snapshot” number 01, while the rooms are two different colors in the “Room Combiner plus Auto-mixer” component editor.



- Click the [Store] button.

A dialog box for setting the snapshot name will appear.

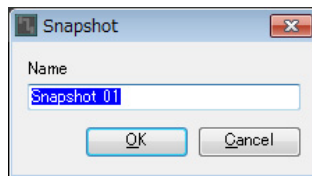

- Input [Split] and click the [OK] button.

A snapshot named [Split] will display in “Snapshot.”

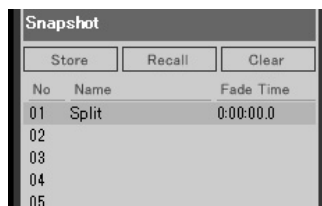

- To create a snapshot of the combined rooms with the Room Combiner, click the [Room 1+2] button () in the “Room Combiner plus Automixer” component editor.

The rooms will be combined.

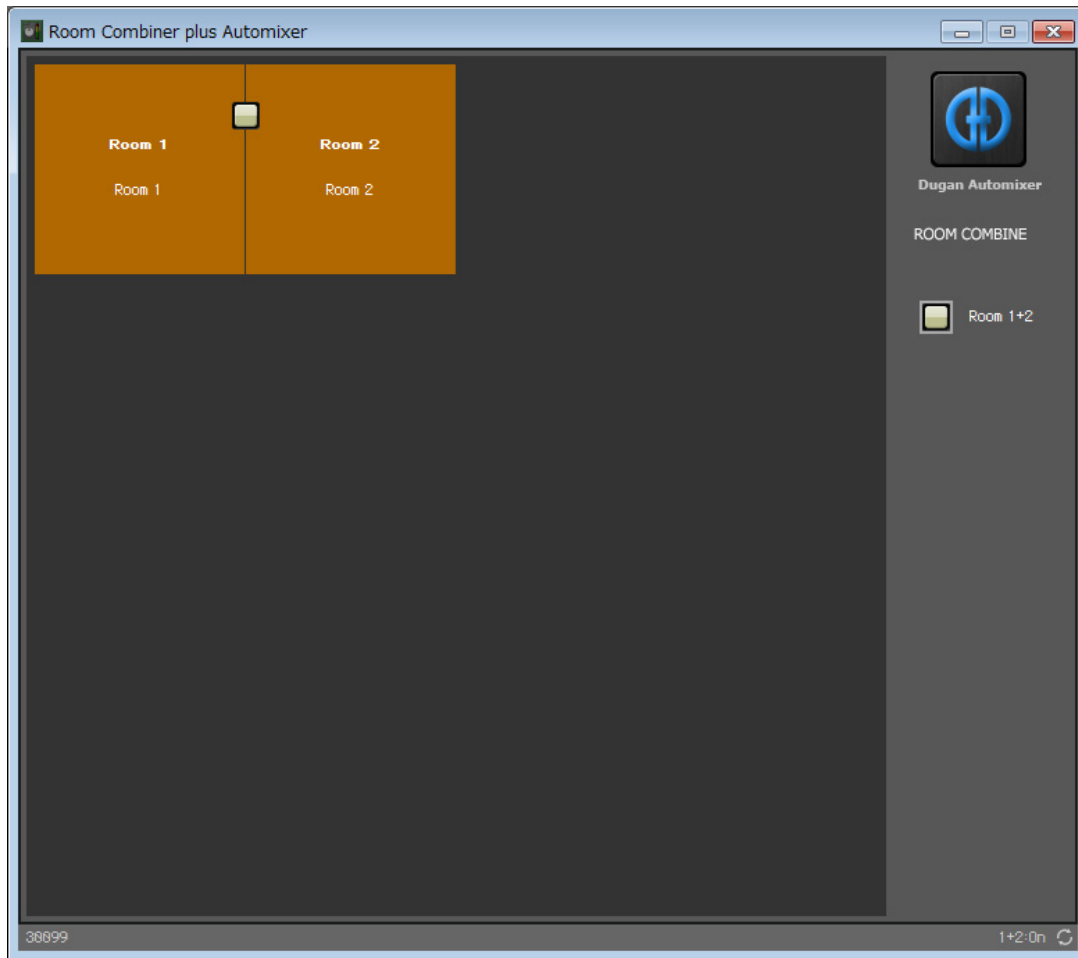

- Click on “Snapshot” number 02, while the rooms are the same color in the “Room Combiner plus Automixer” component editor.

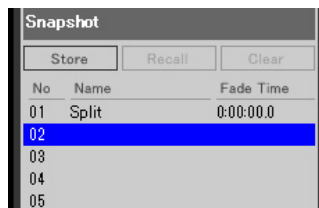

- Click the [Store] button.

A dialog box for setting the snapshot name will appear.

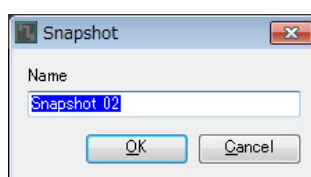

12. Input [Combined] and click the [OK] button.

A snapshot named [Combined] will display in “Snapshot.”



Snapshot		
Store	Recall	Clear
No	Name	Fade Time
01	Split	0:00:00.0
02	Combined	0:00:00.0
03		
04		
05		

Now you're finished setting the snapshots. When you recall the [Split] snapshot, the room will be split; and when you recall the [Combined] snapshot, the rooms will be combined.

Setting a parameter link group

In this example, we'll see how we can avoid the unnecessary use of DCP switches and knobs, such as by assigning a single fader to a stereo pair of inputs (such as a Blu-Ray player or AUX In), or by making a single ON button for both L and R. Here we'll create a parameter link group that links multiple parameters such as levels or ON/OFF, so that we can change multiple parameters at the same time with a DCP knob or button.

As with snapshots, parameter link groups are registered by dragging and dropping while holding down <Ctrl>. However, in this example we will use a different method, since there are a total of 24 parameters to change. The same operation can be used with snapshots.

1. Open the “Parameter Link Group” area on the left side of the MRX Designer, in order to check the parameters that are registered.

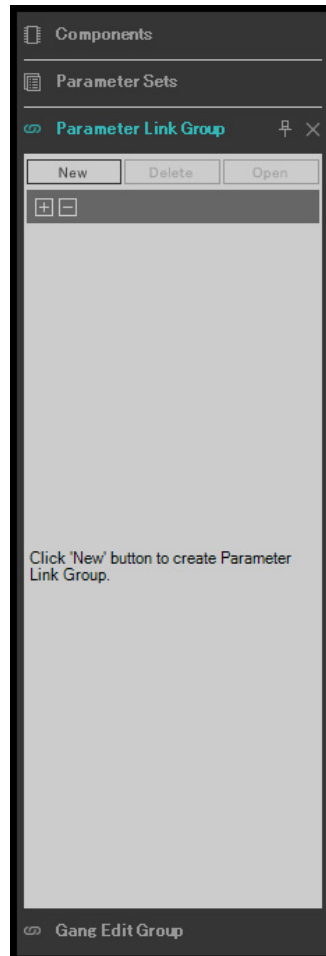

2. Open the “Parameter” area on the right side of the MRX Designer.

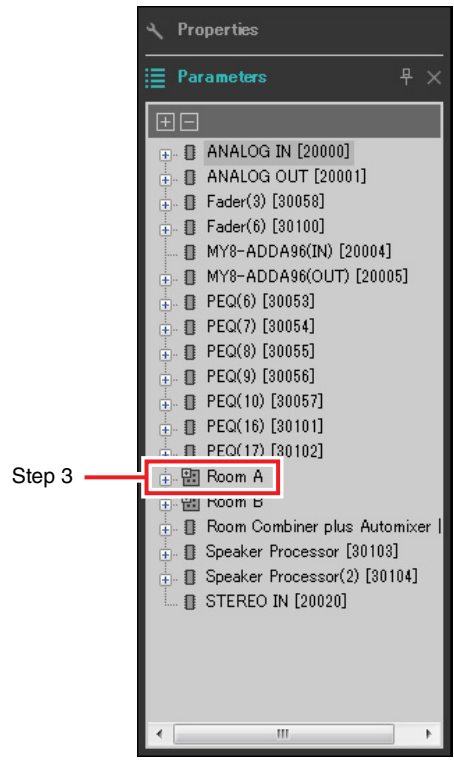

3. Since the AUX level of Room A is adjusted using “Fader(2)” of Room A, open [Room A] → [Fader(2)] in the “Parameters” area.

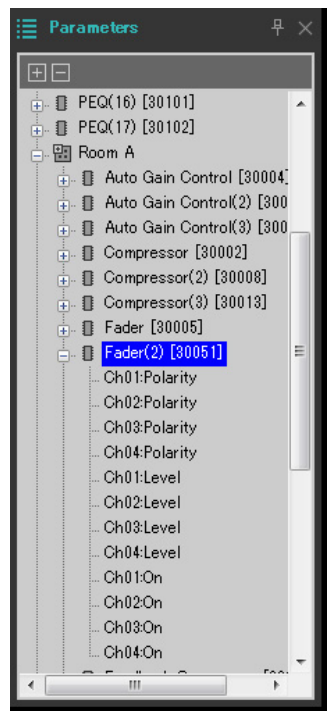

4. After clicking [Ch03:Level], hold down <Ctrl> and click [Ch04:Level].

You can select multiple items while holding down <Ctrl> and clicking.

To select continuous parameters, click the start parameter, hold down the <Shift> and then click on the end parameter.

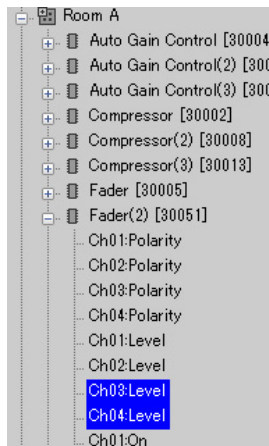

5. Do a right-click and select [Add to Parameter Link Group] → [Add New Group].

A dialog box for setting the parameter link group name will appear.

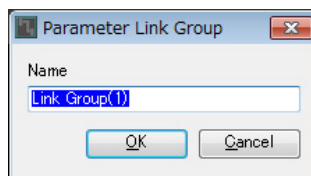

6. Input [RoomA Aux Level] and click the [OK] button.

The [Room A Aux Level] group will be generated in the “Parameter Link Group” area, and the Link Master editor will appear.

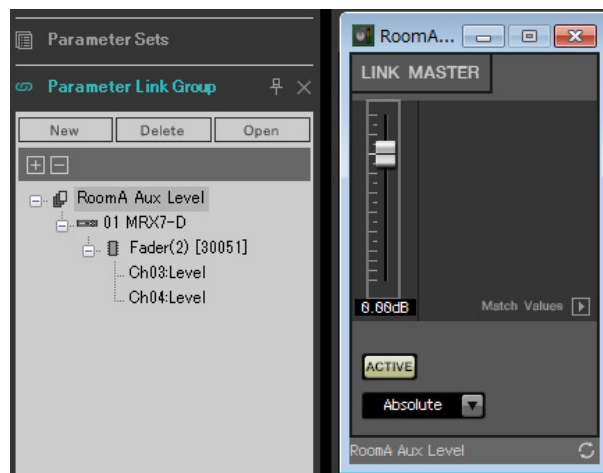

7. Select [Absolute] on the Link Master editor combo box.

8. Double-click “Fader(2)” for Room A.

The “Fader(2)” component editor will appear.

9. Move the fader in the Link Master editor, and confirm that channels 3 and 4 in the “Fader(2)” component editor are linked together.

10. Click the [x] buttons at the top right-hand corner of the Link Master editor and the “Fader(2)” component editor to close the editor and component editor.

Repeat step 2 through 10 to create the following parameter link groups.

Parameter link group name	Components	Parameters	Link Master editor combo box settings
RoomA BD Level	[Room A] → [Fader(2)]	Ch01:Level	Absolute
		Ch02:Level	
RoomA BD-AUX On/Off	[Room A] → [Fader(2)]	Ch01:On	Opposite
		Ch02:On	
		Ch03:On	
		Ch04:On	
RoomA Matrix On/Off	[Room A] → [Matrix Mixer]	In01Out01:On	Equal
		In02Out01:On	
		In03Out01:On	
		In04Out01:On	
RoomB Aux Level	[Room B] → [Fader(5)]	Ch03:Level	Absolute
		Ch04:Level	
RoomB BD Level	[Room B] → [Fader(5)]	Ch01:Level	Absolute
		Ch02:Level	
RoomB BD-AUX On/Off	[Room B] → [Fader(5)]	Ch01:On	Opposite
		Ch02:On	
		Ch03:On	
		Ch04:On	
RoomB Matrix On/Off	[Room B] → [Matrix Mixer(2)]	In01Out01:On	Equal
		In02Out01:On	
		In03Out01:On	
		In04Out01:On	

This parameter link group switches [Room BD-AUX On/Off] to either AUX or BD. This will turn fader channels 3/4 off when channels 1/2 are on, and fader channels 3/4 on when channels 1/2 are off.

Now you’re finished setting the parameter link group.

Making the DCP settings

Allocates parameters to the DCP4V4S and DCP4S in each room, so that they can be changed by operating a switch or knob.

Set the library name to “Room Split” if the room is split, and to “Room Combine” if the rooms are combined.

Allocate the following parameters to the switches and knobs. (The steps for allocating parameters will be explained later.)

● “Room Split” parameters

DCP	Switch/knob	Component, snapshot, or parameter link group that includes the set parameter	Parameters
DCP4V4S for Room A	Switch 1	Room Combiner plus Automixer	Mics [ON] button for Room 1
	Switch 2	Room Combiner plus Automixer	BGM [ON] button for Room 1
	Switch 3	RoomA BD-AUX On/Off for parameter link group	[ON] button for Link Master
	Switch 4	RoomA Matrix On/Off for parameter link group	[ON] button for Link Master
	Knob 1	Room Combiner plus Automixer	Mics knob for Room 1
	Knob 2	Room Combiner plus Automixer	BGM knob for Room 1
	Knob 3	RoomA BD Level for parameter link group	Link Master fader
	Knob 4	RoomA Aux Level for parameter link group	Link Master fader
DCP4S for Room A	Switch 1	Preset	01 Split *
	Switch 2	Preset	02 Combine *
	Switch 3	Room Combiner plus Automixer	Room 1 BGM list (Inc/Upper Limit=4)
	Switch 4	Room Combiner plus Automixer	Room 1 BGM list (Dec)
DCP4V4S for Room B	Switch 1	Room Combiner plus Automixer	Mics [ON] button for Room 2
	Switch 2	Room Combiner plus Automixer	BGM [ON] button for Room 2
	Switch 3	RoomB BD-AUX On/Off for parameter link group	[ON] button for Link Master
	Switch 4	RoomB Matrix On/Off for parameter link group	[ON] button for Link Master
	Knob 1	Room Combiner plus Automixer	Mics knob for Room 2
	Knob 2	Room Combiner plus Automixer	BGM knob for Room 2
	Knob 3	RoomB BD Level for parameter link group	Link Master fader
	Knob 4	RoomB Aux Level for parameter link group	Link Master fader
DCP4S for Room B	Switch 1	Preset	01 Split *
	Switch 2	Preset	02 Combine *
	Switch 3	Room Combiner plus Automixer	Room 2 BGM list (Inc/Upper Limit=4)
	Switch 4	Room Combiner plus Automixer	Room 2 BGM list (Dec)

* The preset has not been configured at this time, so only the preset number is displayed. By recalling the preset, you will be able to tell which preset was recalled by looking at the indicator on the DCP4S switch. (When using the DCP switch to switch the Combine button on and off, you won't be able to tell whether it is on or off just by looking at the DCP.)

For the “Room Combine” parameters, use the “Room Split” parameters, but change the red characters to “1” or “A.”

Now, we'll explain how to set the parameters for switch 1 (parameter) of the DCP4V4S, and for switch 1 (preset) of the DCP4S in Room A. This time, we'll explain how to do this by dragging and dropping the parameters while holding <Ctrl> using the component editor and so on; but you can also drag and drop from the “Parameters” area while holding <Ctrl>.

1. Select [Digital Control Panel] from the [Controller] menu.

The “Digital Control Panel” dialog box will appear.

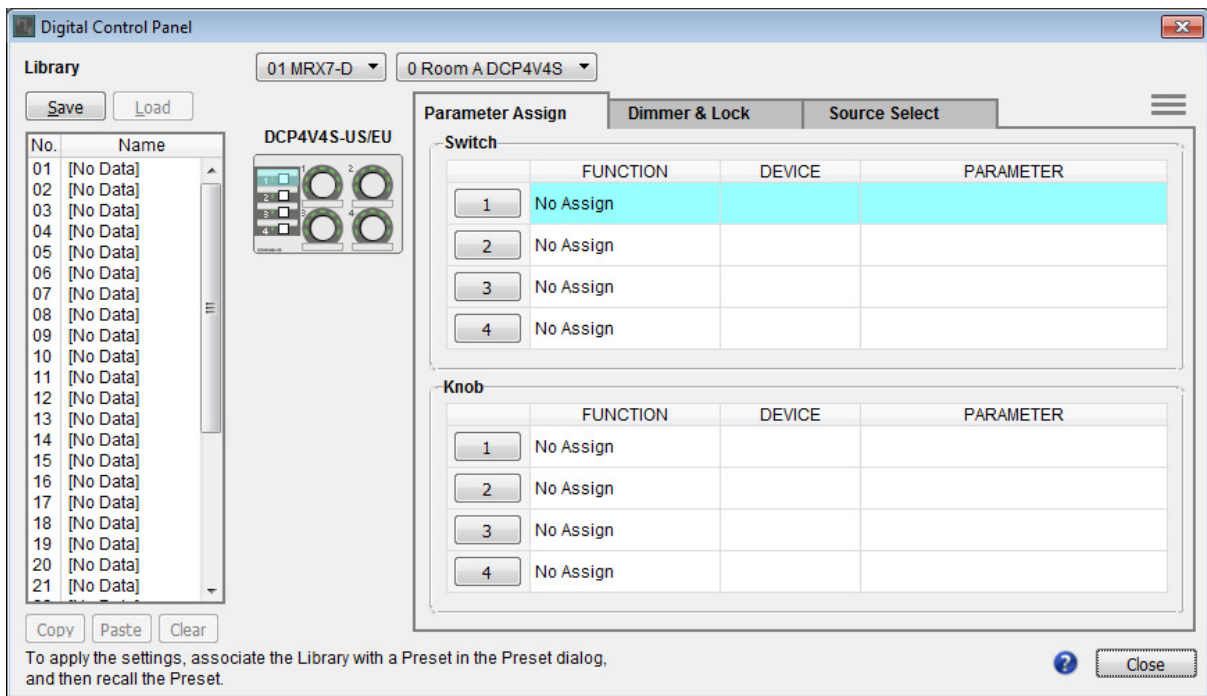

2. Double-click “Room Combiner plus Automixer.”

The “Room Combiner plus Automixer” editor will appear.

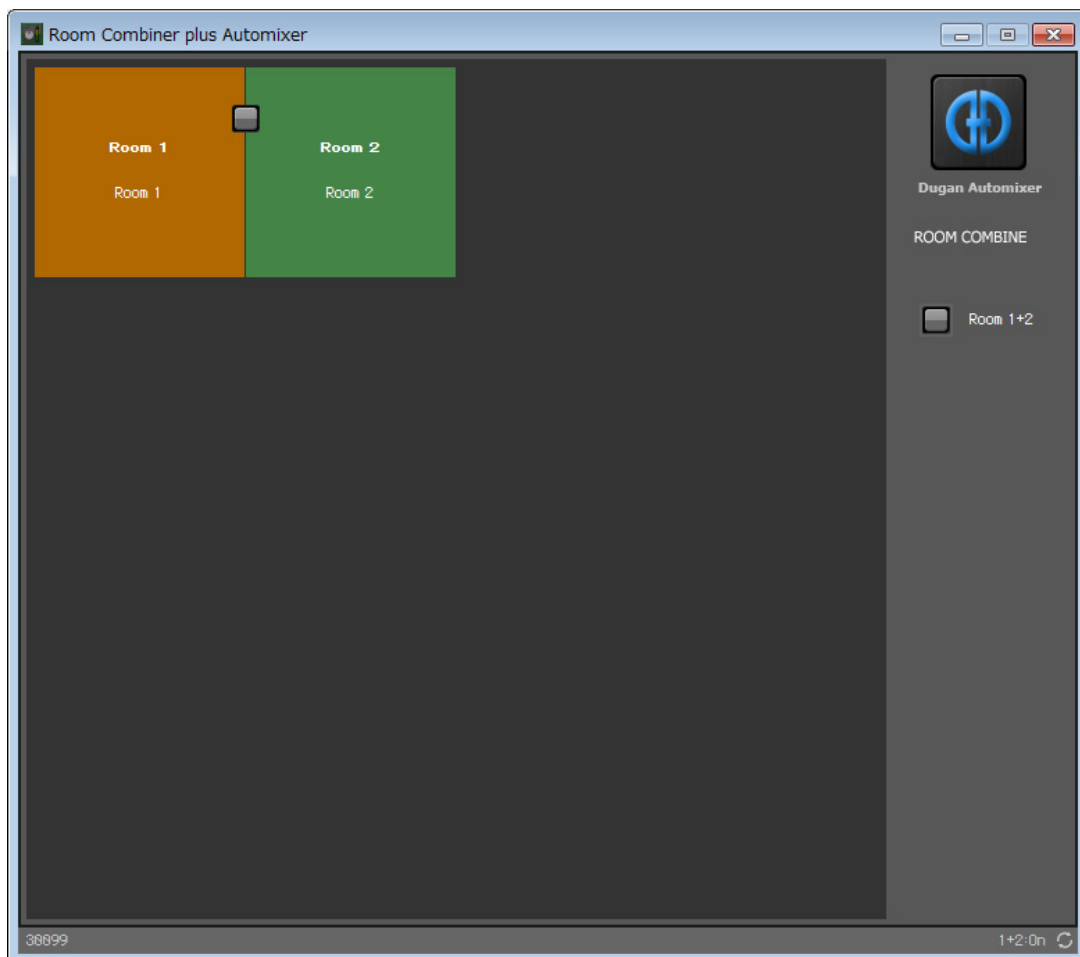

3. Double-click “Room 1” or “Room 2.”

The Combiner parameter setting window will appear.



4. Turn all of the [ON] buttons on.

Since the buttons are off by default, you will not be able to hear any sound.



5. Click the “Switch” [1] button on the “Digital Control Panel” dialog box.

The “Settings” dialog box will appear.

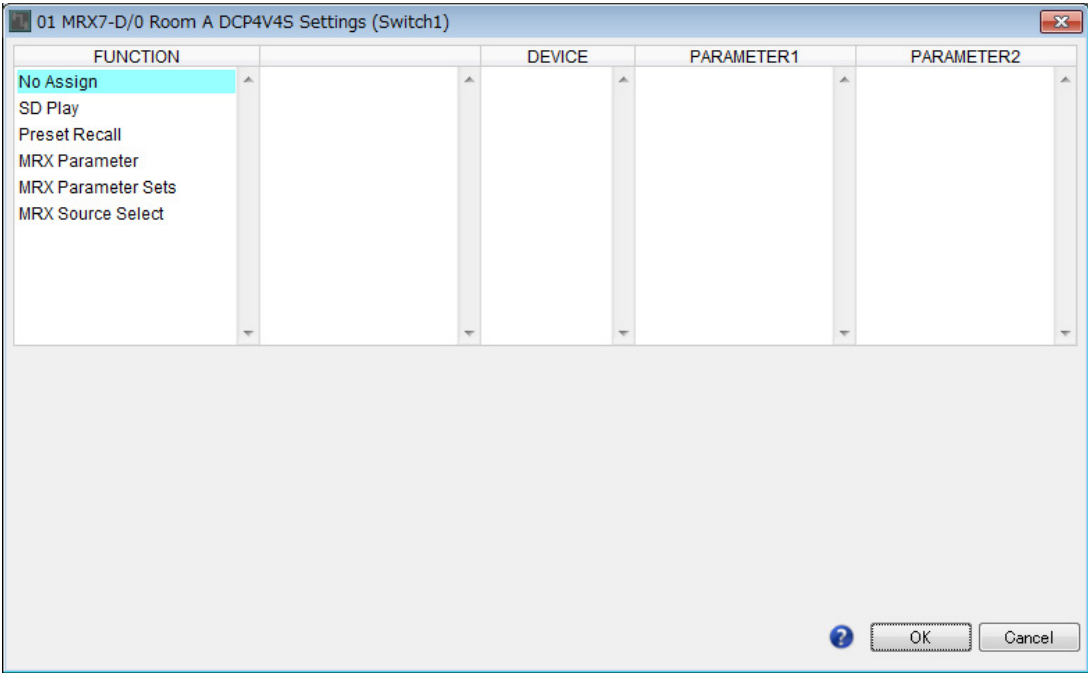

6. Click [MRX Parameter] under “FUNCTION.”

The screen changes to a screen where you can register the [MRX Parameter].

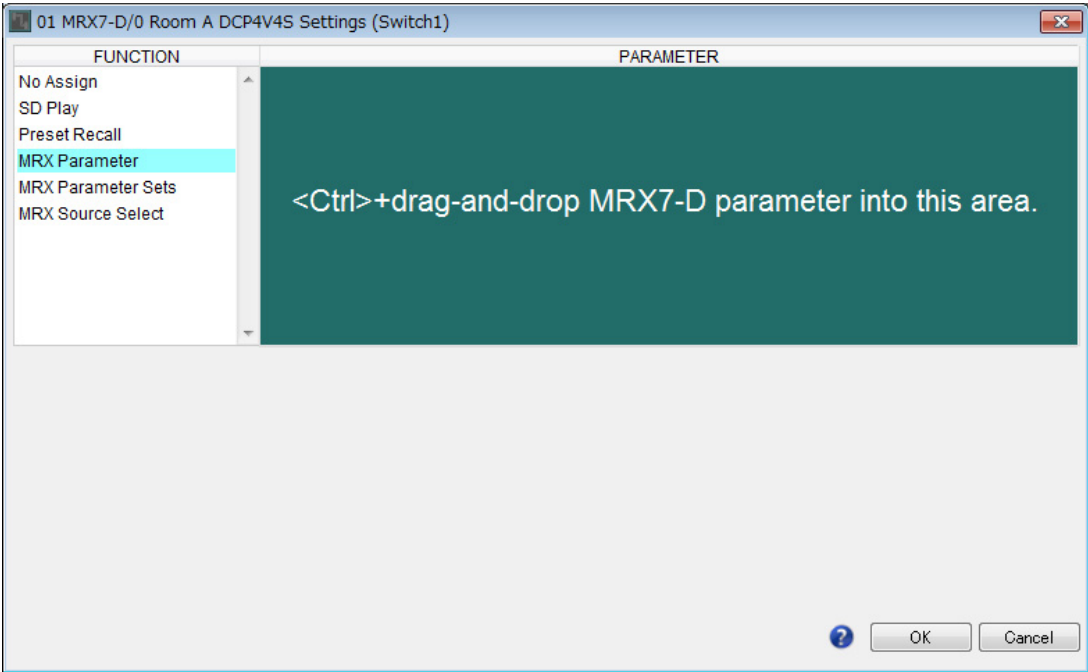

7. Drag and drop the Mics [ON] button for Room 1 in the Combiner parameter settings window to the “PARAMETER” area in the “Settings” dialog box, while holding down <Ctrl>.

This will register the Mics [ON] button for Room 1.



8. Click the [OK] button.

The “Digital Control Panel” dialog box will be displayed, with the Mics [ON] button for Room 1 registered.

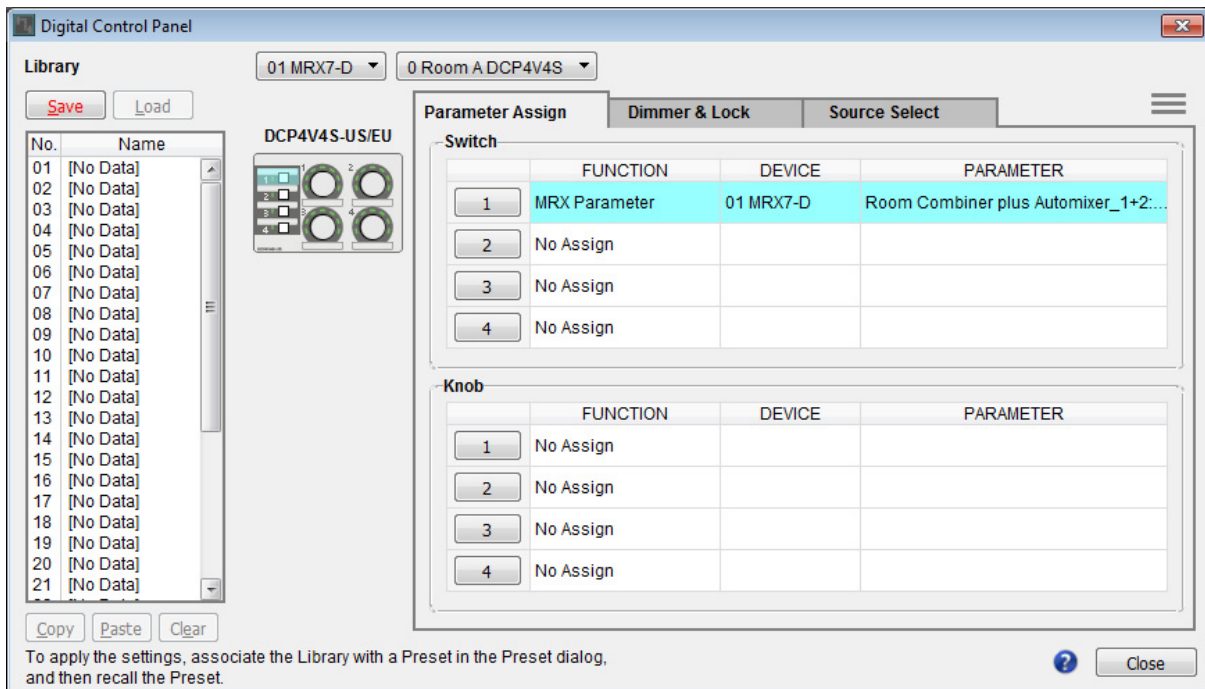

9. Register the other parameters as shown in steps 2 through 7.

The Link Master editor for the parameter link group can be displayed by right-clicking on the parameter link group and selecting [Open Link Master] from the context menu.

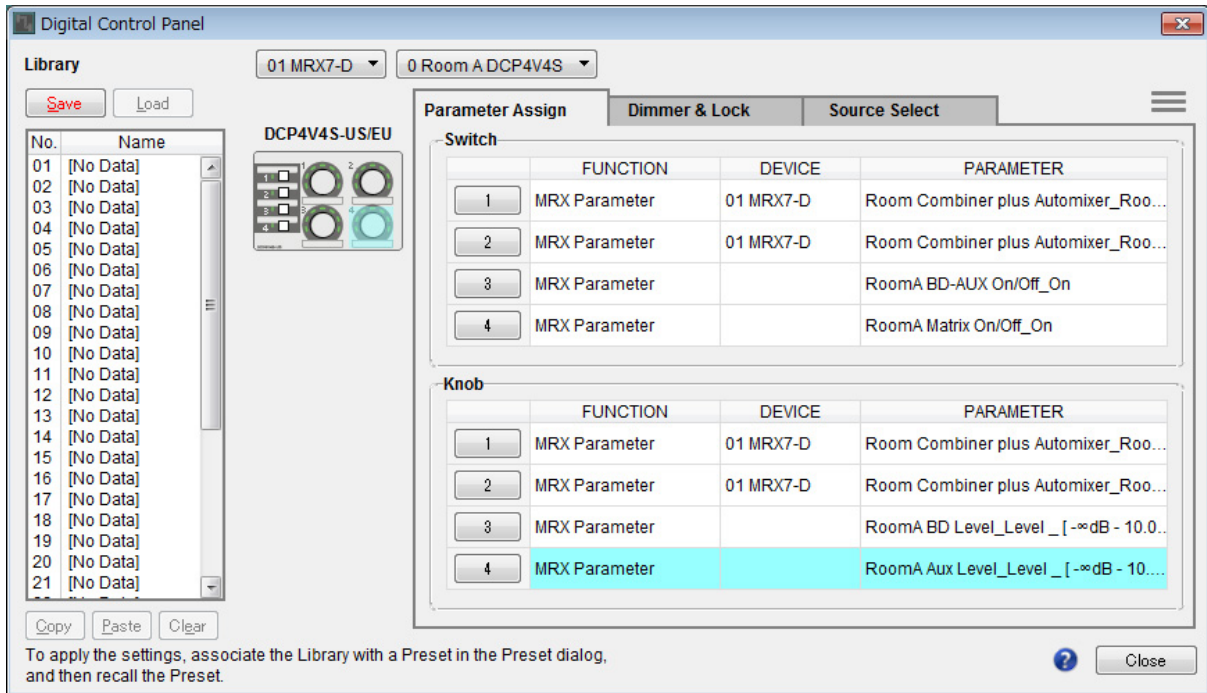

10. Click No. 01 in the “Library”, and then click the [Save] button.

The “Save Library” dialog box will appear.

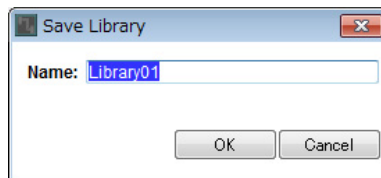

11. Input [Room Split] and click the [OK] button.

The data will be registered in No. 01 of the “Library.”

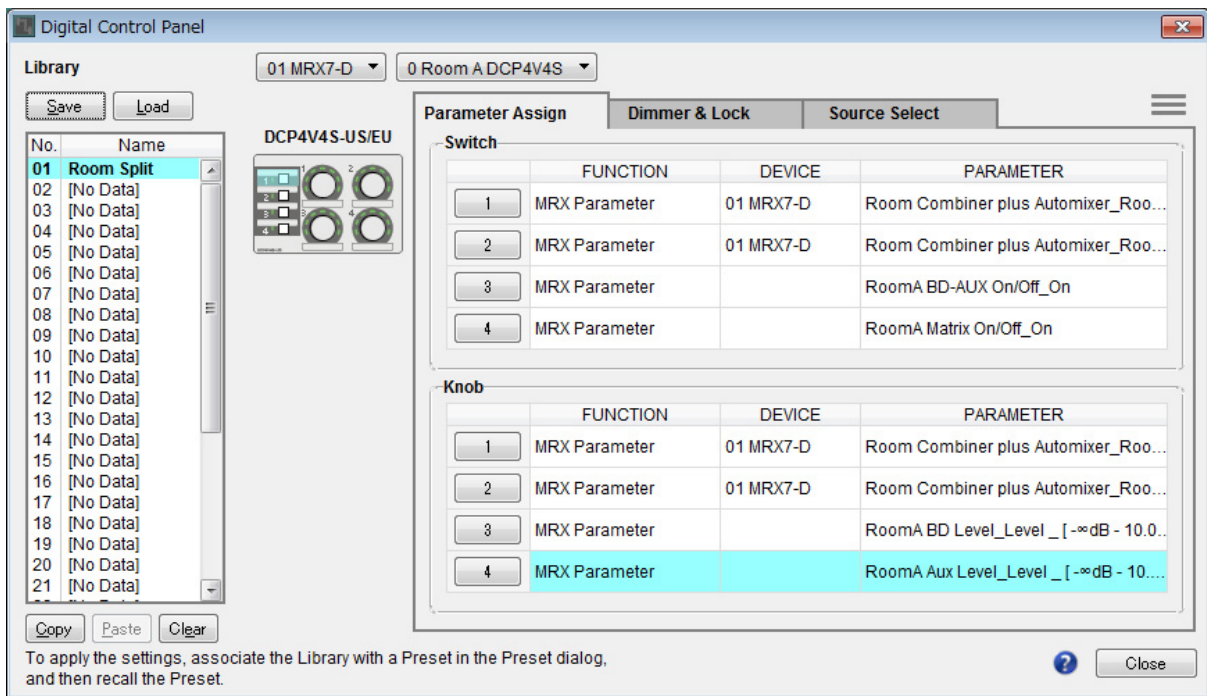

12. Since “Room Split” and “Room Combine” are the same for the DCP in Room A, click No. 02 in the “Library”, and then click the [Save] button.

The “Save Library” dialog box will appear.

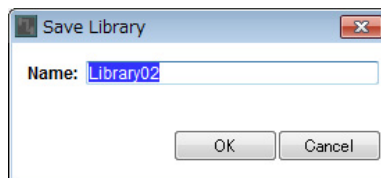

13. Input [Room Combine] and click the [OK] button.

The data will be registered in No. 02 of the “Library.”

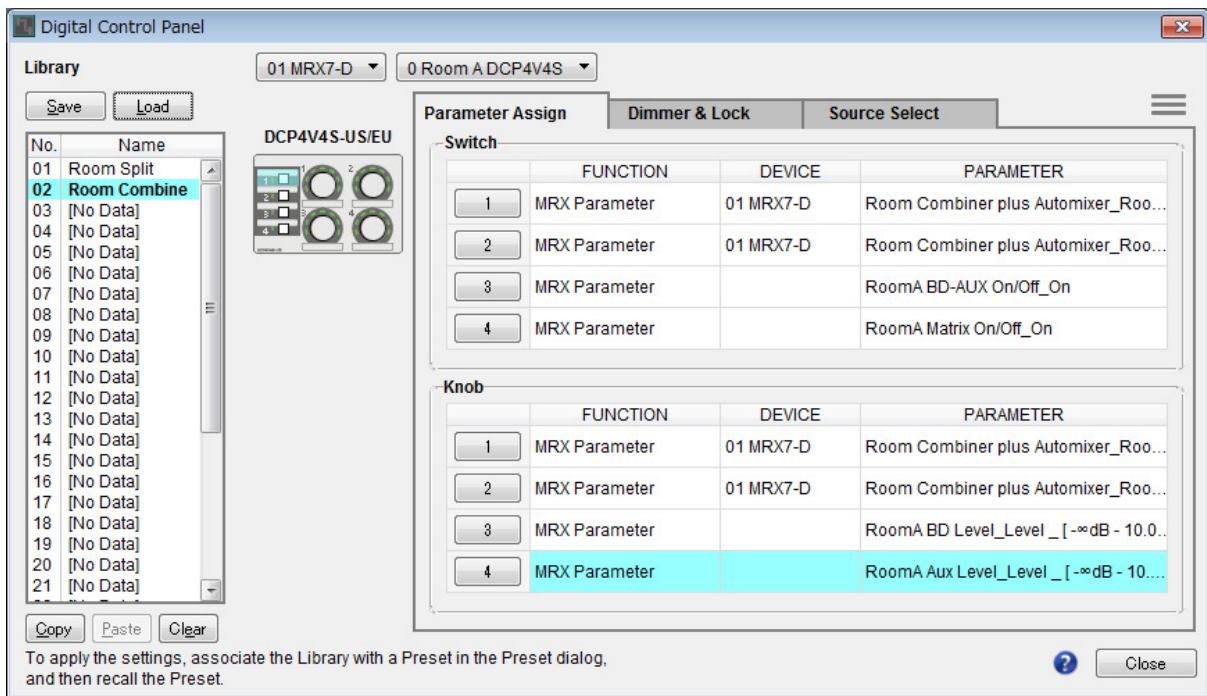

14. Select [1 Room A DCP4S] using the DCP selection list box.

The screen will change to the Room A DCP4S settings screen for ID=1.

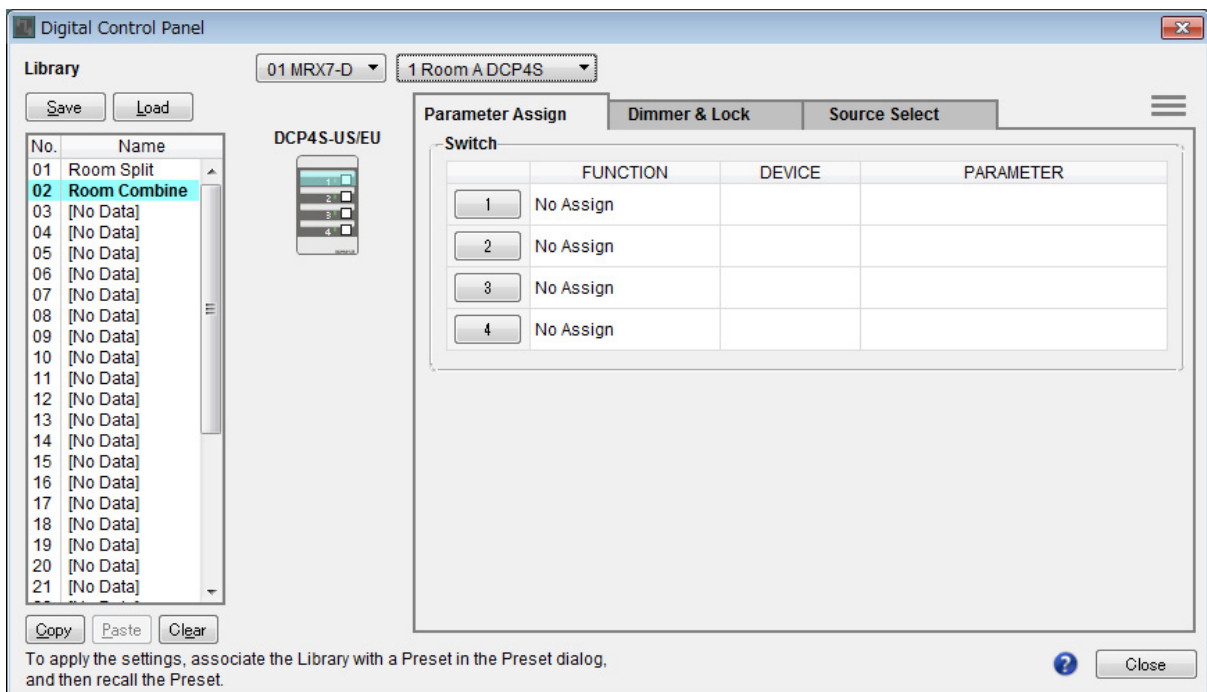

15. Click the “Switch” [1] button on the “Digital Control Panel” dialog box.

The “Settings” dialog box will appear.

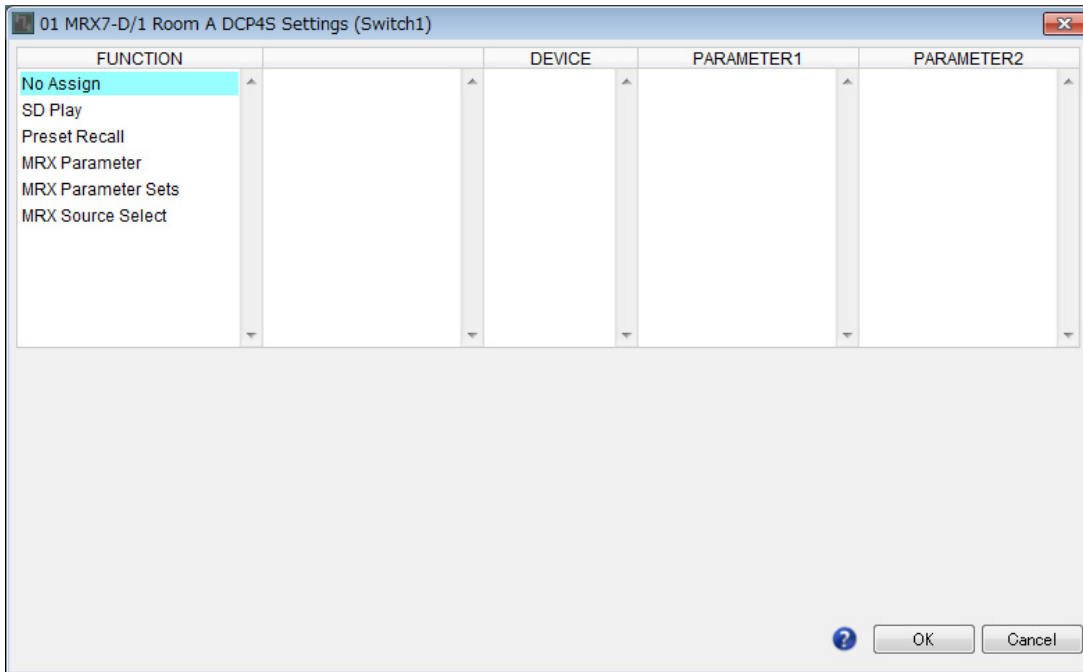

16. Click [Preset Recall] under “FUNCTION.”

The screen changes to a screen where you can register the preset to recall.

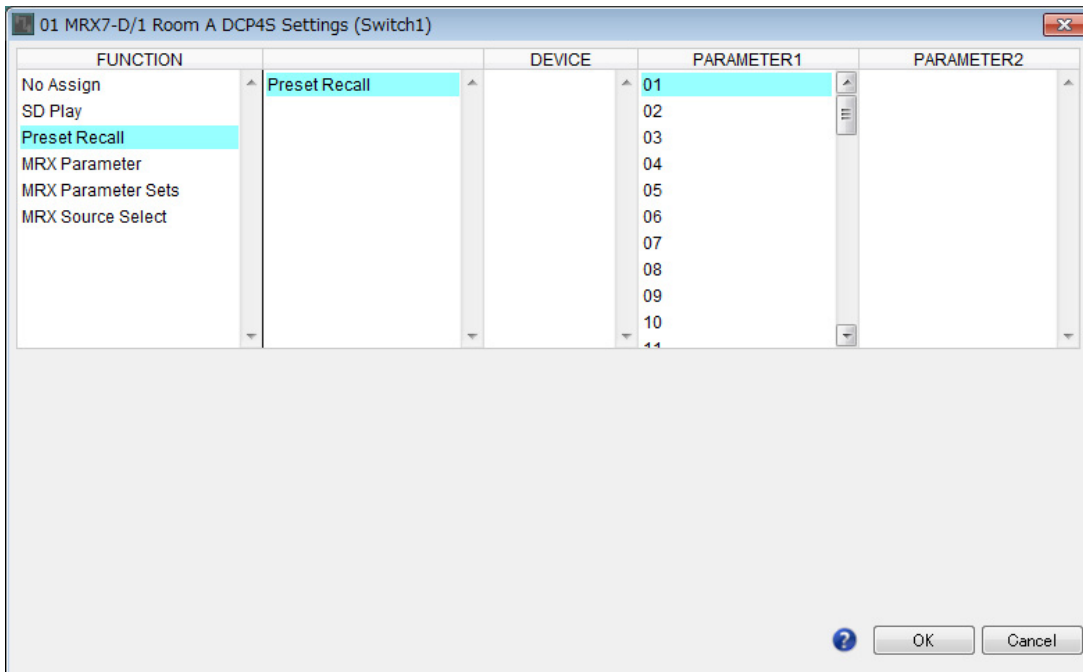

17. Click [01] in “PARAMETER 1”, and then click the [OK] button.

The “Digital Control Panel” dialog box will be displayed, with the 01 in the presets registered.

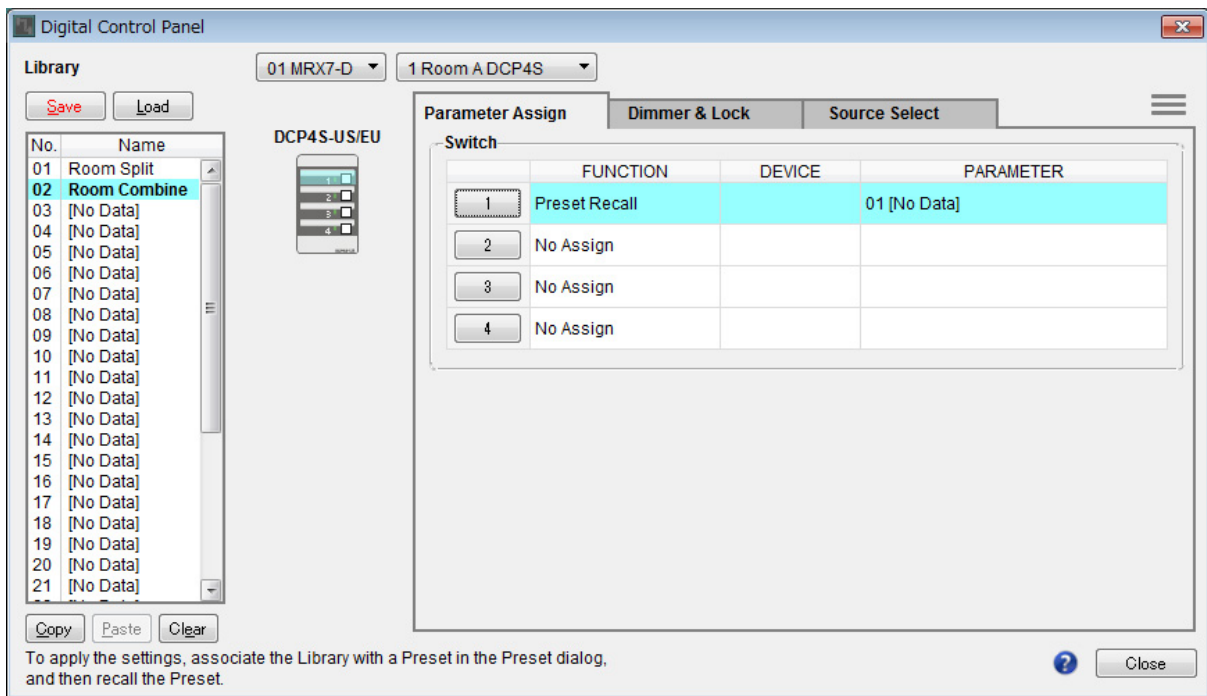

18. Register the presets and parameters to the other switches in the same way.

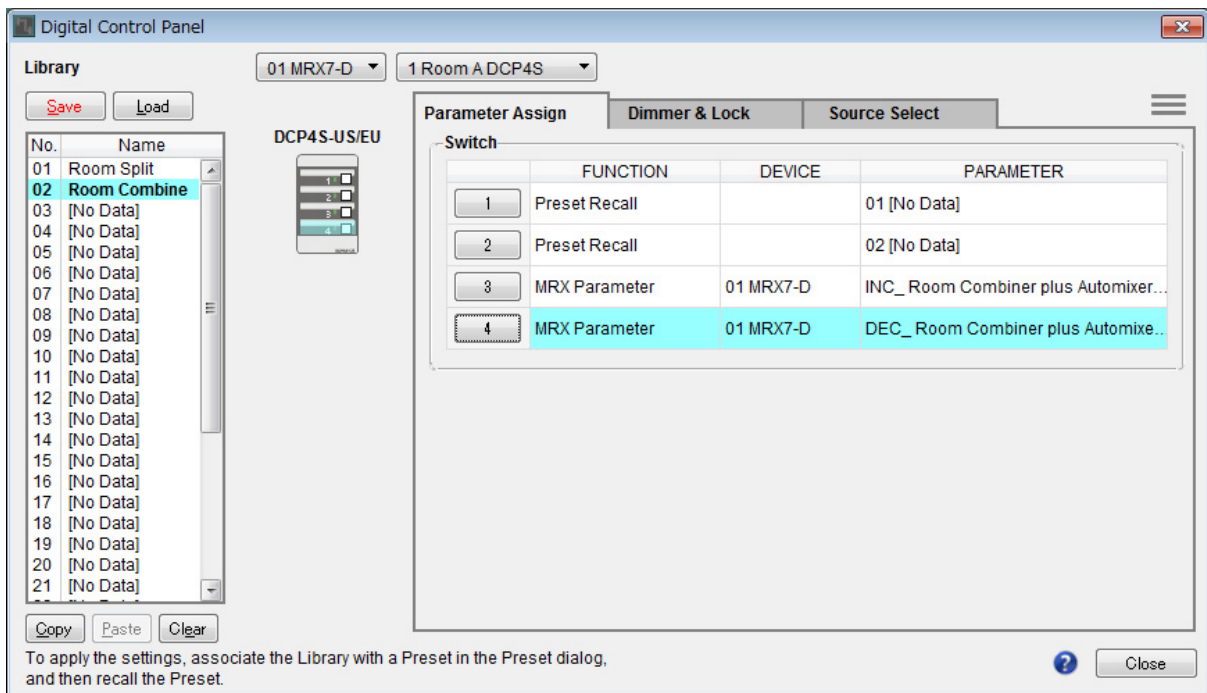

19. Select both No. 01 and No. 02 in the “Library”, and then click the [Save] button.

The settings for the DCP4S in Room A are overwritten.

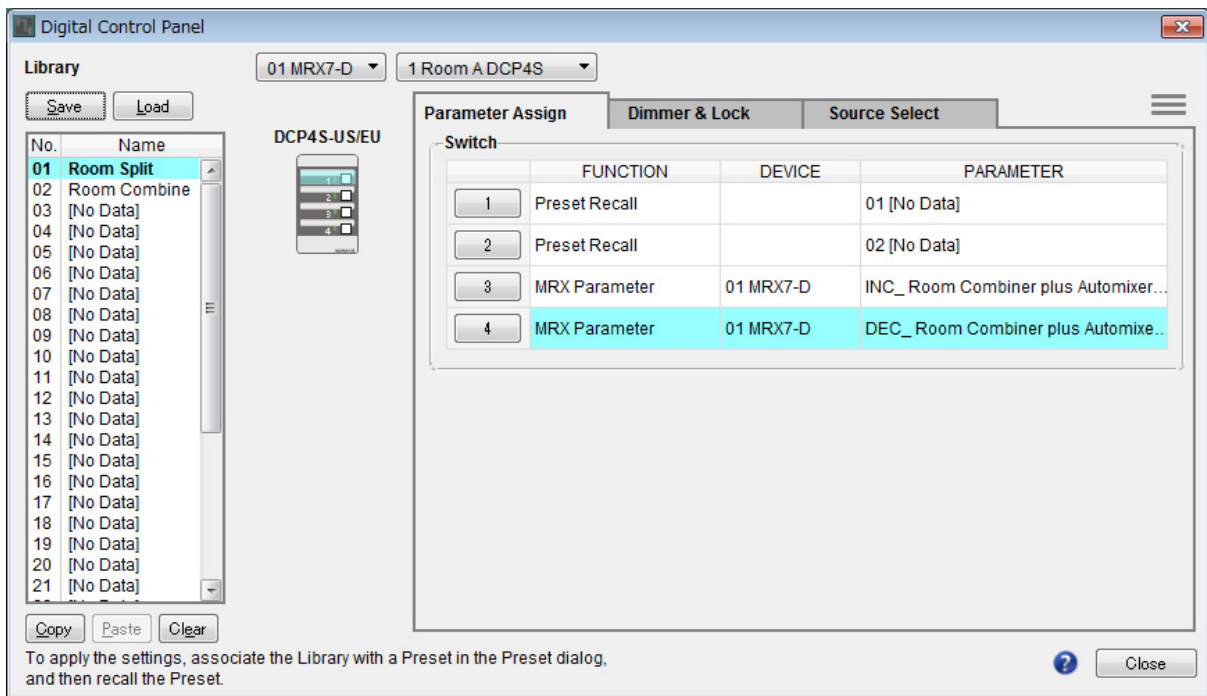

20. Set the DCP for Room B in the same way.

The “Room Combine” settings for Room B are the same as the “Room Combine” settings for Room A. Click the menu button for the DCP of Room A (☰) and select [Copy], switch to the DCP of Room B, and then select [Paste] from the menu button. Afterwards, if you save this by overwriting as “Room Combine”, the work will be easier.

Storing presets

Set the preset that will be recalled from the DCP4S.

- 1. Click the [Preset] tool button ().
The [Preset] dialog box will appear.

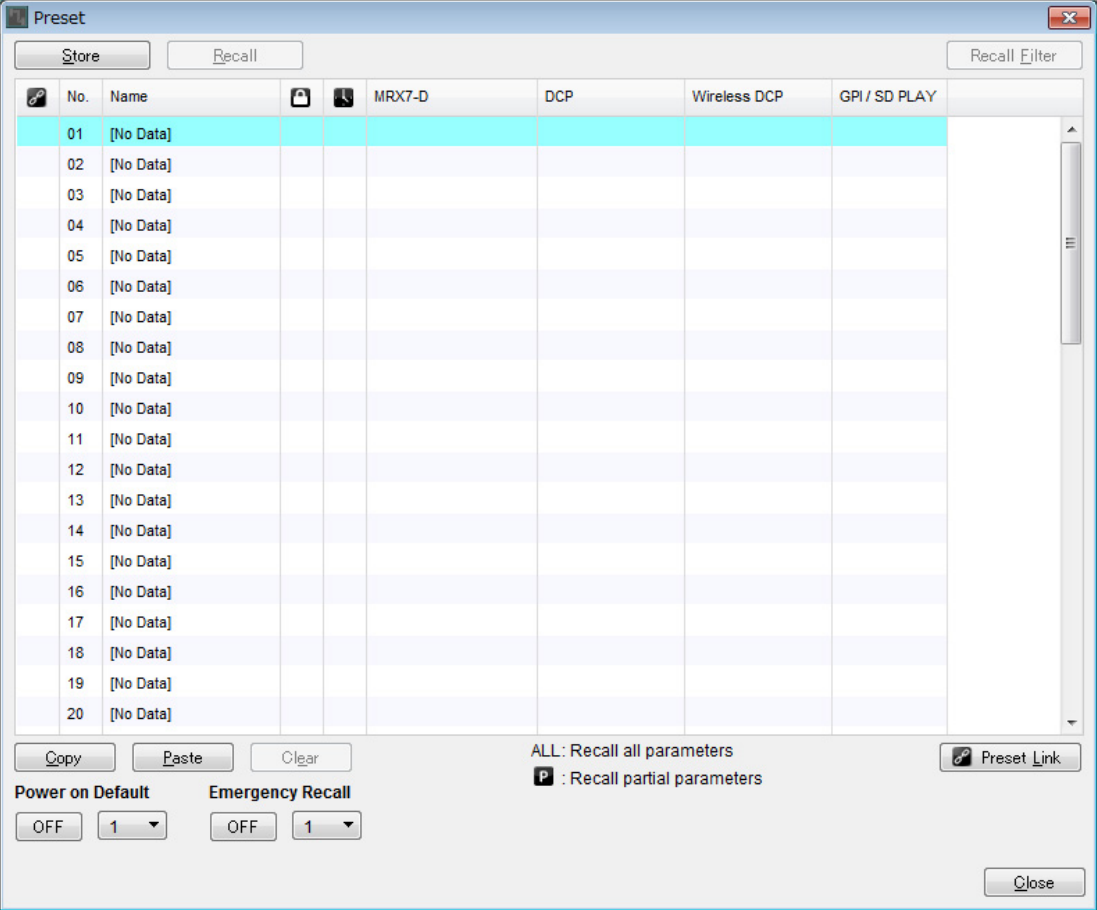

- 2. Click No. 01 and then click the [Store] button.
The “Store Preset” dialog box will appear.

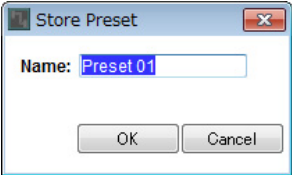

3. Input [Split] and click the [OK] button.

The current state will be registered as a preset named “Split.”

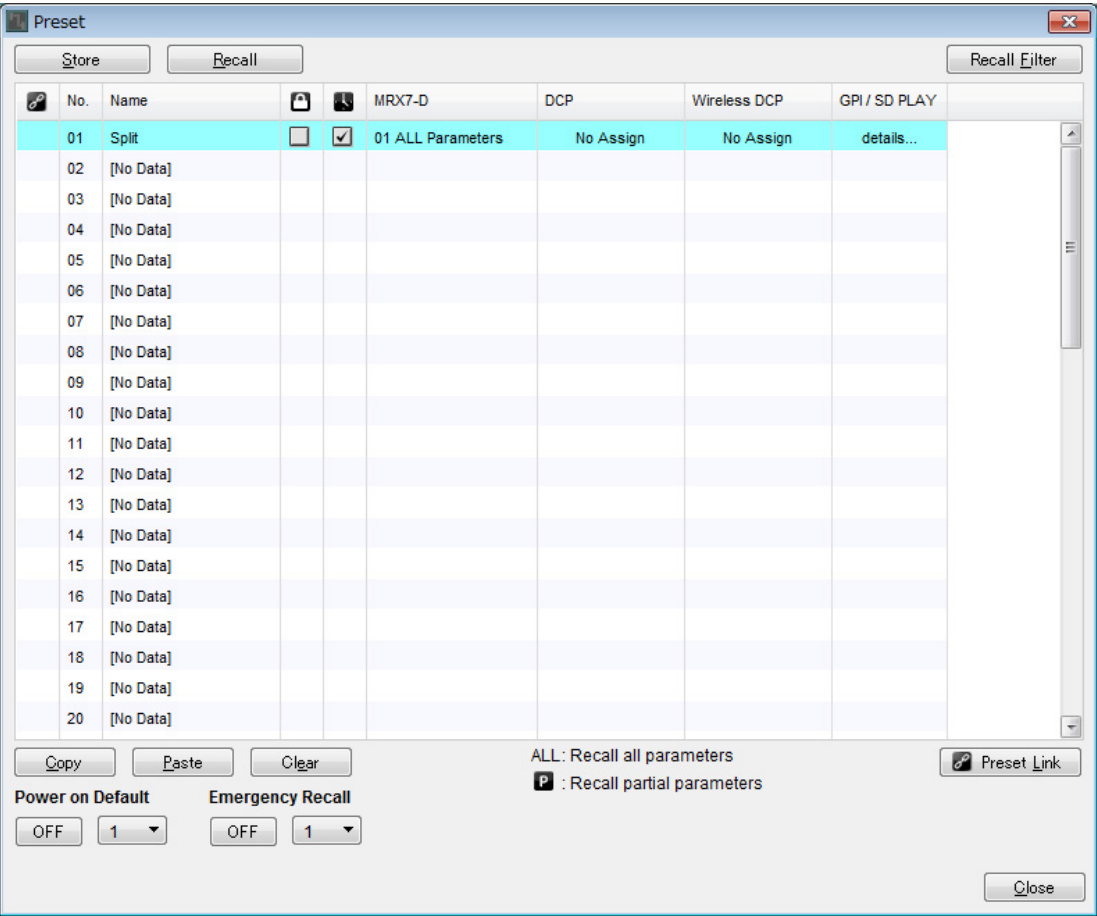

4. Click on the [MRX7-D] field in No. 01.

The “Snapshot” dialog box will appear.

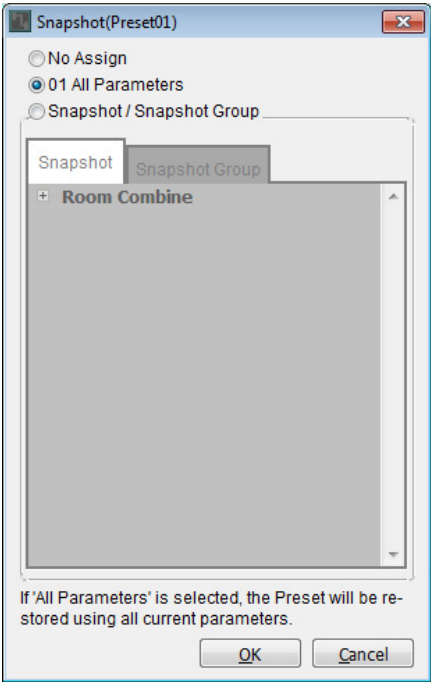

5. Select [Snapshot/Snapshot Group].

The screen changes to the snapshot registration screen.

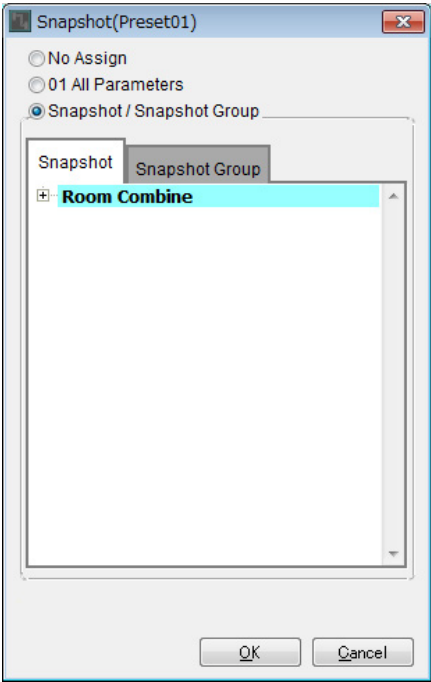

6. Click [+] to expand the snapshot list.

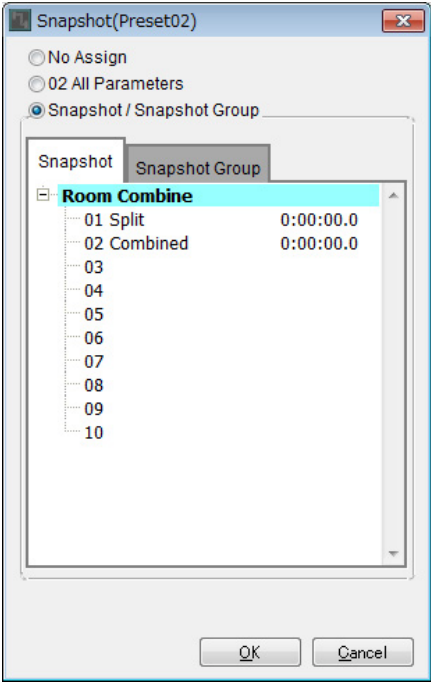

7. Click [01 Split] and then click the [OK] button.

When the preset is recalled, the snapshots will also be recalled.

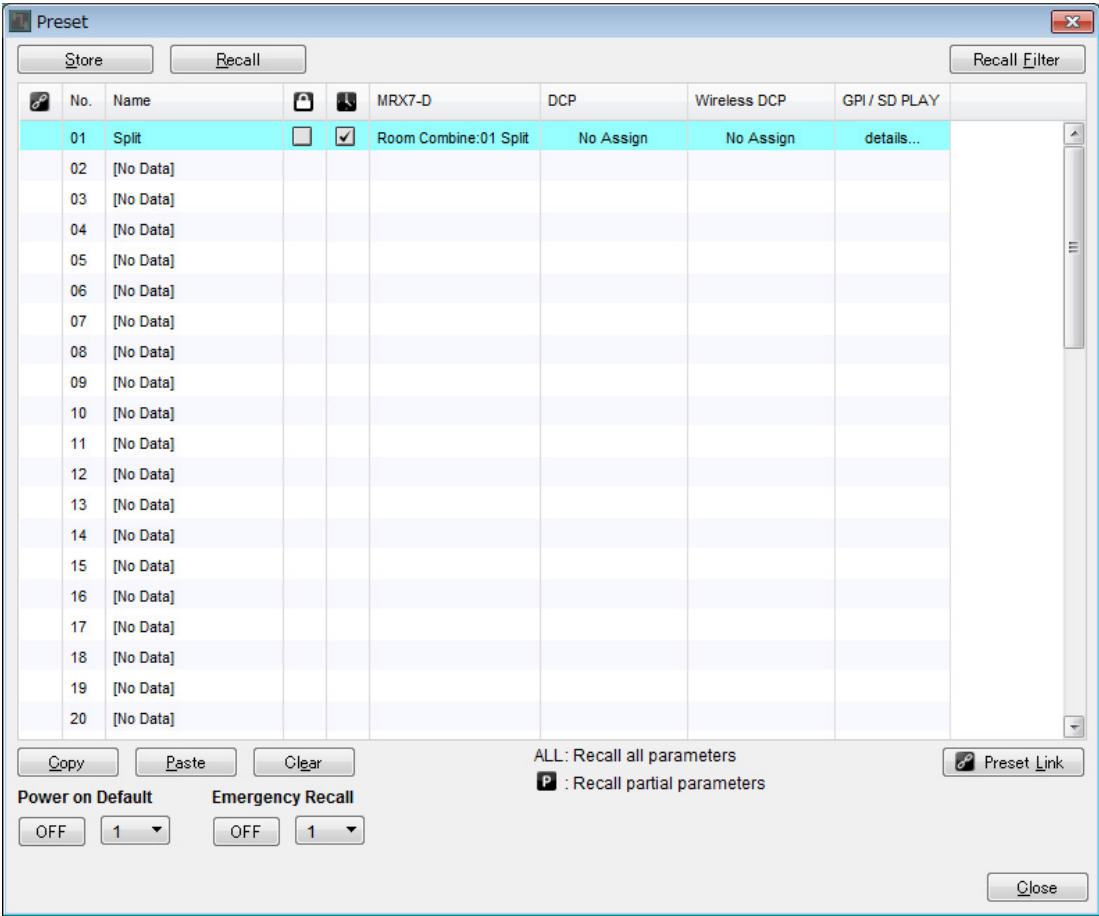

8. Double-click the [DCP] field in No. 01.

The “Settings” dialog box will appear.

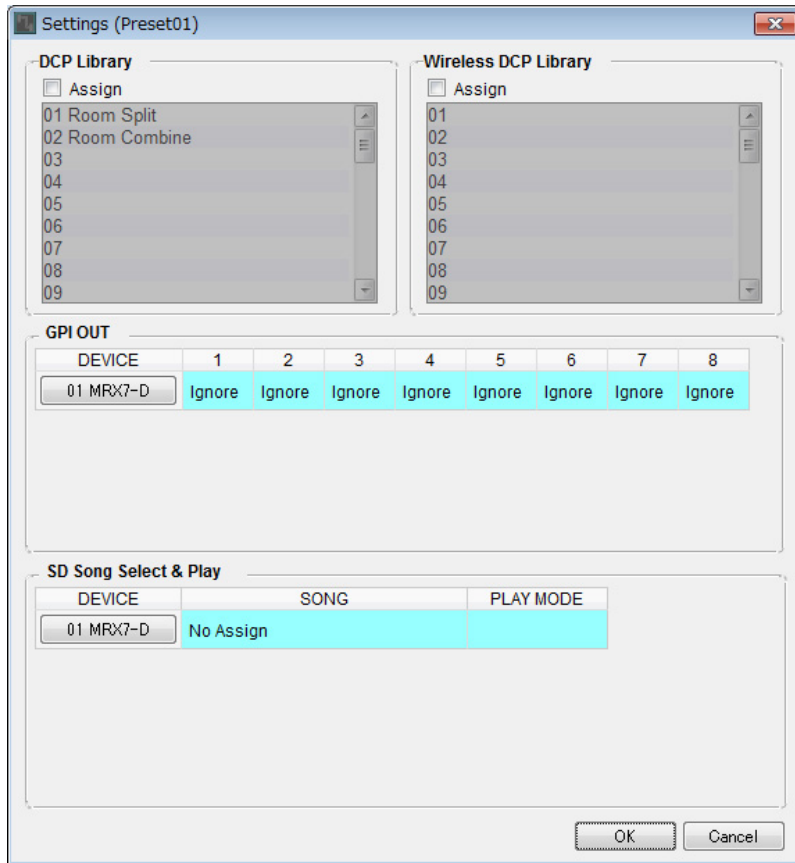

9. Select the [Assign] check box in “DCP Library.”

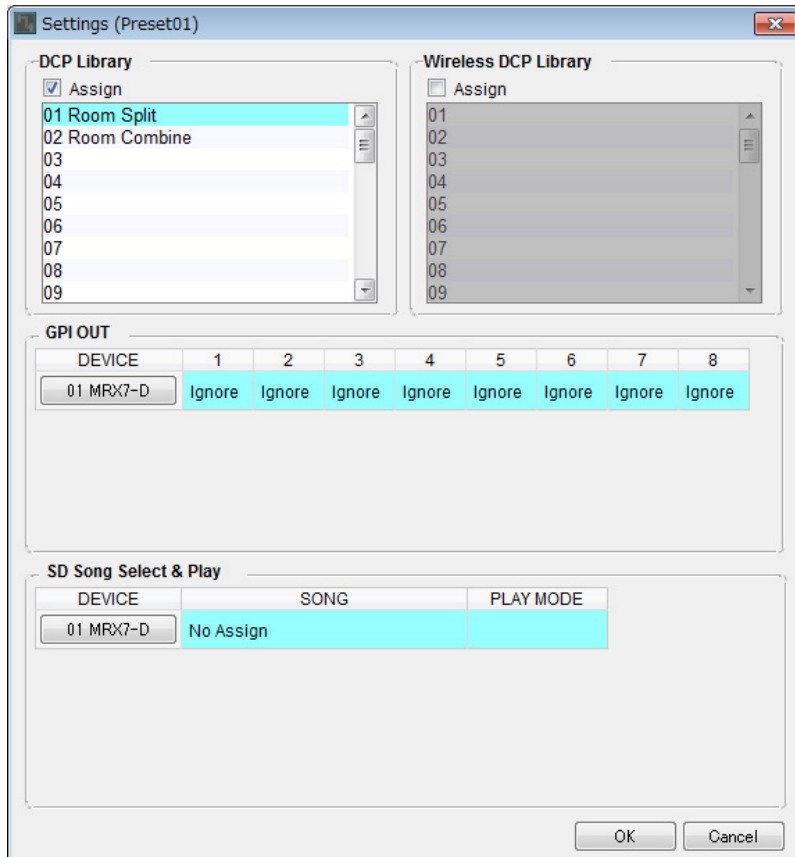

10. Click [01 Room Split] and then click the [OK] button.

When the preset is recalled, the library will also be loaded.

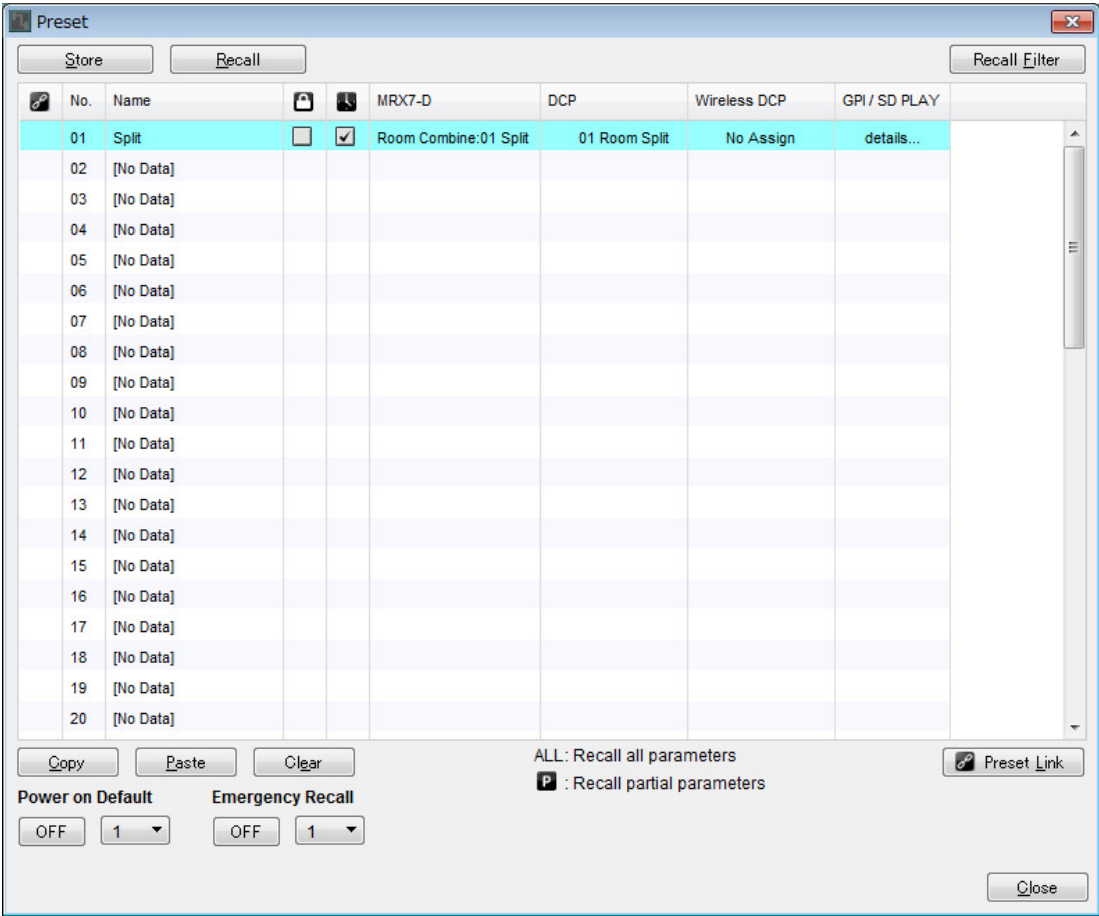

11. Click No. 02 and then click the [Store] button.

The “Store Preset” dialog box will appear.

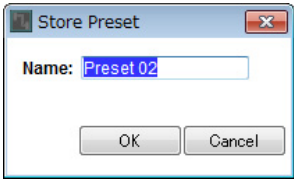

12. Input [Combine] and click the [OK] button.

The current state will be registered as a preset named "Combine."

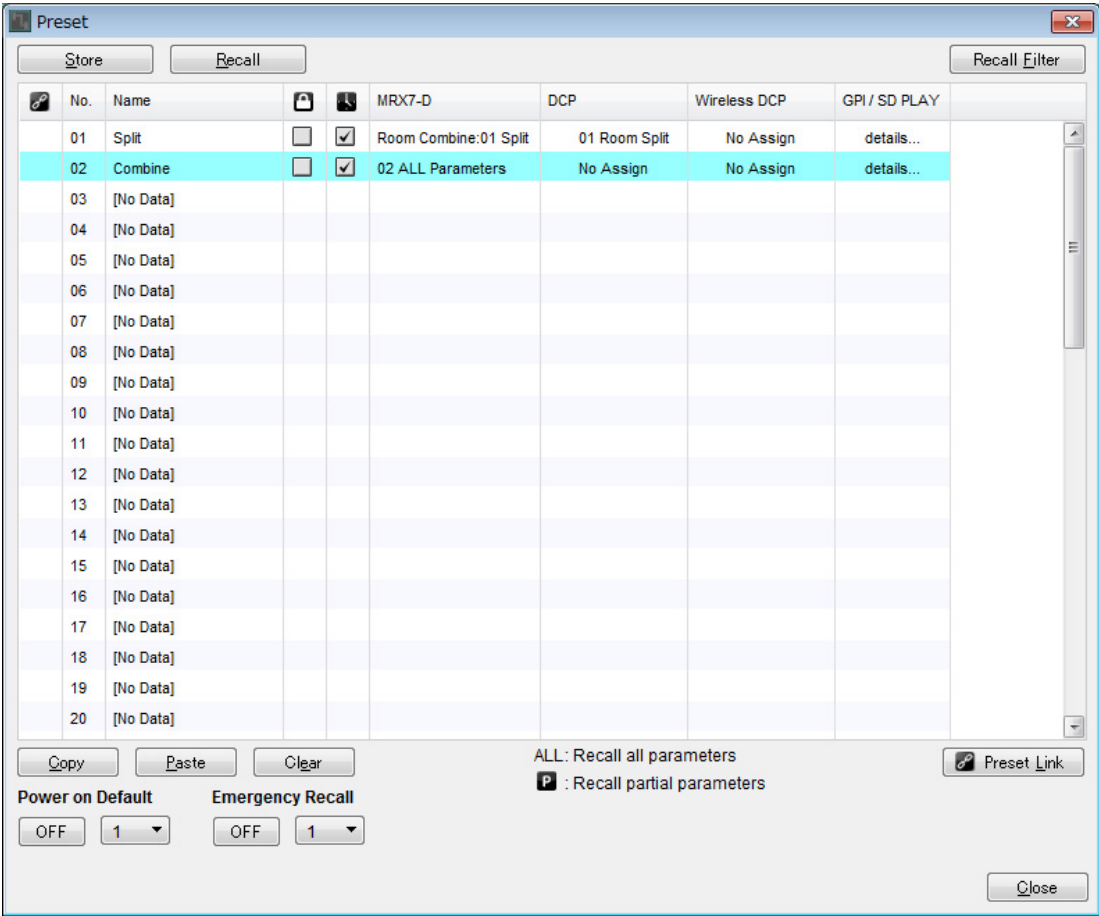

13. Set the “Combine” preset in the same way.

For the MRX7-D, set the [02 Combined] snapshot; and for the DCP, set the [02 Room Combine] library.

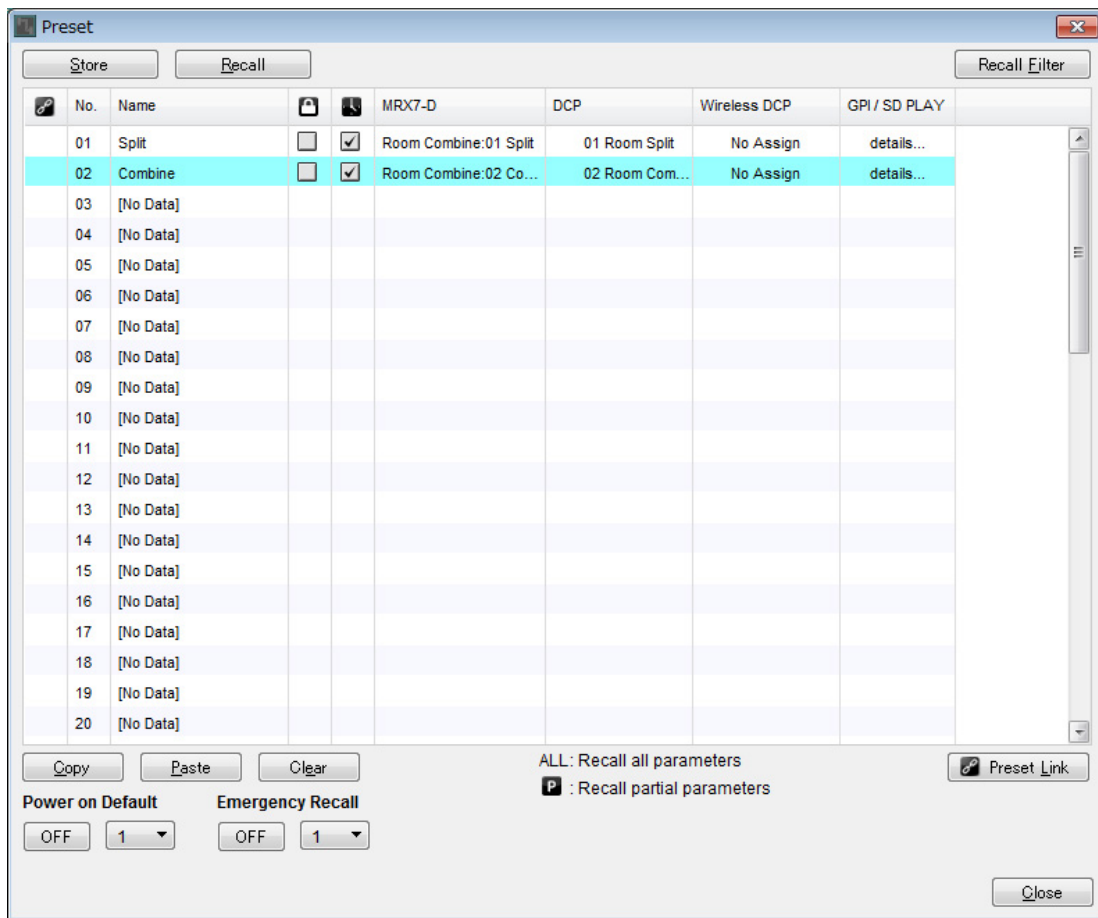

14. Click the [Close] button.

The “Preset” dialog box is closed.

This completes settings in the offline state. Save the settings once again.

Connecting the equipment

After you've rack-mounted the MRX and your other equipment, connect the MRX and the other equipment as shown below. If you've copied audio sources to an SD memory card, insert the card into the MRX now.

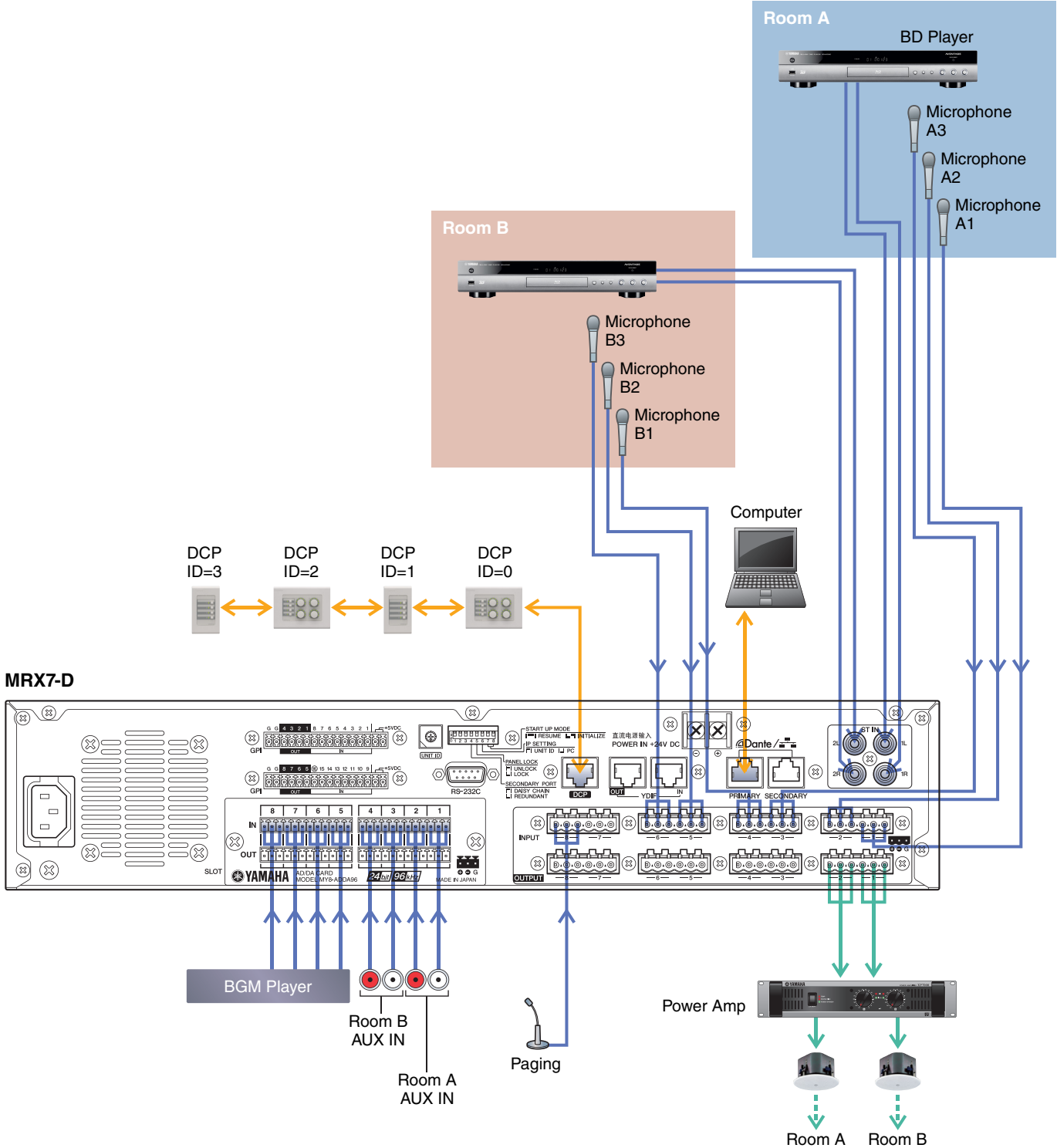

Powering-on the MRX

Turn on the power of the MRX.

Turn off the amplifier before you power-off the MRX.

Powering-on the amp

Turn on the power of the amplifier.

To prevent unwanted sound from being output, we recommend that you turn down the attenuator settings of all channels on the amp itself before you turn it on.

Specifying the computer's TCP/IP address

To allow the MRX and the computer to communicate, specify the computer's TCP/IP as follows.

1. Select [Network Setup] in the [System] menu of the MTX-MRX Editor.

The "Network Setup" dialog box will appear.

2. Click [Open Network Connection].

"Network Connections" will appear.

3. Right-click the adapter to which the MRX is connected, and choose [Properties].

The "Local Area Connection Properties" dialog box will appear.

4. Choose [Internet Protocol Version 4 (TCP/IPv4)], and then click [Properties].

The "Internet Protocol Version 4 (TCP/IPv4) Properties" dialog box will appear.

5. Click [Use the following IP address (S)].

6. In the [IP address] box, enter "192.168.0.253"; in the [Subnet mask] box, enter "255.255.255.0."

NOTE

The IP address of the MRX7-D is set to "192.168.0.1."

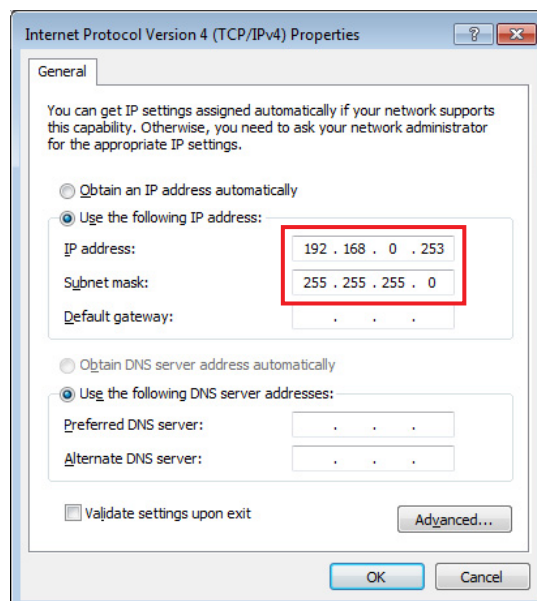

7. Click [OK].

NOTE

In some cases, Windows firewall may block MTX-MRX Editor when you make this setting. Select the [Private Network] check box, and click [Allow Access].

Taking MTX-MRX Editor online

In the upper right of MTX-MRX Editor, click the [Online] button. When the unit has successfully come online, the indicator 1 will light blue.

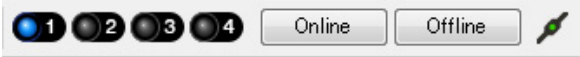

When the “Synchronization” dialog box appears, select “To Device,” and click the [OK] button. When the indication in the dialog box has switched, select the system that you want to place online, and click the [Online] button. The project created in MTX-MRX Editor will be sent to the MRX.

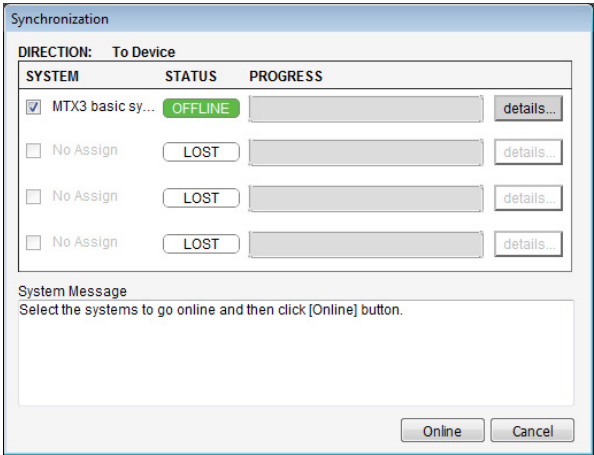
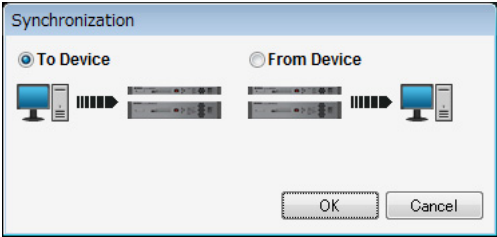

Verifying that the settings were applied

The main items to verify are listed below. For details on each parameter setting, refer to “MTX-MRX Editor User Guide” and “MRX Designer User Guide.”

1. Push switch 1 of the DCP4S to recall the “Split” preset.
2. Connect an audio signal such as BGM, a Blu-Ray disc player, or AUX IN to the inputs of the MRX7-D, and adjust the input levels.

Individually adjust the BGM input levels using “Fader(3).” The overall BGM sound can be adjusted using knob 2 on the DCP4V4S. Individually adjust the input levels of the Blu-Ray disc player and AUX IN using “Fader(2)” and “Fader(5).”

NOTE

When adjusting the Blu-Ray disc player and AUX IN, make sure that the Matrix Mixer is on. Also, since the input signal that will be accepted is based on whether the fader is on/off, use switch 3 on the DCP4V4S to switch between the two when making adjustments.

3. Individually adjust the output levels using “Fader(6).”
4. Adjust the input level of the mic using the “ANALOG IN” editor.

Turn the [+48V] button on as necessary.

NOTICE

Be sure to leave this button off if you do not need phantom power.

Follow the important precautions below, in order to prevent noise and possible damage to external devices as well as the unit when you operate this switch.

- Be sure to leave this button off when you connect a device that does not support phantom power to [INPUT] connector.
- Do not connect/disconnect a cable to/from [INPUT] connector while this button is on.
- Down the output level to the minimum before operating this button.

NOTE

There is no master switch. To avoid malfunctions, be sure to set this appropriately for the equipment that is connected.

5. Adjust the other inputs and outputs.
6. Press switch 2 of the DCP4S to recall the “Combine” preset.

Check the input and output levels.

When you need to make settings for “Split” and “Combine” but cannot operate the parameters from the DCP, register the parameters in the “Room Combine” parameter set, storing the state before changing parameters as “Split”, and the state after changing parameters as “Combine.”

7. Confirm the DCP settings.

Check whether the DCP is operating according to the settings.

When you have finished making all settings, save the project and switch MTX-MRX Editor offline.

This completes the settings for example 1.

Example 2) Remote conferencing system that also uses Speech Privacy

■ Glossary

Here we'll explain the terminology used for the remote conferencing system.

Gossary	Description
Local	Your own meeting room within the remote conferencing system. Also called "near-end."
Remote	The other party's meeting room within the remote conferencing system. Also called "far-end."
From Far-end	The input signal from the remote location (the other party.)
Far-end Voice	The signal from the remote location reproduced via your local speakers.
Near-end Mic.	The input signal from the microphone(s) of the remote location.
Near-end Voice	The signal from the local microphone(s) reproduced via the local speakers.
To Far-end	The signal of the local microphone(s), processed by echo cancellation and sent to the remote location.
CODEC	A device for transmitting and receiving data via a digital communication network.

Using the Device Configuration Wizard to create your device setup

Before setting the internal configuration on the MRX, use the wizard on the MTX-MRX Editor to create a configuration for the device.

After you've made basic settings, you'll be able to print information about system cabling and ID numbers. Use the following procedure to make basic settings.

1. Type a name for the MTX/MRX System you'll be constructing, and click [Next>].

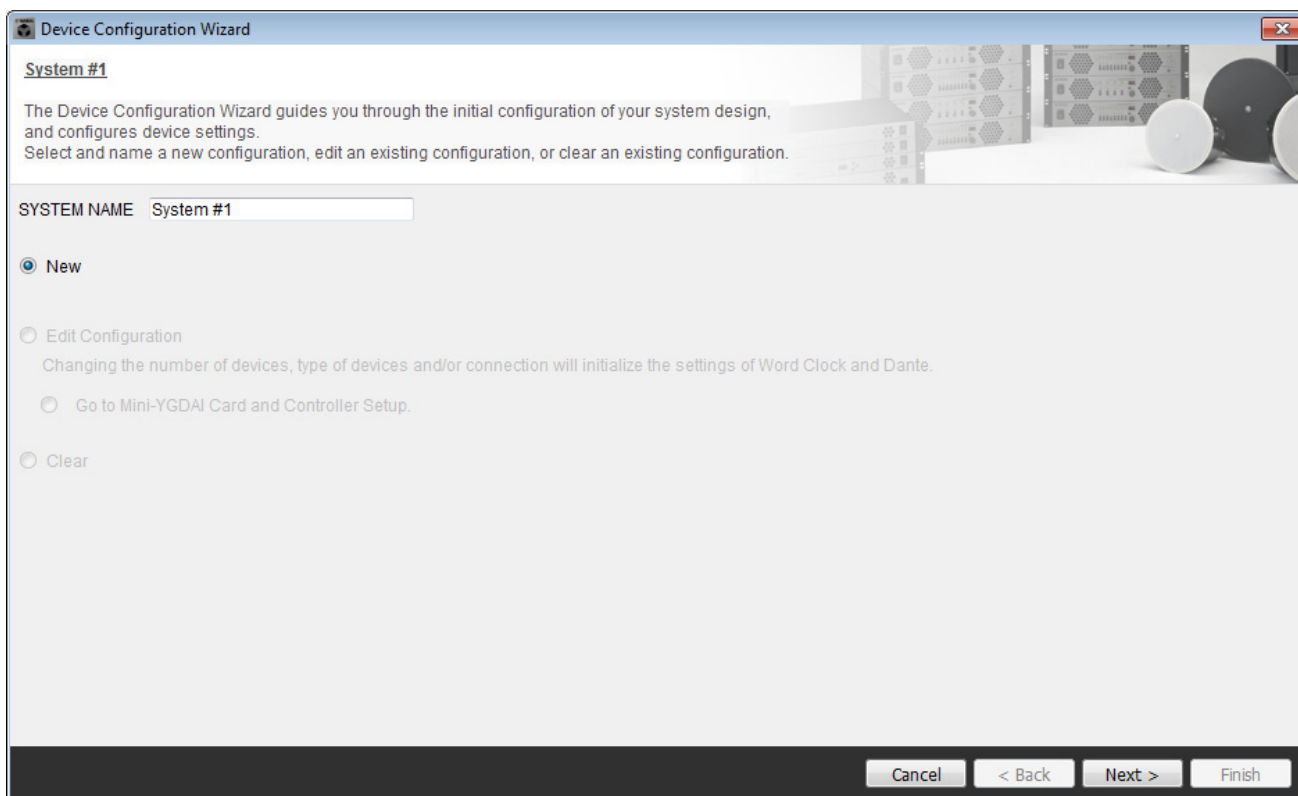

2. Specify the number of units that will be connected in your MTX/MRX System, and click [Next>].

Specify “1” as the number of MRX7-D units in “YDIF Connected,” and specify “1” as the number of XMV4280 units to be connected.

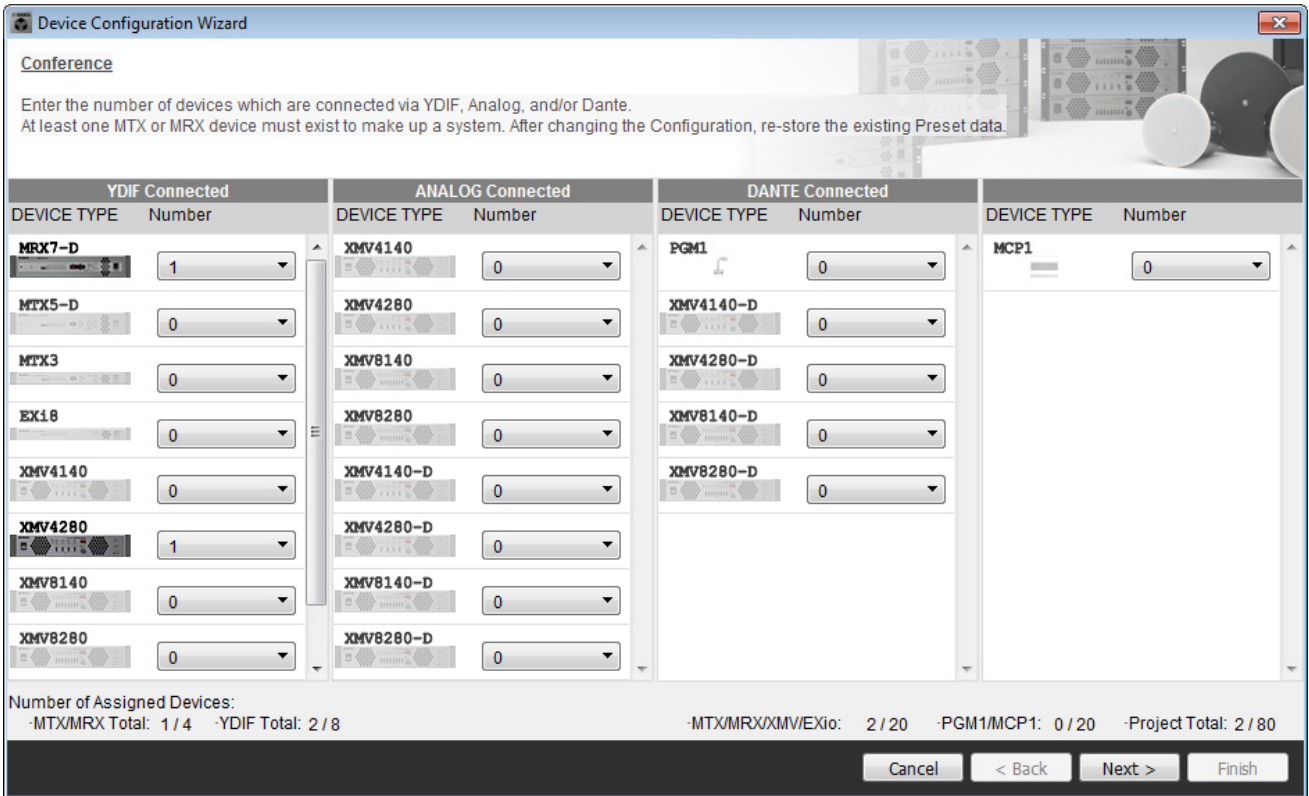

3. Specify the UNIT ID of each device, and click [Next>].

Unless you have specific reasons for doing so, use the UNIT ID that is assigned. In this example, set the XMV’s UNIT ID to 1A so that we can explain how to change the UNIT ID.

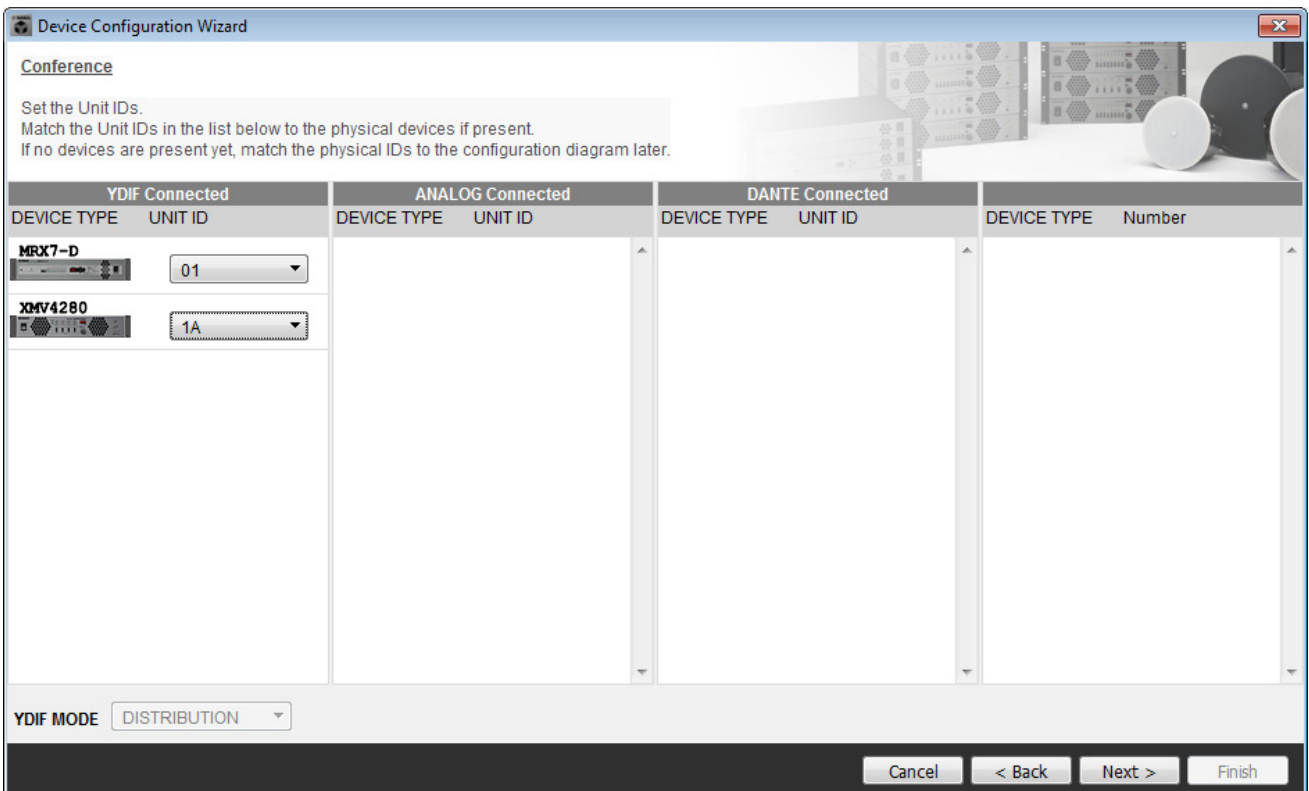

4. Set the [UNIT ID] rotary switch and DIP switch of the MRX and XMV.

You will set the computer's IP address after completing the wizard, in "Specifying the computer's TCP/IP address." If the MRX and XMV are not nearby, you can set them during the step "Connecting the equipment."

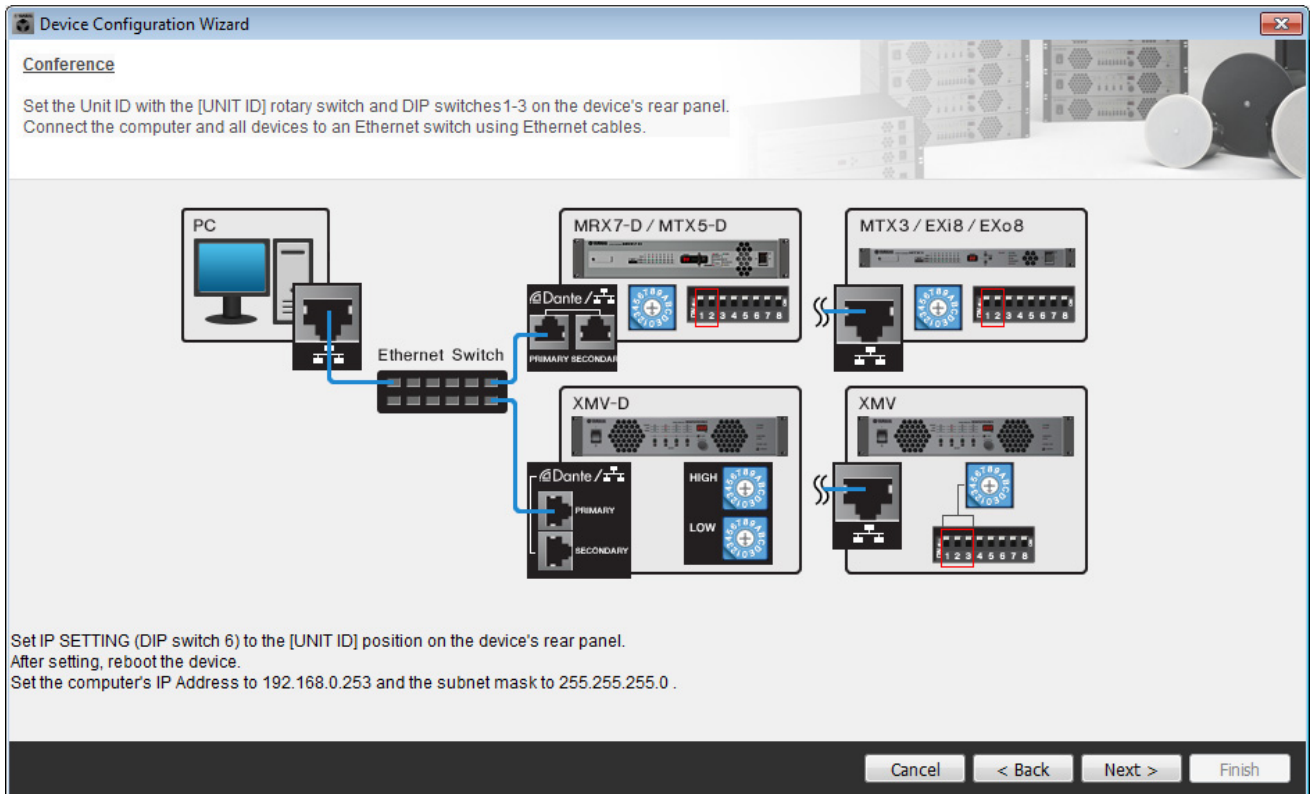

Make the following settings.

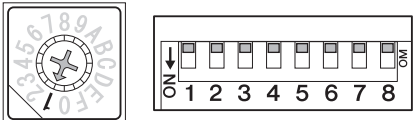
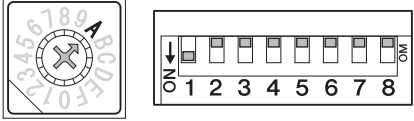
<p>MRX7-D</p> 	<p>UNIT ID = 01 [UNIT ID] rotary switch = 1 DIP switches are all OFF (upward)</p>
<p>XMV</p> 	<p>UNIT ID = 1A [UNIT ID] rotary switch = A DIP switch 1 is ON (downward), others are OFF (upward)</p>

5. When you have finished setting the [UNIT ID] rotary switch and DIP switch of the MRX and the XMV, click [Next>].

6. Verify that the MRX and XMV are shown in the screen, and click [Next>].

Since there is only one MRX unit and one XMV unit, there's no need to change the order.

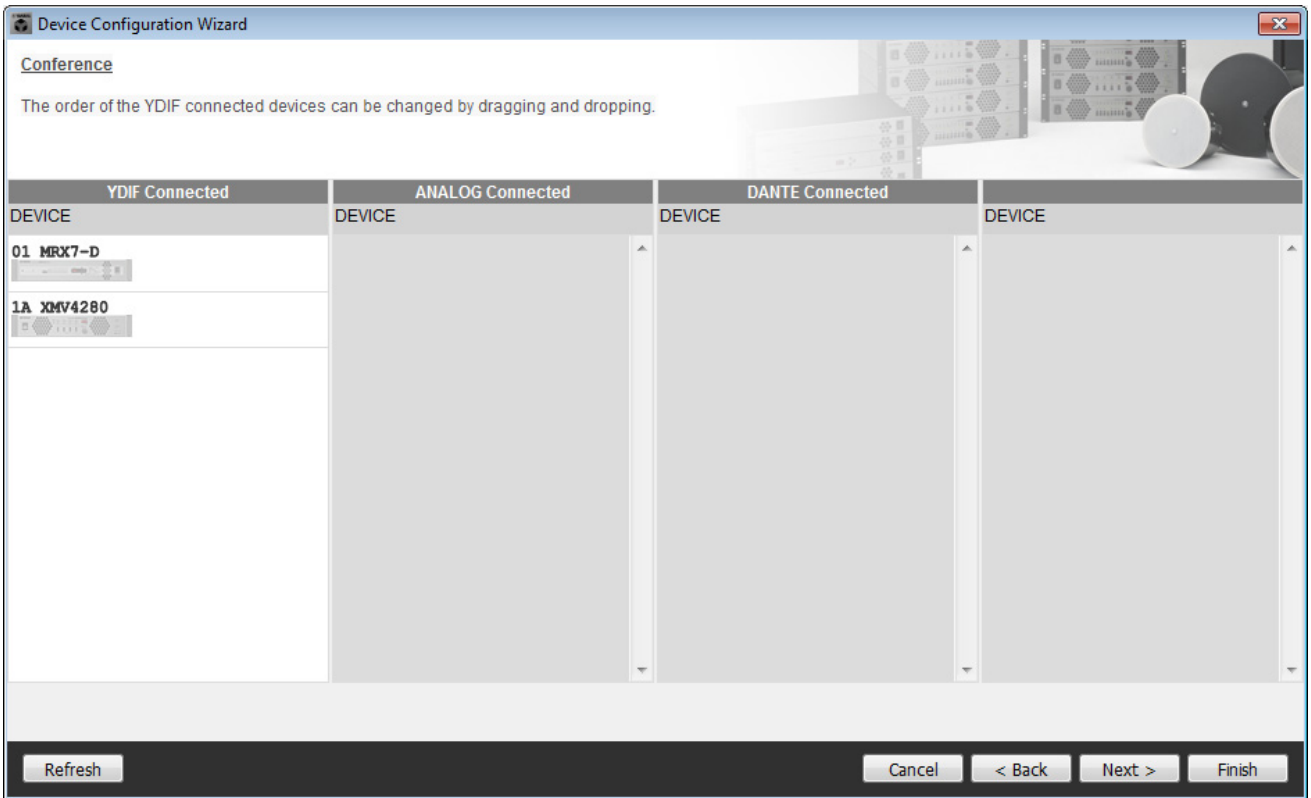

7. Click [Next>].

On the MRX Designer of the MRX, select the Mini-YGDAI card.

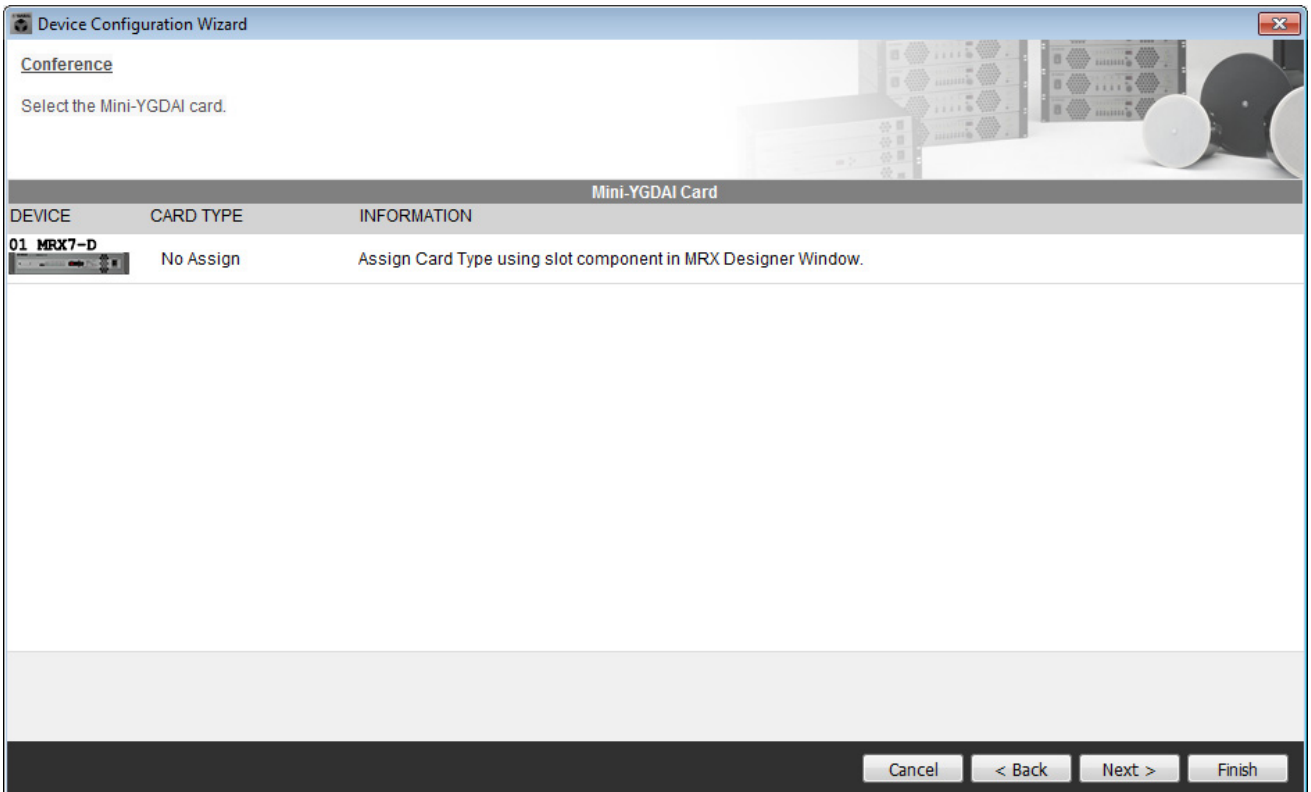

8. Choose the model of DCP that is connected to the MRX, enter a device name, and click [Finish].

For this example, we will use ProVisionaire Touch, and we will not make any settings on the DCP.

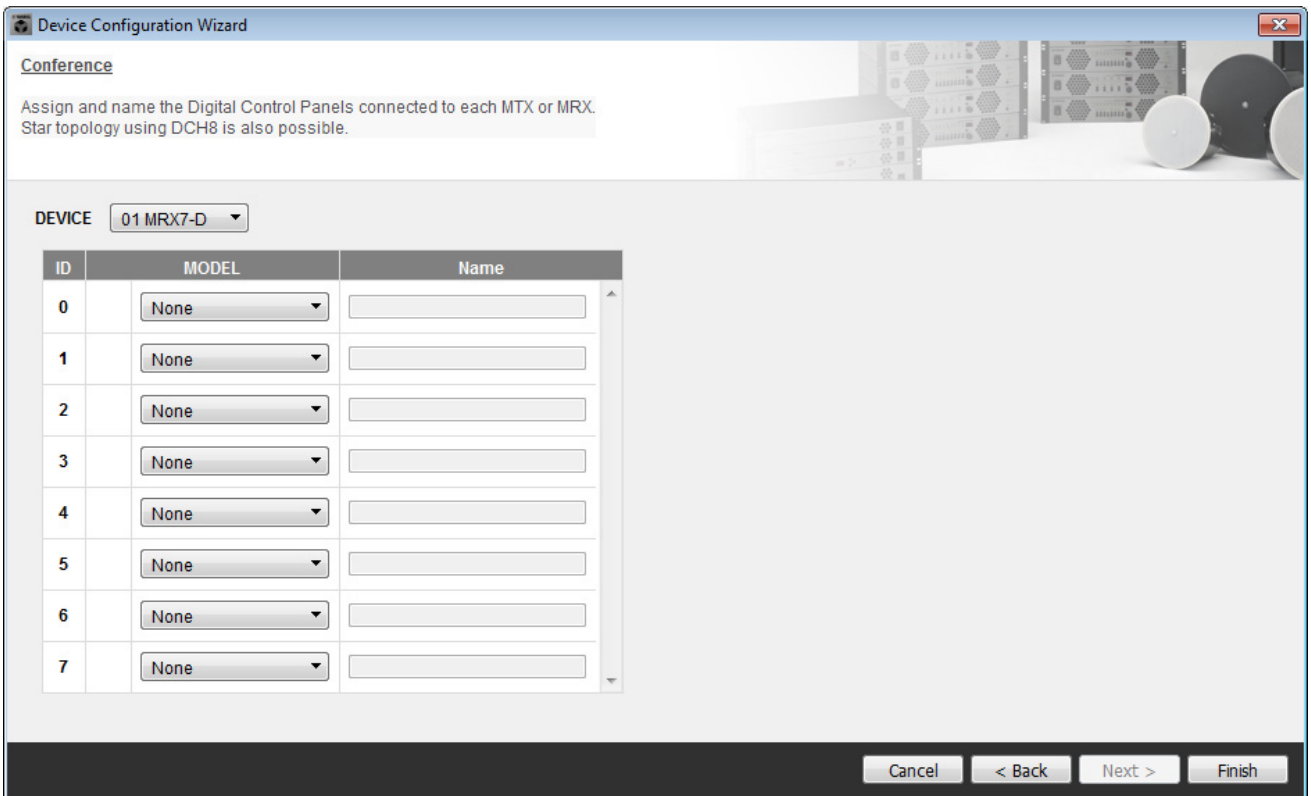

- When you see the dialog box “Display the configuration diagram? The diagram can also be printed.” click [Yes].

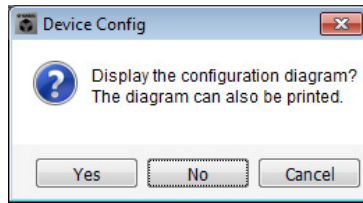

A cabling diagram will appear. If you want, click [Print] to print the diagram. To close the screen, click [Close].

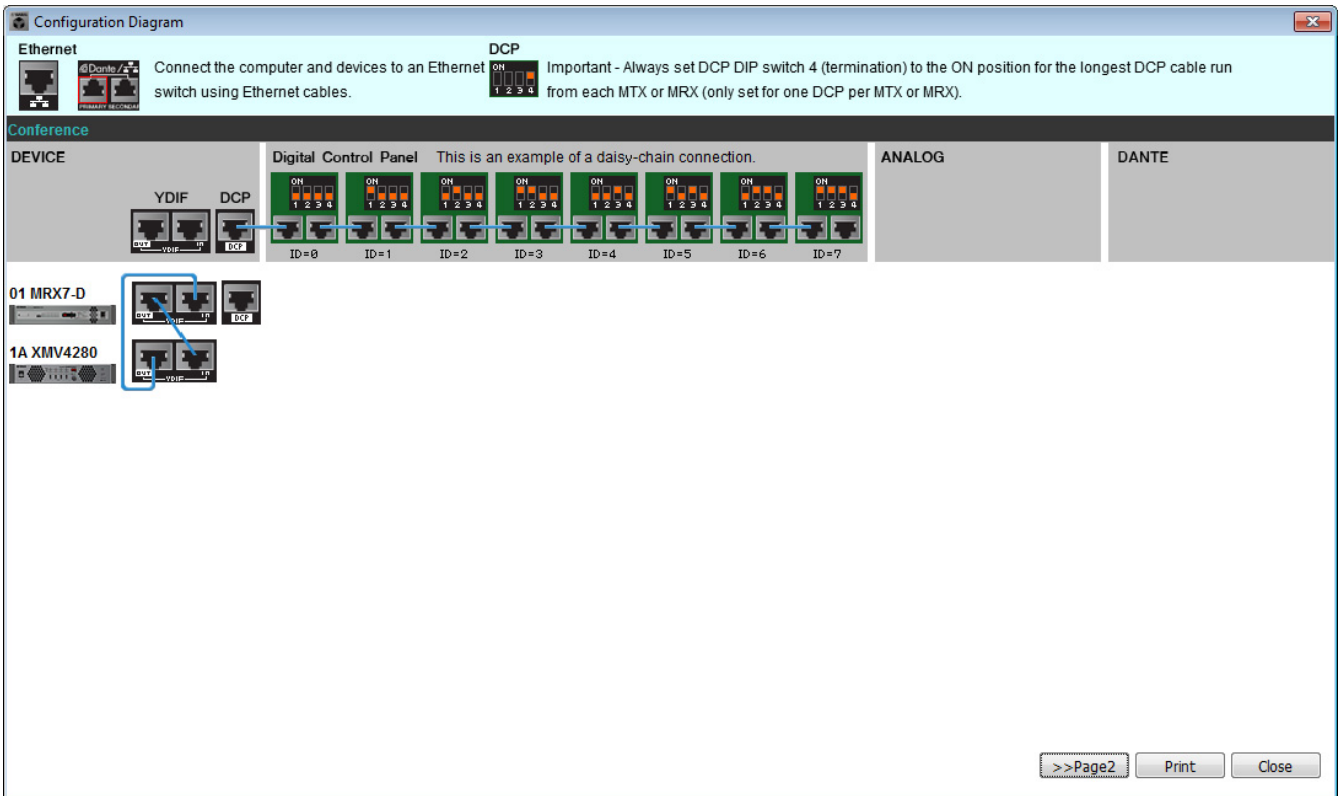

NOTE

If you want to view the cabling diagram again, do so by choosing [File] menu → [Print Configuration Diagram].

If you want to use the Device Configuration Wizard to change the device configuration, click the [Device Config] button in the Project screen.

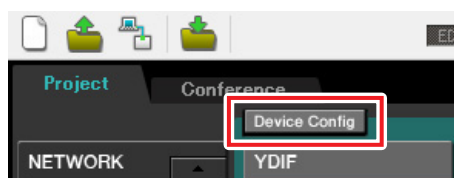

Configuring the settings on the MRX

Placing and connecting the components

Use the MRX Designer to set an internal configuration on the MRX.

When you've finished making settings, you should save them by clicking [File] menu, then [Save].

NOTE

The "User Account Control" dialog box may appear. Click [Continue] or [Yes].

Starting the MRX Designer

Click the tab for the system name that you set in step 1 of "Using the Device Configuration Wizard to create your device setup" to go to the settings screen.

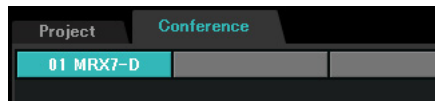

After going to the settings screen, click the [Open MRX Designer] button to start the MRX Designer.

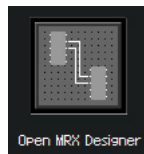

Placing and connecting the components related to the mics in the local location that send audio to far-end

Place and connect the components that will send the input signals from the mics in the local location to the remote location.

1. Place the components shown below by dragging them from the "Components" area and dropping them into the Design sheet.

- "ANALOG IN"
- "Acoustic Echo Canceller"
- "HPF" (MONO)
- "Auto Gain Control" (MONO)
- "Fader" (8CH)
- "Dugan Automixer" (8CH)

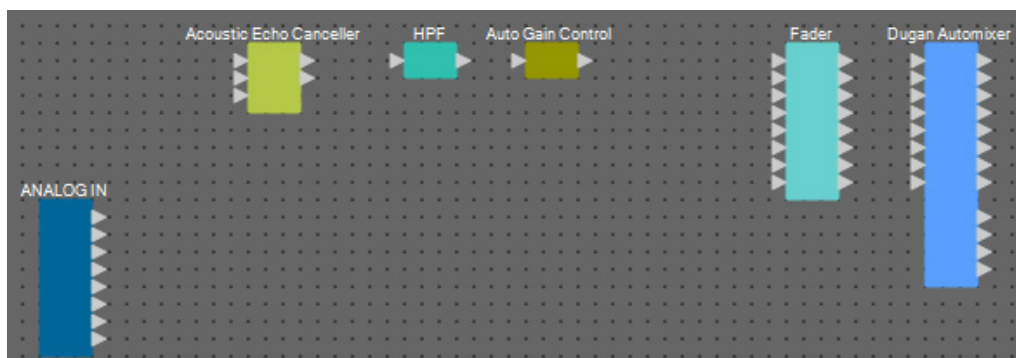

2. Drag and drop the components between the “HPF” and “Auto Gain Control” ports to connect them.

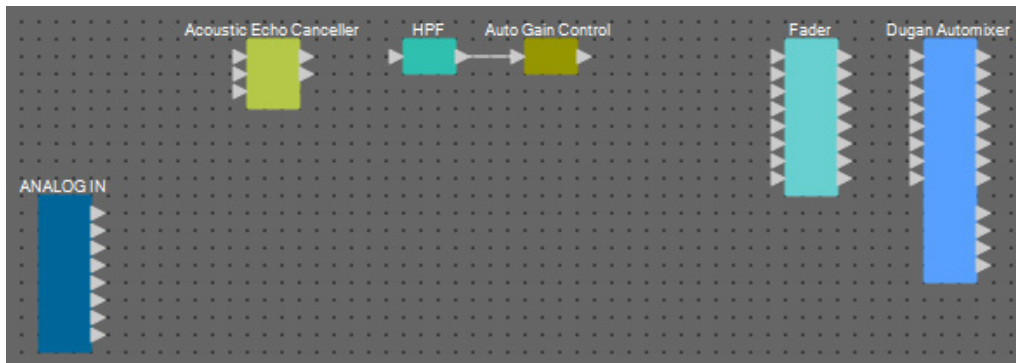

3. Select the area between “HPF” and “Auto Gain Control”, so that the components and wires are selected.

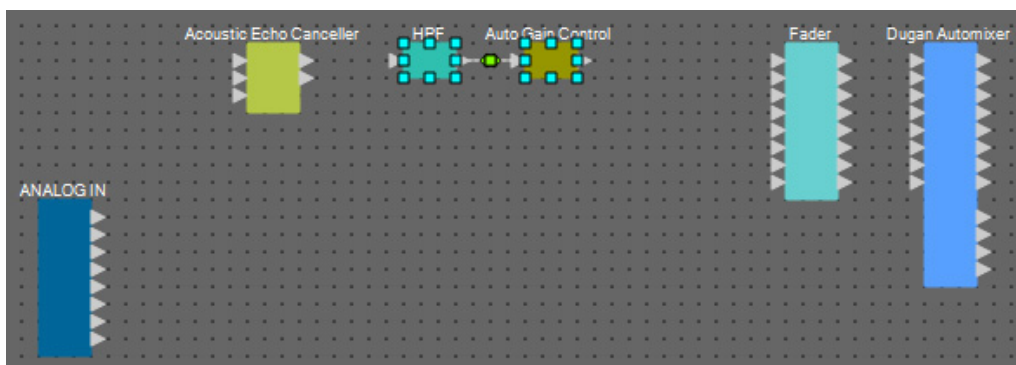
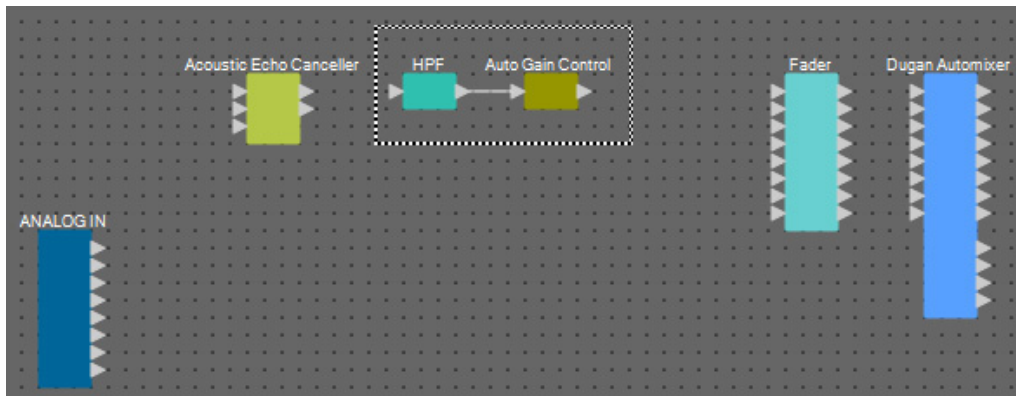

4. Copy the selected components and wires and paste once, or drag and drop the selected components and wires while holding down <Ctrl>.

Change the placement of the components as need be.

Here's how to copy:

- <Ctrl> + <C>
- Right-click and select [Copy] from the context menu
- Select [Copy] from the [Edit] menu

Here's how to paste:

- <Ctrl> + <V>
- Right-click and select [Paste] from the context menu
- Select [Paste] from the [Edit] menu

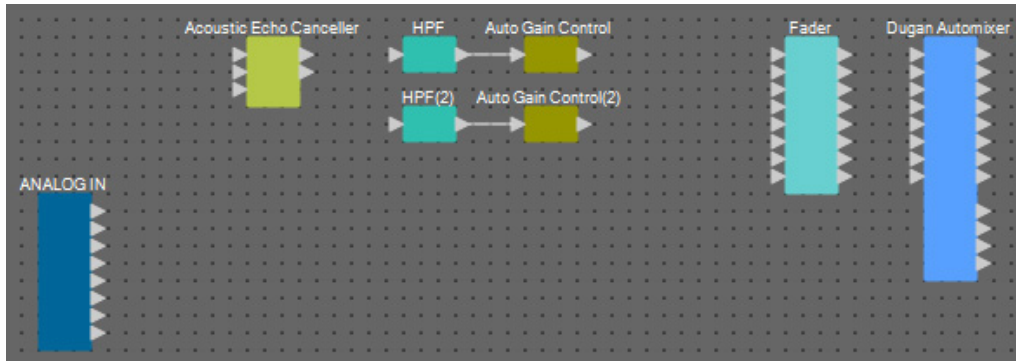

5. Drag and drop the components between the “Acoustic Echo Canceller”, “HPF” and “HPF(2)” ports to connect them.

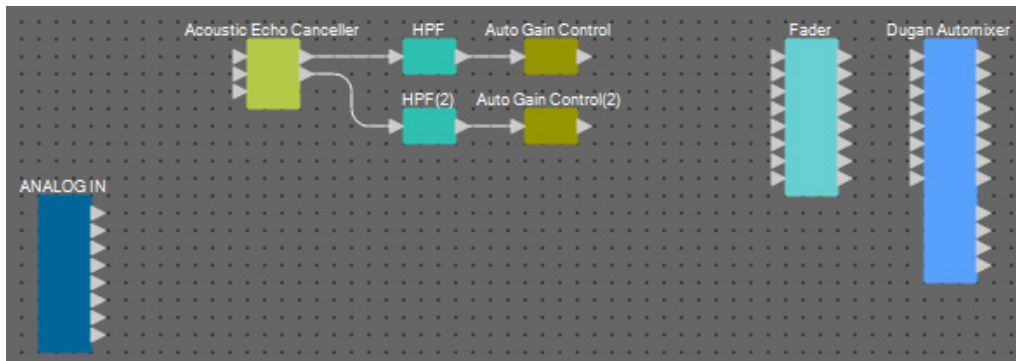

6. Select the area between “Acoustic Echo Canceller” and “Auto Gain Control”; so that the components and wires are selected.

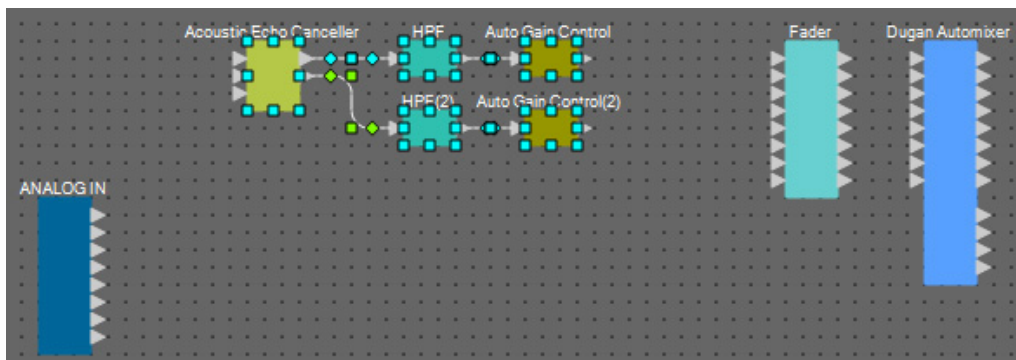

- Copy the selected components and wires and paste four times, or drag and drop the selected components and wires while holding down <Ctrl>.

Change the placement of the components as need be.

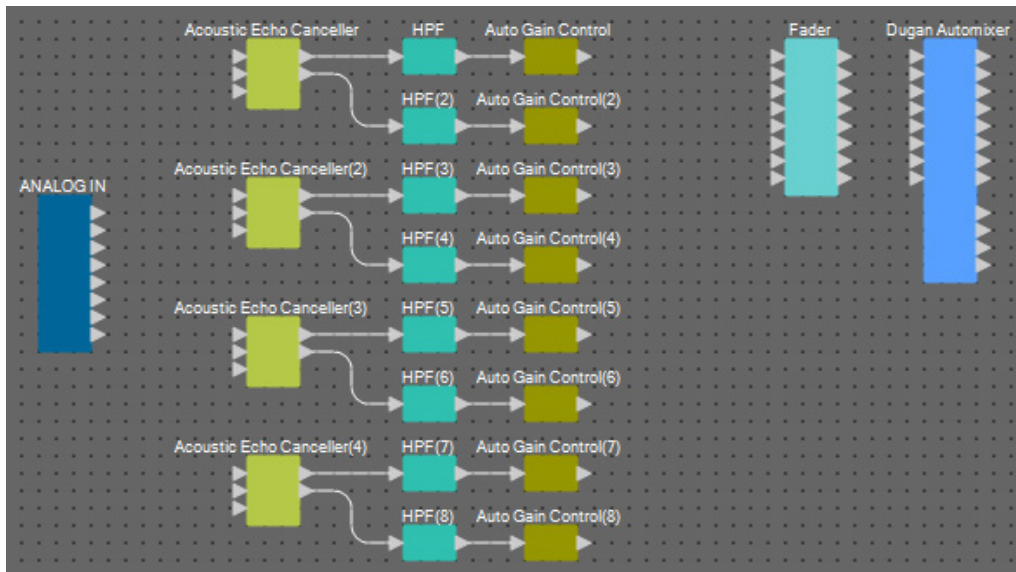

- Connect the “ANALOG IN” 1 through 8 ports and the Mic In 1/2 port for each “Acoustic Canceller” by dragging and dropping.

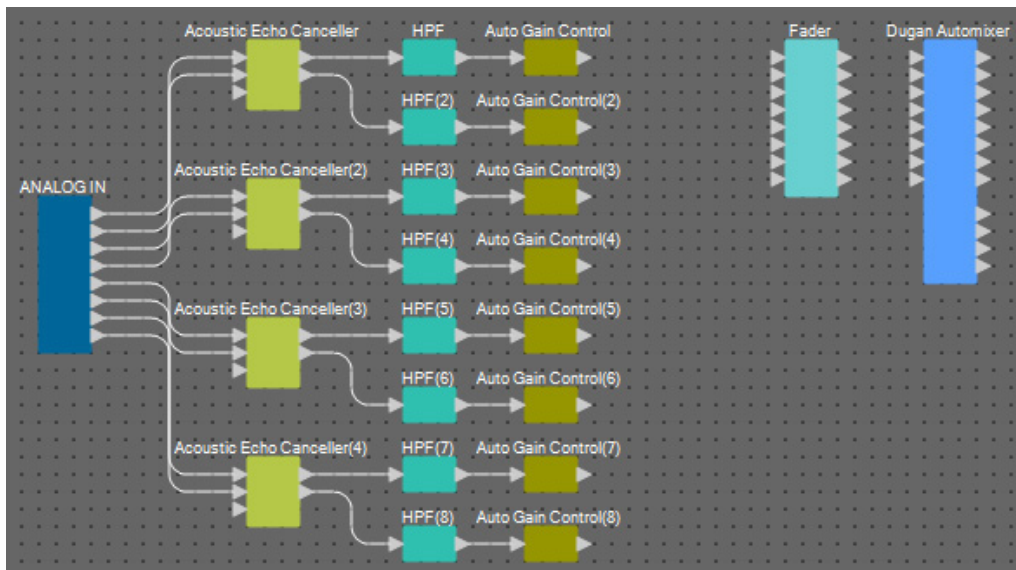

9. Drag and drop between the “Auto Gain Control” output ports and the “Fader” input ports to connect them.

Select the “Auto Gain Control” output port area, and drag and drop them all at once to the “Fader” input ports to connect them.

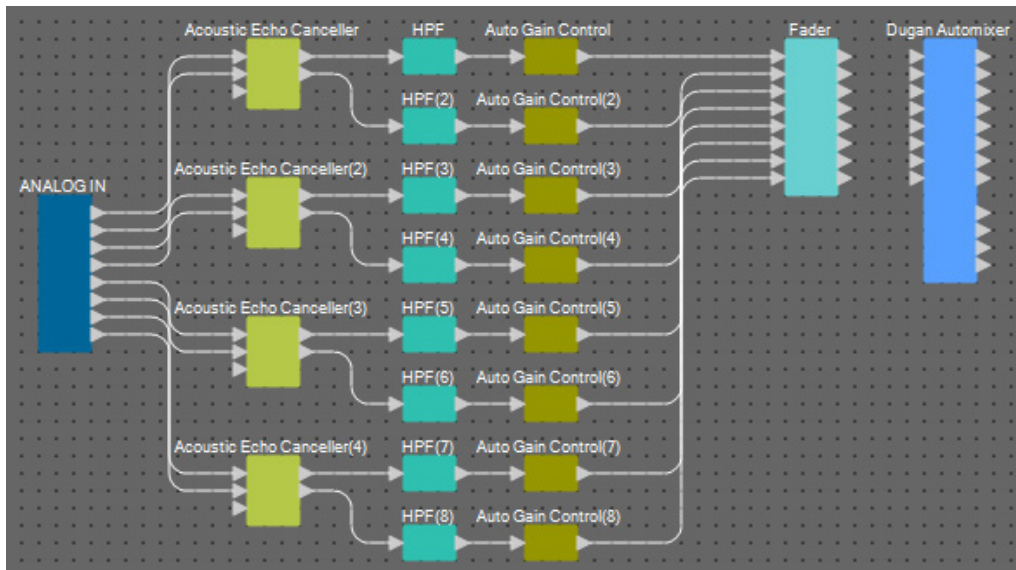

10. Drag and drop between the “Fader” output ports and the “Dugan Automixer” input ports to connect them.

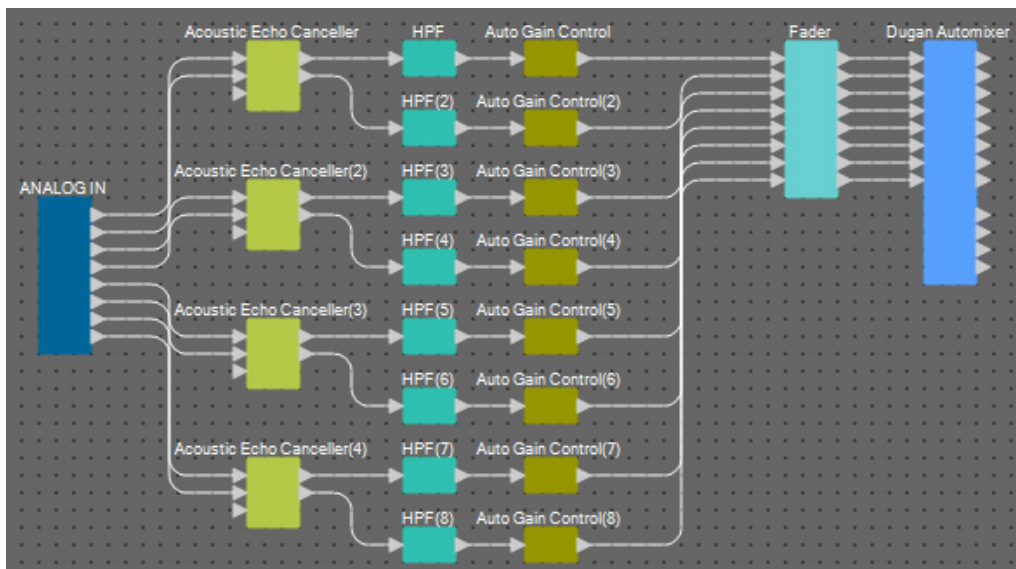

■ Placing and connecting the components not related to the mics in the local location that send audio to far-end

Now we'll bring the audio signal inputs from the AUX L/R and remote location to the MRX7-D [ST-IN] connectors.

1. Place the components shown below by dragging them from the “Components” area and dropping them into the Design sheet.

- “STEREO IN”
- “PEQ” (STEREO, 3BAND)
- “PEQ” (MONO, 3BAND)
- “Fader” (2CH) × 2
- “Fader” (1CH)
- “Matrix Mixer” (IN=4, OUT=4)
- “PEQ” (STEREO, 4BAND)
- “PEQ” (MONO, 4BAND)

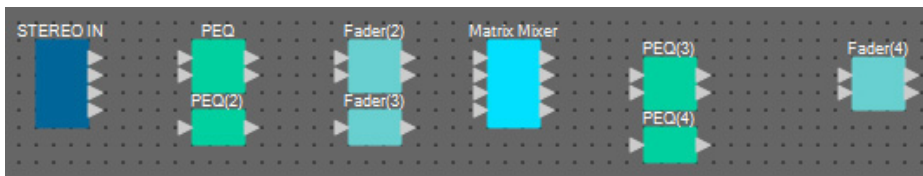

2. Click the “STEREO IN” port, and click the button that’s located at the right of the edit area in “Properties.”

The “Port Name” dialog box will appear.

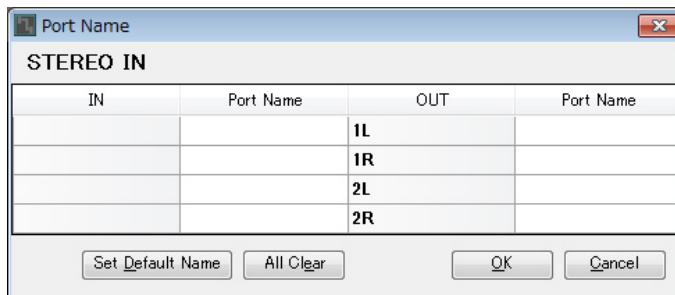

3. Enter the port name, and click the [OK] button.

In this example, 1L is named as “Aux L”, 1R as “Aux R”, and 2L as “Codec In”.

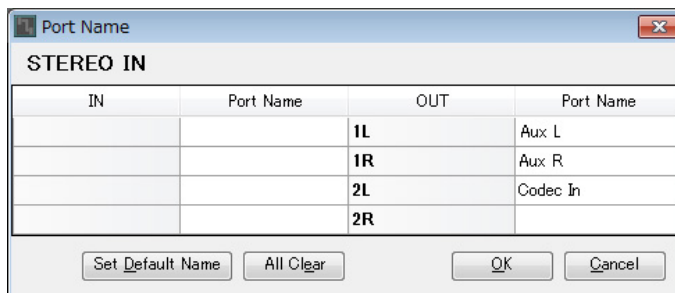

4. Connect the space between “STEREO IN” output ports 1/2 to the “Matrix Mixer” input ports 1/2 by dragging and dropping.

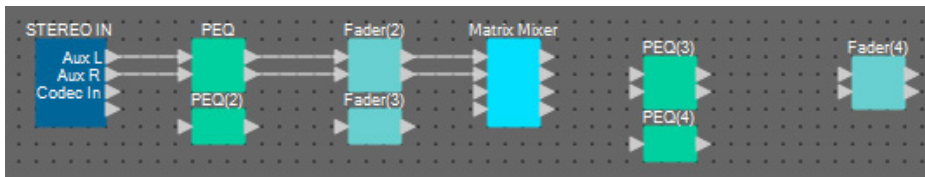

5. Connect the space between “STEREO IN” output port 3 to the “Matrix Mixer” input port 3 by dragging and dropping.

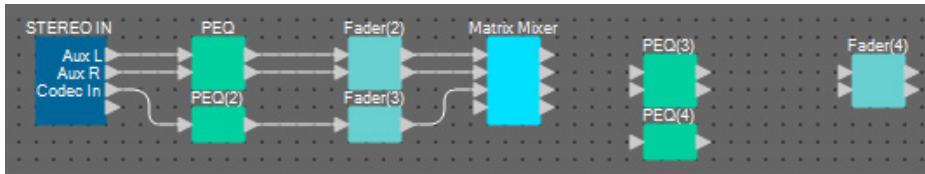

6. Connect the space between “Matrix Mixer” output ports 2/3 to “Fader(4)” input ports 1/2 by dragging and dropping.

Output port 1 of the “Matrix Mixer” will be used to send the Aux signal to the remote location. Output ports 2/3 of the “Matrix Mixer” will be used to output to the speakers in the local location. Output port 4 of the “Matrix Mixer” will be used as an input to the AEC reference.

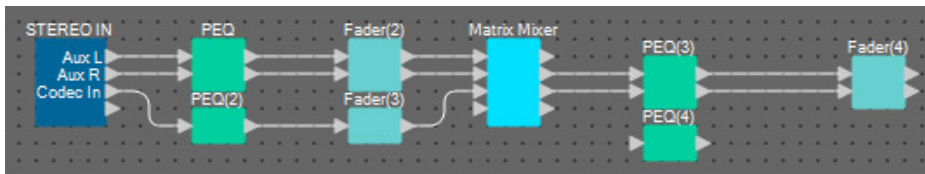

7. Connect the space between the “Matrix Mixer” output port and the “PEQ(4)” input port 1 by dragging and dropping.

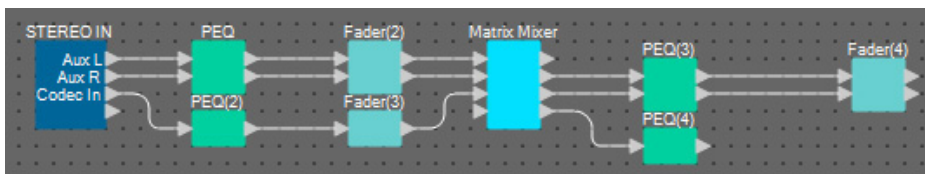

- Connect the output port of “PEQ(4)” to each Reference port of the “Acoustic Echo Canceller” by dragging and dropping.

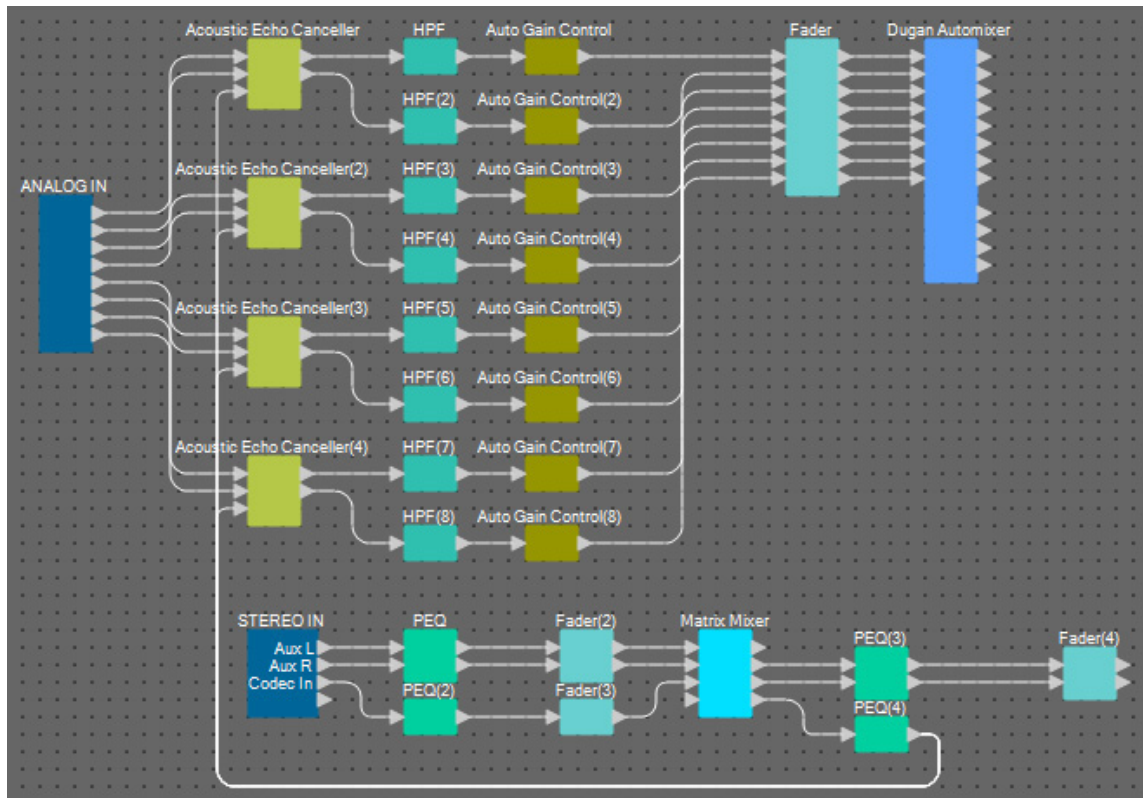

- Double-click the “Matrix Mixer.”

The “Matrix Mixer” component editor will appear.

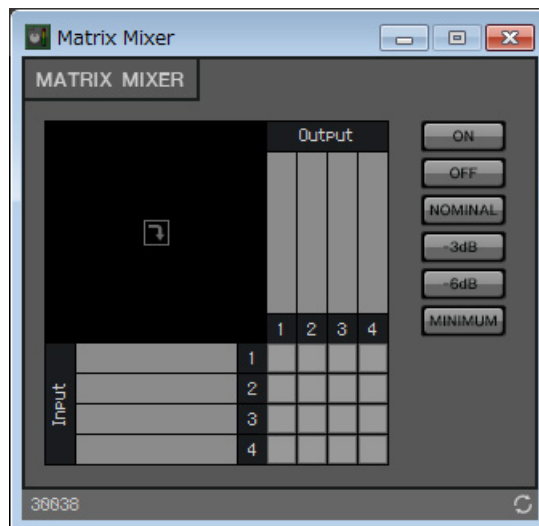

10. Double-click the area where the Input 1 port name is displayed.

The “Port Label” dialog box will appear.

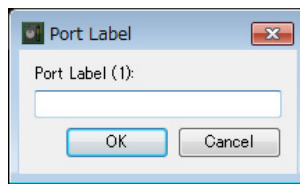

11. Input [Aux L] and click the [OK] button.

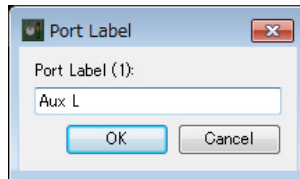

12. Repeat steps 10 and 11 to input the names for the other ports.

In this example, we’ve used the following names.

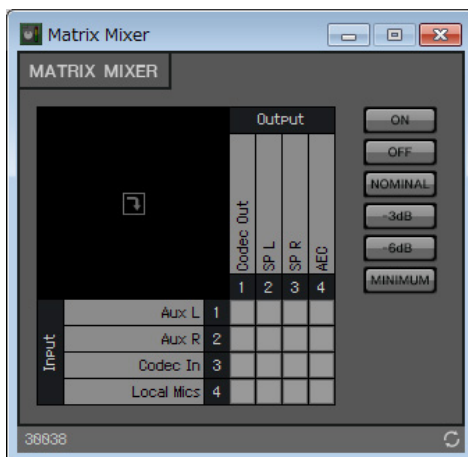

Input	1	Aux L
	2	Aux R
	3	Codec In
	4	Local Mics
Output	1	Codec Out
	2	SP L
	3	SP R
	4	AEC

13. Click the spaces to turn the sends on, as shown in the image below.

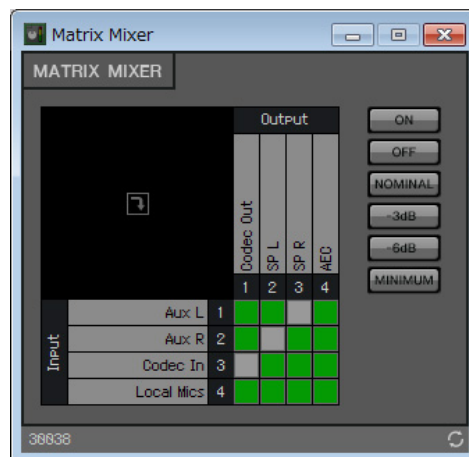

14. Click the [x] button at the top right-hand corner to close the component editor.

■ **Placing and connecting the components related to the mics for the Near-end voice**

Set the input from the mics so that they will output to the speakers at the local location.

1. Place the components shown below by dragging them from the “Components” area and dropping them into the Design sheet.

- “HPF” (MONO)
- “PEQ” (MONO, 4BAND)
- “Fader” (8CH)
- “Dugan Automixer” (8CH)

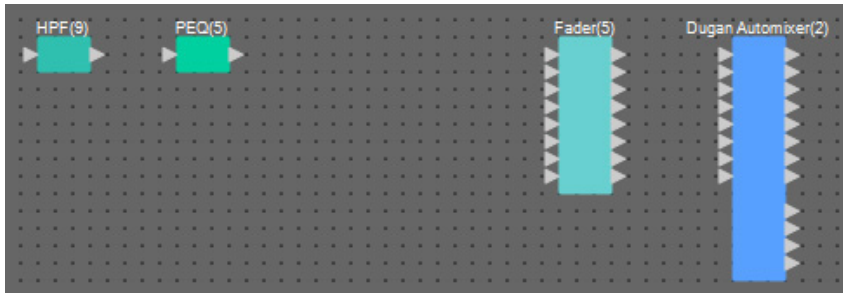

2. Drag and drop the components between the “HPF(9)” and “PEQ(5)” ports to connect them.

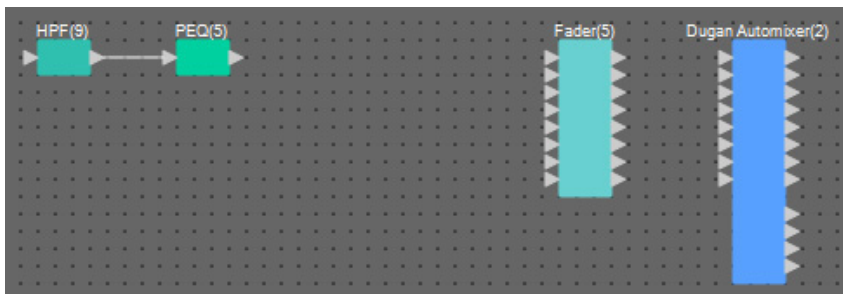

3. Select the area between “HPF(9)” and “PEQ(5)”, so that the components and wires are selected.

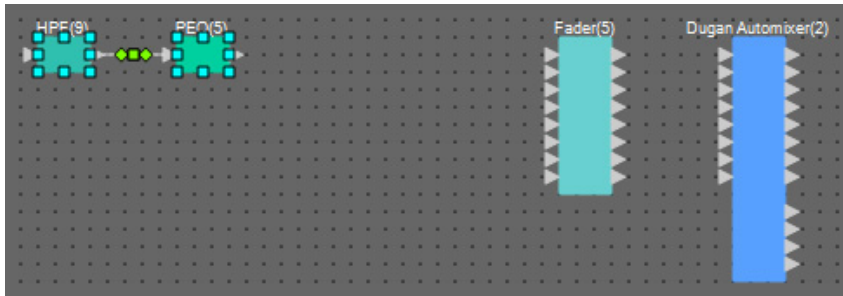

4. Copy the selected components and wires and paste seven times, or drag and drop the selected components while holding down <Ctrl>.

Change the placement of the components as need be.

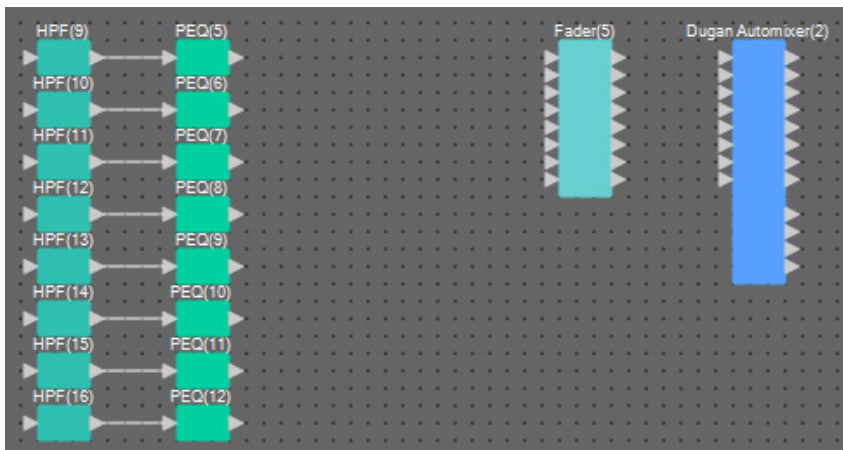

5. Connect the “ANALOG IN” 1 through 8 ports and each “HPF” input port by dragging and dropping.

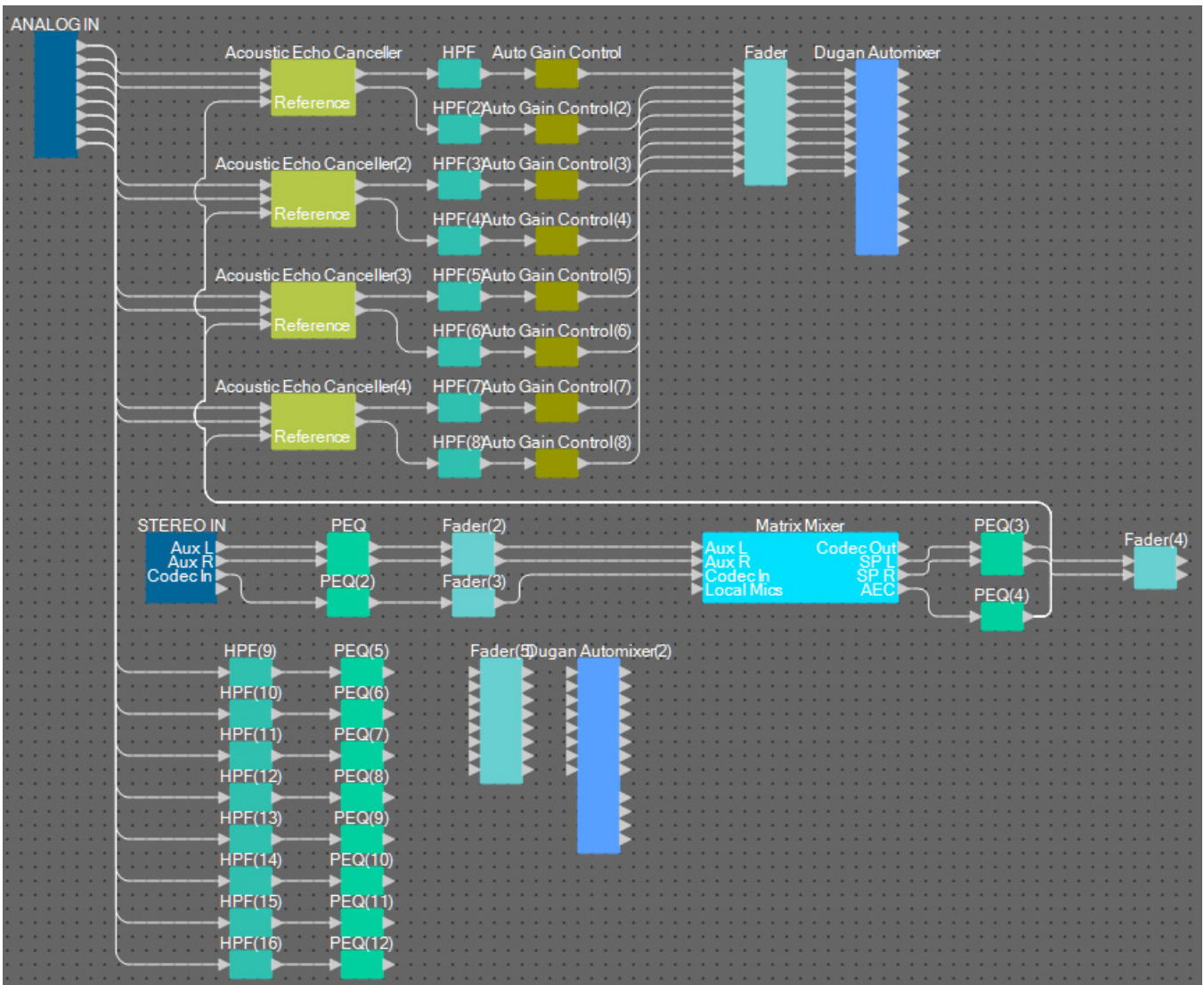

6. Drag and drop between each “PEQ” output port and the “Fader” input ports to connect them.

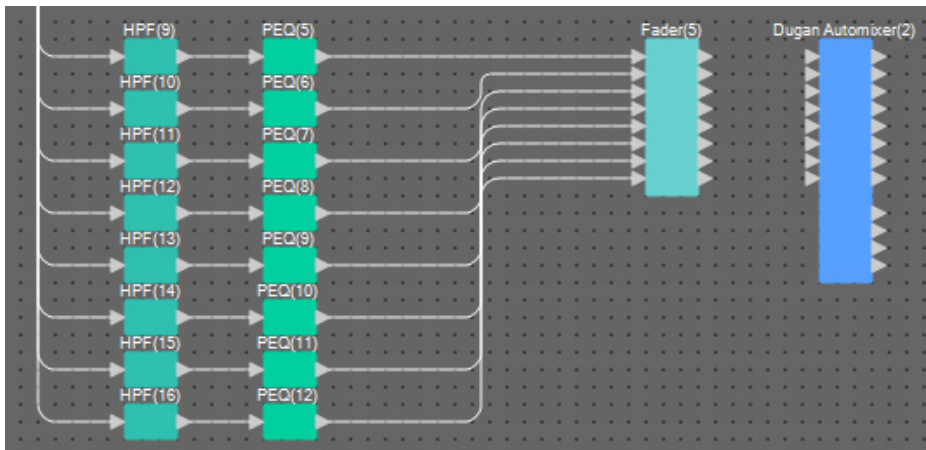

7. Drag and drop between the “Fader(5)” output ports 1 through 8 and the “Dugan Automixer” input ports 1 through 8 to connect them.

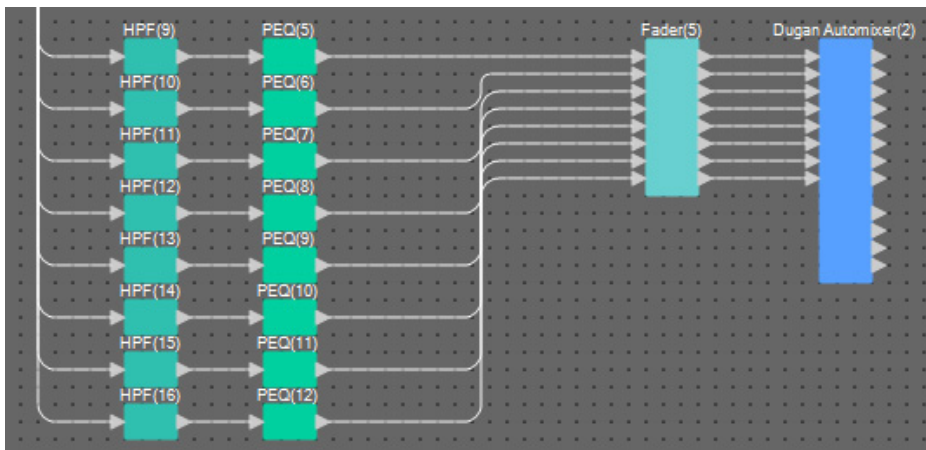

8. Drag and drop between “Dugan Automixer(2)” output port a and the “Matrix Mixer” input port 4 to connect them.

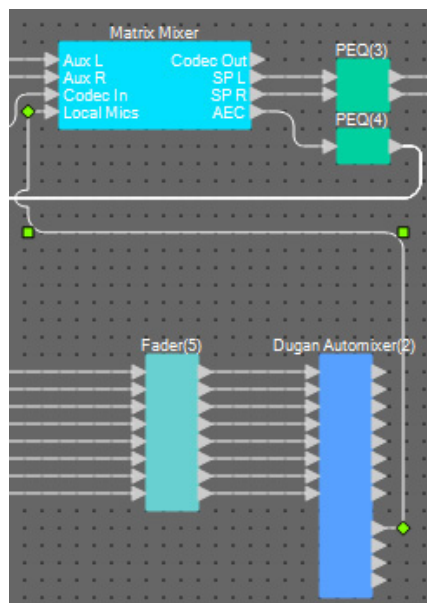

■ Placing and connecting the components related to the mics for output

Here we will place and connect the components related to the conference room speakers, the hallway speakers, and output to CODEC.

Allocate the “ANALOG OUT” 1 to CODEC, the “YDIF OUT” 1 and 2 to speech privacy (hallway speakers), and the “YDIF OUT” 3 and 4 to the conference room speakers.

1. Place the components shown below by dragging them from the “Components” area and dropping them into the Design sheet.

- “Matrix Mixer”(IN=2, OUT=2)
- “PEQ”(MONO, 4BAND)
- “Fader”(1CH)
- “Speech Privacy”
- “PEQ”(STEREO, 4BAND)
- “Fader”(2CH)
- “ANALOG OUT”
- “YDIF OUT”

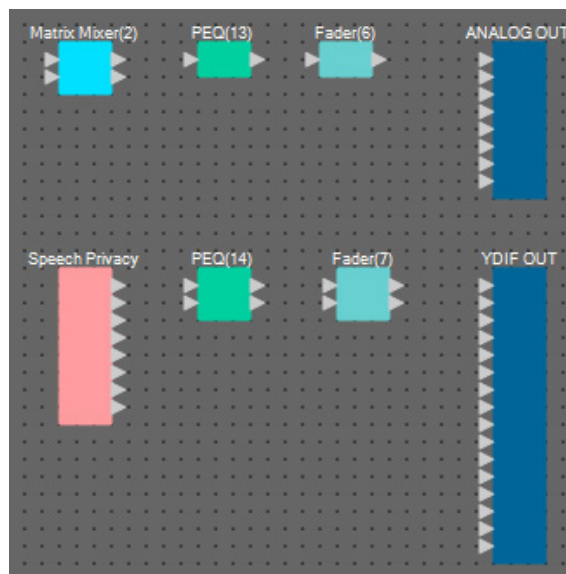

2. Drag and drop between the “Dugan Automixer” output port a and the “Matrix Mixer(2)” input port 1 to connect them. Drag and drop between the “Matrix Mixer” output port 1 (Codec Out) and the “Matrix Mixer(2)” input port 2 to connect them.

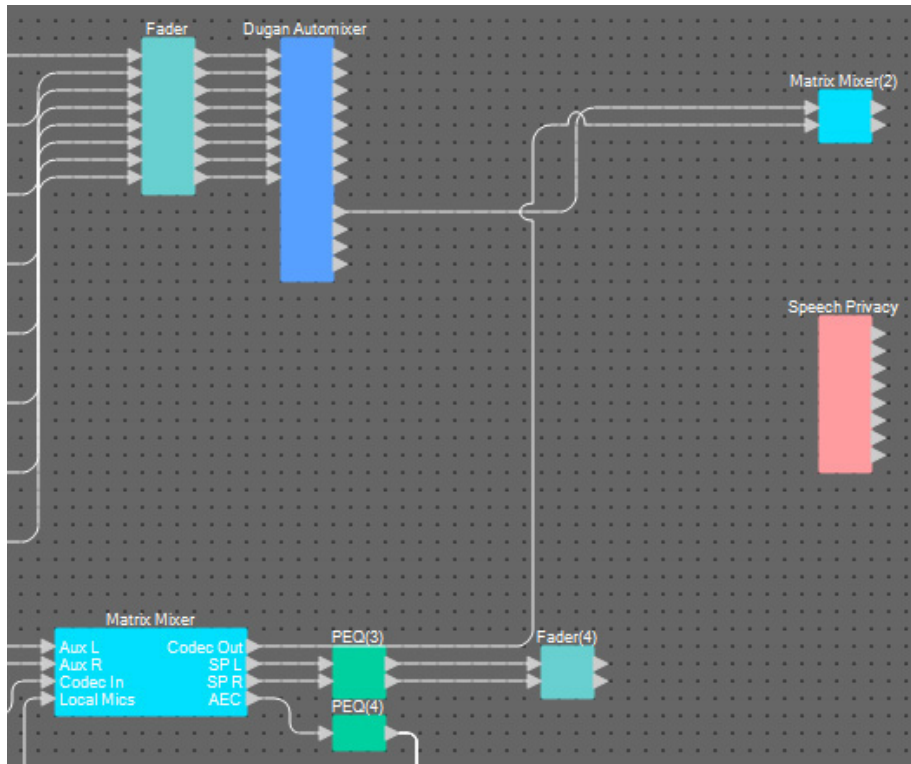

3. Drag and drop between the “Matrix Mixer(2)” output port 1 and the “ANALOG OUT” input port 1 to connect them.

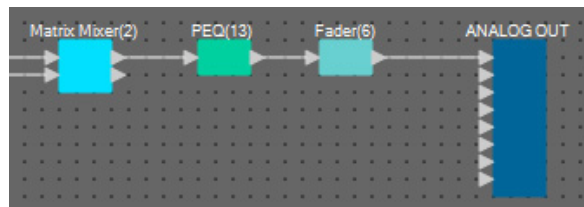

4. Double-click the “Matrix Mixer(2).”
The Matrix Mixer component editor will appear.



5. Click the spaces to turn the sends on, as shown in the image below.



6. Click the [x] button at the top right-hand corner to close the component editor.

7. Drag and drop from between the “Speech Privacy” output port 1 and the 1W/Offset to the “YDIF OUT” input ports 1 and 2 to connect them.

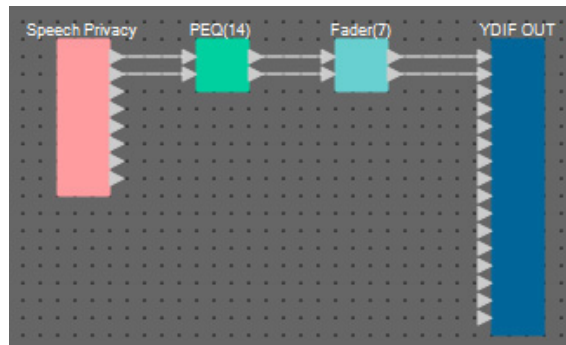

8. Double-click “Speech Privacy.”

The Speech Privacy component editor will appear.



9. Select “Building” on the [Environmental Sound] list box for source 1, and click the [ON] button for source 1 to turn it on.

Set the environmental sound to “Building” (air-conditioner sound) to send speech privacy sounds through the hall-way speakers.



10. Click the [x] button at the top right-hand corner to close the component editor.
11. Drag and drop from between the “Fader(4)” output ports 1 and 2 to the “YDIF OUT” input ports 3 and 4 to connect them.

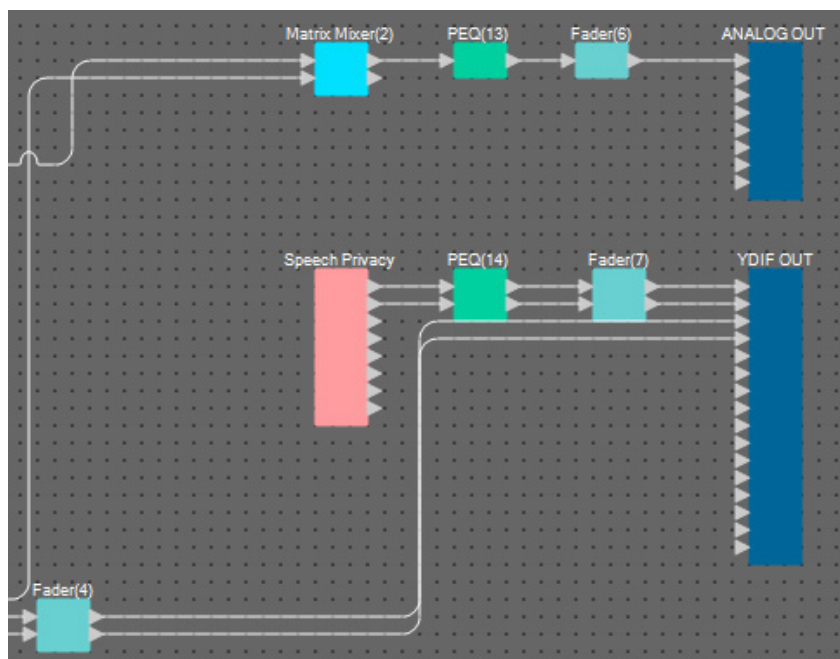

Now you’re finished placing and connecting the components. Change the placement of the components and change the wiring as need be.

Compiling

This analyzes the placement and wiring of the components in the MRX, to determine whether there are any problems.

1. Click the [Compile] tool button ( Compile).

Start the analysis.

2. Confirm the analysis results.

If the message “Completed successfully” is displayed in the “Message” field, there were no problems.

If a problem was detected, click the [Detail] button to check how to solve the problem and to correct it.

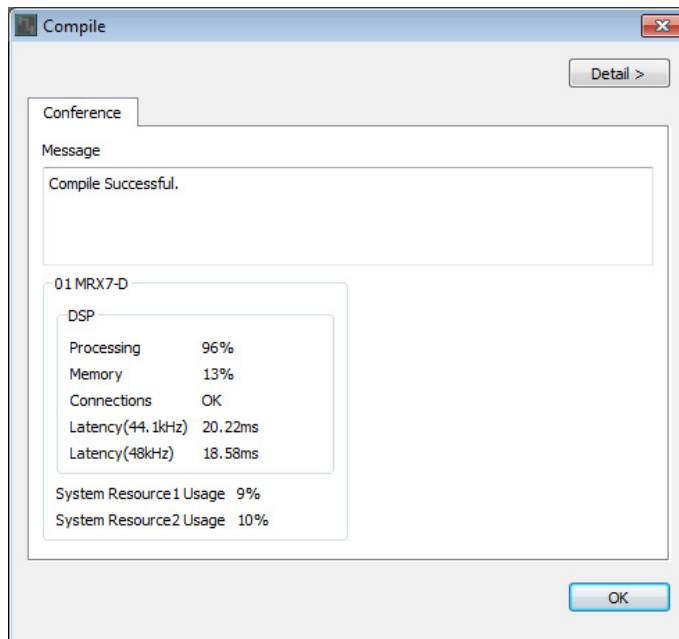

Now you're finished compiling.

Setting a parameter link group

In this example, we'll see how to make it easier to operate in ProVisionaire Touch, such as by assigning a single fader to two faders for stereo output to conference room speakers, or by assigning a single button to activate all of the mic ON buttons.

Here we'll create a parameter link group that links multiple parameters such as levels or ON/OFF, so that we can change multiple parameters at the same time with a ProVisionaire Touch fader or button.

1. Open the “Parameter Link Group” area on the left side of the MRX Designer, in order to check the parameters that are registered.



2. Open the “Parameter” area on the right side of the MRX Designer.

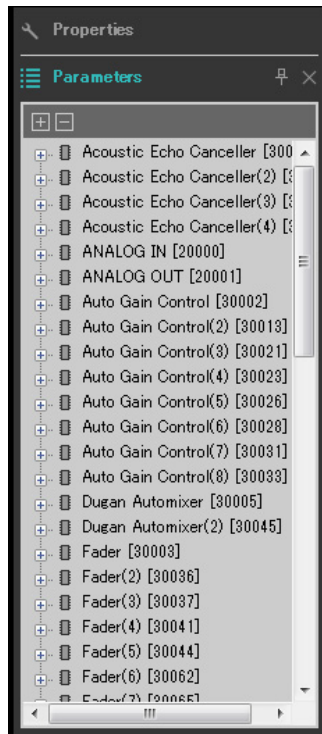

3. Since the conference room speaker levels are adjusted using “Fader(4)”, open [Fader(4)] in the “Parameters” area.

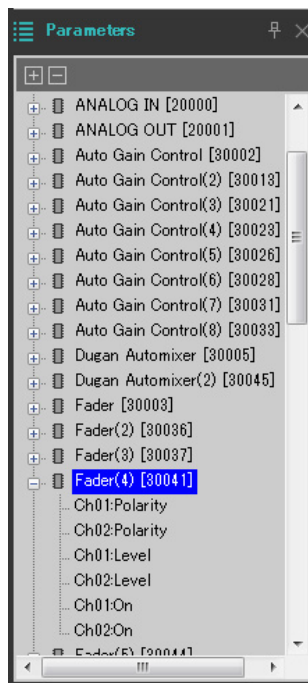

4. After clicking [Ch01:Level], hold down <Ctrl> and click [Ch02:Level].

You can select multiple items while holding down <Ctrl> and clicking.

To select continuous parameters, click the start parameter, hold down the <Shift> key and then click on the end parameter.

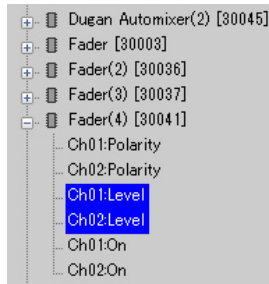

5. Do a right-click and select [Add to Parameter Link Group] → [Add New Group].

A dialog box for setting the parameter link group name will open.

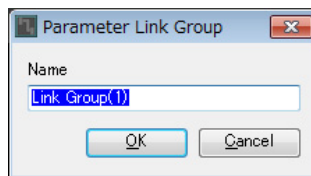

6. Input [Speaker Level] and click the [OK] button.

The [Speaker Level] group will be generated in the “Parameter Link Group” area, and the Link Master editor will appear.

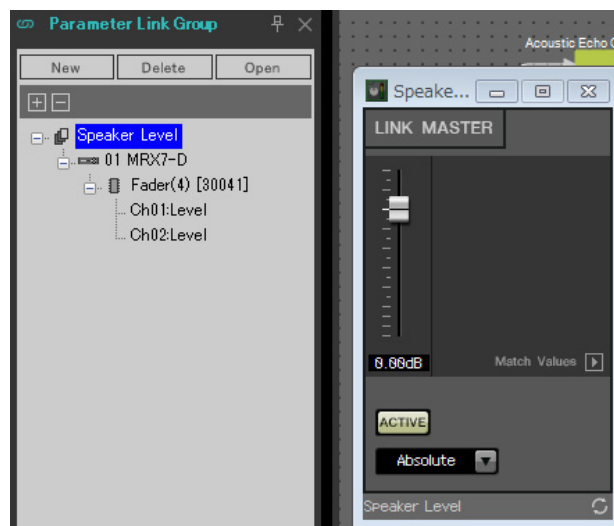

7. Select [Absolute] on the Link Master editor combo box.

8. Double-click “Fader(4).”

The “Fader(4)” component editor will appear.

9. Move the fader in the Link Master editor, and confirm that the “Fader(4)” component editor faders are linked together.

10. Click the [x] button at the top right-hand corner of the “Fader(4)” component editor to close the component editor.

Now open the Link Master editor, as we will be using it to register the Remote Control Setup List.

Repeat step 2 through 10 to create the following parameter link groups.

Parameter link group name	Components	Parameters	Link Master editor combo box settings
Mics On/Off	[Fader(5)]	Ch01:On	Absolute
		Ch02:On	
		Ch03:On	
		Ch04:On	
		Ch05:On	
		Ch06:On	
		Ch07:On	
		Ch08:On	

Now you’re finished setting the parameter link group.

Creating the Remote Control Setup List used by ProVisionaire Touch

To change the parameters by operating the ProVisionaire Touch, register the parameters in the Remote Control Setup List, and output the file. Add the outputted rsl file as a document to ProVisionaire Touch on the iPad.

Register the following parameters in the Remote Control Setup List. The steps for registering will be explained later.

No.	Component or parameter link group that includes the registered parameters	Parameters
001	Speaker Level	Link Master fader
002	Mics On/Off	[ON] button for Link Master
003	Speech Privacy	Source 1 [ON] button

Now we'll explain how to register the Remote Control Setup List. This time, we'll explain how to do this by dragging and dropping the parameters while holding <Ctrl> using the component editor and so on; but you can also drag and drop from the "Parameters" area.

1. Select [Remote Control Setup List] in the [Tools] menu.

The "Remote Control Setup List" dialog box will appear.

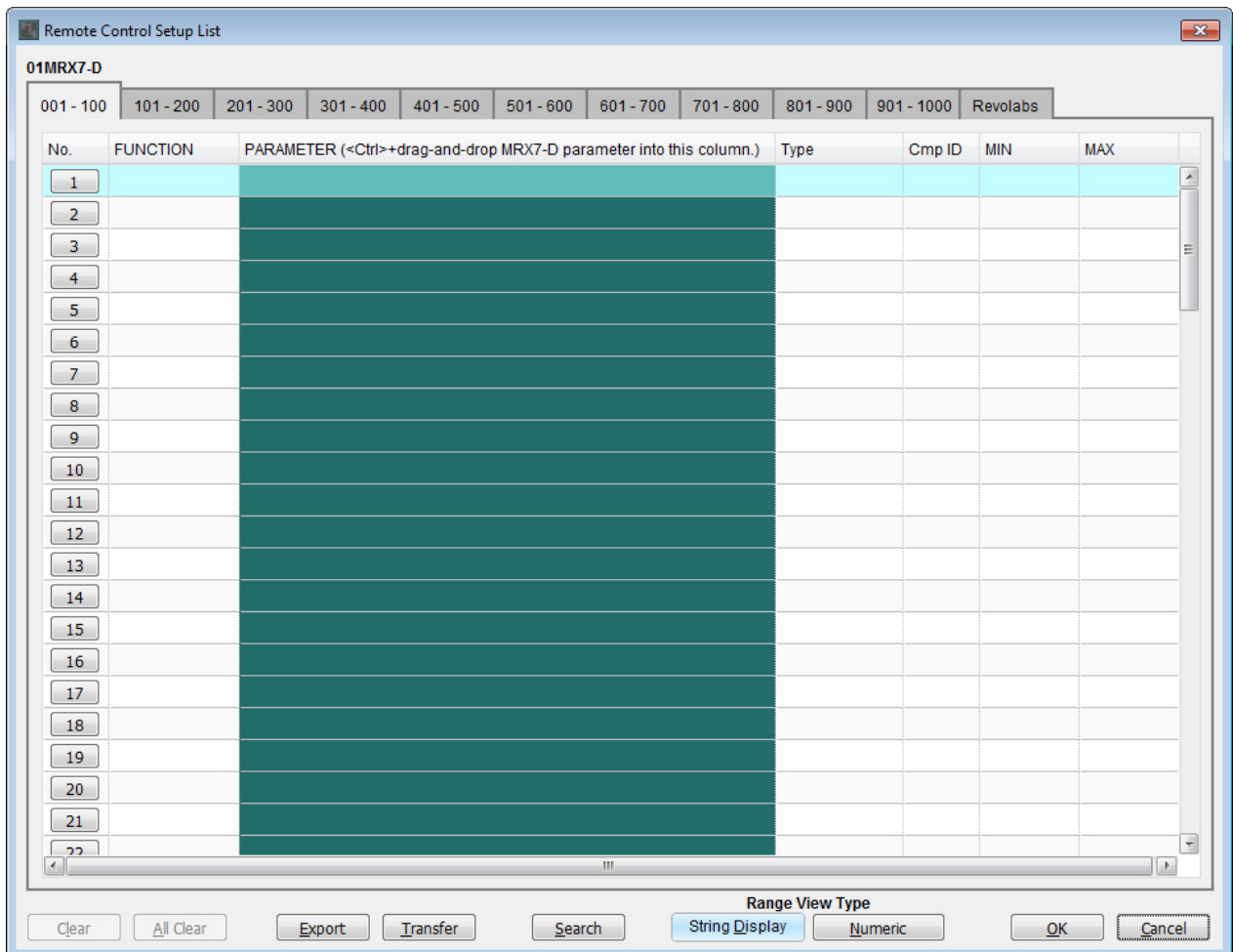

2. Click the Link Master editor for the “Speaker Level.”

The focus will move to the Link Master editor for the “Speaker Level.” If the Link Master editor is closed, right-click on “Speaker Level” in the parameter link group area and select [Open Link Master] from the context menu to display it.

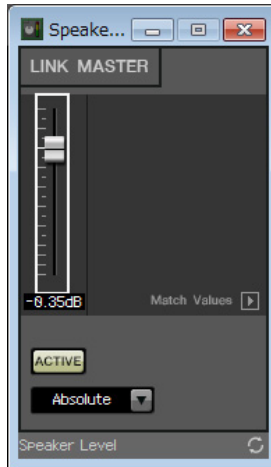

3. Drag and drop the Link Master editor fader to the “PARAMETER” area in line No.001 of the “Remote Control Setup List” dialog box, while holding down <Ctrl>.

The “Speaker Level” fader will be registered.

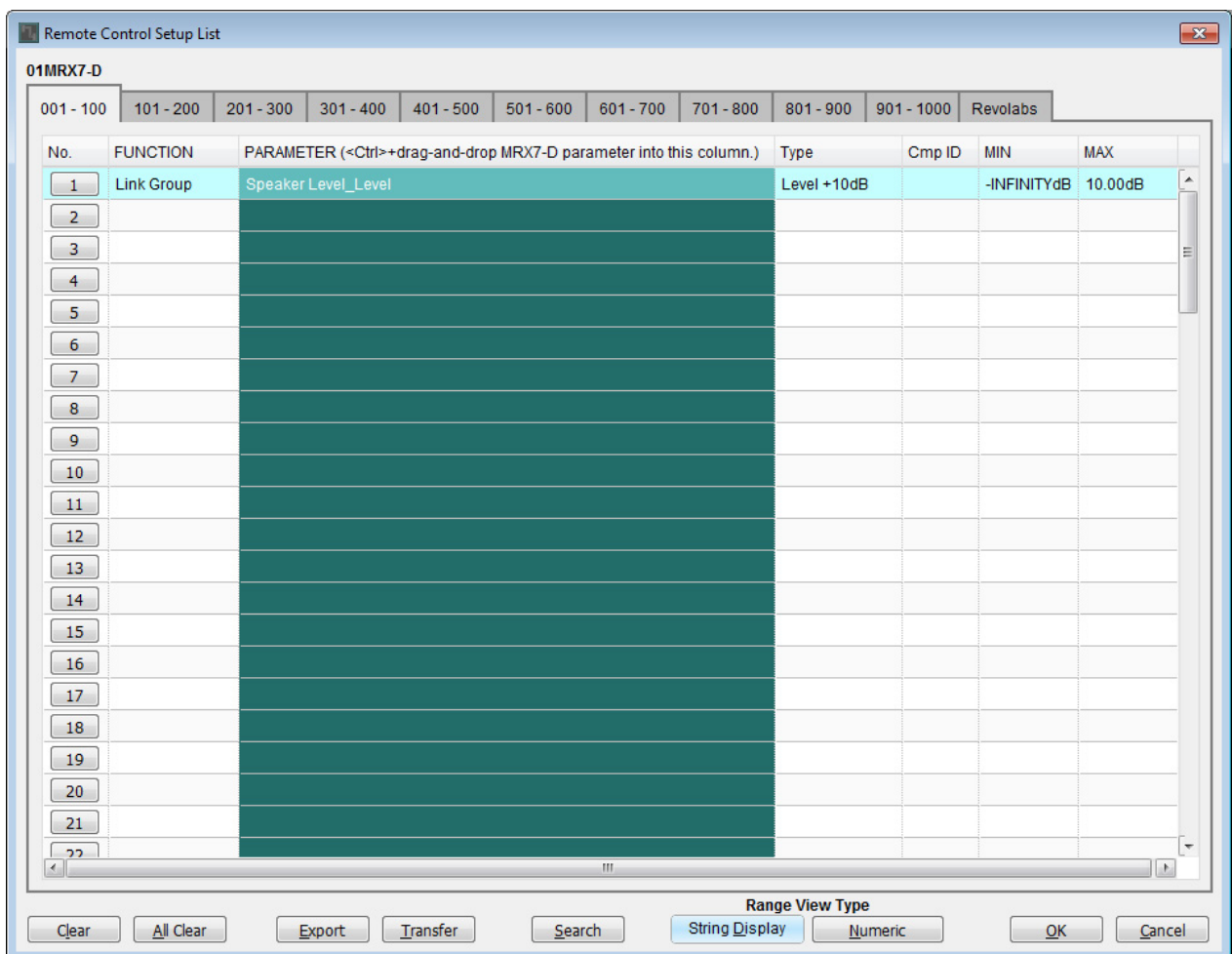

4. Register the other parameters as shown in steps 2 through 3.

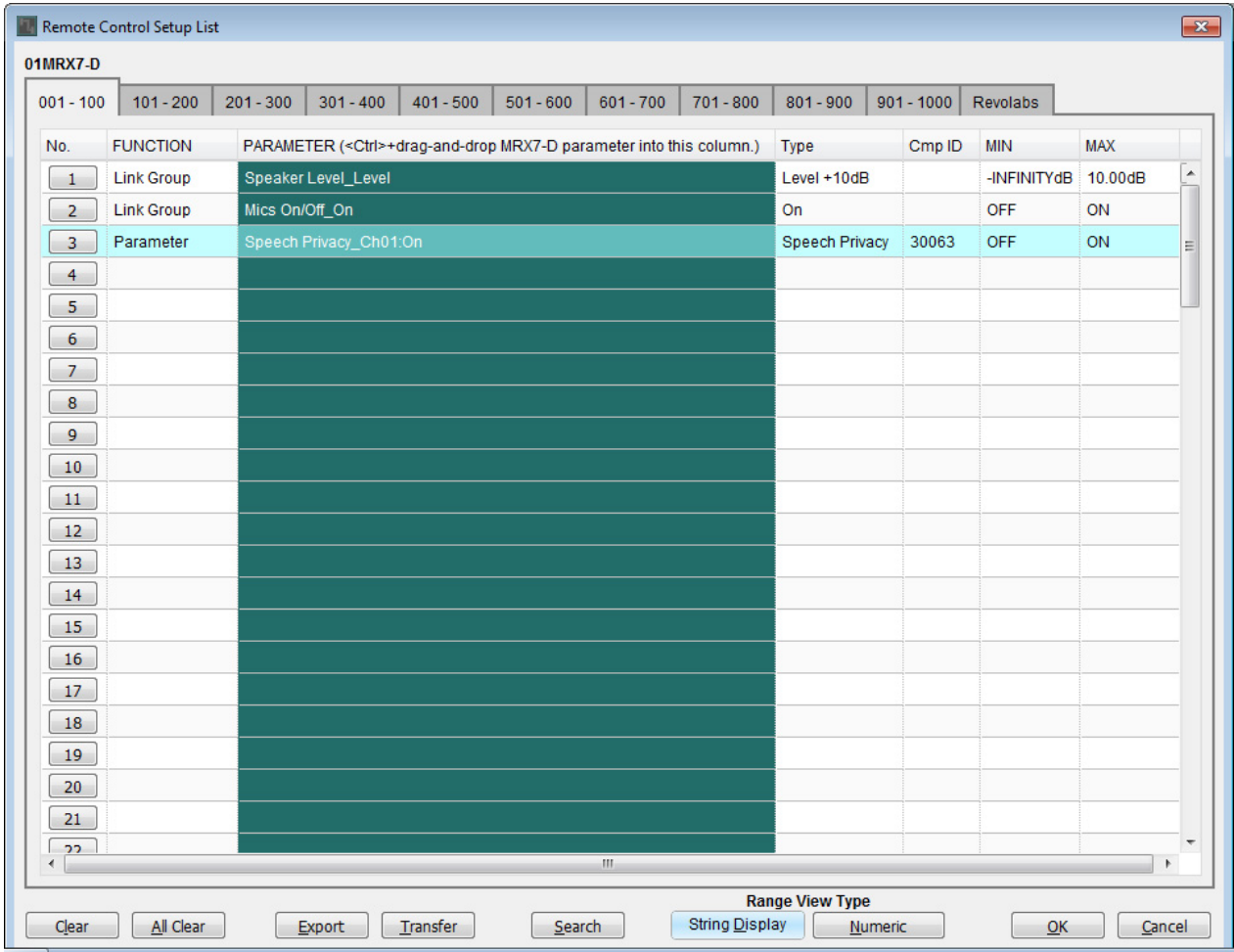

5. Click the [Export] button.

The file save dialog box will appear.

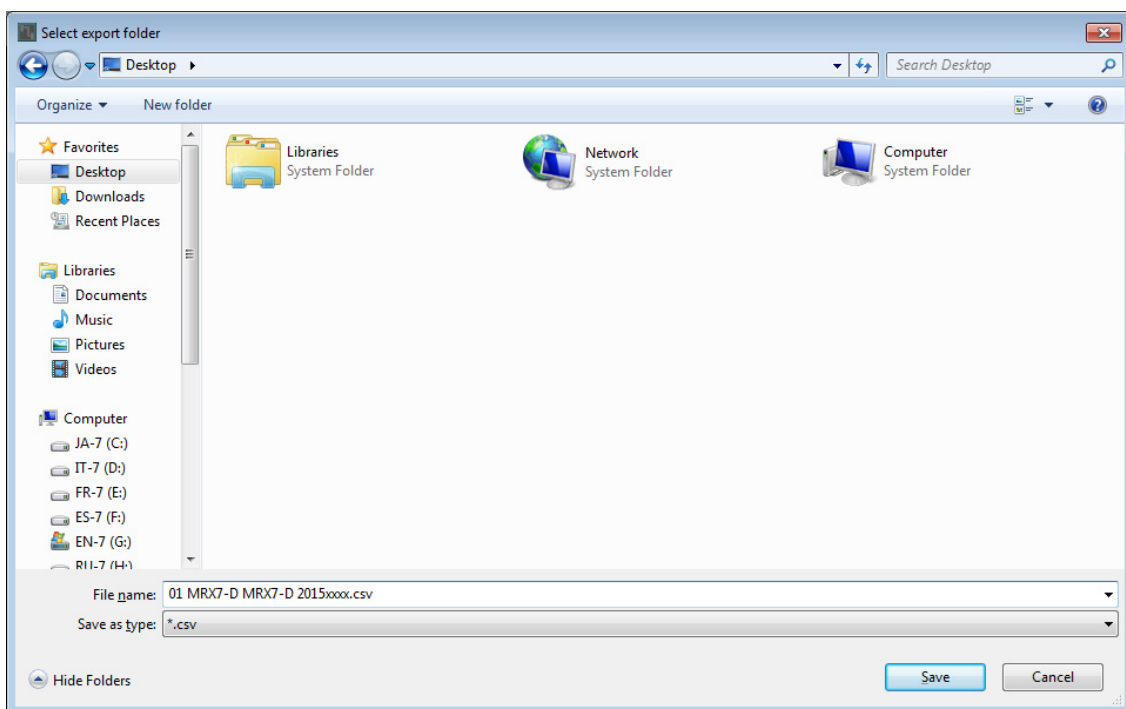

6. Change the “File type” to “rcsl.”

The file extension will change to “rcsl.”

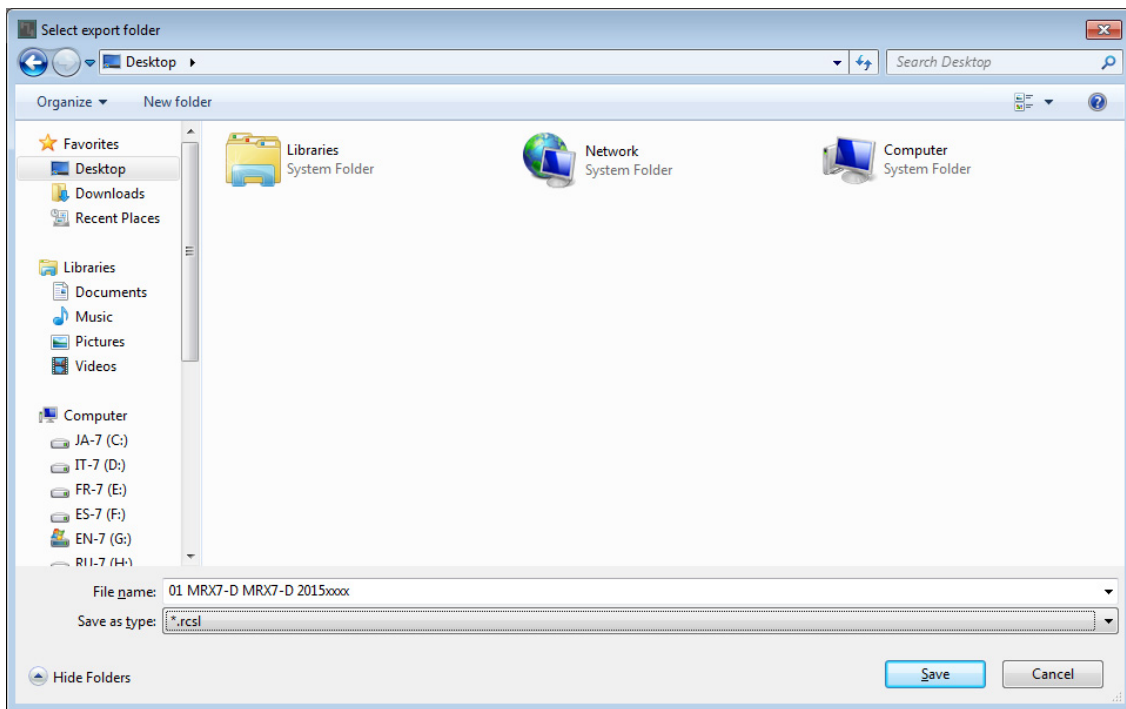

7. Select the desired folder and change the file name as desired, and click the [Save] button.

The Remote Control Setup List used by ProVisionaire Touch will be saved.

8. Click the [OK] button on the “Remote Control Setup List” dialog box.

The “Remote Control Setup List” dialog box is closed.

9. Click the [x] buttons at the top right-hand corner of the Link Master editor and the component editor to close the editor and component editor.

Now you’ve finished registering the Remote Control Setup List. Refer to the “ProVisionaire Touch Setup Guide” to learn how to use ProVisionaire Touch.

The created file can be transmitted with “File Transfer” application. Refer to the “MRX Designer User Guide” for how to use application.

Storing a preset

You'll need to set which preset will be recalled when the MRX is started up.

1. Click the [Preset] tool button ().

The "Preset" dialog box will appear.

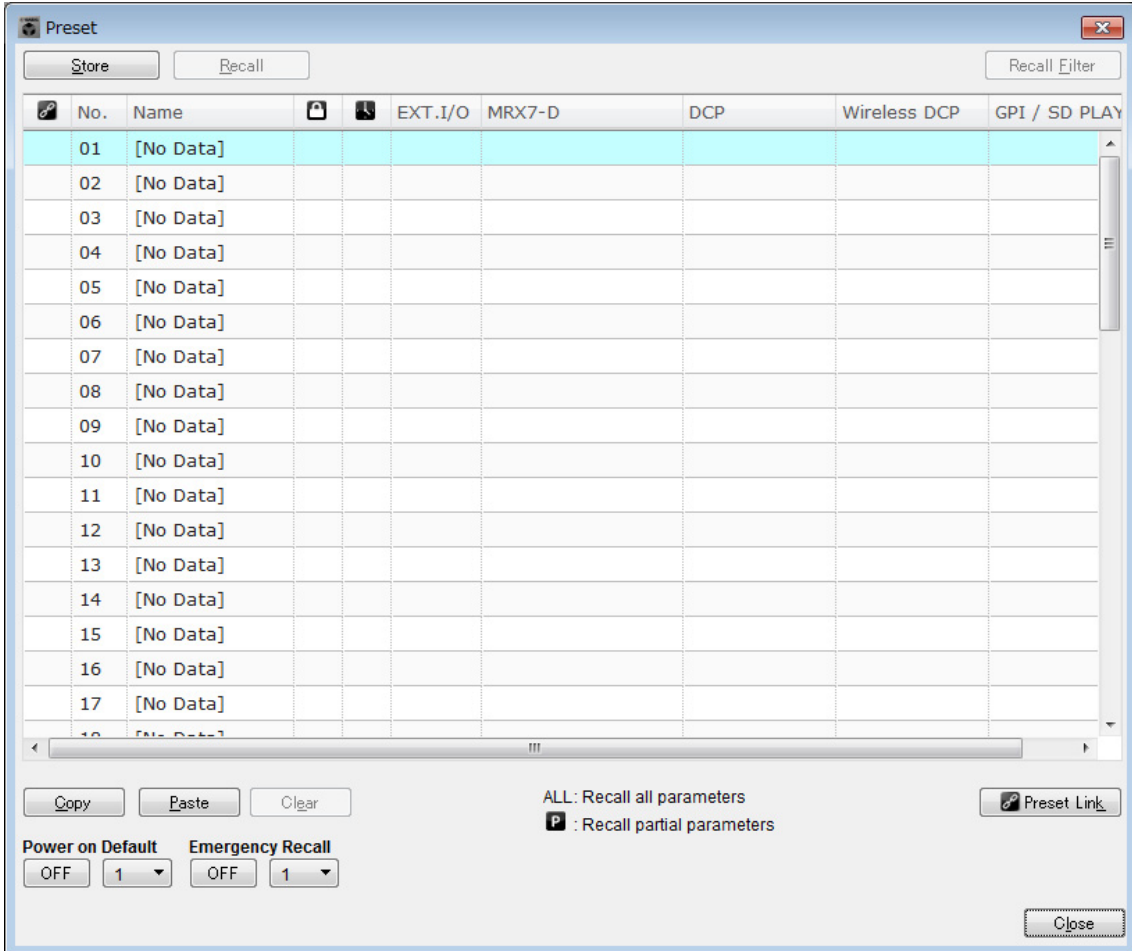

2. Click No. 01 and then click the [Store] button.

The "Store Preset" dialog box will appear.

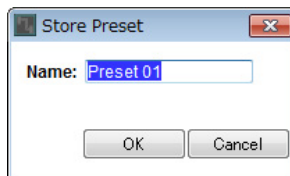

3. Input [Conference] and click the [OK] button.

The current state will be registered as a preset named “Conference.”

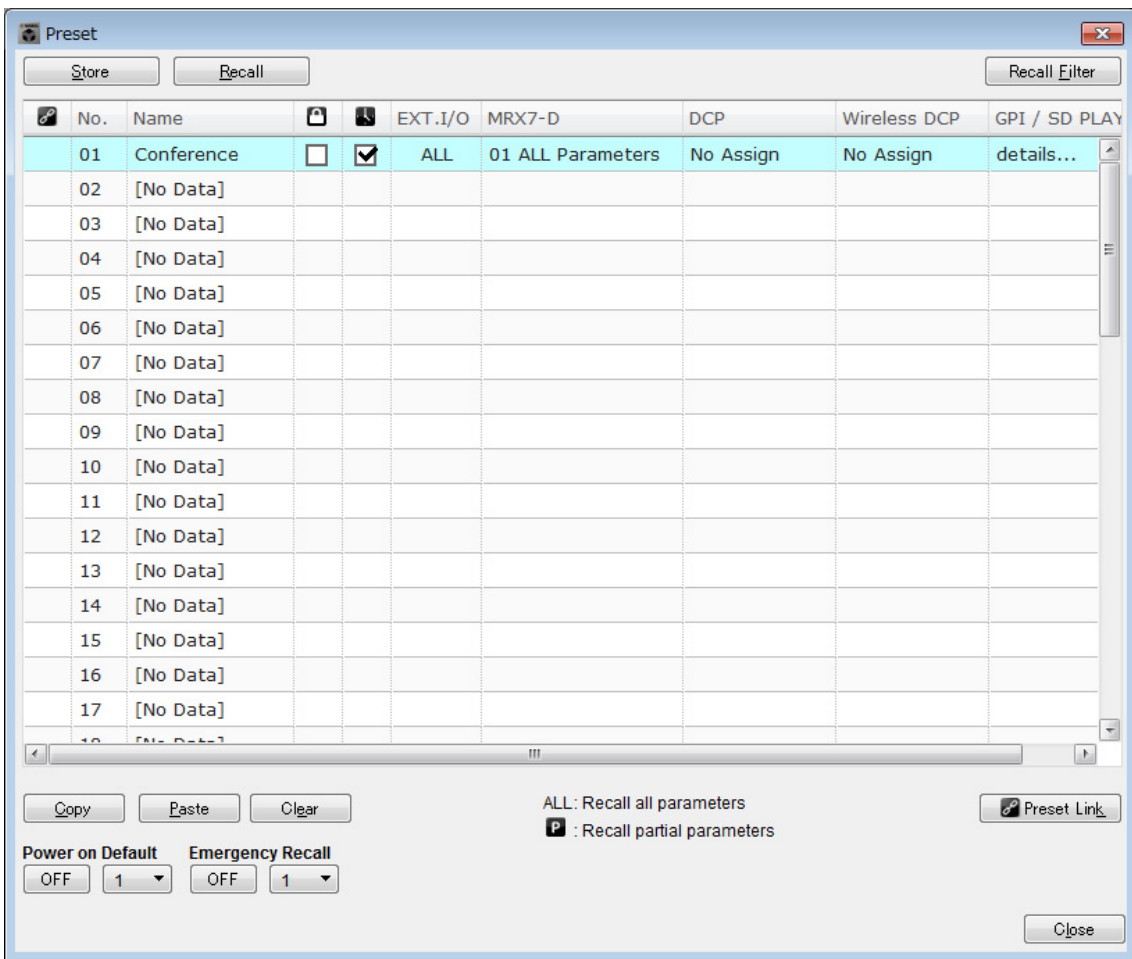

4. Click the [Close] button.

The “Preset” dialog box is closed.

Making EXT. I/O settings

Now we've set the audio output to YDIF channels 1 through 4 of the MRX in MRX Designer. Here, we'll set which XMV channels will receive the audio signals from YDIF channels 1 through 4.

We'll make these settings in the MTX-MRX Editor.

1. Switch to the MTX-MRX Editor display.

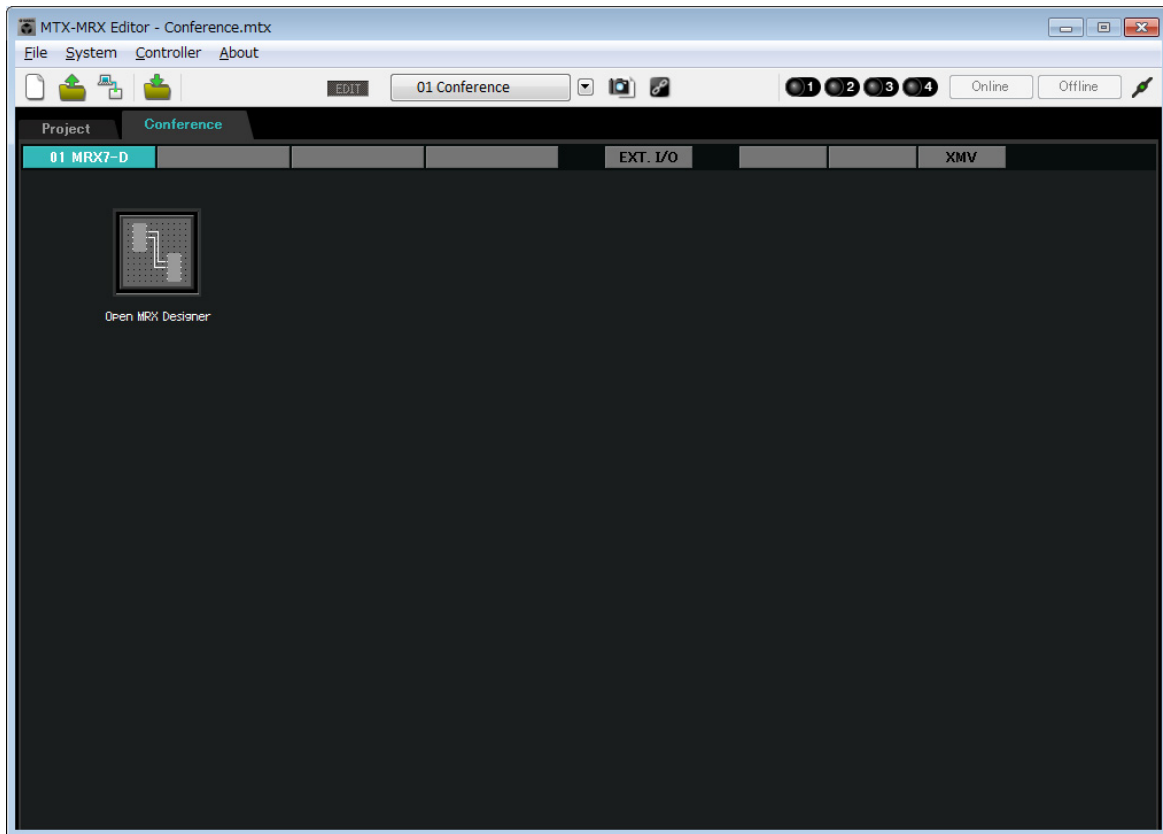

2. Click the [EXT. I/O] button.

The “EXT. I/O” screen will appear.

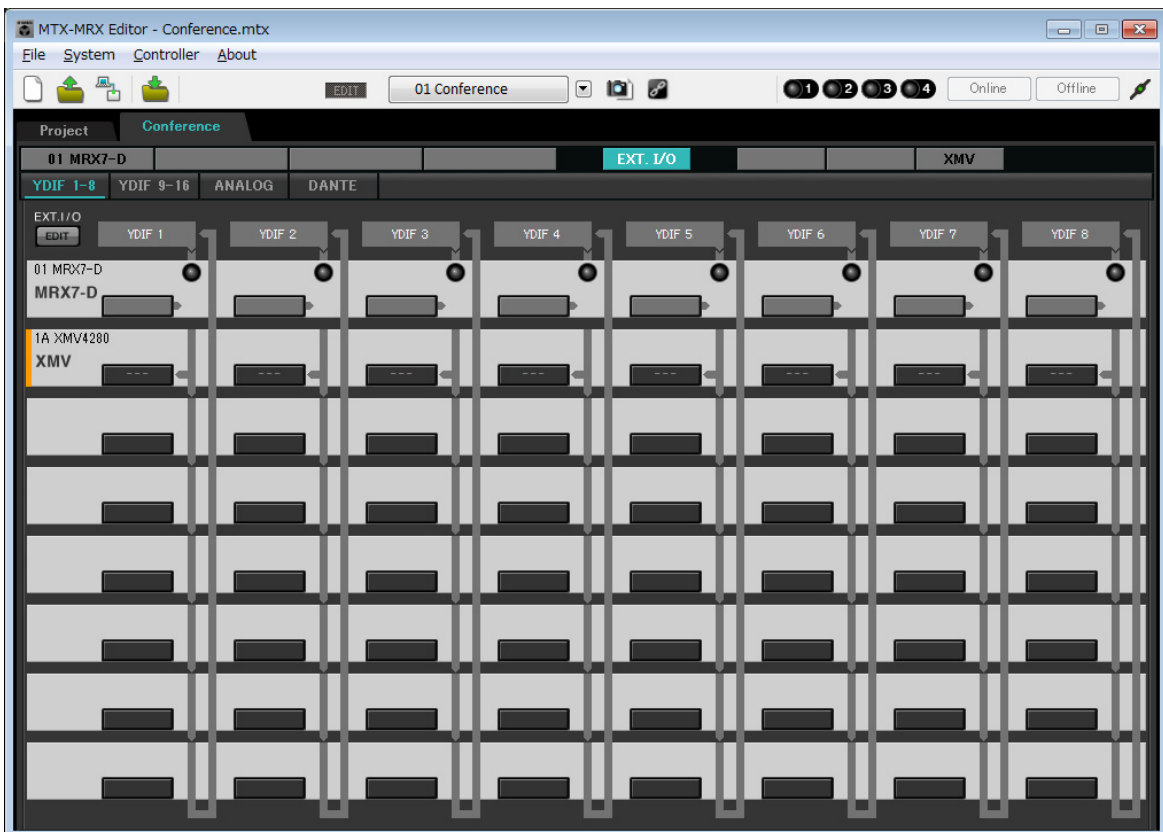

3. Click the [EDIT] button.

Now you can specify the inputs from the XMV unit’s YDIF 1–8.

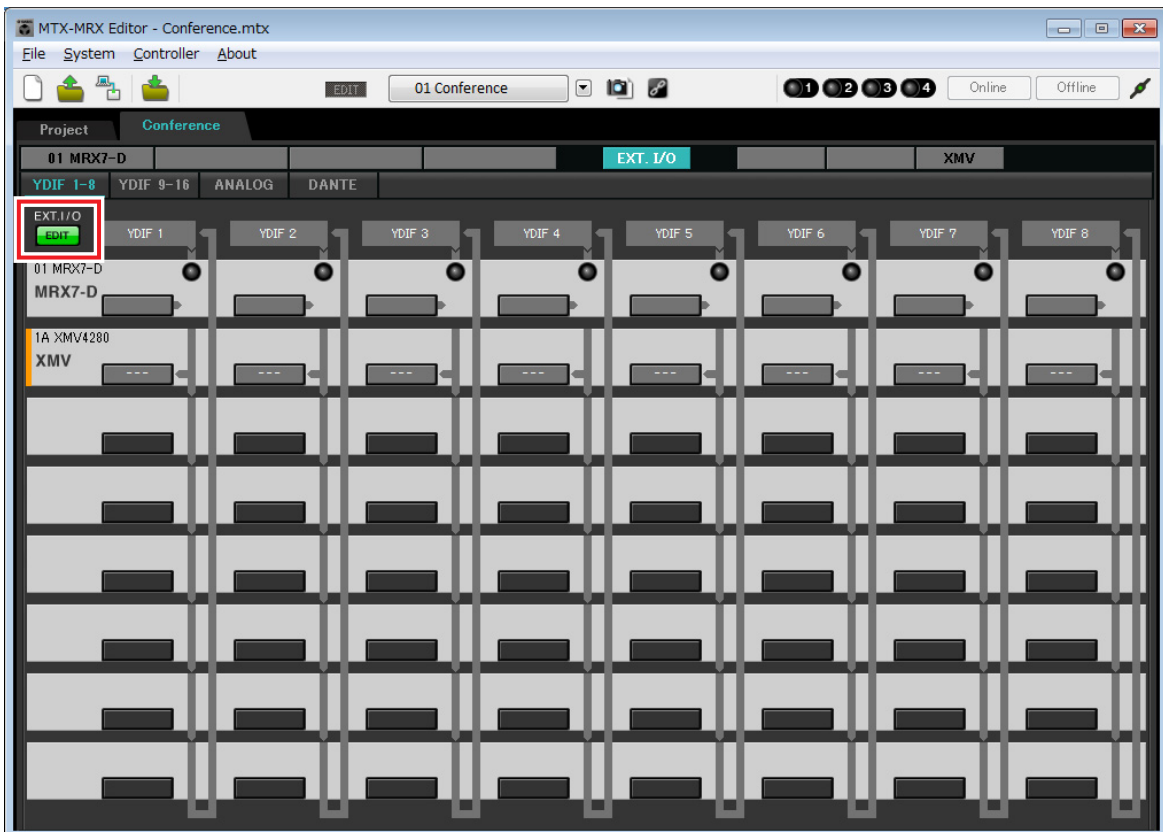

4. Click the XMV's output routing select button for "YDIF 1."

The "YDIF Out Patch" dialog box will appear.

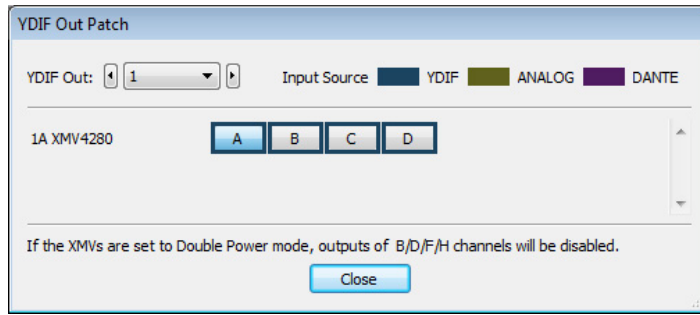

5. For CHANNEL, click [A] button.

Output the YDIF 1 audio signal from the XMV's A channel.

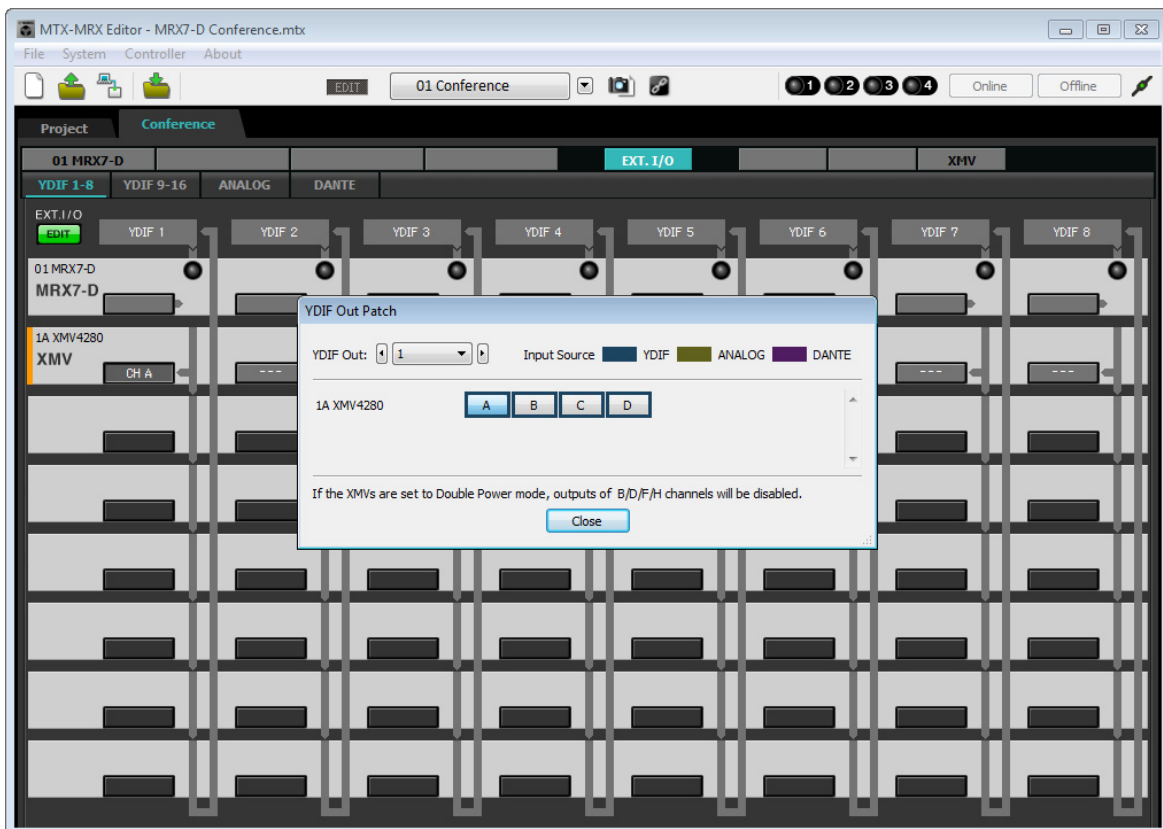

6. Switch to channel 2 using the [YDIF Out:] list box.

The editing target will switch to channel 2.

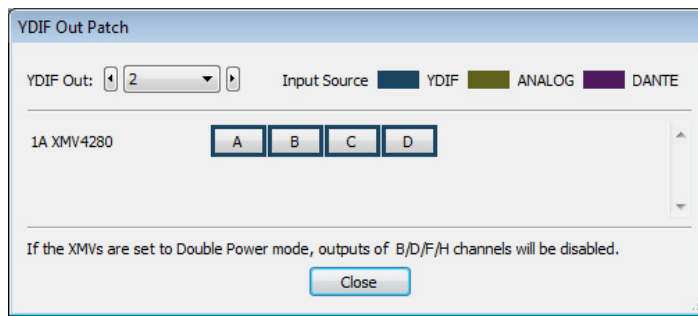

7. Click the [B] button to output the YDIF 2 audio signal from the XMV's B channel.

8. Allocate channels 3/4 to C/D, as shown in steps 6 through 7.

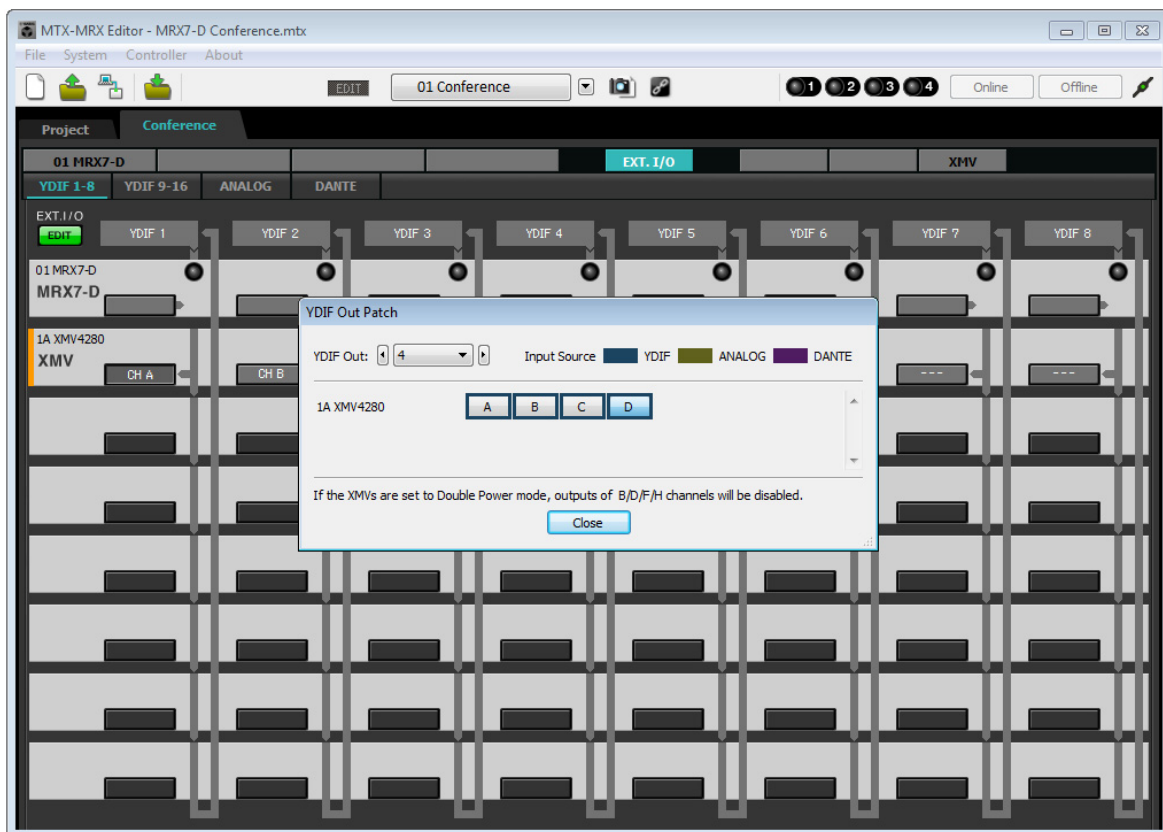

9. Click the [Close] button.

The “YDIF Out Patch” dialog box is closed.

10. Click the [EDIT] button to disable the YDIF output routing select buttons.

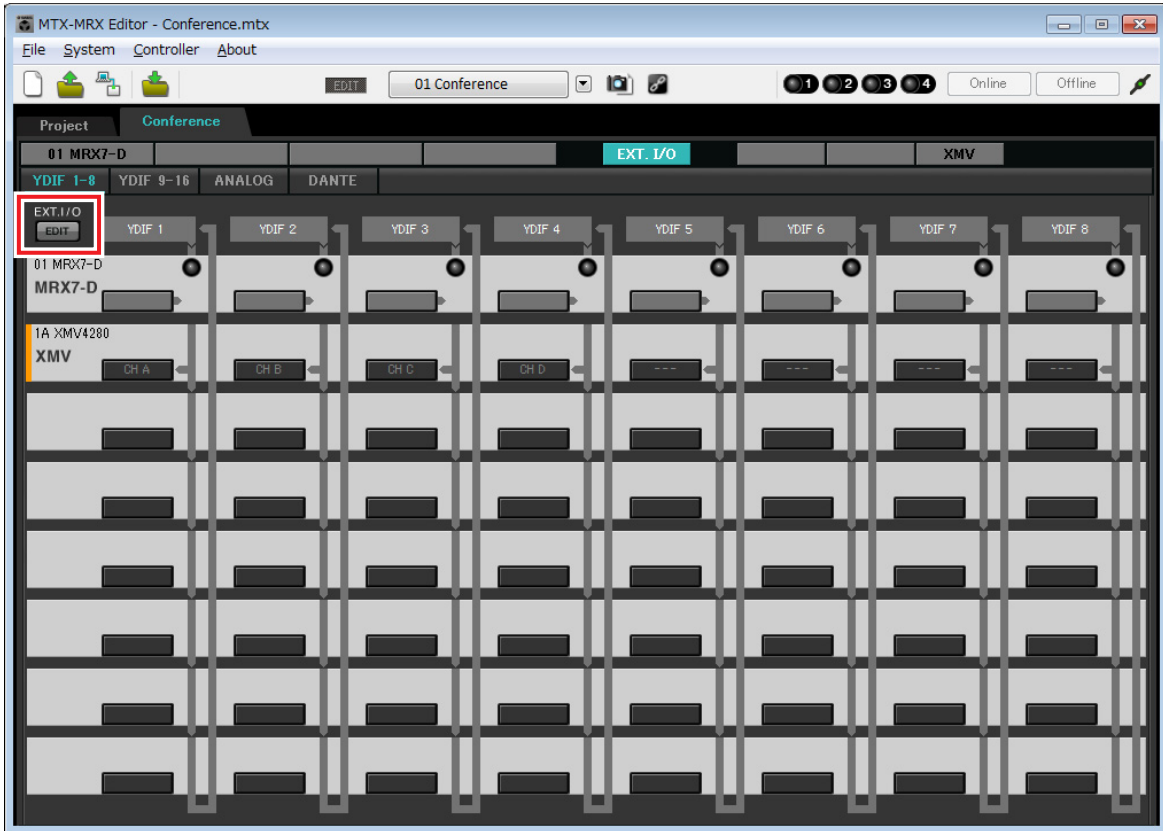

This completes settings in the offline state. Save the settings once again.

Connecting the equipment

After you've rack-mounted the MRX and your other equipment, connect the MRX and the other equipment as shown below. If you've copied audio sources to an SD memory card, insert the card into the MRX now.

XMV4280

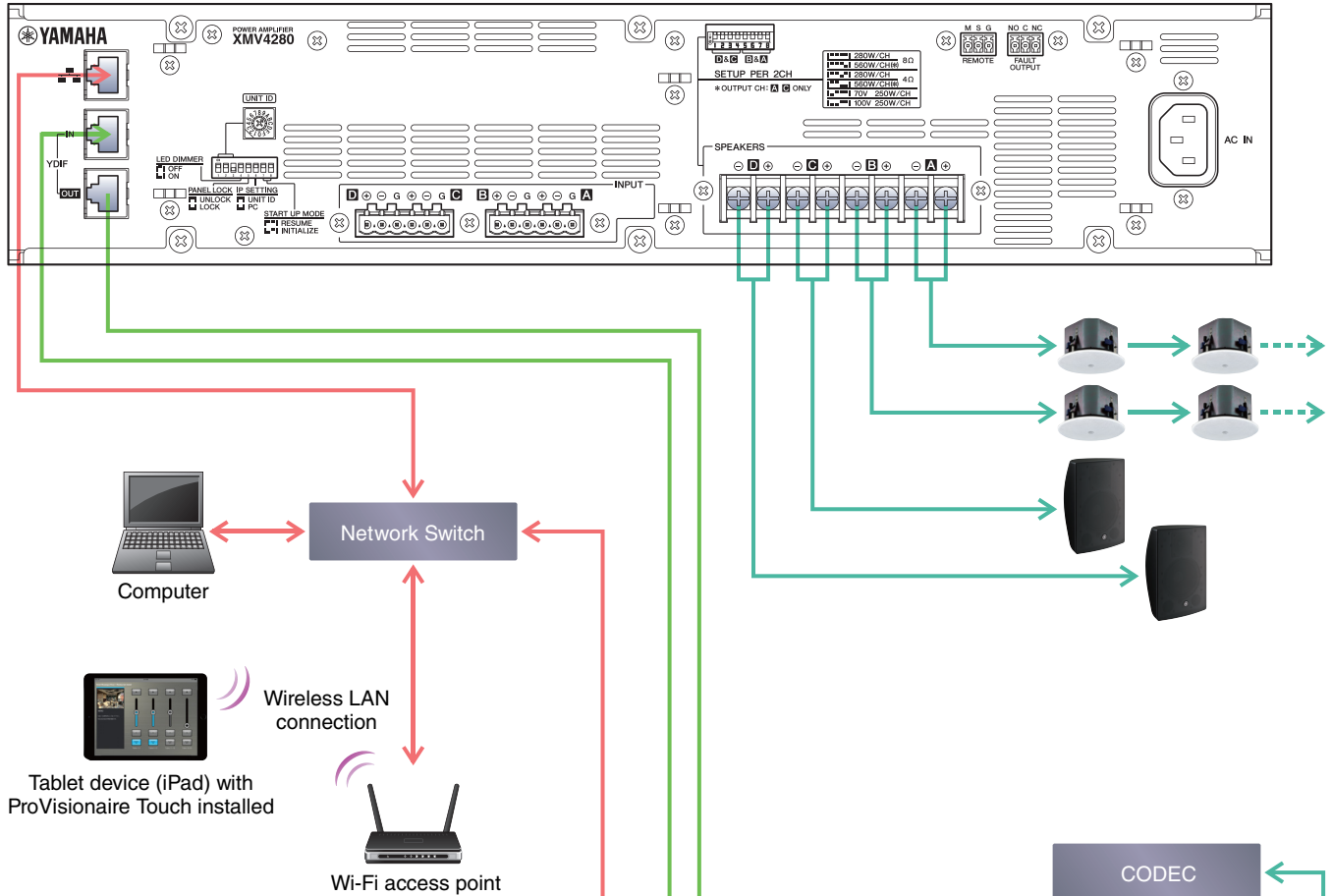

MRX7-D

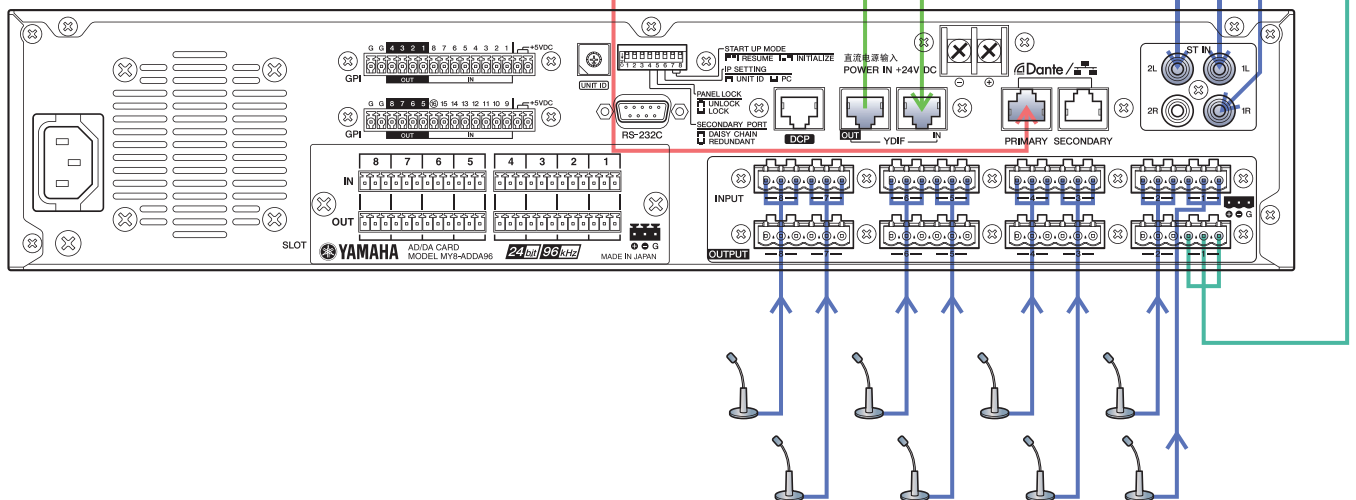

Powering-on the MRX

Turn on the power of the MRX.

Turn off the amplifier before you power-off the MRX.

Powering-on the amp

Turn on the power of the amplifier.

To prevent unwanted sound from being output, we recommend that you turn down the attenuator settings of all channels on the amp itself before you turn it on.

Specifying the computer's TCP/IP address

To allow the MRX and the computer to communicate, specify the computer's TCP/IP as follows.

1. Select [Network Setup] in the [System] menu of the MTX-MRX Editor.
The "Network Setup" dialog box will appear.
2. Click [Open Network Connection].
"Network Connections" will appear.
3. Right-click the adapter to which the MRX is connected, and choose [Properties].
The "Local Area Connection Properties" dialog box will appear.
4. Choose [Internet Protocol Version 4 (TCP/IPv4)], and then click [Properties].
The "Internet Protocol Version 4 (TCP/IPv4) Properties" dialog box will appear.
5. Click [Use the following IP address (S)].
6. In the [IP address] box, enter "192.168.0.253"; in the [Subnet mask] box, enter "255.255.255.0."

NOTE

The IP address of the MRX7-D is set to "192.168.0.1."

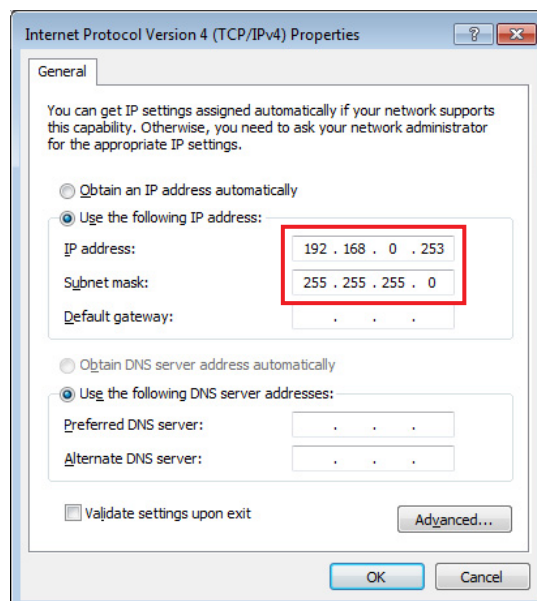

7. Click [OK].

NOTE

In some cases, Windows firewall may block MTX-MRX Editor when you make this setting. Select the [Private Network] check box, and click [Allow Access].

Sending the Speech Privacy environmental sound

Before going online, send the environmental sound to be used for Speech Privacy to the MRX.

1. Start up the MRX Designer.
2. Select [Install Speech Privacy File] from the [File] menu.

The “Install Speech Privacy File” dialog box will appear.

If “Installed” is displayed in the “File” field, the environmental sound has already been installed in the MRX, so there is no need to send it.

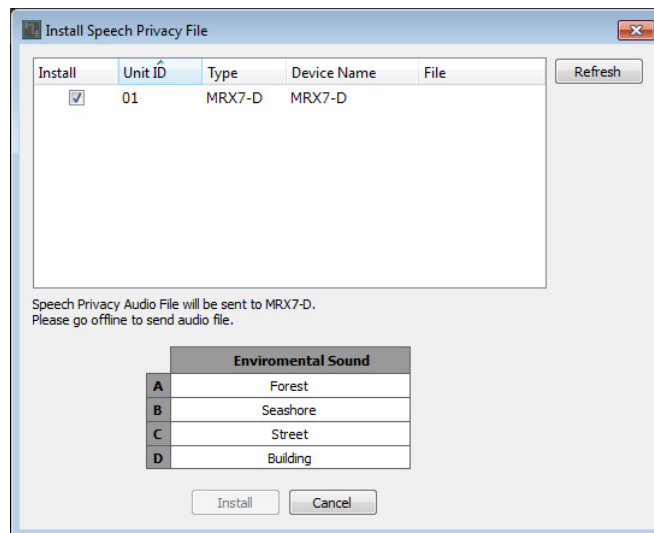

3. Select the checkbox in the “Install” field, and click the [Install] button.

A dialog box will appear, indicating that this may take a while. Click the [Yes] button to continue.

4. When “Complete” is displayed in the “File” field, close the dialog box.

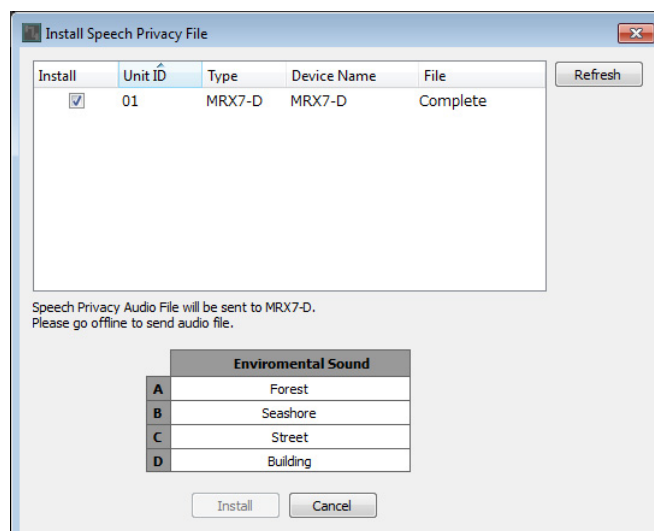

Taking MTX-MRX Editor online

In the upper right of MTX-MRX Editor, click the [Online] button. When the unit has successfully come online, the indicator 1 will light blue.



When the “Synchronization” dialog box appears, select “To Device,” and click the [OK] button. When the indication in the dialog box has switched, select the system that you want to place online, and click the [Online] button.

The project created in MTX-MRX Editor will be sent to the MRX.

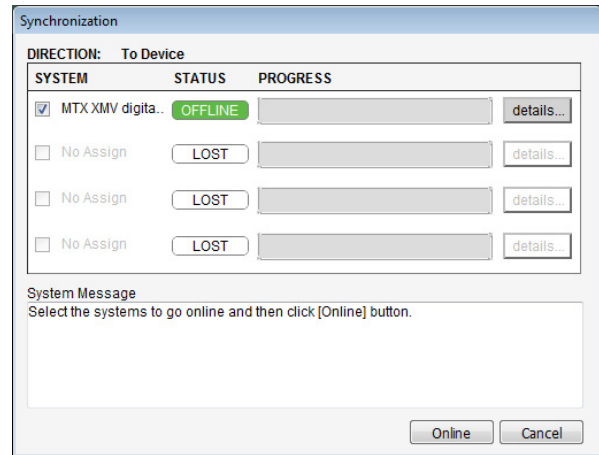
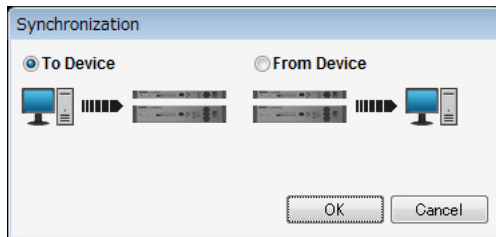

Verifying that the settings were applied

The main items to verify are listed below. For details on each parameter setting, refer to “MTX-MRX Editor User Guide” and “MRX Designer User Guide.”

1. Input an audio signal such as AUX IN to the inputs of the MRX7-D, and adjust the input levels.

Adjust the AUX IN input levels using “Fader(2).” You can use ProVisionaire Touch to adjust the level of sound coming from the room speakers.

2. Adjust the Speech Privacy output level using “Fader(7).”

3. Adjust the input level of the mic using the “ANALOG IN” editor.

Turn the [+48V] button on as necessary.

NOTICE

Be sure to leave this button off if you do not need phantom power.

Follow the important precautions below, in order to prevent noise and possible damage to external devices as well as the unit when you operate this switch.

- Be sure to leave this button off when you connect a device that does not support phantom power to [INPUT] connector.
- Do not connect/disconnect a cable to/from [INPUT] connector while this button is on.
- Down the output level to the minimum before operating this button.

NOTE

There is no master switch. To avoid malfunctions, be sure to set this appropriately for the equipment that is connected.

4. Adjust the other inputs and outputs.

5. Confirm the settings on the ProVisionaire Touch.

Check whether the ProVisionaire Touch is operating according to the settings.

When you have finished making all settings, save the project and switch MTX-MRX Editor offline.

This completes the settings for example 2.

Example 3) A paging system using the PGM1

Place the “Paging” components, and assign broadcast destinations (zones, zone groups) or pre-recorded messages to the zone/message select buttons of the PGM1 units.

You can use the buttons to select the broadcast destination (multiple selections are allowed) and play back pre-recorded messages from the SD card.

On the SD card that you’ll insert into the MRX, save the audio files for the Opening Chime, Closing Chime, and messages.

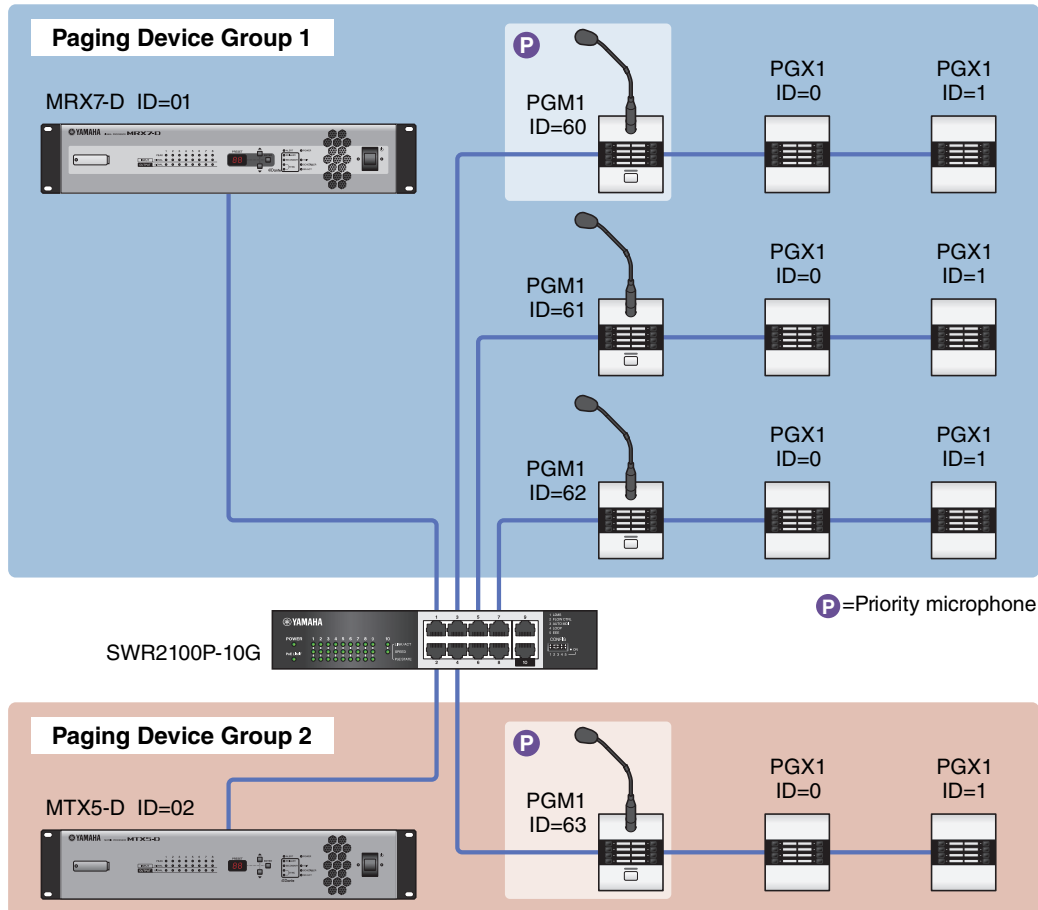

Up to four PGM1 units can be connected to an MTX/MRX system that includes an MRX. One PGM1 unit can control one MRX, and this PGM1 together with the MRX are collectively called a Paging Device Group. One of the PGM1 units within the Paging Device Group is the 1st Priority Mic; this unit can broadcast taking priority over the other PGM1 units. There are three ways to use the PGM1.

■ Broadcast from the mic.

1. Use the zone/message select buttons to select the broadcast area.

2. Press the PTT button.

If specified, the Opening Chime is heard.

3. When the status indicator is lit red, speak into the mic.

4. When you finish speaking, press the PTT button.

If specified, the Closing Chime is heard.

■ Play back a pre-recorded message from SD card

1. Use the zone/message select buttons to select the broadcast area.
2. Use the zone/message select buttons to select the message that you want to play back.
3. Press the PTT button.

If specified, the Opening Chime is heard.

The message plays, and the status indicator is lit red.

When message playback is completed, PTT automatically turns off.

If specified, the Closing Chime is heard.

■ Use the scheduler to play back a pre-recorded message from SD card

By issuing a Paging event, the specified message is played back to the specified zone or zone group.

Using the Device Configuration Wizard to create your device setup

Before you specify the internal configuration of the MRX, use MTX-MRX Editor's wizard to create the device configuration.

After you've made basic settings, you'll be able to print information about the cabling and ID numbers.

Use the following procedure to make basic settings.

1. Type a name for the MTX/MRX system you'll be constructing, and click [Next>].

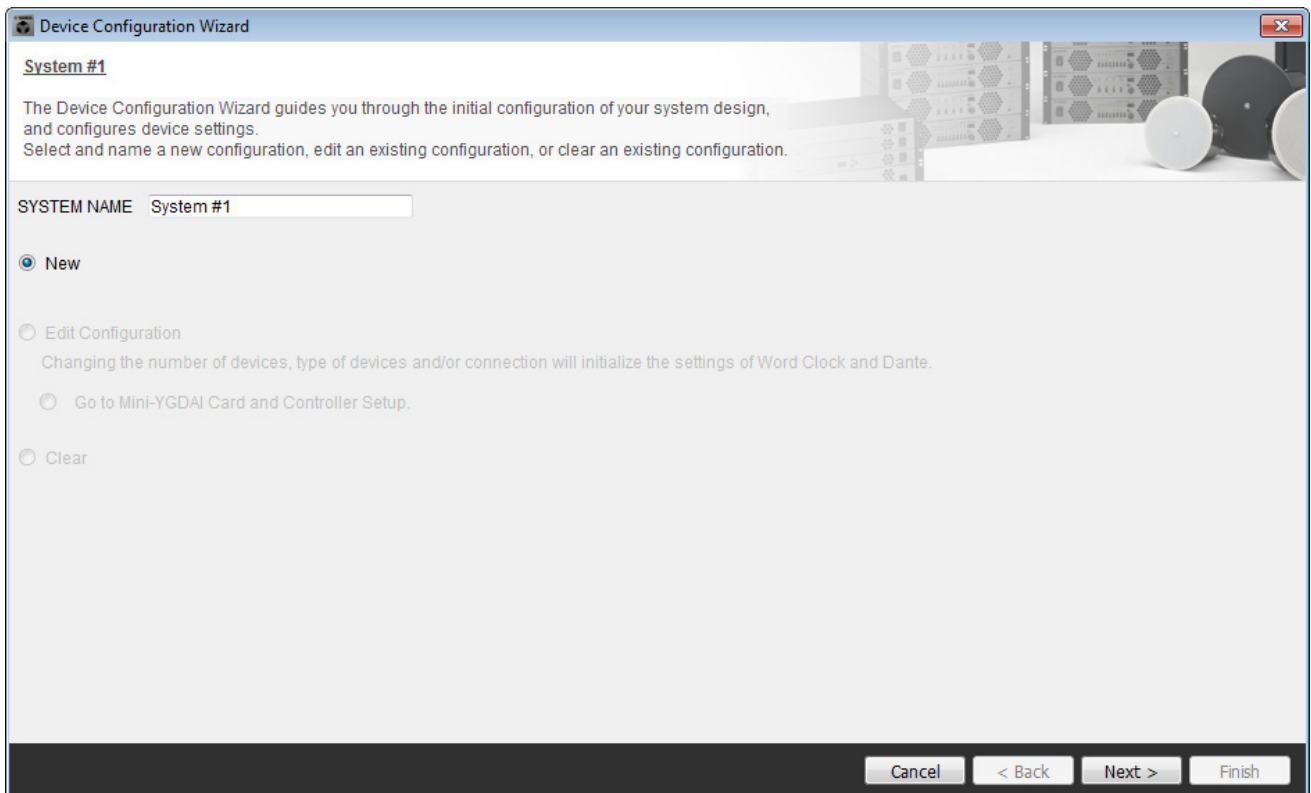

2. Specify the number of units that will be connected in your MTX/MRX system, and click [Next>].

Set the number of “YDIF Connected” MRX7-D units to 1, the number of EXi8 units to 1, the number of “DANTE Connected” PGM1 units to 1, the number of XMV8280-D units to 1, and in the far right row set the number of MCP1 units to 3.

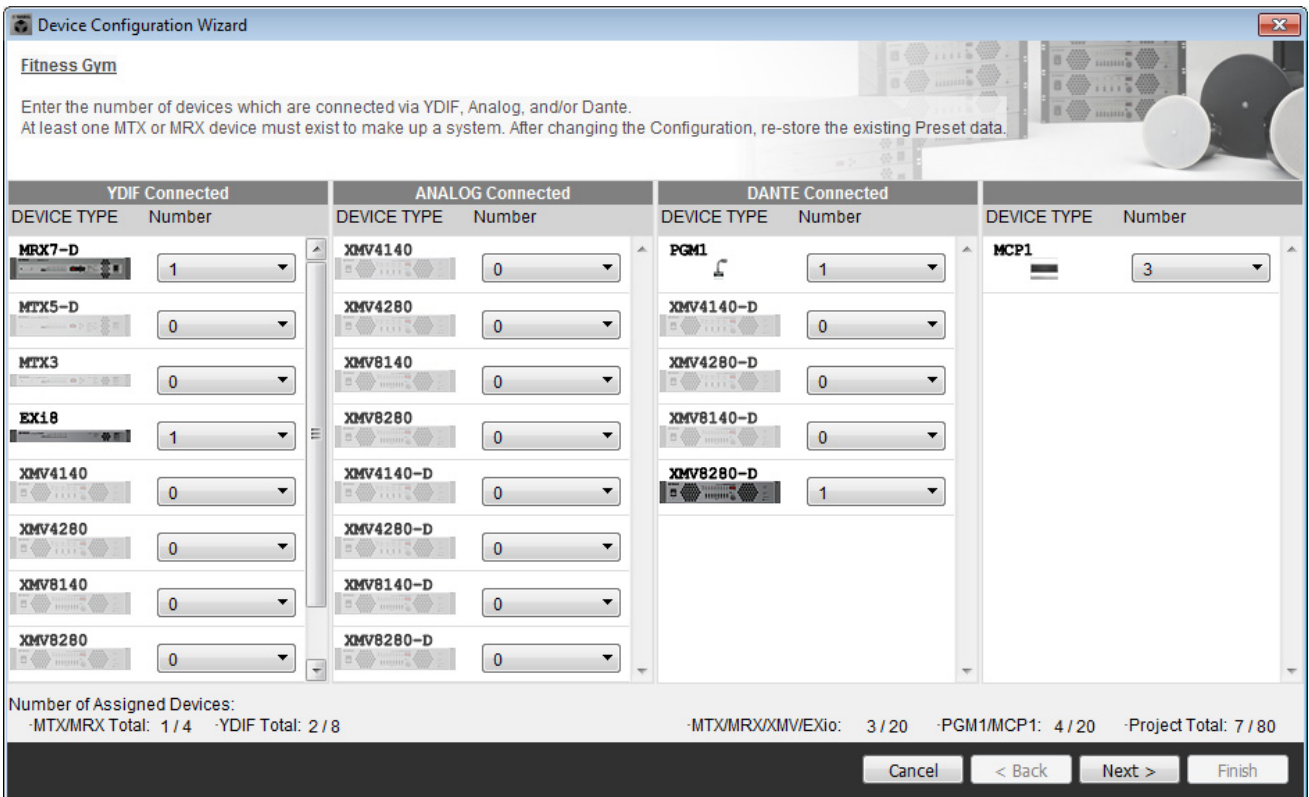

3. Specify the UNIT ID of each device, and click [Next>].

Unless you have specific reasons for doing otherwise, use the UNIT ID that is assigned.

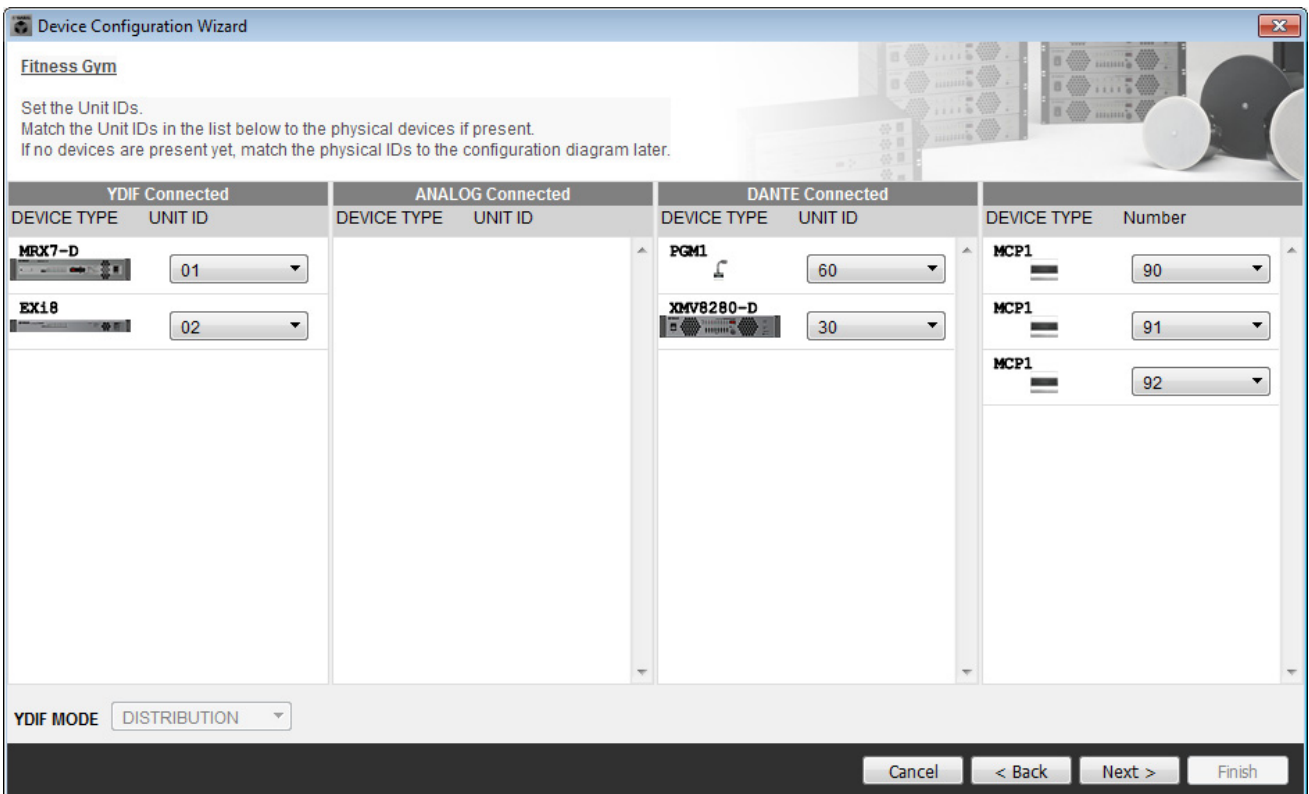

4. Set the [UNIT ID] rotary switch and DIP switch of the devices.

Set the computer's IP address after completing the wizard, in "Specifying the computer's TCP/IP address."
 If the device is not nearby, you can set it during the step "Connecting the equipment."
 You'll set the MCP1's UNIT ID during the step "Connecting the equipment."

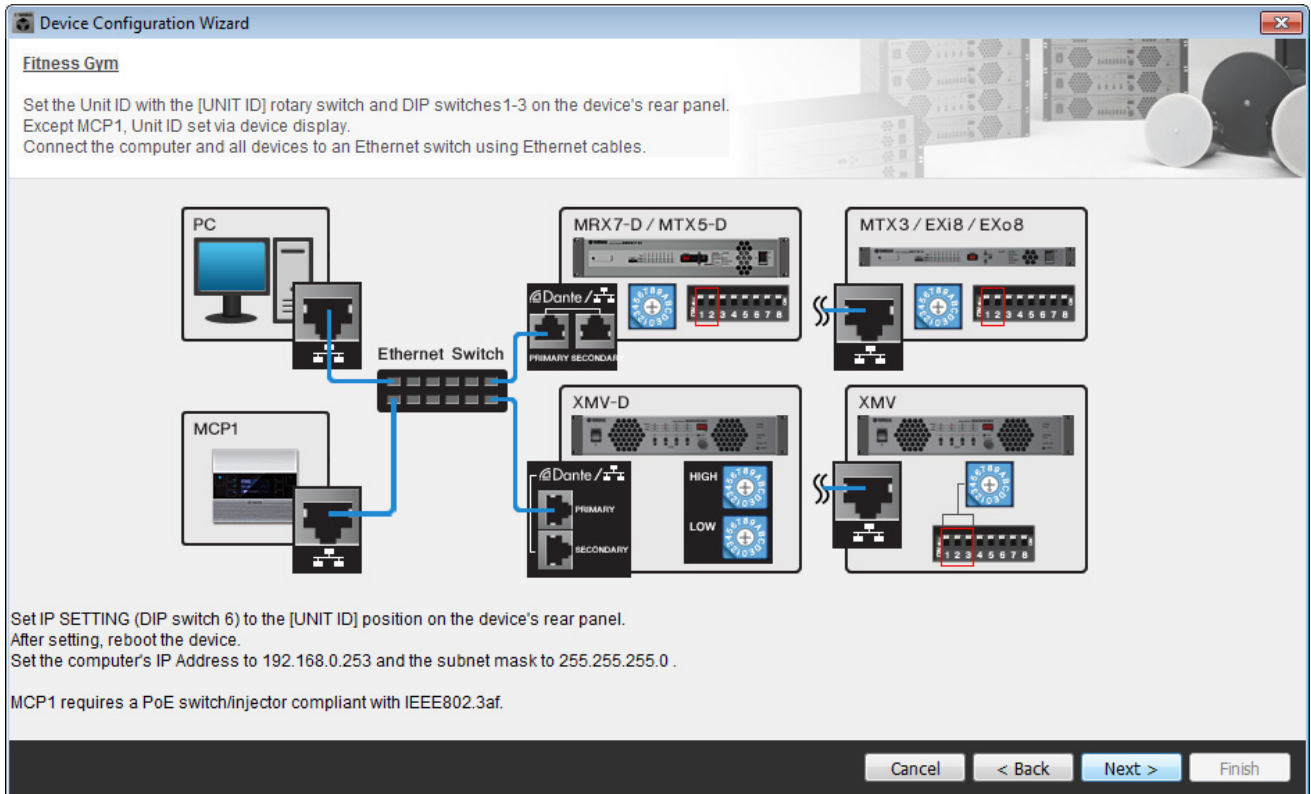

Make the following settings. The method of setting the PGM1's UNIT ID is explained in step 8.

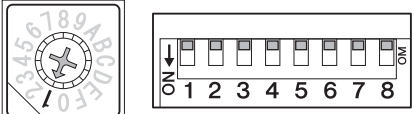
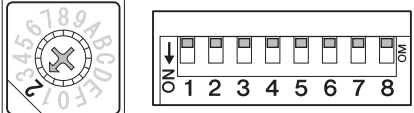
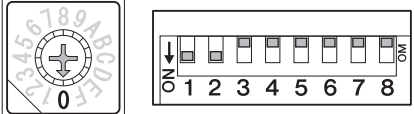
<p>EXi8</p> 	<p>UNIT ID = 01 [UNIT ID] rotary switch = 1 DIP switches = all OFF (upward)</p>
<p>MRX7-D</p> 	<p>UNIT ID = 02 [UNIT ID] rotary switch = 2 DIP switches = all OFF (upward)</p>
<p>XMV</p> 	<p>UNIT ID = 30 [UNIT ID] rotary switch = 0 DIP switch = 1 and 2 are ON (downward), others are OFF (upward)</p>

5. When you've finished setting the device's [UNIT ID] rotary switch and DIP switch, click [Next>].

6. Verify that the devices are shown in the screen, and click [Next>].

Do not change the order.

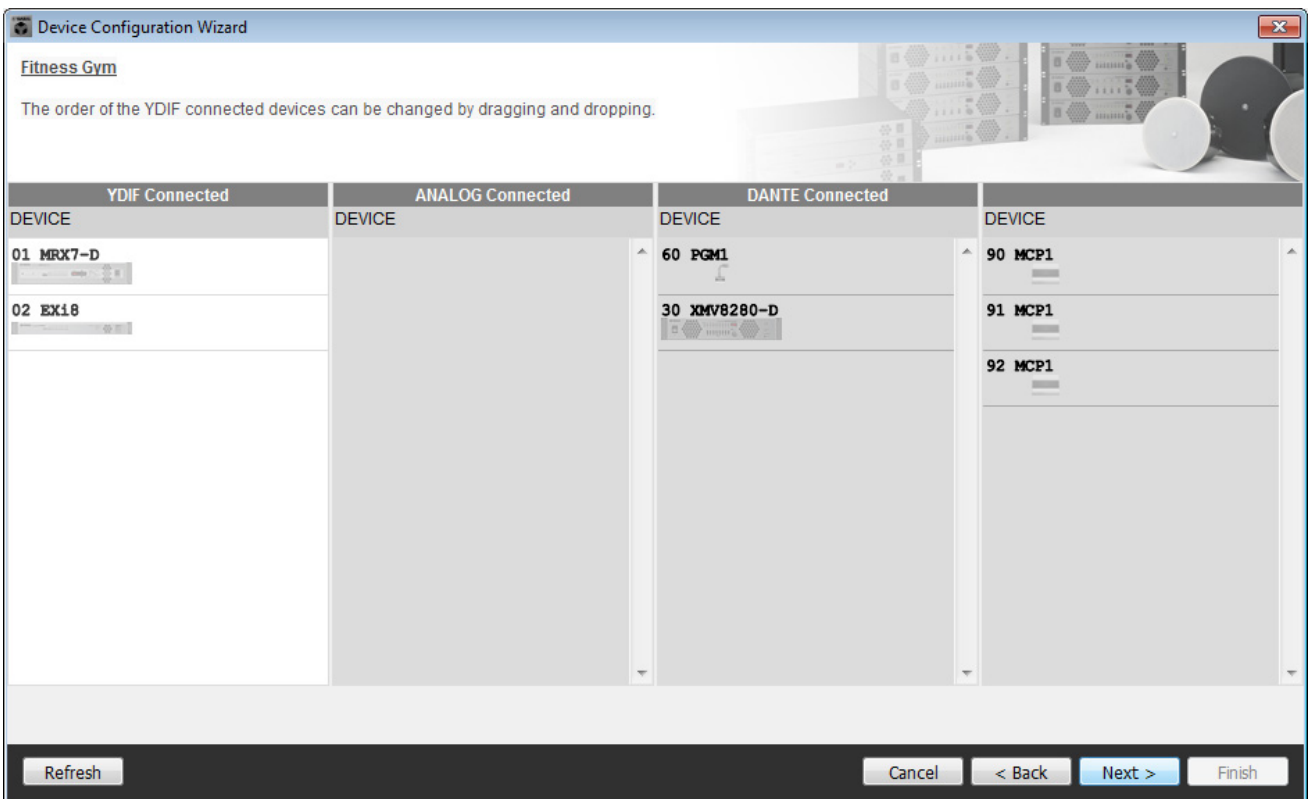

7. Set the number of PGX1 units to 1.

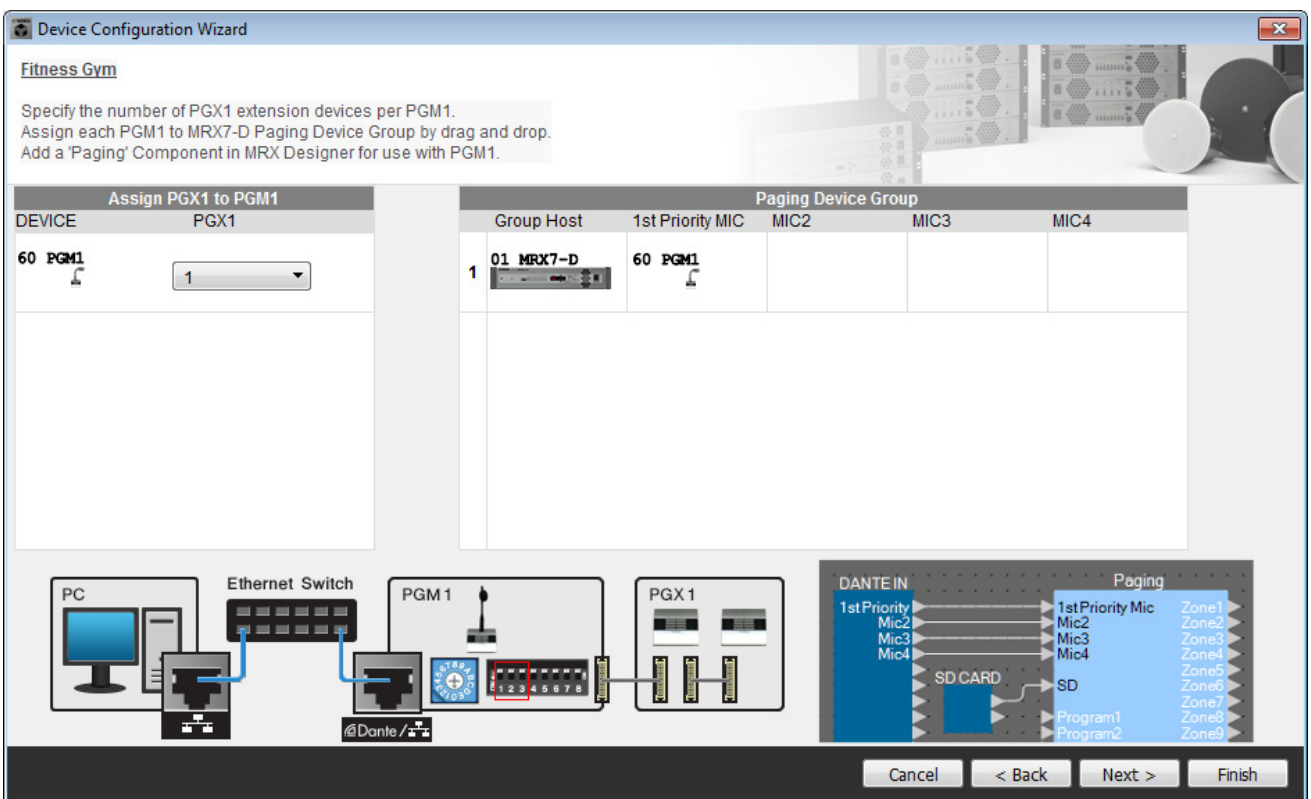

8. Set the PGM1's [UNIT ID] rotary switch and DIP switch.

If the device is not nearby, you can set it during the step "Connecting the equipment."
 Make the following settings.

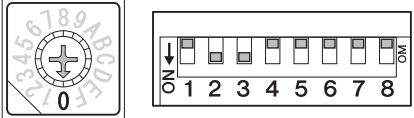
<p>PGM1</p> 	<p>UNIT ID = 60 [UNIT ID] rotary switch = 0 DIP switch = 2 and 3 are ON (downward), others are OFF (upward)</p>
--	---

9. When you've finished setting the PGM1's [UNIT ID] rotary switch and DIP switch, click [Next>].

10. Click [Next>].

For the MRX, use MRX Designer to select the Mini-YGDAI card.

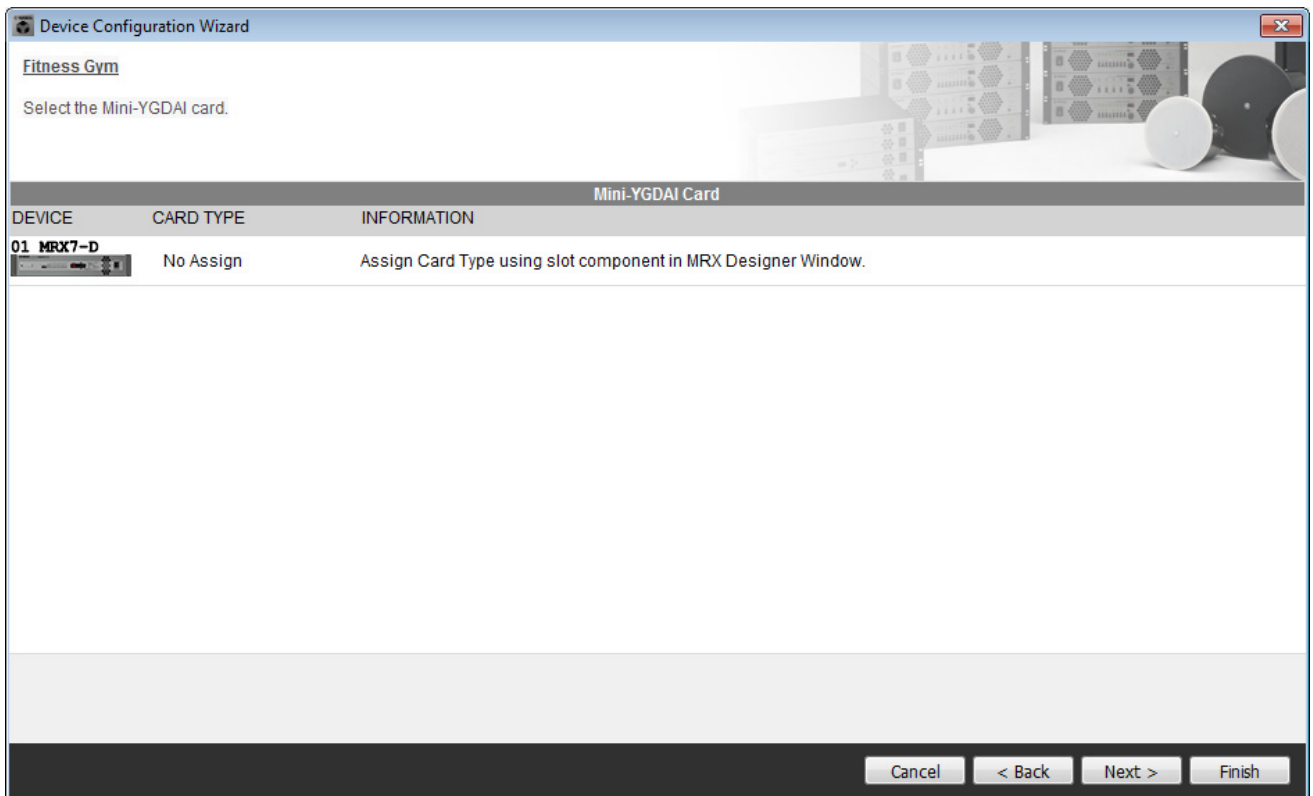

11. Choose the model of DCP that will be connected to the MRX, enter a device name, and click [Finish].

In this example, specify seven DCP1V4S units.

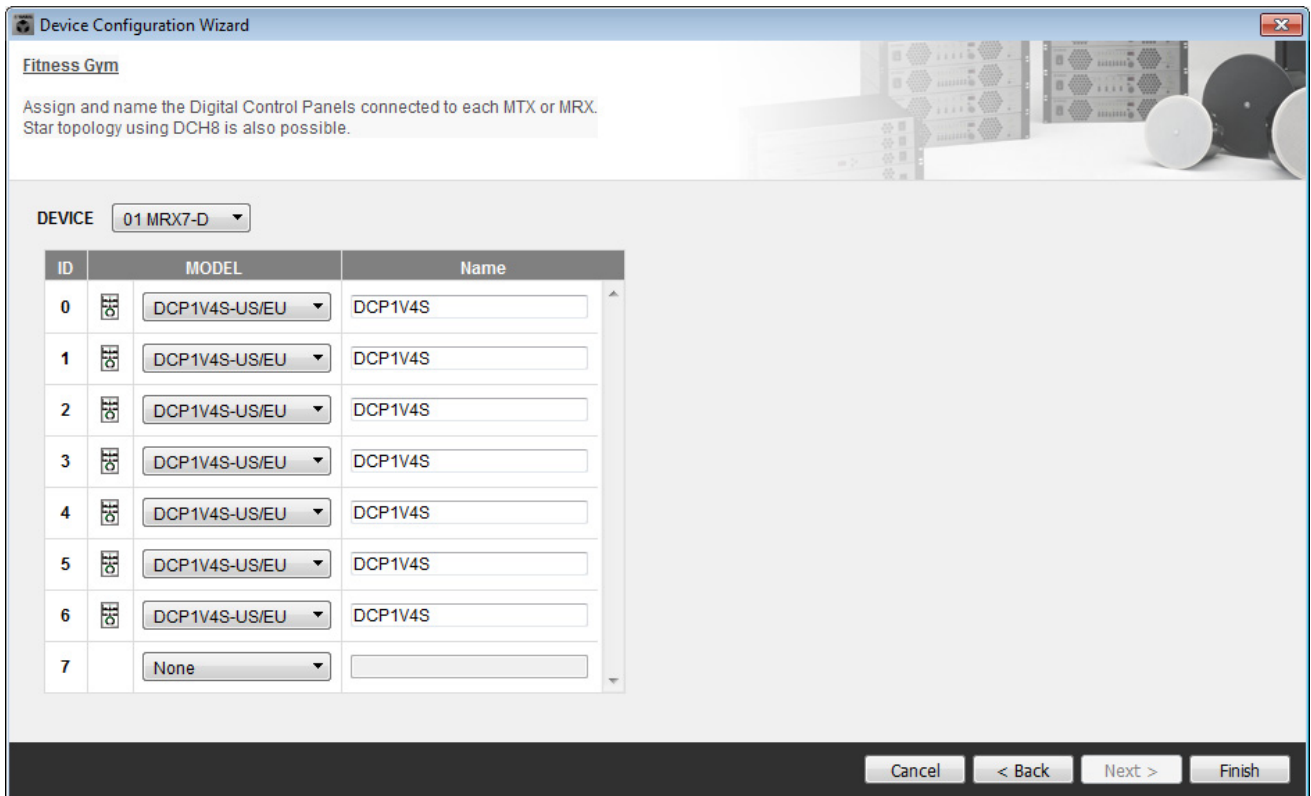

12. When you see the dialog box “Display the configuration diagram? The diagram can also be printed.” click [Yes].

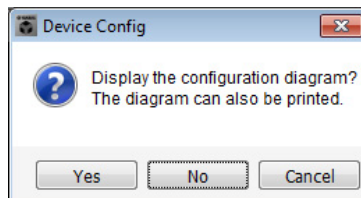

A cabling diagram will appear. If you want, click [Print] to print the diagram.
 You can click the [>>Page2]/[>>Page1] buttons to switch pages.
 To close the screen, click [Close].

Page 1

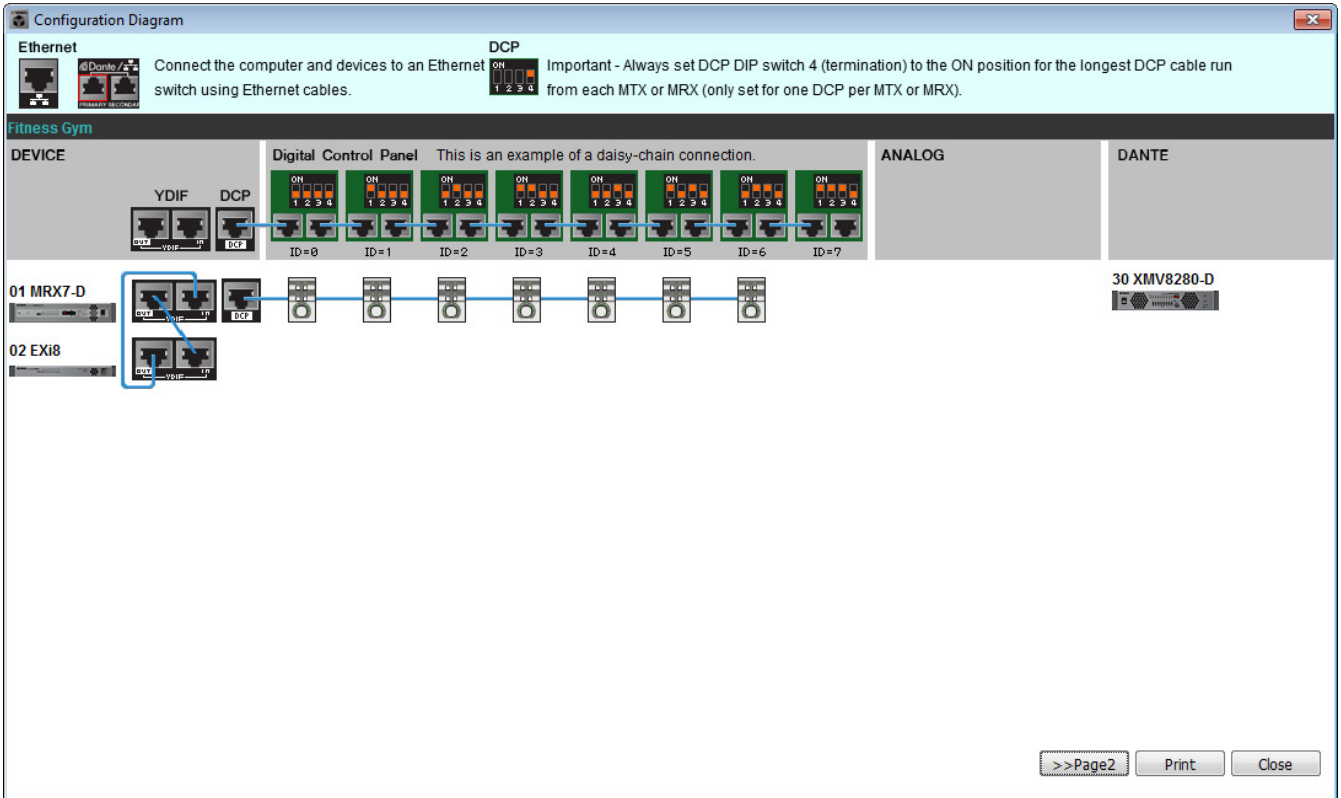

Page 2

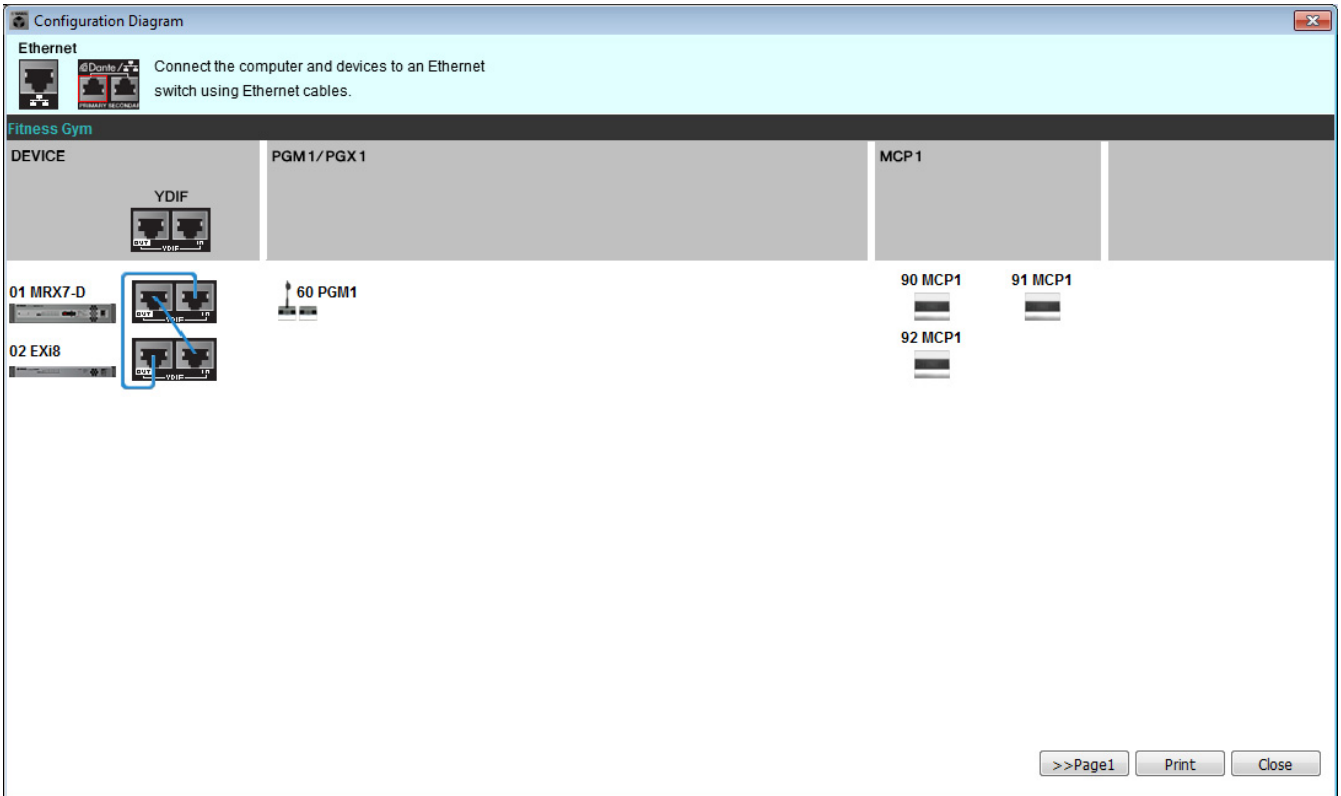

Set the DIP switches of the DCP units as directed in “Digital Control Panel” of the cabling diagram.
For the last DCP (ID=6), set DIP switch 4 upward.



NOTE

If you want to view the cabling diagram again, choose [File] menu → [Print Configuration Diagram].

If you want to use the Device Configuration Wizard to change the device configuration, click the [Device Config] button in the Project screen.

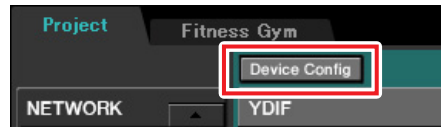

Specifying the MRX configuration

Placing and connecting the components

Use MRX Designer to specify the internal configuration of the MRX.
When you’ve finished making settings, you should save them by clicking [File] menu, then [Save].

NOTE

The “User Account Control” dialog box may appear. Click [Continue] or [Yes].

■ Starting MRX Designer

Move to the setting screen by clicking the tab of the system name you specified in step 1 of “Using the Device Configuration Wizard to create your device setup.”

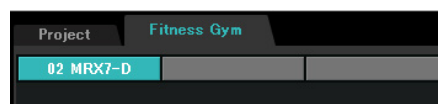

After you’ve moved to this screen, click the “Open MRX Designer” button to start MRX Designer.

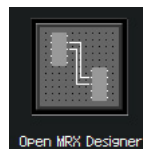

■ Placing the input components

Here you'll place the input components that you will use.

From the “Components” area, drag and drop the following components onto the design sheet.

- “DANTE IN 1–16”
- “SD CARD”
- “ANALOG IN”
- “STEREO IN”
- “YDIF IN”

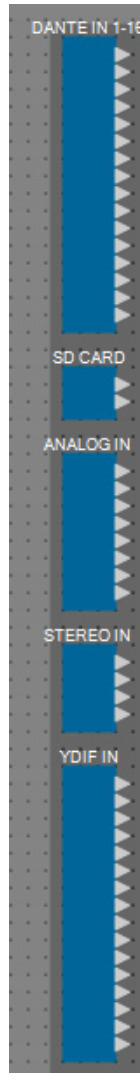

■ Showing port names for the input components

To avoid subsequent confusion when connecting the cabling, use the “Port Name” dialog box to enter the port names. To access the “Port Name” dialog box, click the button located at the right of the [Label] editing area in the “Properties” area.

For “ANALOG IN,” you can also enter the port name using the “ANALOG IN” component editor that appears when you double-click the component.

In this example, enter the port names as follows.

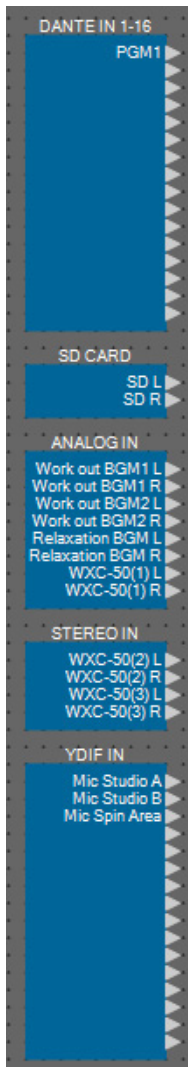

DANTE IN 1–16	1	PGM1
SD CARD	1L	SD L
	1R	SD R
ANALOG IN	1	Work out BGM1 L
	2	Work out BGM1 R
	3	Work out BGM2 L
	4	Work out BGM2 R
	5	Relaxation BGM L
	6	Relaxation BGM R
	7	WXC-50(1) L
	8	WXC-50(1) R
STEREO IN	1L	WXC-50(2) L
	1R	WXC-50(2) R
	2L	WXC-50(3) L
	2R	WXC-50(3) R
YDIF IN	1	Mic Studio A
	2	Mic Studio B
	3	Mic Spin Area

■ Placing and cabling the PGM1-related components in Reception

Here we will place and cable the components related to the PGM1 in Reception.

1. From the “Components” area, drag and drop the following components onto the design sheet.

- “Matrix Mixer” (2In/2Out)
- “Paging”

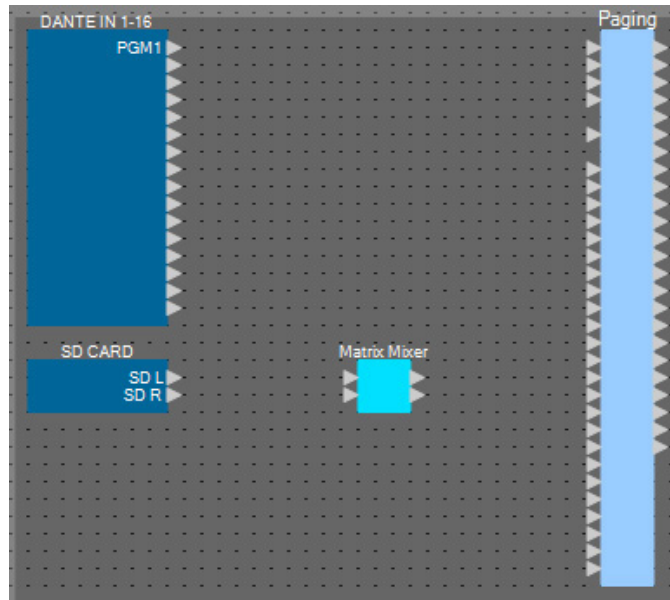

2. On the [Tools] menu, click [Duplicate Port Label].

This causes the port name to be carried over when you make the connection.

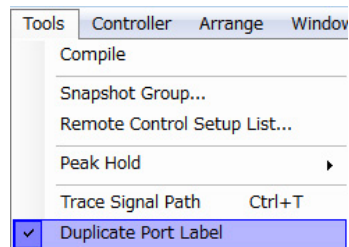

3. Drag and drop to connect port 1 of “DANTE IN 1–16” to the 1st Priority Mic port of “Paging.”

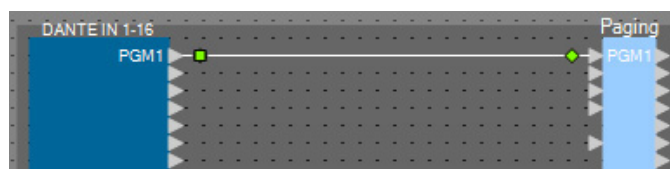

4. Drag and drop to connect the “SD CARD” ports with the input ports of the “Matrix Mixer,” and drag and drop to connect output port 1 of the “Matrix Mixer” to the SD port of “Paging.”

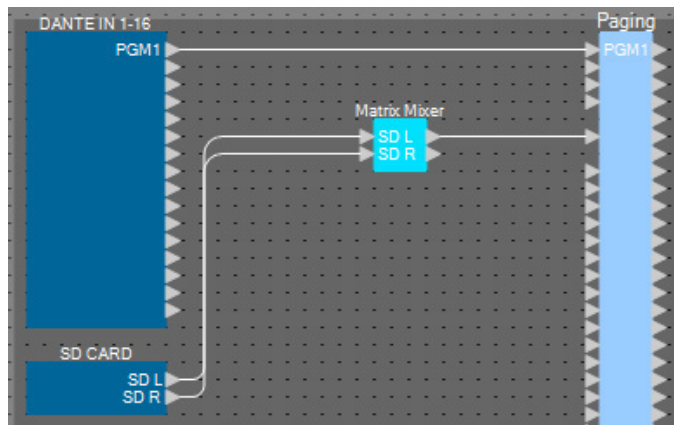

5. Double-click the “Matrix Mixer.”

The “Matrix Mixer” component editor opens.



6. Make settings so that Input 1 and 2 are output to Output 1, enter “SD” for Output 1, and then click the [x] button in the upper right to close the component editor.



■ Placing and connecting the components related to BGM (monaural) input

Here we place and connect the components related to the input of the background music (monaural) that is broadcast to the facility.

1. From the “Components” area, drag and drop the following components onto the design sheet.

- “Matrix Mixer” (8In/4Out)
- “Source Selector” (4Source/1Ch)
- “Fader” (8Ch)

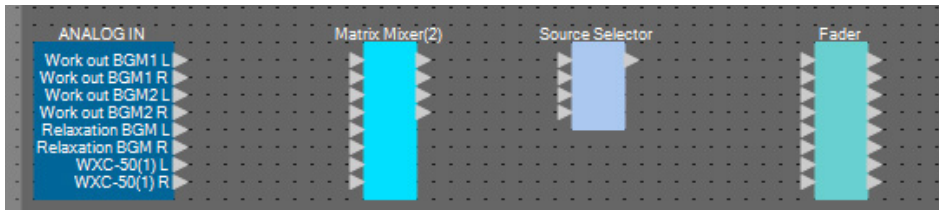

2. Drag and drop to connect “ANALOG IN” ports 1 through 6 to “Matrix Mixer(2)” input ports 1 through 6.



3. Double-click “Matrix Mixer(2).”

The “Matrix Mixer” component editor opens.

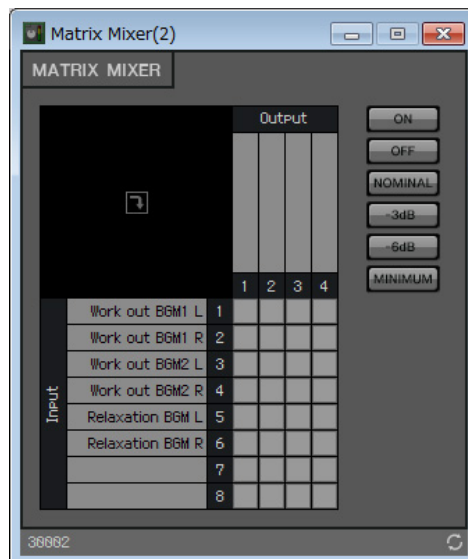

4. Make settings so that Input 1 and 2 are sent to Output 1, Input 3 and 4 to Output 2, and Input 5 and 6 to Output 3.

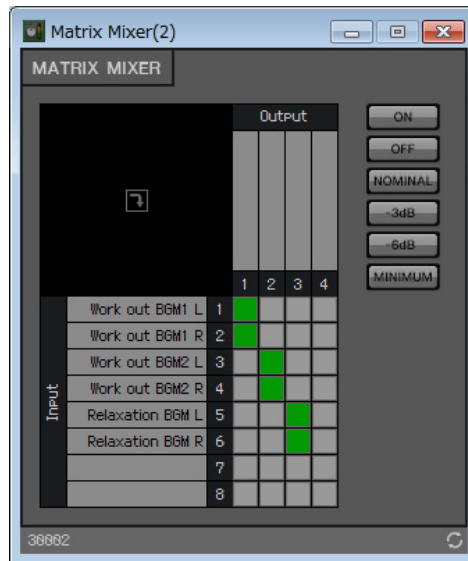

5. Enter “Work out BGM1” for Output 1, enter “Work out BGM2” for Output 2, and enter “Relaxation BGM” for Output 3; then click the [x] button in the upper right to close the component editor.

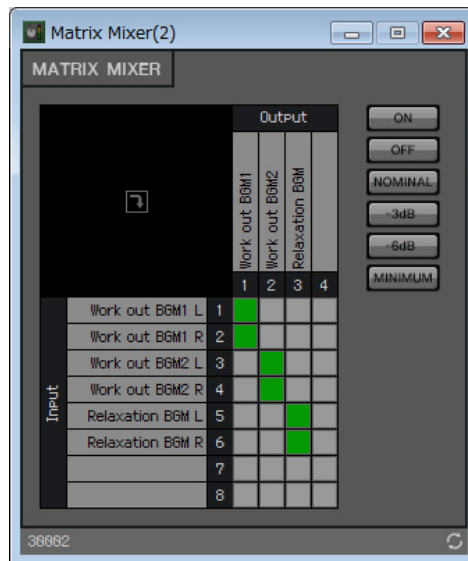

6. Click “Source Selector” to select it.

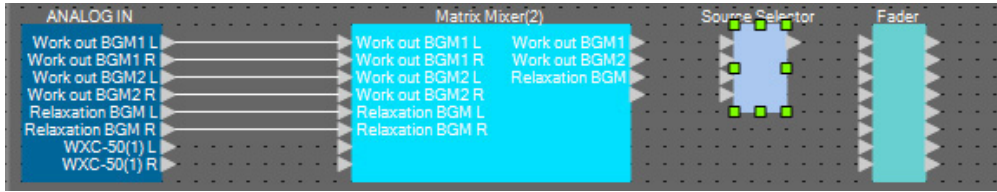

7. Copy the selected component, and paste it six times. Alternatively, drag and drop the selected component while holding down <Ctrl>.

Change the location of the components as necessary.

You can copy in any of the following ways.

- <Ctrl> + <C>
- Right-click, and choose the context menu item [Copy]
- On the [Edit] menu, choose [Copy]

You can paste in any of the following ways.

- <Ctrl> + <V>
- Right-click, and choose the context menu item [Paste]
- On the [Edit] menu, choose [Paste]

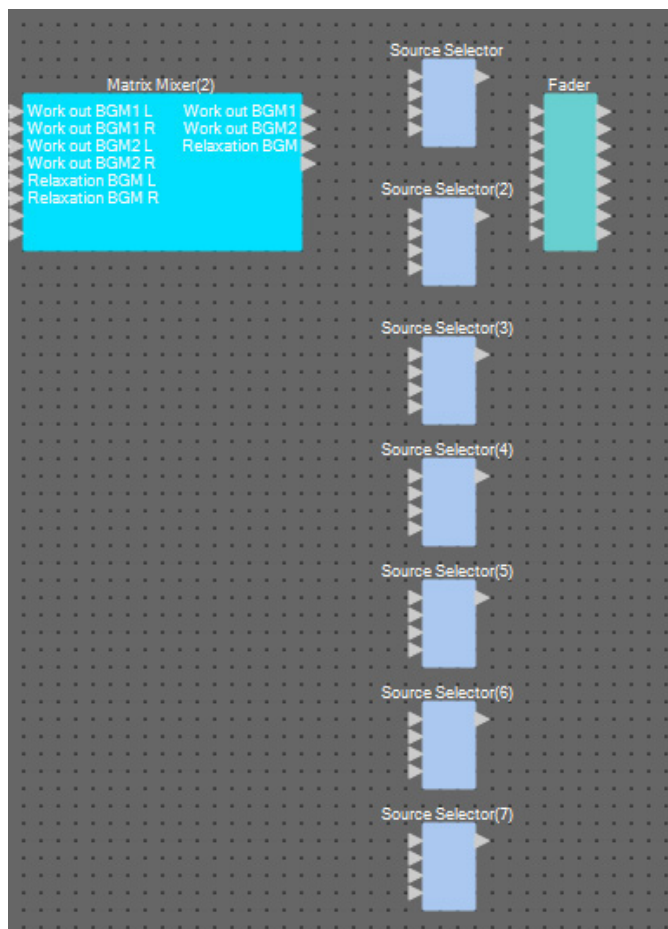

8. Drag and drop to connect “Matrix Mixer(2)” output ports 1 through 3 to “Source Selector” input ports 1 through 3.

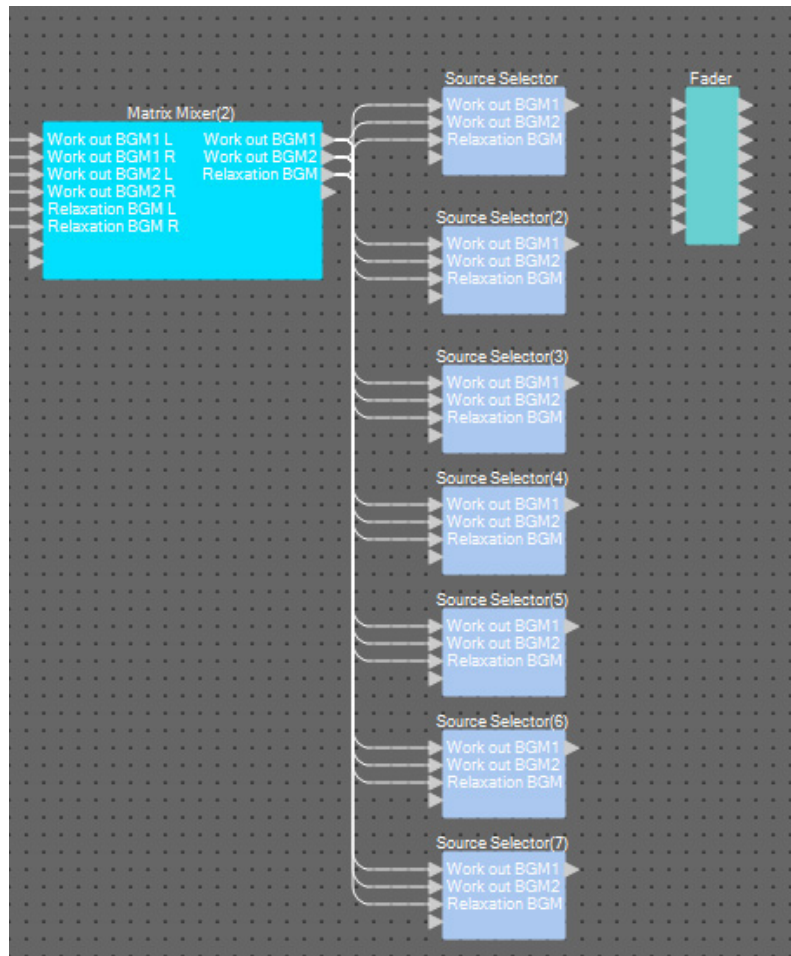

9. Assign a label to each “Source Selector” so that it can be easily distinguished.

Click the label area of each “Source Selector” component to edit it.

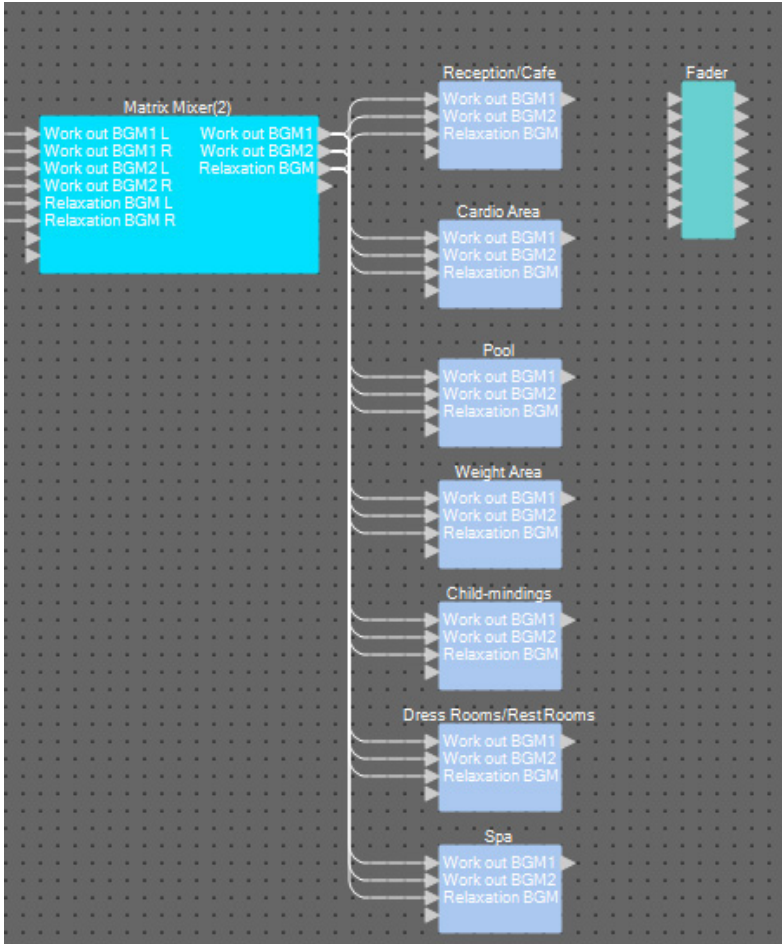
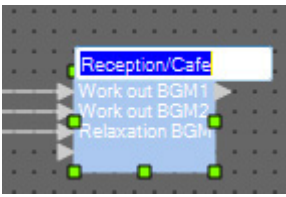

Source Selector	Reception/Cafe
Source Selector(2)	Cardio Area
Source Selector(3)	Pool
Source Selector(4)	Weight Area
Source Selector(5)	Child-mindings
Source Selector(6)	Dress Rooms/ Rest Rooms
Source Selector(7)	Spa

- 10.** Drag and drop to connect output port 1 of each “Source Selector” to “Fader” input ports 1 through 7.

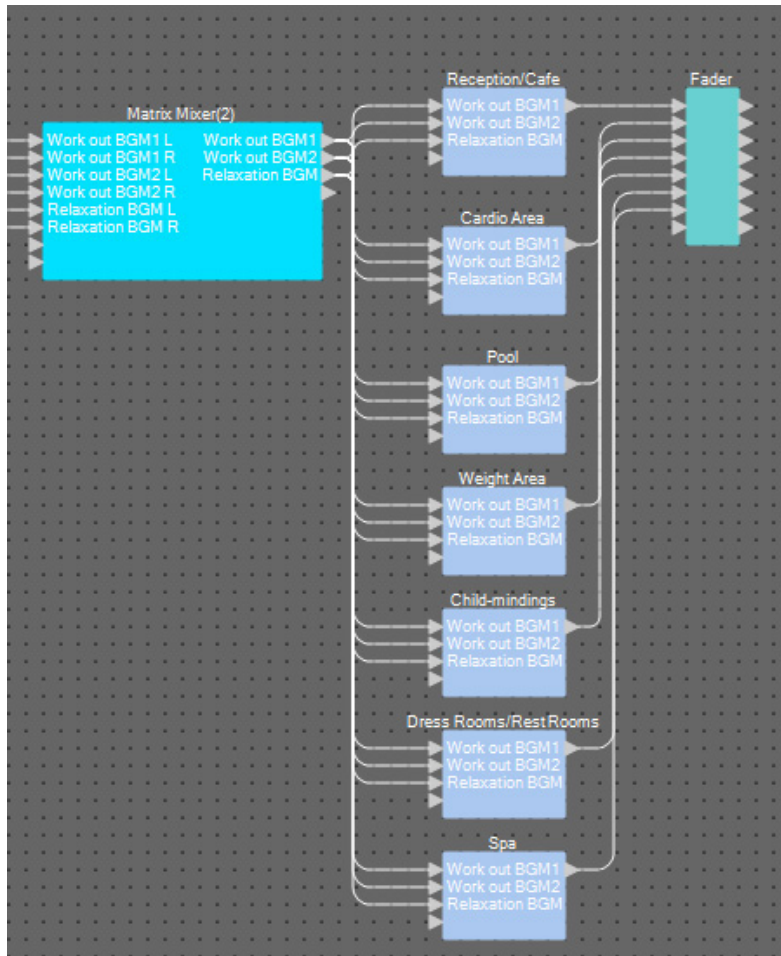

- 11.** Double-click “Fader.”

The “Fader” component editor opens.

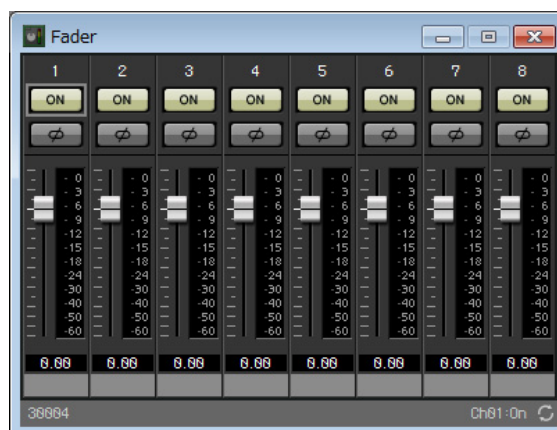

12. Assign a name to channels 1 through 7.

Clicking the label area of each “Source Selector” component makes it editable; copy this to make the process easier.

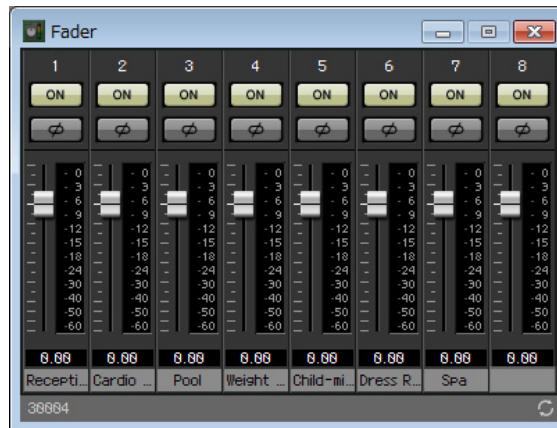

13. Turn off channel 8, and then click the [x] button in the upper right to close the component editor.

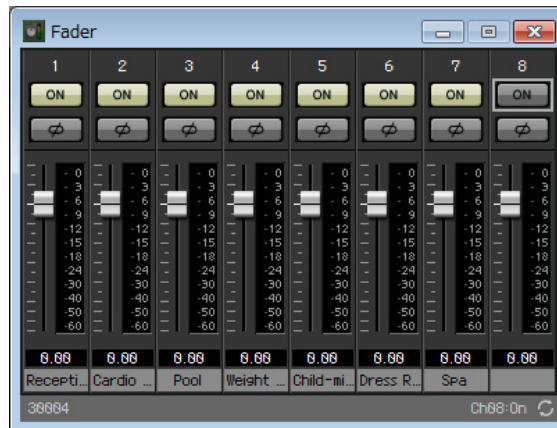

14. Drag and drop to connect “Fader” output ports 1 through 7 to “Paging” Program 1 through 7.

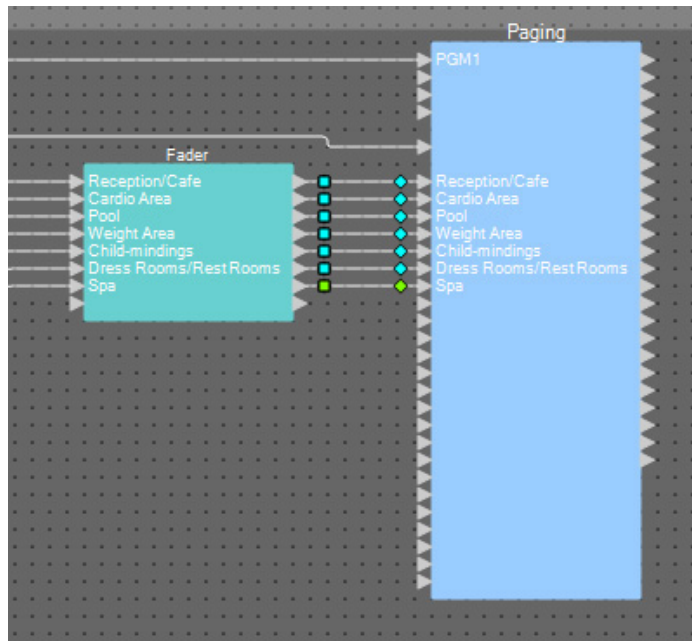

■ Placing and connecting the components related to BGM (stereo) and wireless mic input

Here you'll place and connect the components related to the background music (stereo) and wireless mic input that is broadcast to Studio A/B and the Spin Area.

1. From the “Components” area, drag and drop the following components onto the design sheet.

- “Source Selector” (4Source/2Ch)
- “Fader” (4Ch)
- “Ducker” (Stereo)
- “Matrix Mixer” (4In/2Out)
- “HPF” (Mono)
- “Gate” (Mono)
- “Compressor” (Mono)
- “PEQ” (Mono/3Band)

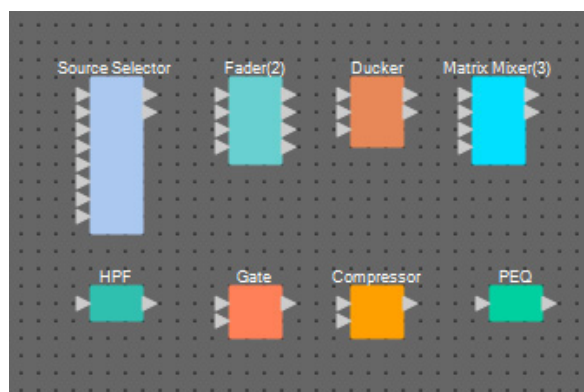

2. Click “Source Selector” to select it.

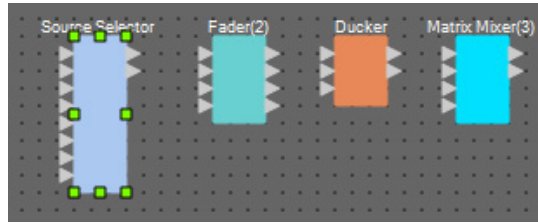

3. Copy the selected component, and paste it two times. Alternatively, drag and drop the selected component while holding down <Ctrl>.

Change the location of the components as necessary.

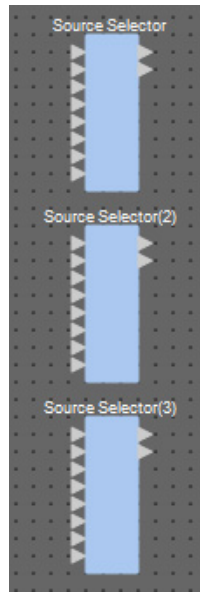

4. Assign a label to each “Source Selector” so that it can be easily distinguished.

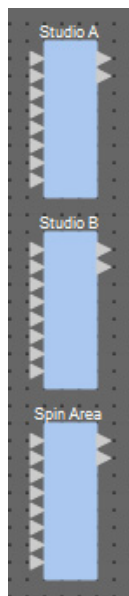

Source Selector	Studio A
Source Selector(2)	Studio B
Source Selector(3)	Spin Area

5. Drag and drop to connect “ANALOG IN” output ports 1 through 6 to each “Source Selector” Src1-1 through Src3-2.

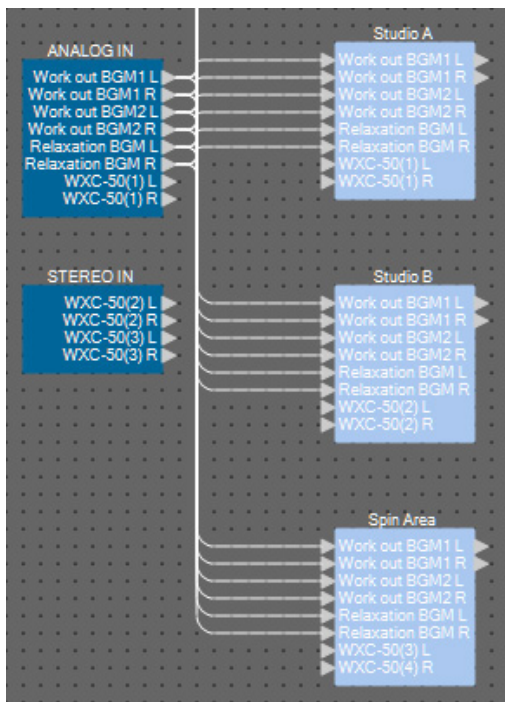

6. Drag and drop to connect the WXC-50’s outputs to each “Source Selector” Src4-1 and Src4-2.

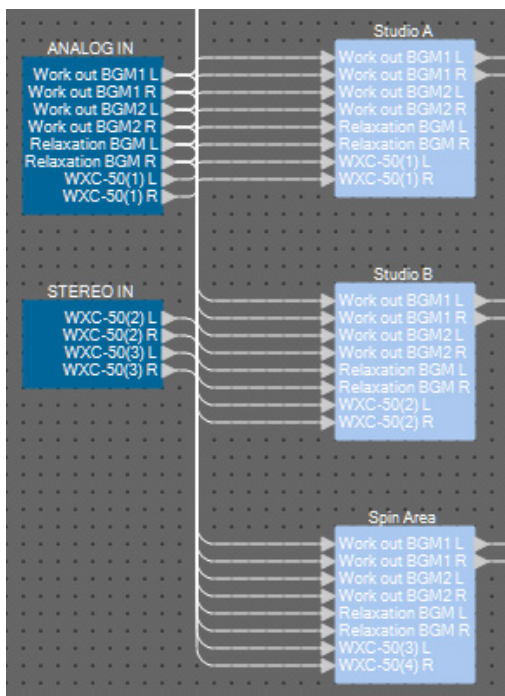

ANALOG IN 7 and 8	Studio A Src4-1 and Src4-2
STEREO IN 1L and 1R	Studio B Src4-1 and Src4-2
STEREO IN 2L and 2R	Spin Area Src4-1 and Src4-2

7. Drag and drop to connect between the ports from “HPF” to “PEQ.”



8. Select the area from “HPF” through “PEQ,” so that the components and wires are selected.

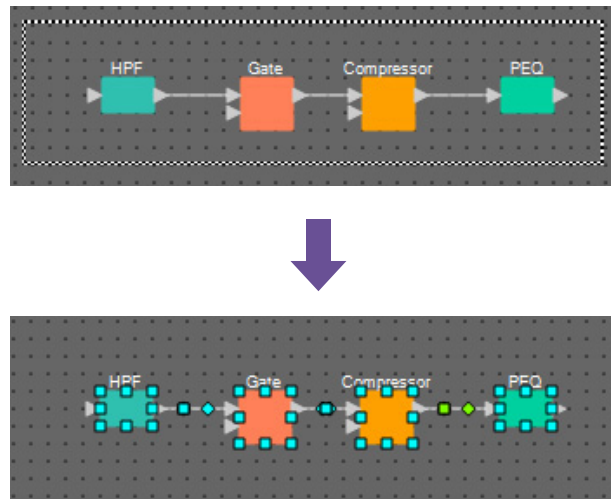

9. On the [Edit] menu, choose [Create User Defined Block]; in the dialog box, set IN as 1, set OUT as 1, and click the [OK] button.

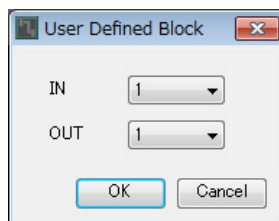

10. As necessary, change the position, size, and arrangement of the components in the User Defined Block.

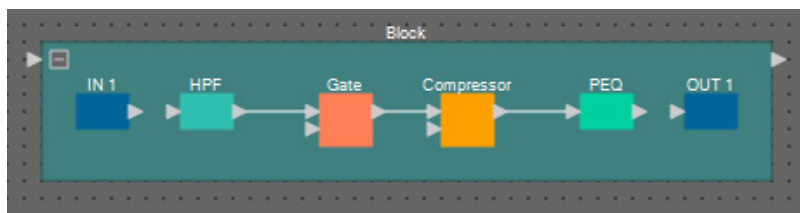

11. Drag and drop to connect the ports “IN 1” to “HPF” and “PEQ” to “OUT 1.”

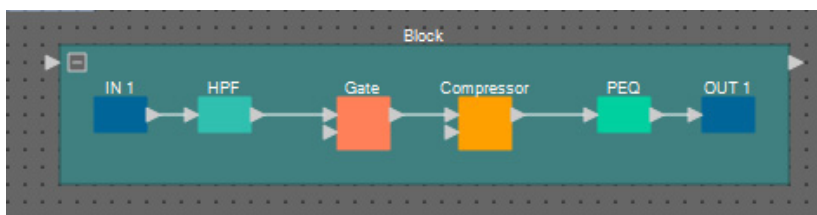

- 12.** Click somewhere other than a component or wire in the User Defined Block, so that the User Defined Block is selected.

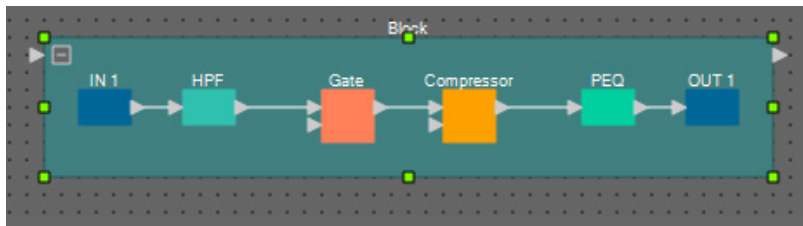

- 13.** Copy the selected User Defined Block, and paste it two times. Alternatively, drag and drop the selected User Defined Block while holding down <Ctrl>.

Change the location of the User Defined Block as necessary.

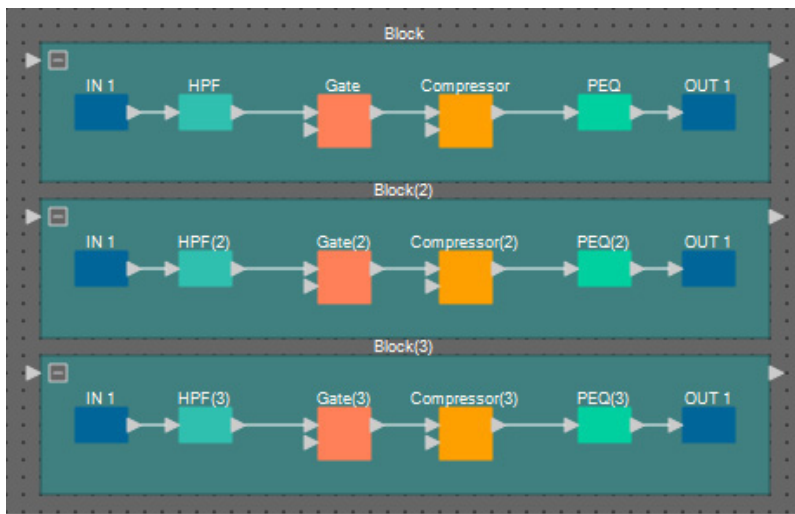

- 14.** Name the label of each User Defined Block so that it can be easily distinguished.

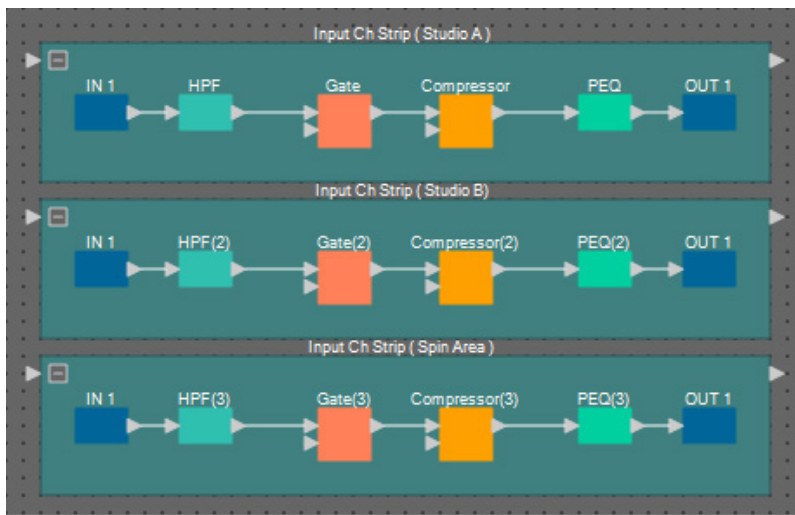

Block	Input Ch Strip (Studio A)
Block(2)	Input Ch Strip (Studio B)
Block(3)	Input Ch Strip (Spin Area)

- 15.** Drag and drop to connect “YDIF IN” output ports 1 through 3 to the input port of each User Defined Block.

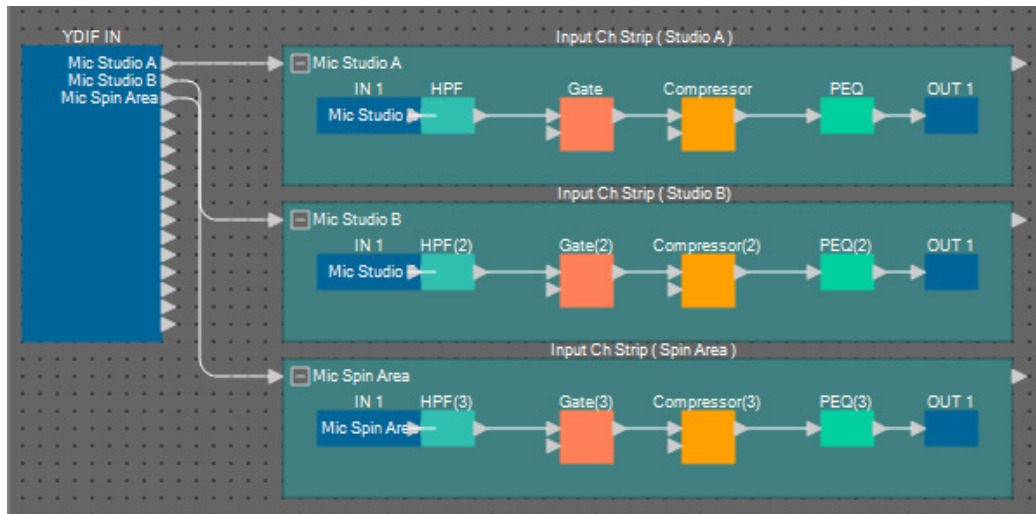

YDIF IN 1	Input Ch Strip (Studio A)
YDIF IN 2	Input Ch Strip (Studio B)
YDIF IN 3	Input Ch Strip (Spin Area)

- 16.** Select the area from “Fader(2)” through “Matrix Mixer(3),” so that the components are selected.



- 17.** On the [Edit] menu, choose [Create User Defined Block]; in the dialog box, set IN as 3, set OUT as 2, and click the [OK] button.

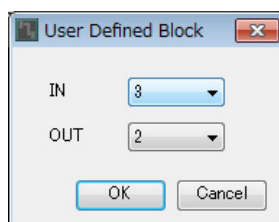

- 18.** As necessary, change the position, size, and arrangement of the components in the User Defined Block.

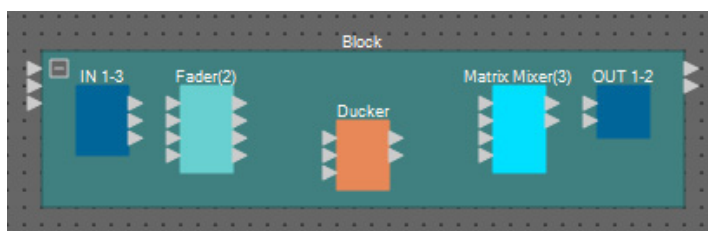

19. Assign a name to the input ports of the User Defined Block.

Enter the port names in the “Port Name” dialog box. To access the “Port Name” dialog box, click the port, and then click the button located at the right of the [Label] editing area in the “Properties” area. The output port names are automatically entered during a subsequent step.

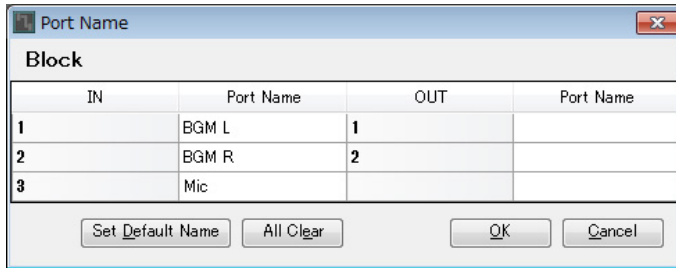

IN 1	BGM L
IN 2	BGM R
IN 3	Mic

20. After you’ve entered the port names, click the [OK] button.

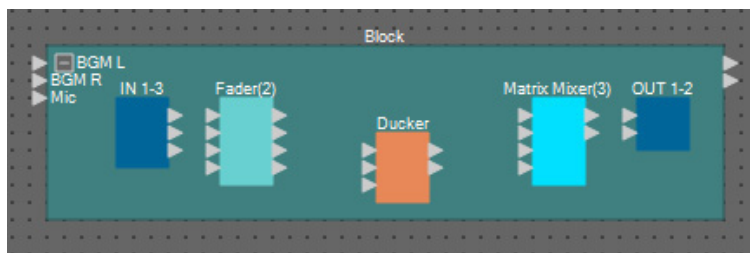

21. Also enter a port name for the User Defined Block’s “IN.”

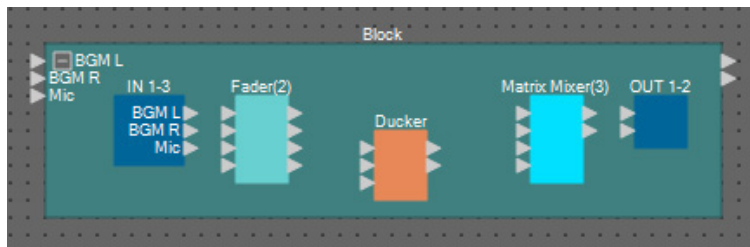

22. Drag and drop to connect “IN” output ports 1 and 2 to “Fader(2)” input ports 3 and 4; connect “IN” output port 3 to “Fader(2)” input port 1.

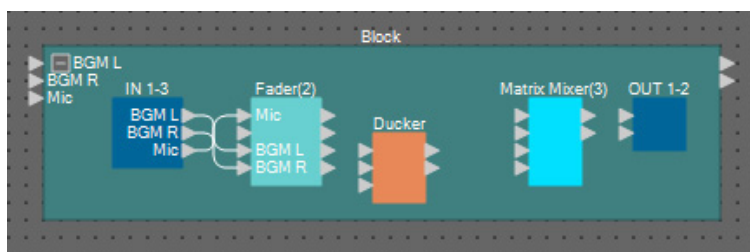

- 23.** Drag and drop to connect “Fader(2)” output port 1 to “Ducker” KeyIN and “Matrix Mixer(3)” input port 1; connect “Fader(2)” output ports 3 and 4 to input “Ducker” ports 1 and 2.

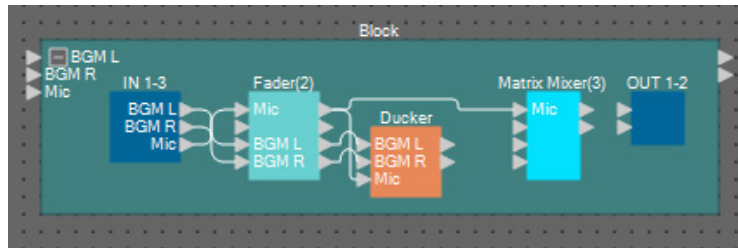

- 24.** Double-click “Ducker”; verify that KEY IN is set to KEYIN, and then close the component editor.

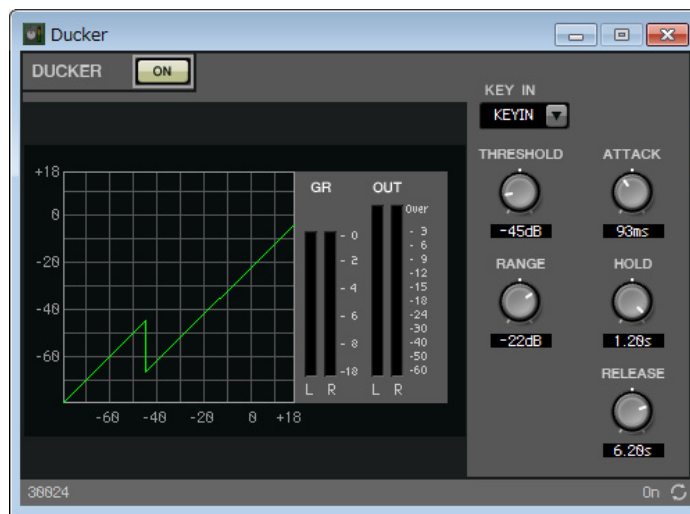

- 25.** Drag and drop to connect “Ducker” 1L and 1R to “Matrix Mixer(3)” input ports 3 and 4.

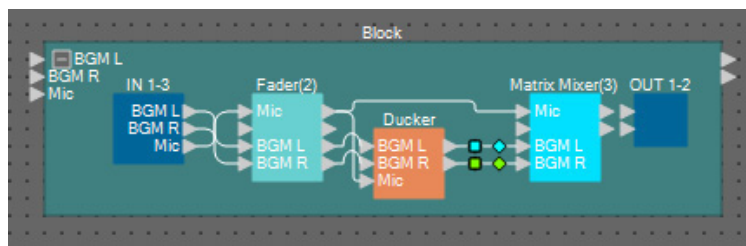

26. Double-click “Matrix Mixer(3).”

The “Matrix Mixer” component editor appears.

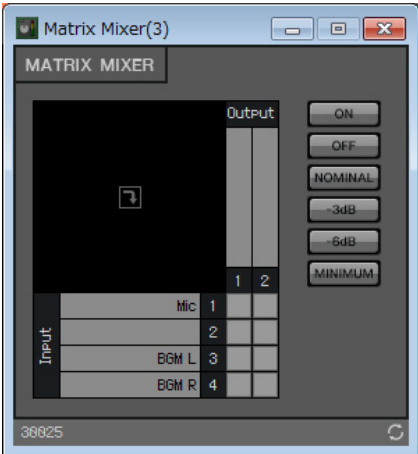

27. Enter port names for Output.

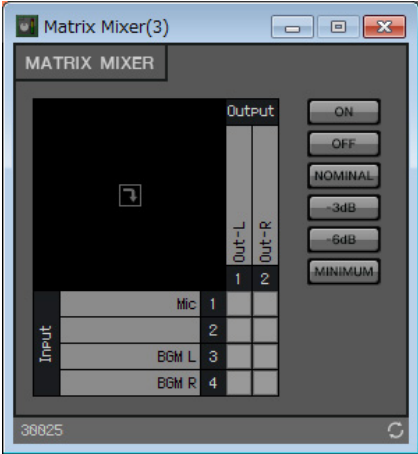

Output 1	Out-L
Output 2	Out-R

28. Enable Mic for Out-L and Out-R, enable BGM L for Out-L and BGM R for Out-R; then click the [x] button in the upper right to close the component editor.

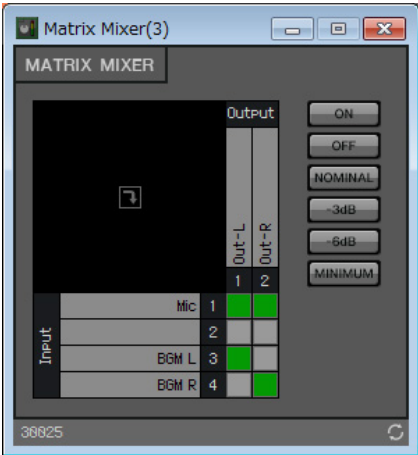

29. Drag and drop to connect the “Matrix Mixer(3)” output ports to the “OUT” input ports.

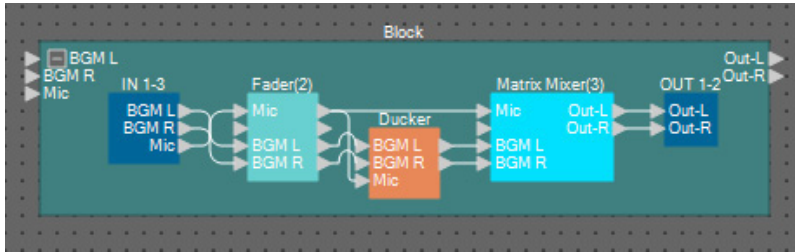

30. Click somewhere other than a component or wire in the User Defined Block, so that the User Defined Block is selected.

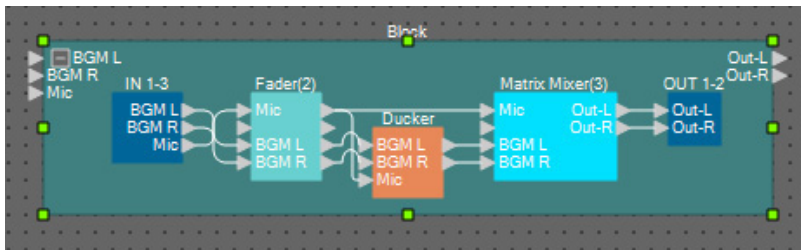

31. Copy the selected User Defined Block, and paste it two times. Alternatively, drag and drop the selected User Defined Block while holding down <Ctrl>.

Change the location of the User Defined Block as necessary.

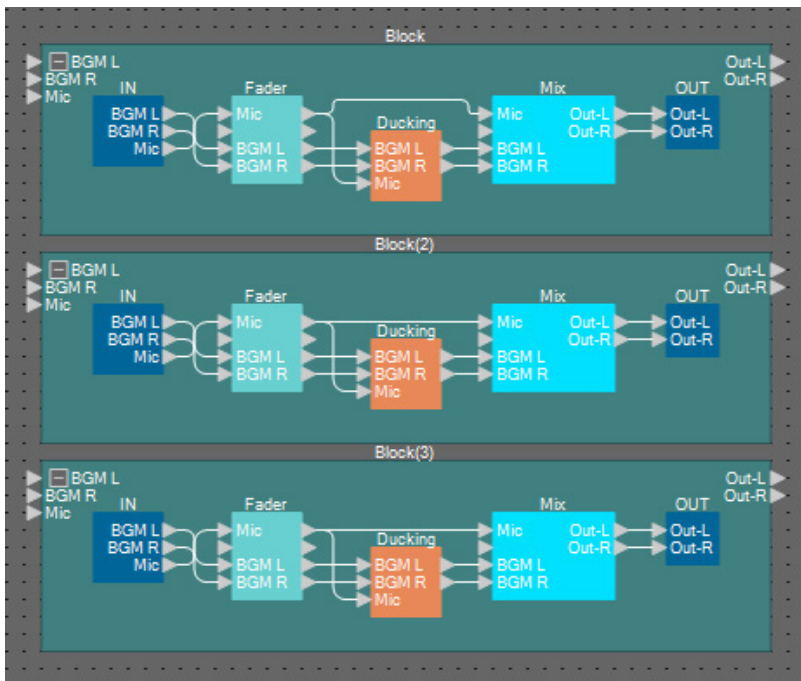

32. Name the label of each User Defined Block so that it can be easily distinguished.

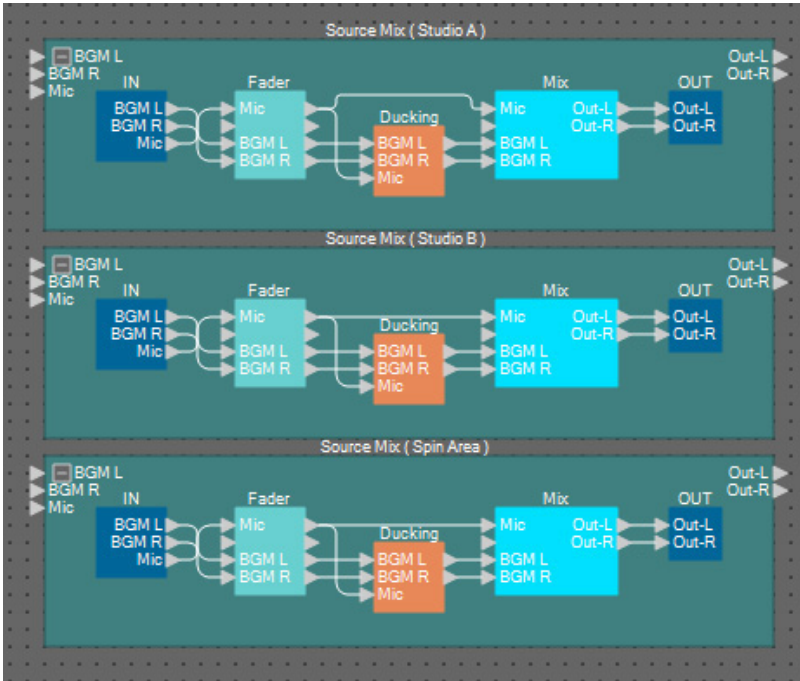

Block	Source Mix (Studio A)
Block(2)	Source Mix (Studio B)
Block(3)	Source Mix (Spin Area)

33. Drag and drop to connect “Studio A” (Source Selector) output ports 1 and 2 to “Source Mix Studio A” (User Defined Block) input ports 1 and 2; connect the “Input Ch Strip (Studio A)” (User Defined Block) output port to “Source Mix Studio A” (User Defined Block) input port 3.

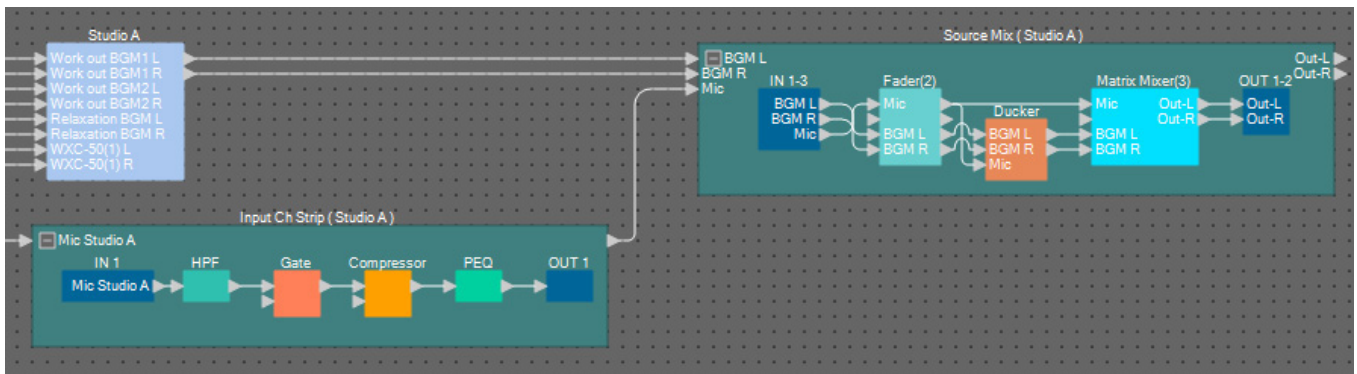

34. Connect Studio B and Spin Area in the same way.

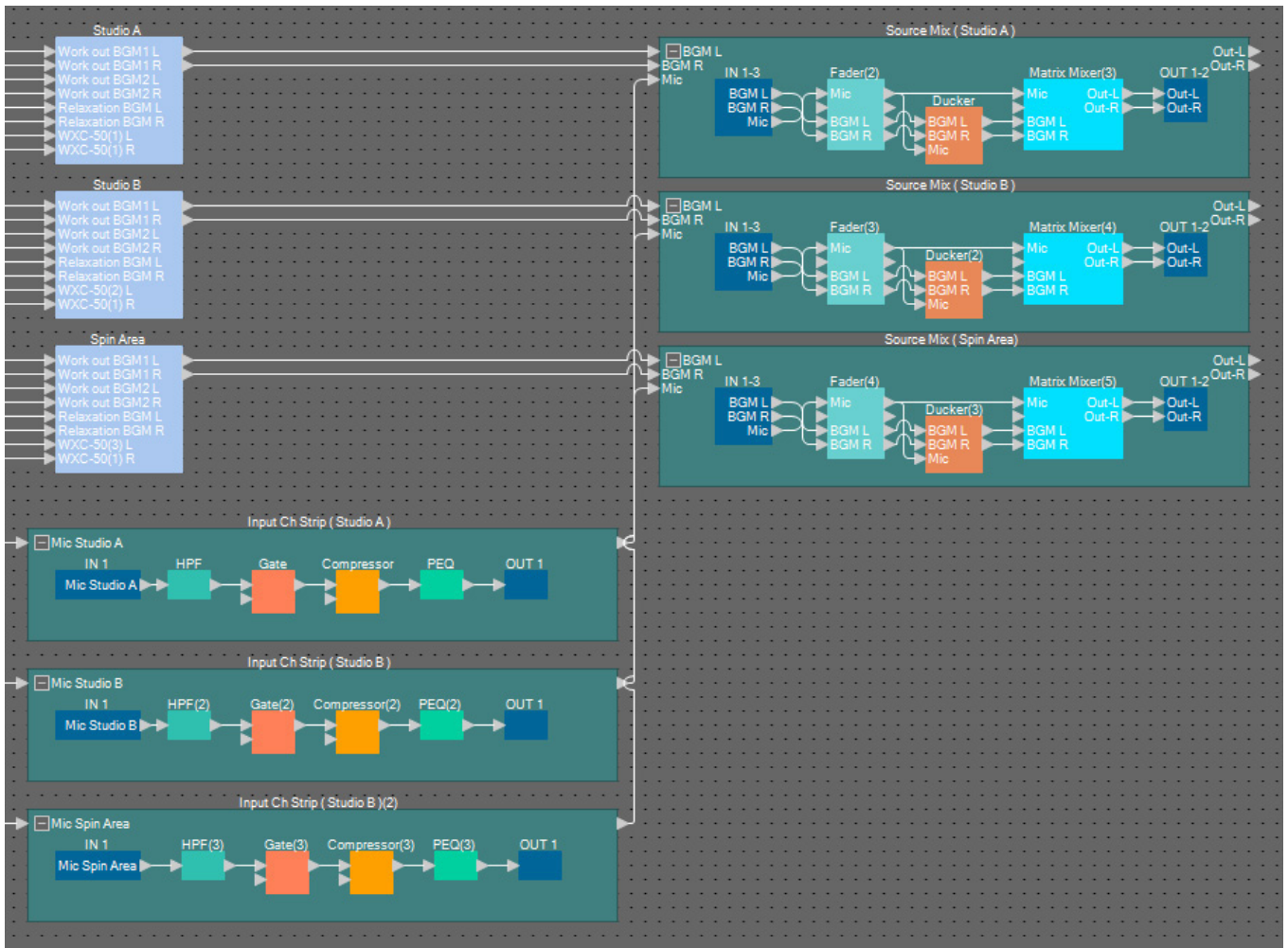

35. Drag and drop to connect each Source Mix output jack to “Paging” Program 8 through 13.

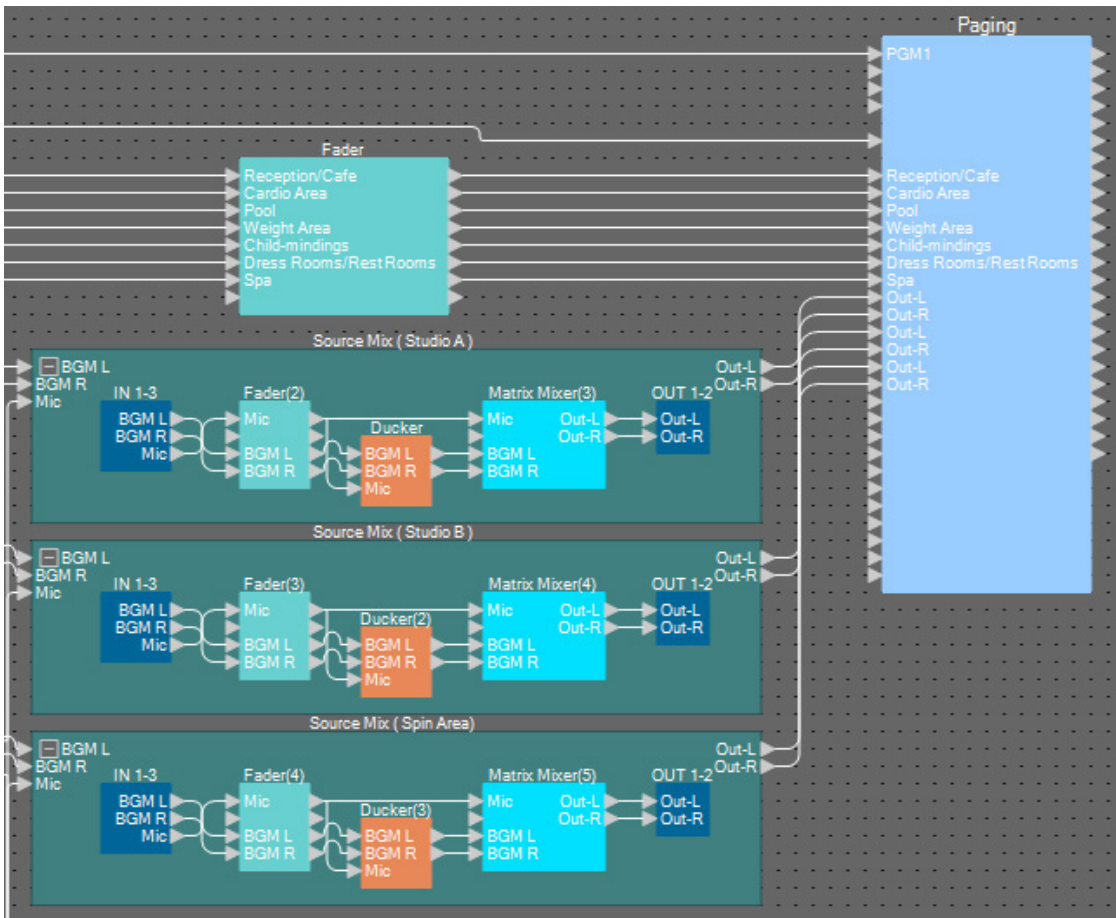

Source Mix (Studio A)	Out-L	Program 8
	Out-R	Program 9
Source Mix (Studio B)	Out-L	Program 10
	Out-R	Program 11
Source Mix (Spin Area)	Out-L	Program 12
	Out-R	Program 13

■ Making settings for Paging

Here you'll make settings for the "Paging" component.

1. Assign the "Paging" input/output port names.

Enter the port names in the "Port Name" dialog box. To access the "Port Name" dialog box, click the port, and then click the button located at the right of the [Label] editing area in the "Properties" area.

After you've entered the input port names, you can proceed efficiently by clicking the listed port name, and then copying and pasting it to the output port name field.

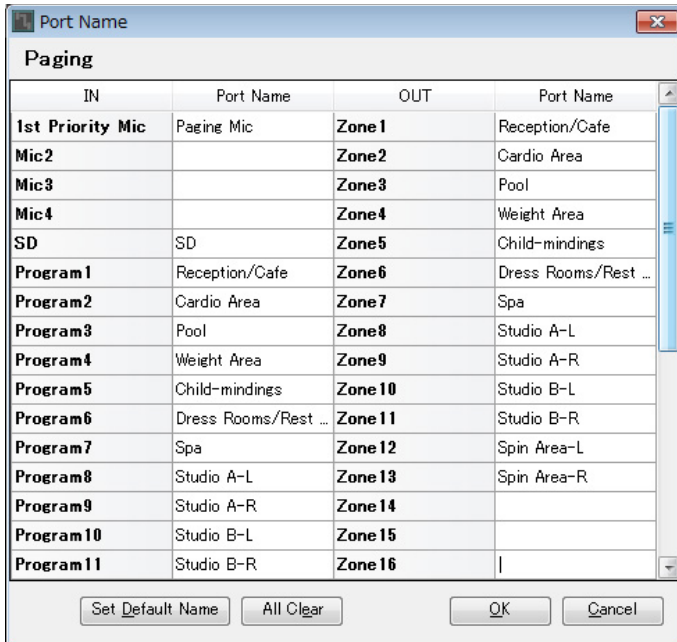

1sr Priority Mic	Paging Mic
SD	SD
Program1	Reception/Cafe
Program2	Cardio Area
Program3	Pool
Program4	Weight Area
Program5	Child-mindings
Program6	Dress Rooms/Rest Rooms
Program7	Spa
Program8	Studio A-L
Program9	Studio A-R
Program10	Studio B-L
Program11	Studio B-R
Program12	Spin Area-L
Program13	Spin Area-R
Zone1	Reception/Cafe
Zone2	Cardio Area
Zone3	Pool
Zone4	Weight Area
Zone5	Child-mindings
Zone6	Dress Rooms/Rest Rooms
Zone7	Spa
Zone8	Studio A-L
Zone9	Studio A-R
Zone10	Studio B-L
Zone11	Studio B-R
Zone12	Spin Area-L
Zone13	Spin Area-R

2. After you've entered the port names, click the [OK] button.

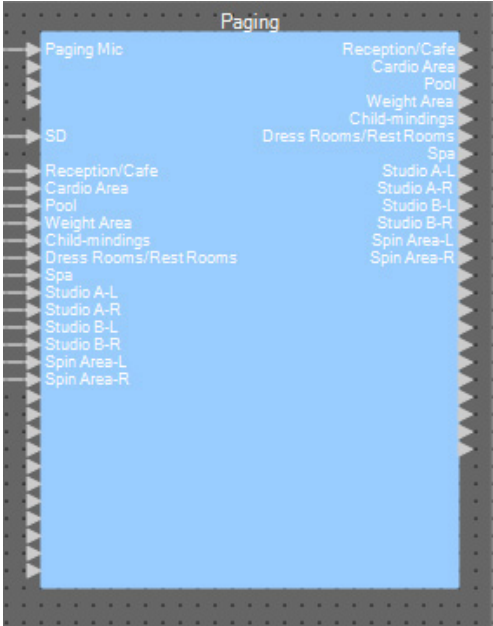

3. Double-click "Paging."

The "Paging" component editor opens.



4. To create a zone group, click the [ZONE Group] button.

The “Zone Group” window appears.

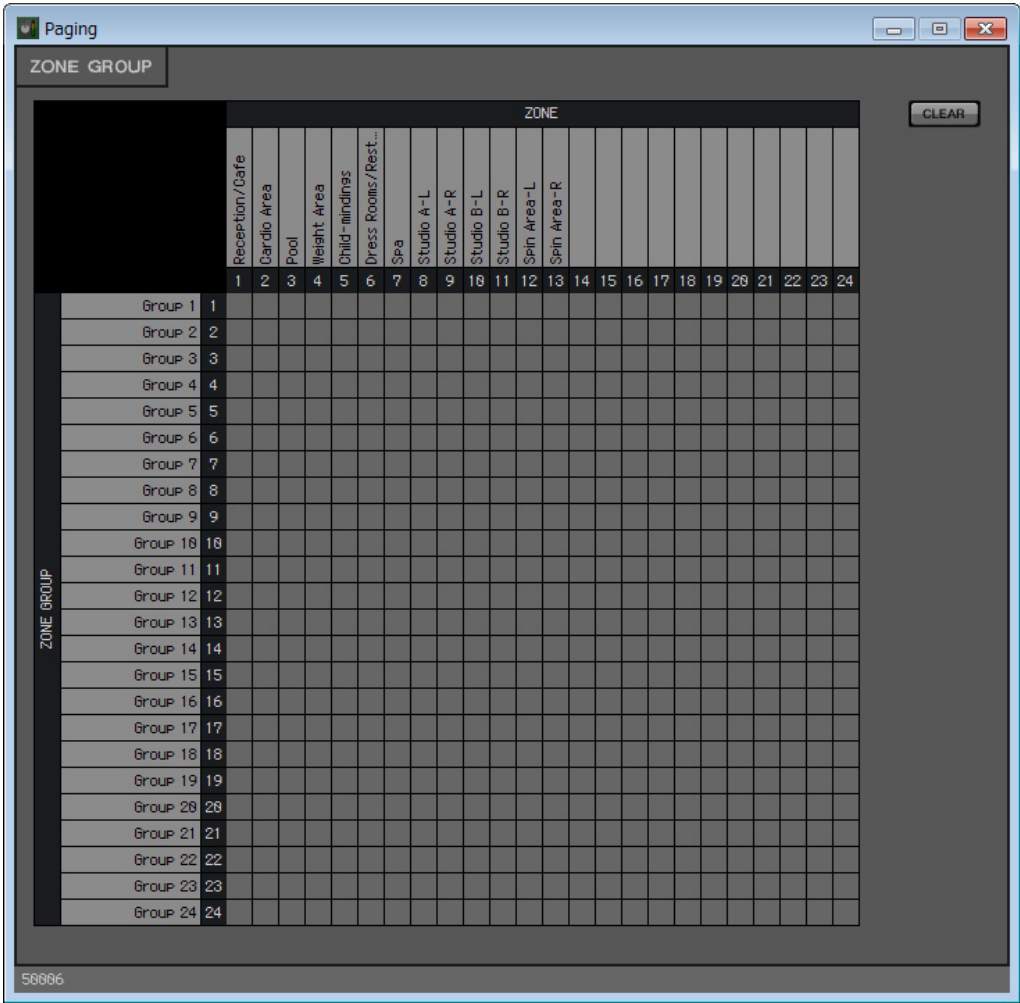

5. Click within the zone group matrix to create zone groups.

In this example, create zone groups as follows.

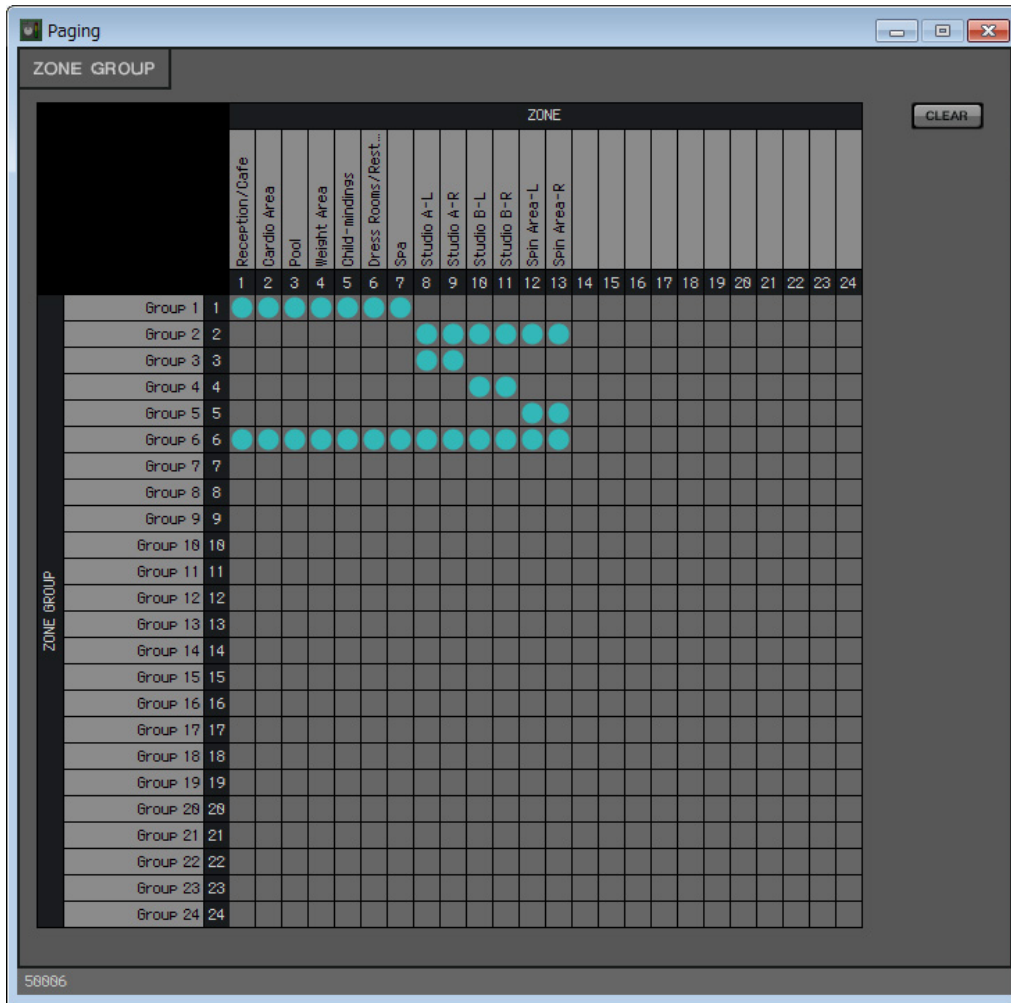

Group 1	ZONE 1 through 7	All monaural broadcast areas
Group 2	ZONE 8 through 13	All stereo broadcast areas
Group 3	ZONE 8 and 9	STUDIO A
Group 4	ZONE 10 and 11	STUDIO B
Group 5	ZONE 12 and 13	Spin Area
Group 6	ZONE 1 through 13	Broadcast to entire facility

6. Enter the zone group names.

Double-click the name of each ZONE GROUP and edit it.

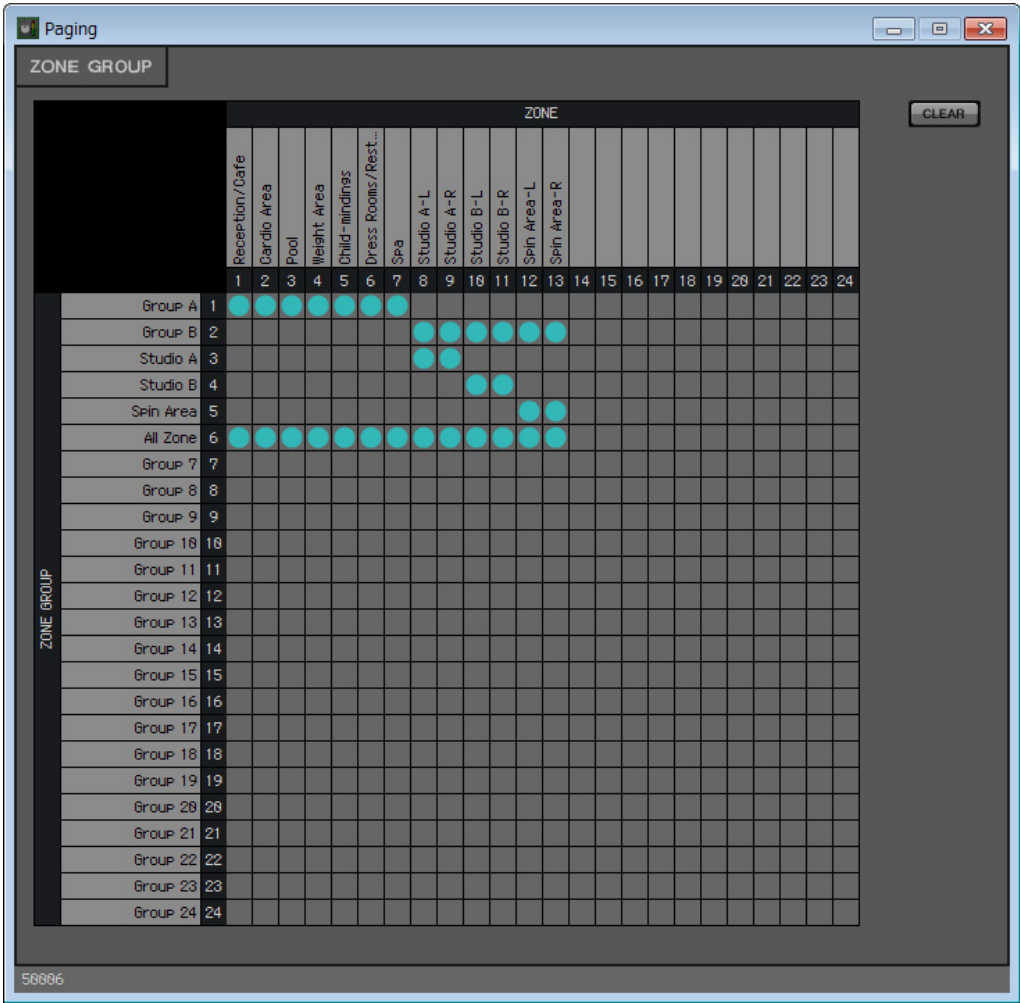

Group 1	Group A
Group 2	Group B
Group 3	Studio A
Group 4	Studio B
Group 5	Spin Area
Group 6	All Zone

7. Click the [x] button in the upper right to close the window.

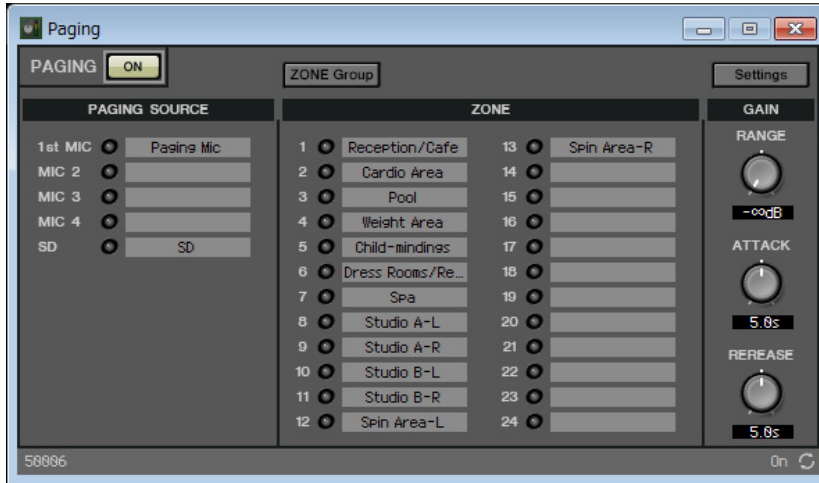

8. To make assignments for the zone/message select buttons of the PGM1/PGX1, click the [Settings] button.

The “PGM1/PGX1” dialog box appears.

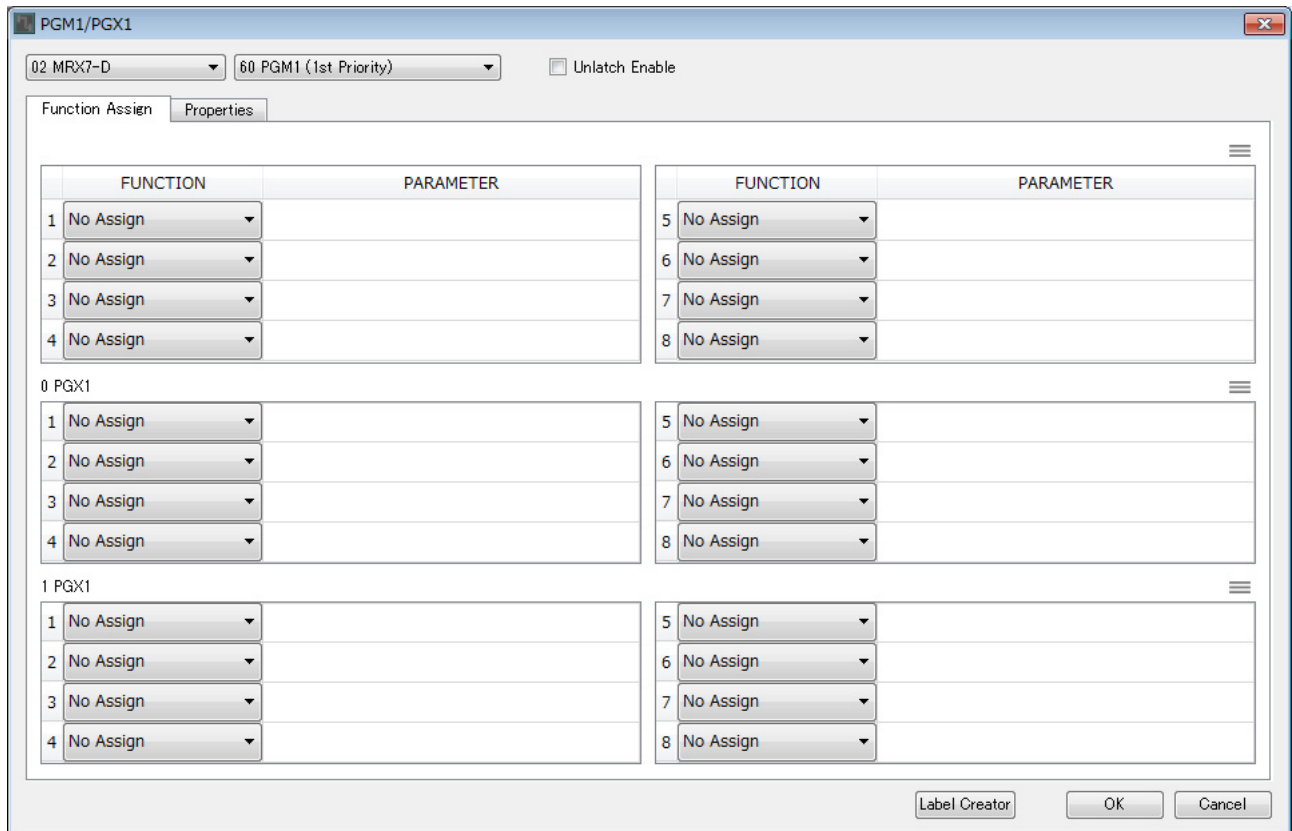

9. Make assignments to zone/message select buttons.

In this example, make the following assignments.

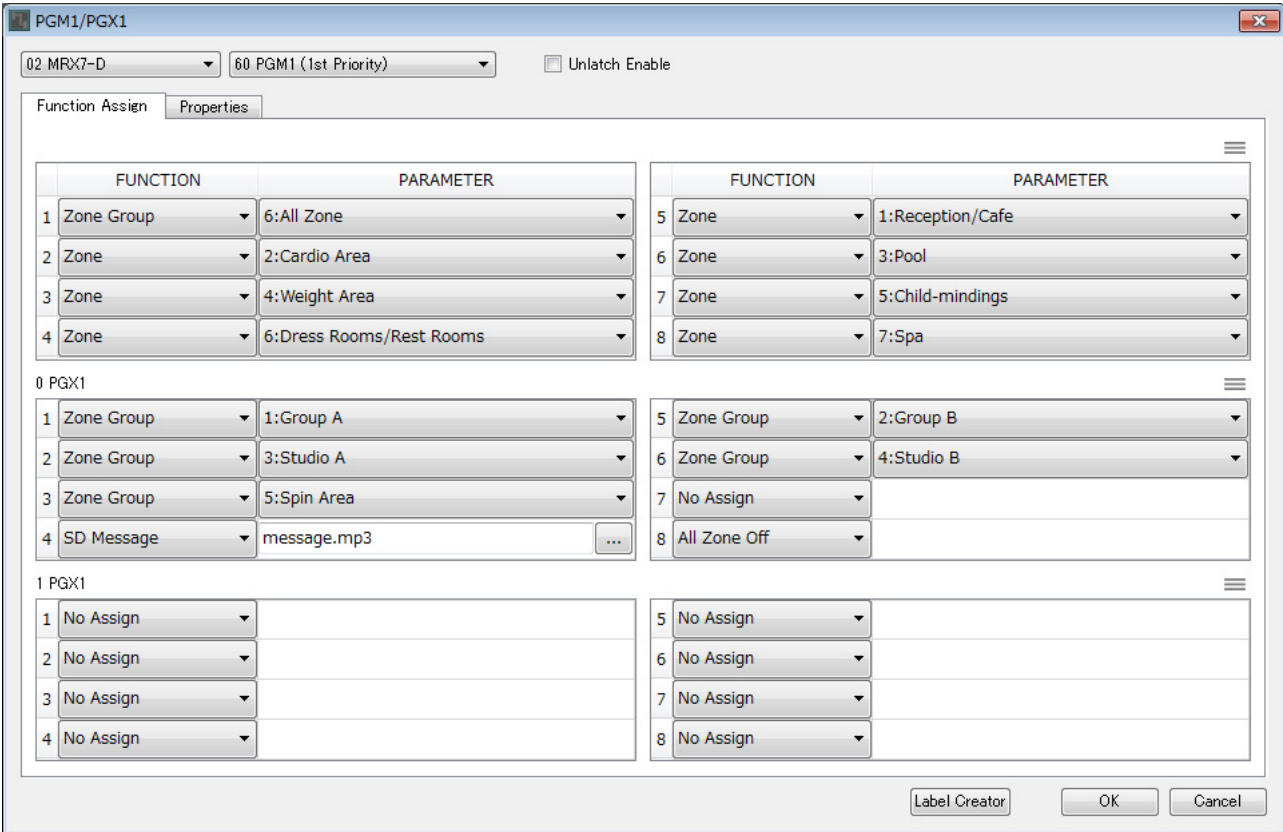

PGM1	1	Zone Group	All Zone
	2	Zone	Cardio Area
	3	Zone	Weight Area
	4	Zone	Dress Rooms/ Rest Rooms
	5	Zone	Reception/Cafe
	6	Zone	Pool
	7	Zone	Child-mindings
	8	Zone	Spa

PGX1	1	Zone Group	Group A
	2	Zone Group	Studio A
	3	Zone Group	Spin Area
	4	SD Message	any desired file
	5	Zone Group	Group B
	6	Zone Group	Studio B
	7	No Assign	
	8	All Zone Off	

10. If necessary, click the [Label Creator] button to create labels for the PGM1/PGX1.
“PGM Label Creator” starts.

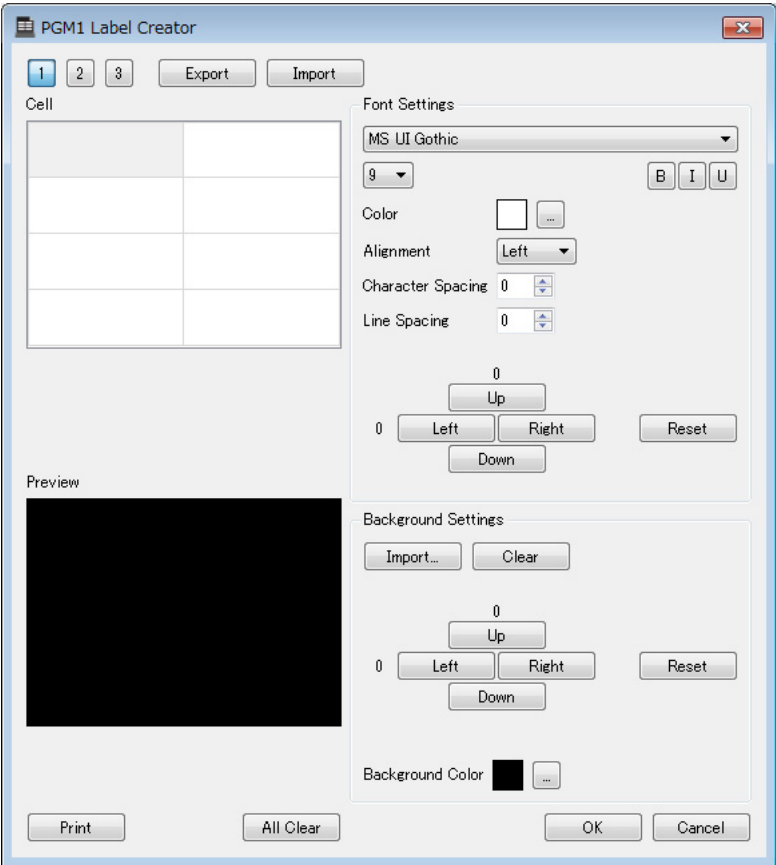

11. Design the label that you want to print.

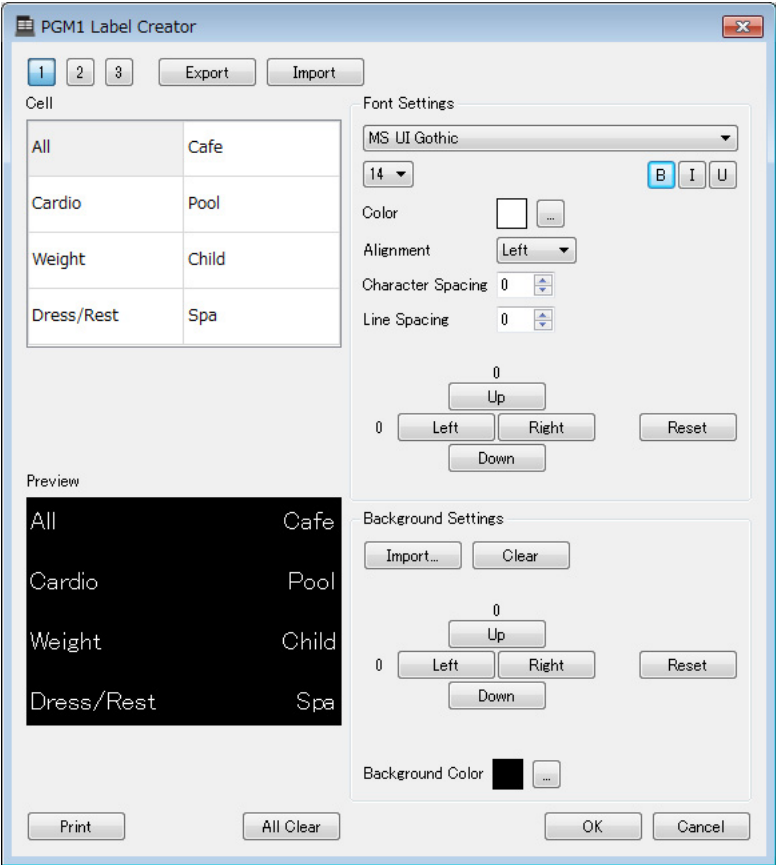

12. Click the [Print] button to print, or click the [Export] button to save as a file; then click the [OK] button.

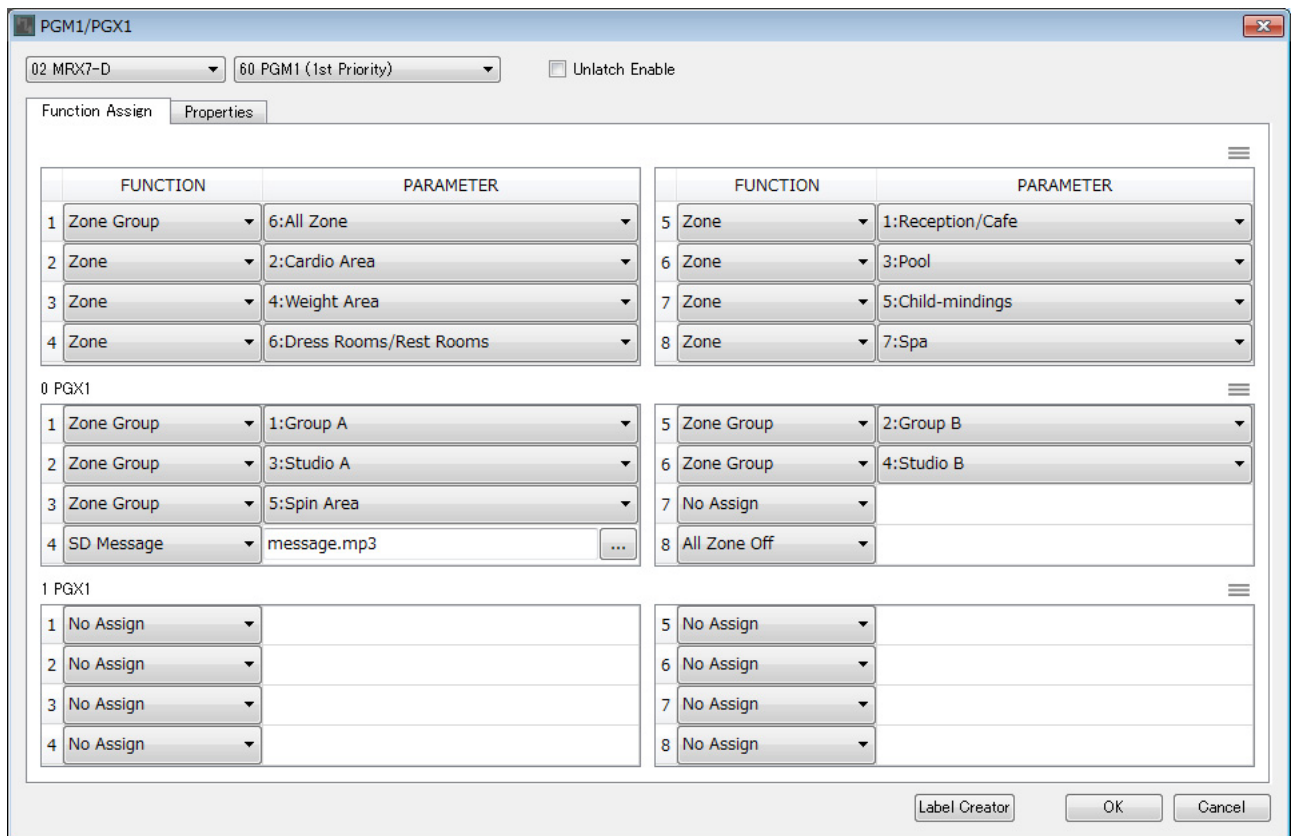

13. Click the [Properties] tab.

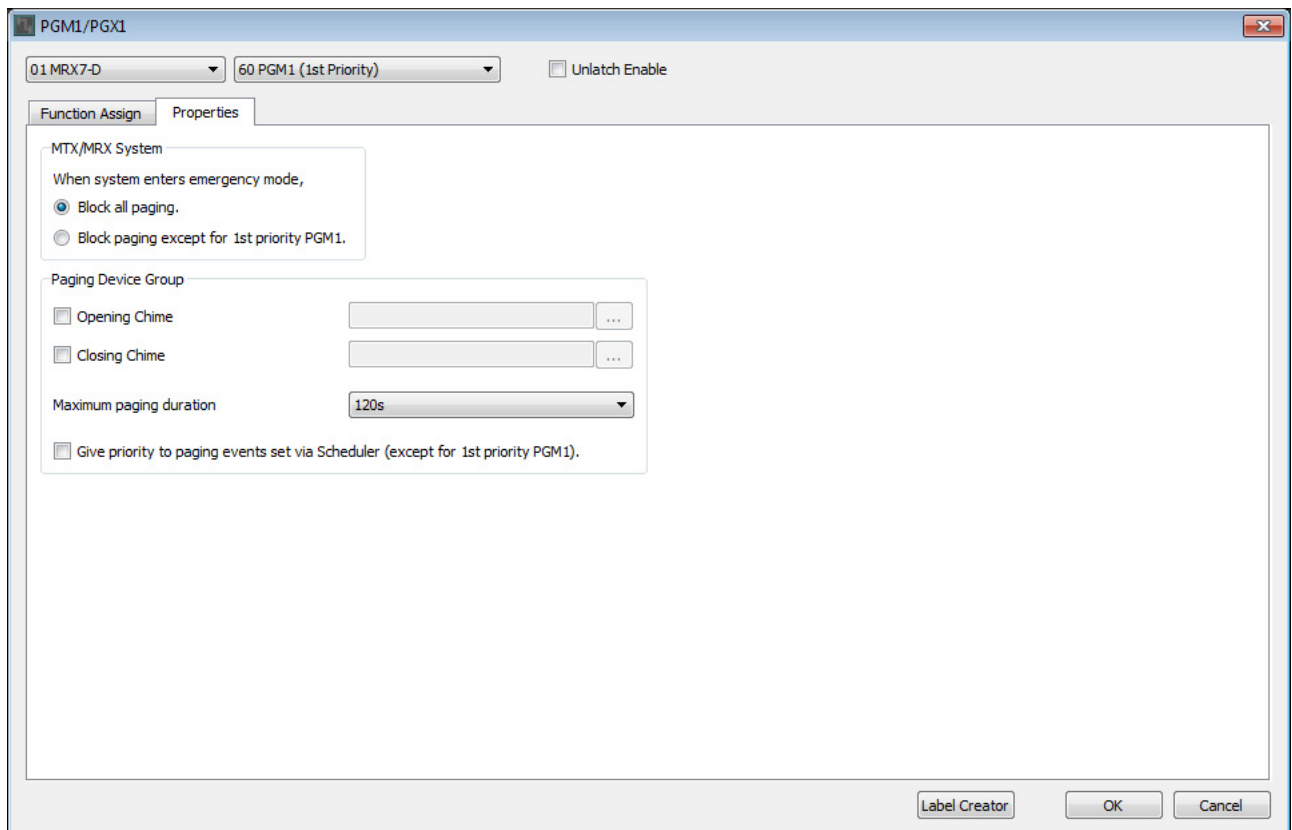

14. Make common settings for the PGM1 units in the MTX/MRX system or the Paging Device Group.

Here you'll specify that paging broadcast is possible only for the 1st Priority Mic when in emergency mode, and that a chime will sound before and after the broadcast.

With these settings, pressing the PTT button of the 1st Priority Mic when in emergency mode will not sound a chime, and ATTACK and RELEASE will be 0 seconds.

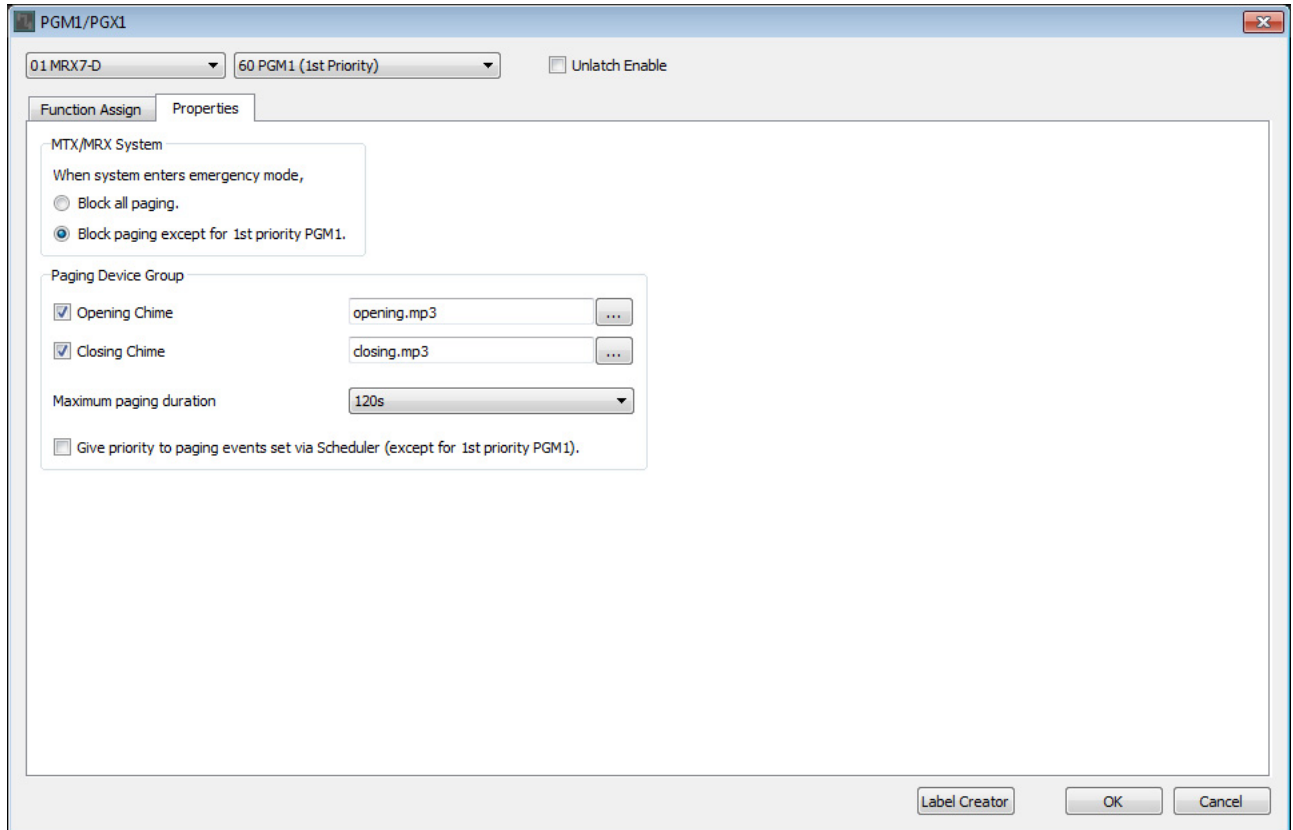

15. Click the [OK] button to close the dialog box.

■ Placing and connecting the components related to BGM (monaural) output

Here you'll place and connect the components related to the output of the background music (monaural) that is broadcast to the facility.

This is output to the XMV units connected via DANTE.

1. From the "Components" area, drag and drop the following components onto the design sheet.

- "PEQ" (8Band/Mono)
- "Fader" (1Ch)
- "Speaker Processor" (1Way)
- "DANTE OUT 1-16"

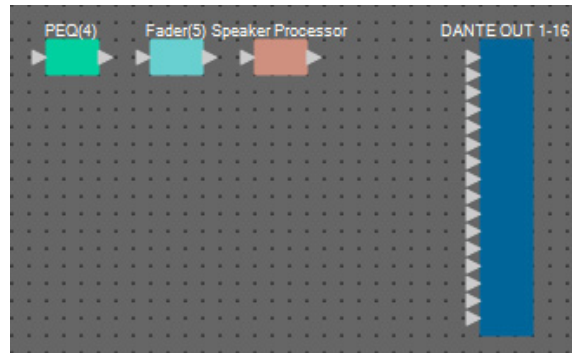

2. Drag and drop to connect between the ports from "PEQ(4)" to "Speaker Processor."

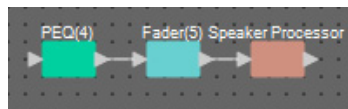

3. Select the area from "PEQ(4)" through "Speaker Processor," so that the components and wires are selected.



4. On the [Edit] menu, choose [Create User Defined Block]; in the dialog box, set IN as 1, set OUT as 1, and click the [OK] button.

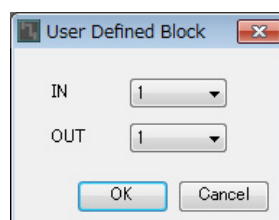

5. As necessary, change the position, size, and arrangement of the components in the User Defined Block.

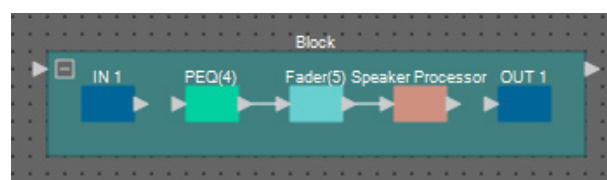

6. Drag and drop to connect the ports “IN 1” to “PEQ(4),” and “Speaker Processor” to “OUT 1.”

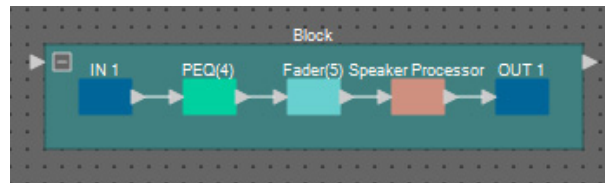

7. Click somewhere other than a component or wire in the User Defined Block, so that the User Defined Block is selected.

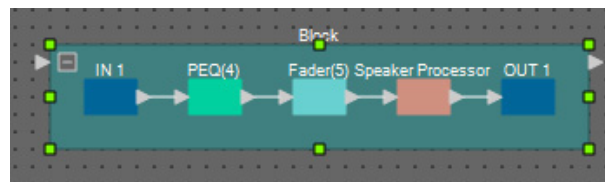

8. Copy the selected User Defined Block, and paste it six times. Alternatively, drag and drop the selected User Defined Block while holding down <Ctrl>.

Change the location of the User Defined Block as necessary.

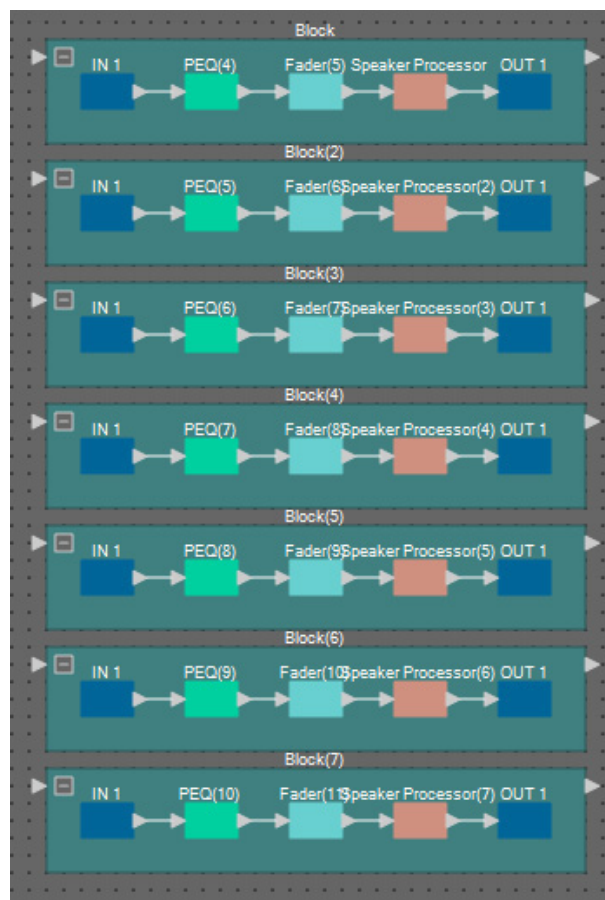

9. Name the label of each User Defined Block so that it can be easily distinguished.

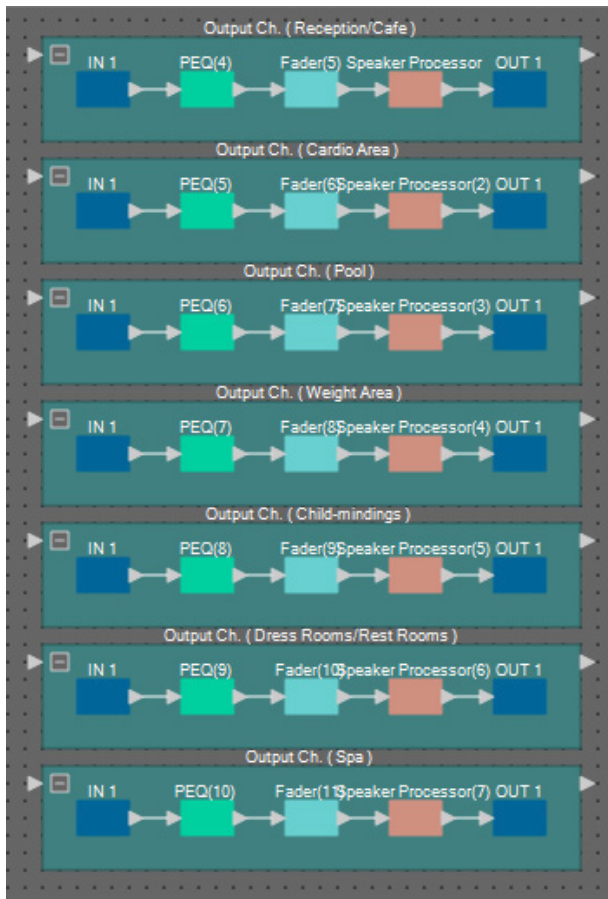

Block	Output Ch. (Reception/Cafe)
Block(2)	Output Ch. (Cardio Area)
Block(3)	Output Ch. (Pool)
Block(4)	Output Ch. (Weight Area)
Block(5)	Output Ch. (Child-mindings)
Block(6)	Output Ch. (Dress Rooms/Rest Rooms)
Block(7)	Output Ch. (Spa)

10. Drag and drop to connect “Paging” Zone 1 through 7 to the input ports of each User Defined Block.

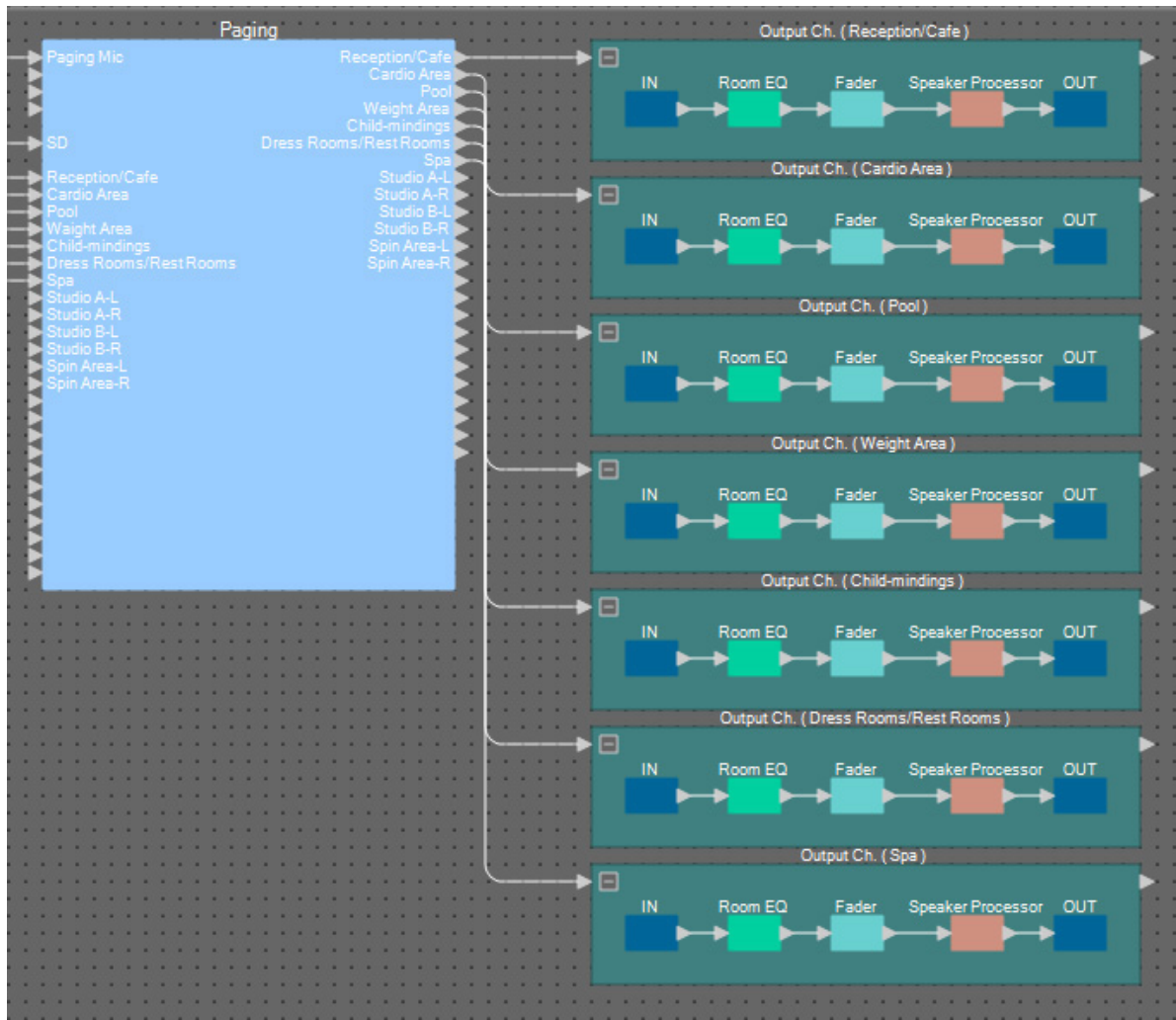

- 11.** Drag and drop to connect the output port of each User Defined Block to “DANTE OUT 1–16” input ports 1 through 7.

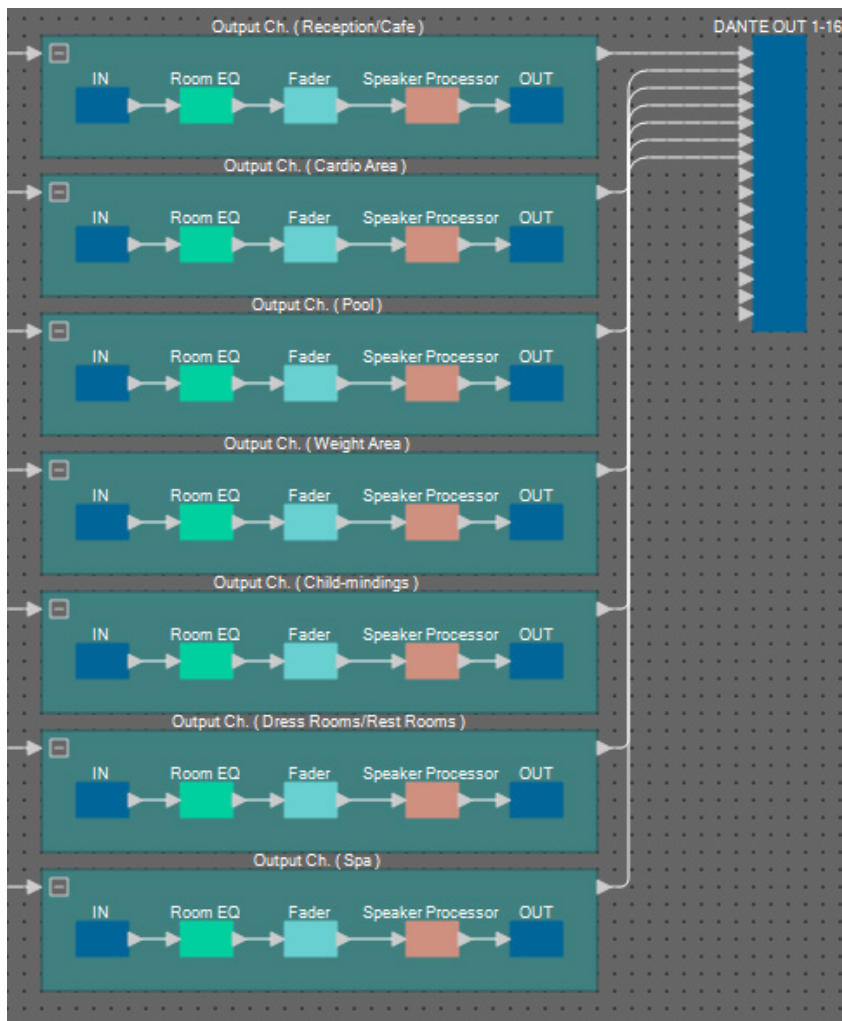

- 12.** Name each label of the “DANTE OUT 1–16” input ports so that they can be easily distinguished.



1	Reception/Cafe
2	Cardio Area
3	Pool
4	Weight Area
5	Child-mindings
6	Dress Rooms/Rest Rooms
7	Spa

■ Placing and connecting the components related to BGM (stereo) output

Here you'll place and connect the components related to the output of the background music (monaural) that is broadcast to the facility.

This is output to the analog output of the MRX7-D.

1. From the “Components” area, drag and drop the following components onto the design sheet.

- “PEQ” (8Band/Mono)
- “Fader” (2Ch)
- “ANALOG OUT”

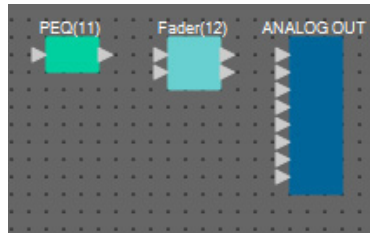

2. Copy and paste “PEQ(11)” once.

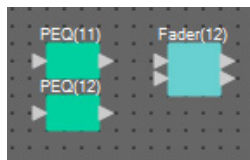

3. Drag and drop to connect the output port of each “PEQ” to the “Fader(12)” input ports.

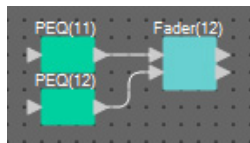

4. Specify “PEQ” and “Fader” as a 2IN/2OUT User Defined Block.

As necessary, change the position, size, and arrangement of the components in the User Defined Block.

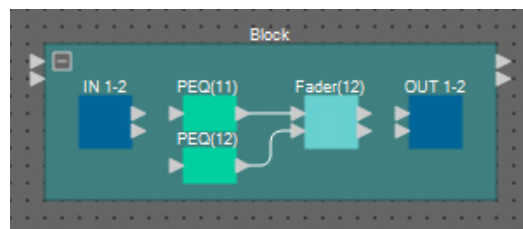

5. Drag and drop to connect the ports “IN 1–2” to each “PEQ,” and “Fader(12)” to “OUT 1–2.”

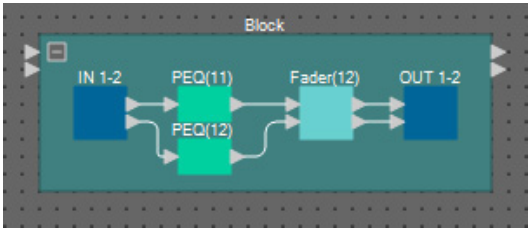

6. Copy the User Defined Block, and paste it two times.

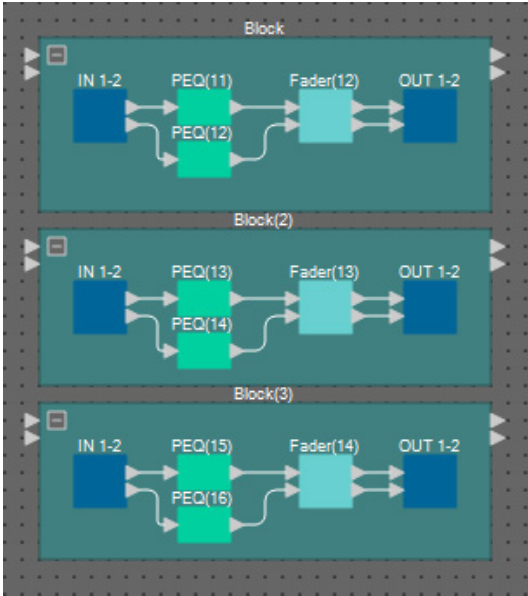

7. Name the label of each User Defined Block so that it can be easily distinguished.

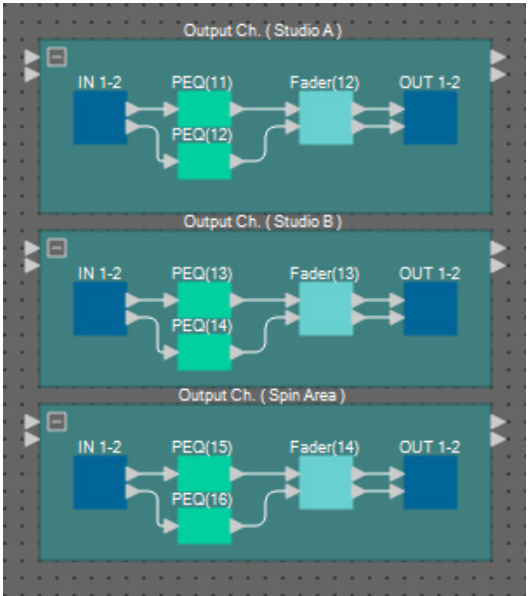

Block	Output Ch. (Studio A)
Block(2)	Output Ch. (Studio B)
Block(3)	Output Ch. (Spin Area)

8. Drag and drop to connect “Paging” Zone 8 through 13 to the input ports of each User Defined Block.

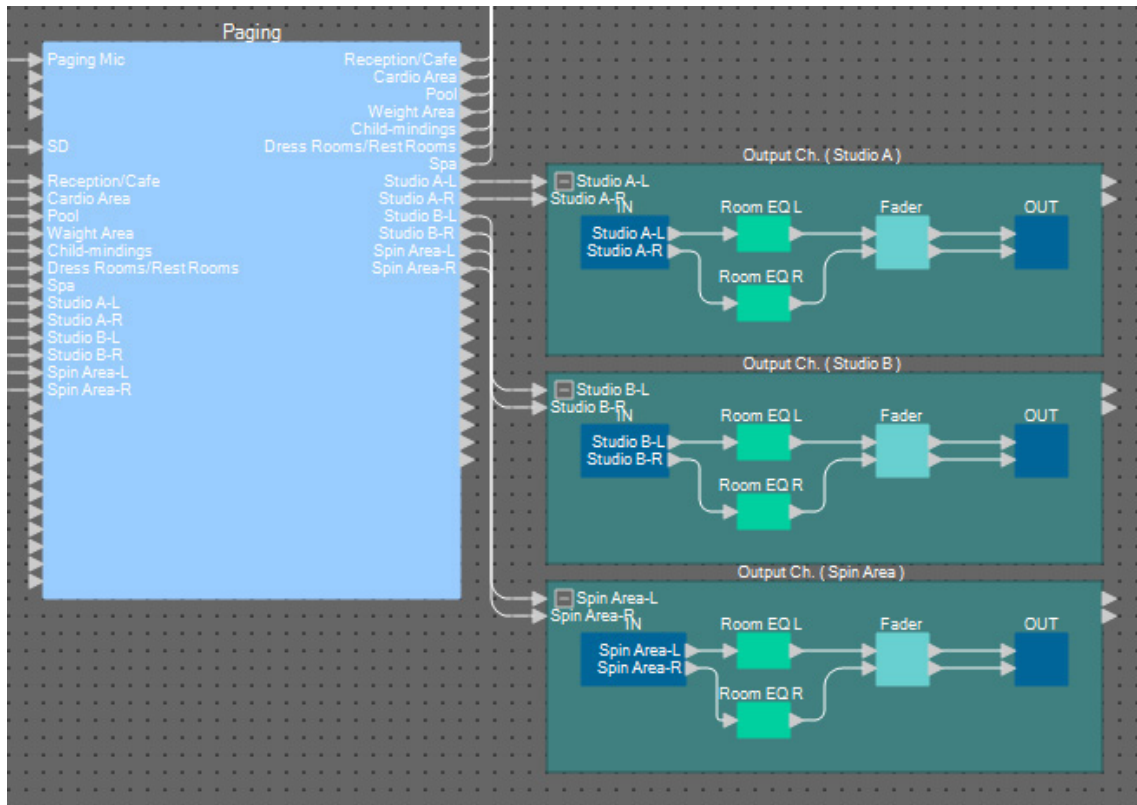

9. Drag and drop to connect the output port of each User Defined Block to “ANALOG OUT” input ports 1 through 6.

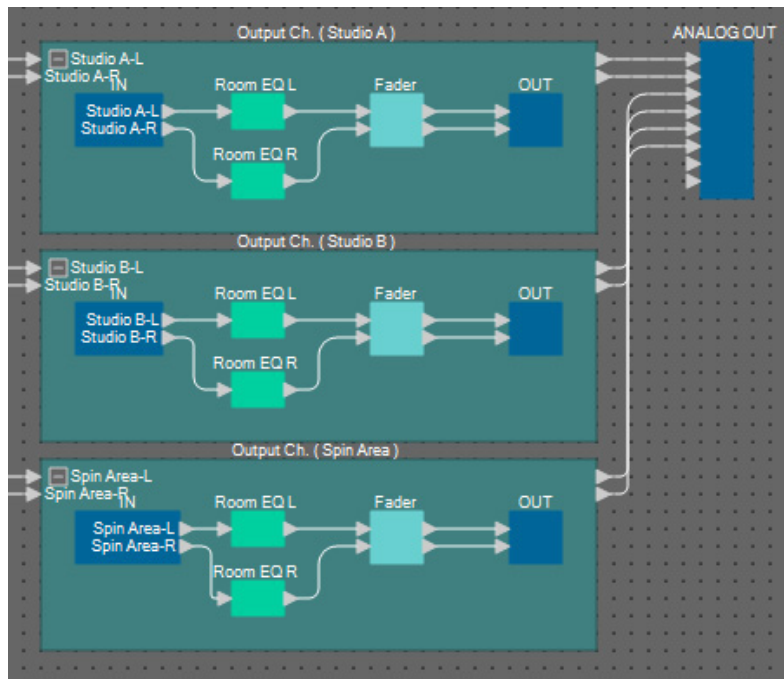

10. Name each label of the “ANALOG OUT” input ports so that they can be easily distinguished.



1	Studio A-L
2	Studio A-R
3	Studio B-L
4	Studio B-R
5	Spin Area-L
6	Spin Area-R

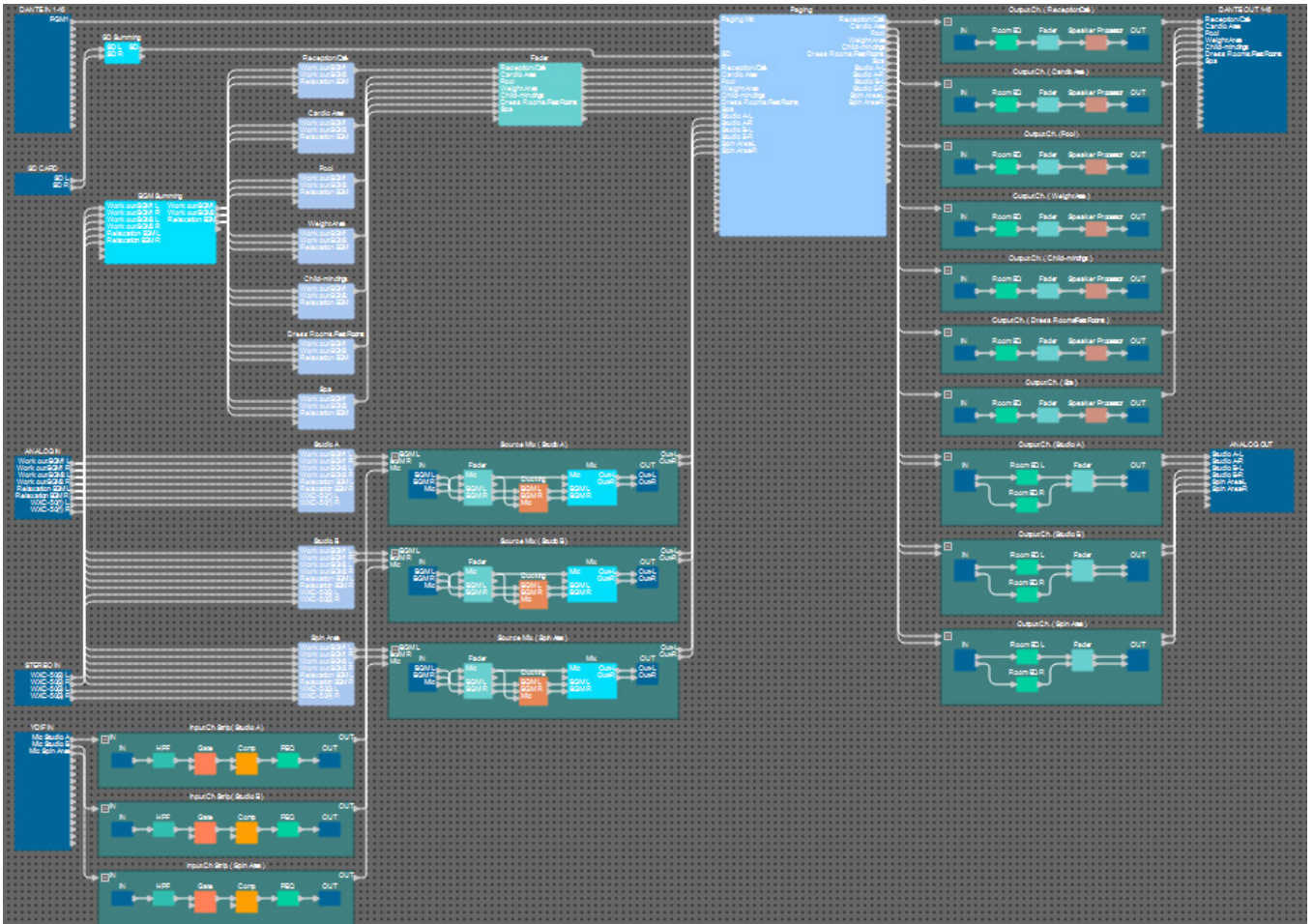

This completes placement and connections for the components. As necessary, move the position of the components, or change the connections of the wires.

Compiling

This performs an analysis to determine whether there are any problems with the placement and wiring of the components in the MRX.

1. Click the [Compile] tool button ( Compile).

Analysis begins.

2. Note the results of analysis.

If the message “Completed successfully” is displayed in the “Message” field, there were no problems.

If there is a problem, click the [Detail] button and proceed as directed.

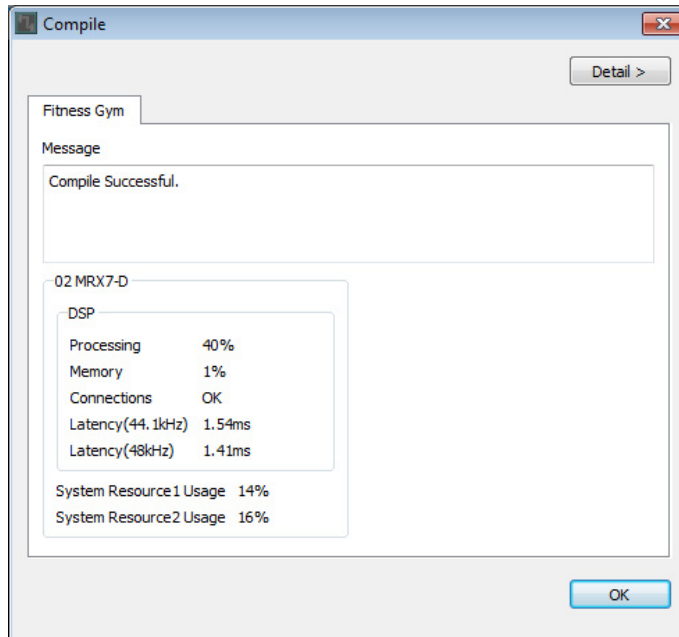

This completes the compiling process.

Setting a parameter link group

In this example, we'll do various things to make the best use of the MCP1's switches, such as combining two faders of a stereo output into a single fader, and combining the L/R ON buttons into a single button.

We'll create parameter link groups that combine multiple level-type or on/off-type parameters, so that a switch of the MCP1 can control multiple parameters simultaneously.

As for a snapshot, you can register parameters by holding down <Ctrl> while you drag and drop, but since there are a total of 24 parameters to be registered for this example, we'll use a different method to register them.

1. In the left side of MRX Designer, open the "Parameter Link Group" area.

This is opened in order to check the parameters that have been registered.

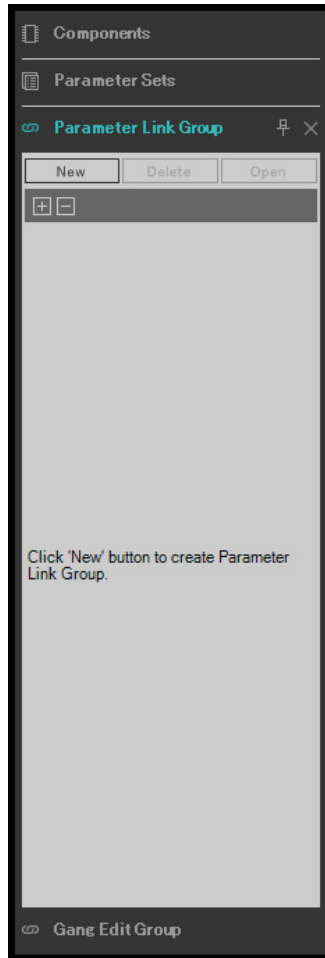

2. In the right side of MRX Designer, open the “Parameters” area.

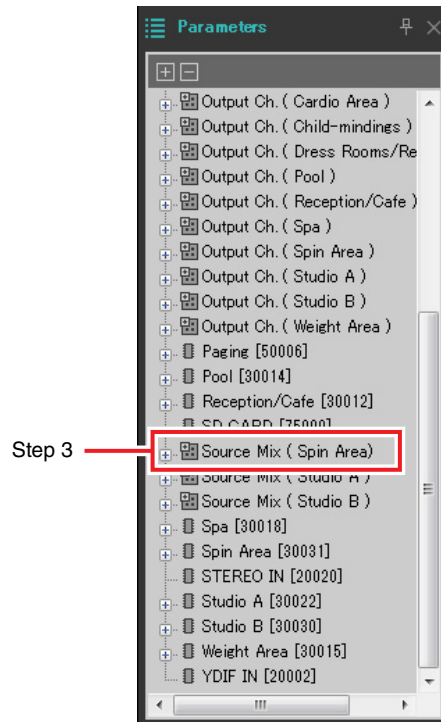

3. Since the level of the background music in the Spin Area is adjusted by Source Mix (Spin Area) “Fader(4),” open “Parameters” area [Source Mix (Spin Area)] → [Fader(4)].

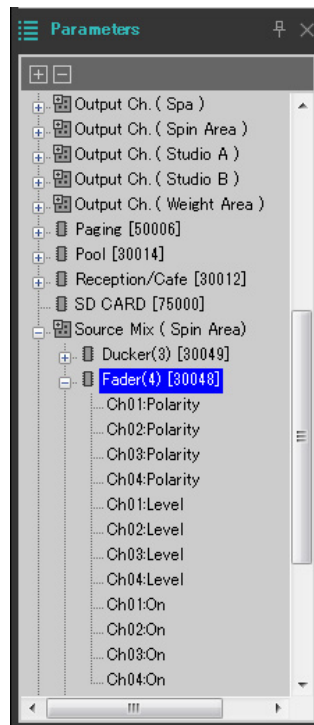

4. Click [Ch03:Level]; then hold down <Ctrl> and click [Ch04:Level].

By clicking while you hold down <Ctrl>, you can select multiple items.

To select multiple adjacent parameters, click the first parameter, then hold down <Shift> and click the last parameter.

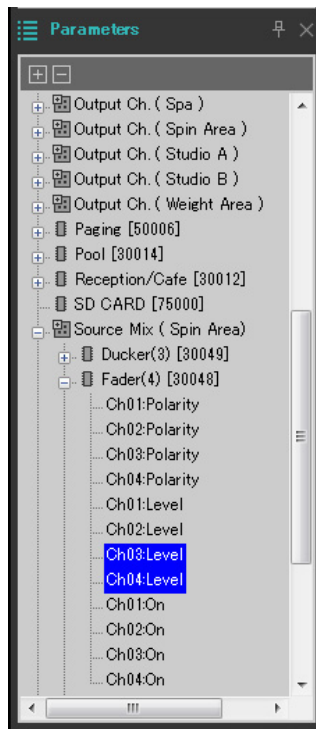

5. Right-click, and choose [Add to Parameter Link Group] → [Add New Group].

A dialog box opens, allowing you to specify a parameter link group name.

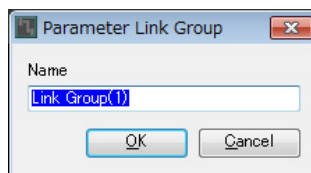

6. Enter [Spin Area BGM LEVEL], and click the [OK] button.

In the “Parameter Link Group” area, a [Spin Area BGM LEVEL] group is created, and the Link Master editor opens.

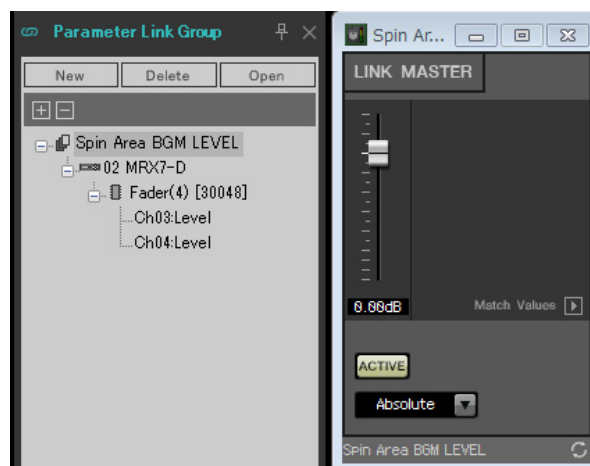

- 7.** In the Link Master editor’s combo box, choose [Absolute].
- 8.** In Source Mix (Spin Area), double-click “Fader(4).”
The “Fader(4)” component editor opens.
- 9.** Operate the fader in the Link Master editor, and verify that the faders of channels 3 and 4 in the “Fader(4)” component editor are linked.
- 10.** Click the [x] buttons located in the upper right of the Link Master editor and the “Fader(4)” component editor to close the editor and the component editor.

Repeat steps 2 through 10 to create the following parameter link groups.

Parameter link group name	Component	Parameter	Setting of the Link Master editor’s combo box
Spin Area BGM ON	[Source Mix (Spin Area)] → [Fader(4)]	Ch03:On	Equal
		Ch04:On	
Spin Area Master LEVEL	[Output Ch. (Spin Area)] → [Fader(14)]	Ch01:Level	Absolute
		Ch02:Level	
Spin Area Master ON	[Output Ch. (Spin Area)] → [Fader(14)]	Ch01:On	Equal
		Ch02:On	
Studio A BGM LEVEL	[Source Mix (Studio A)] → [Fader(2)]	Ch03:Level	Absolute
		Ch04:Level	
Studio A BGM ON	[Source Mix (Studio A)] → [Fader(2)]	Ch03:On	Equal
		Ch04:On	
Studio A Master LEVEL	[Output Ch. (Studio A)] → [Fader(12)]	Ch01:Level	Absolute
		Ch02:Level	
Studio A Master ON	[Output Ch. (Studio A)] → [Fader(12)]	Ch01:On	Equal
		Ch02:On	
Studio B BGM LEVEL	[Source Mix (Studio B)] → [Fader(3)]	Ch03:Level	Absolute
		Ch04:Level	
Studio B BGM ON	[Source Mix (Studio B)] → [Fader(3)]	Ch03:On	Equal
		Ch04:On	
Studio B Master LEVEL	[Output Ch. (Studio B)] → [Fader(13)]	Ch01:Level	Absolute
		Ch02:Level	
Studio B Master ON	[Output Ch. (Studio B)] → [Fader(13)]	Ch01:On	Equal
		Ch02:On	

This completes parameter link group settings.

Making DCP settings

Here you'll assign parameters to the DCP1V4S control panels that are located in each area, so that the parameters can be controlled by the switches and knobs of the control panels.

We'll assign the following parameters to the switches and knobs. The assignment procedure is described later.

Area	Switch/Knob	Component that includes the parameter to be assigned	Parameter
Reception/Cafe	Switch 1	Reception/Cafe's Source Selector	1
	Switch 2		2
	Switch 3		3
	Switch 4		4
	Knob	Fader	Channel 1 level
Cardio Area	Switch 1	Cardio Area's Source Selector	1
	Switch 2		2
	Switch 3		3
	Switch 4		4
	Knob	Fader	Channel 2 level
Pool	Switch 1	Pool's Source Selector	1
	Switch 2		2
	Switch 3		3
	Switch 4		4
	Knob	Fader	Channel 3 level
Weight Area	Switch 1	Weight Area's Source Selector	1
	Switch 2		2
	Switch 3		3
	Switch 4		4
	Knob	Fader	Channel 4 level
Child-mindings	Switch 1	Child-mindings' Source Selector	1
	Switch 2		2
	Switch 3		3
	Switch 4		4
	Knob	Fader	Channel 5 level
Dress Rooms/ Rest Rooms	Switch 1	Dress Rooms/Rest Rooms' Source Selector	1
	Switch 2		2
	Switch 3		3
	Switch 4		4
	Knob	Fader	Channel 6 level
Spa	Switch 1	Spa's Source Selector	1
	Switch 2		2
	Switch 3		3
	Switch 4		4
	Knob	Fader	Channel 7 level

Switch 4 of each control panel is used when background music is not desired.

Here we explain how to assign parameters to the Reception/Cafe DCP1V4S's switch 1 (source select) and knob (parameter). Although in this example we explain the method of holding down <Ctrl> and dragging parameters from the component editor, you can also hold down <Ctrl> and drag and drop from the "Parameters" area.

1. Select [Controller] menu → [Digital Control Panel].

The “Digital Control Panel” dialog box opens.

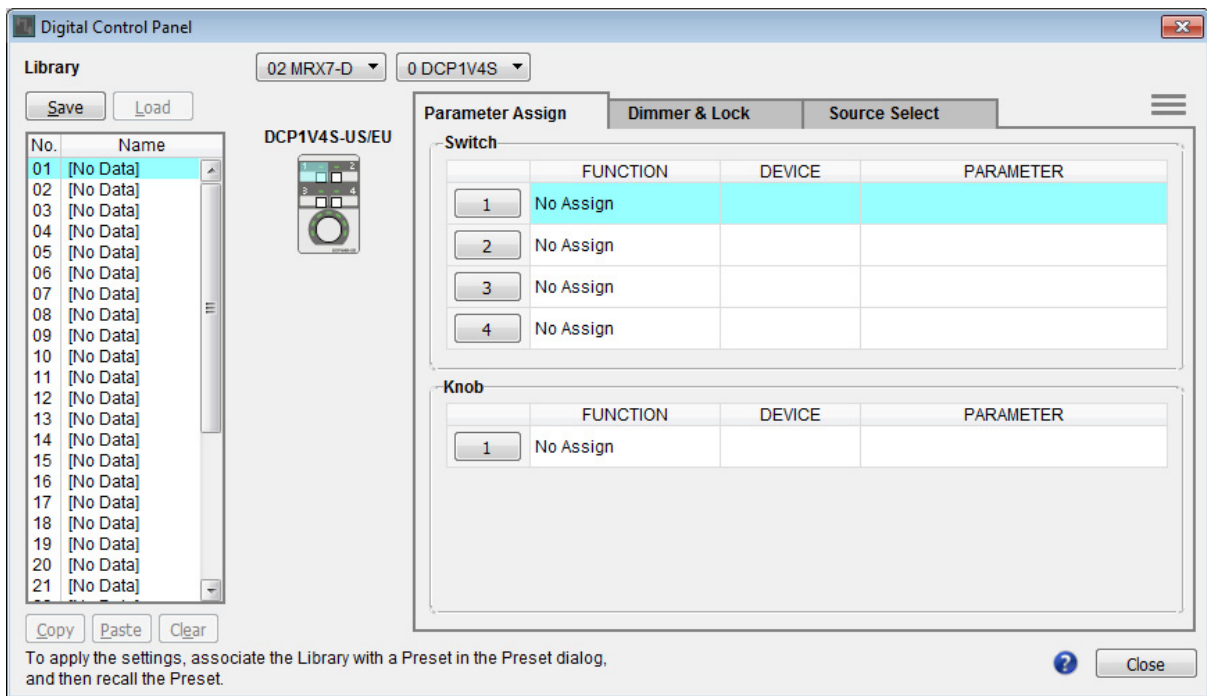

2. Double-click the “Fader” component.

The “Fader” component editor opens.

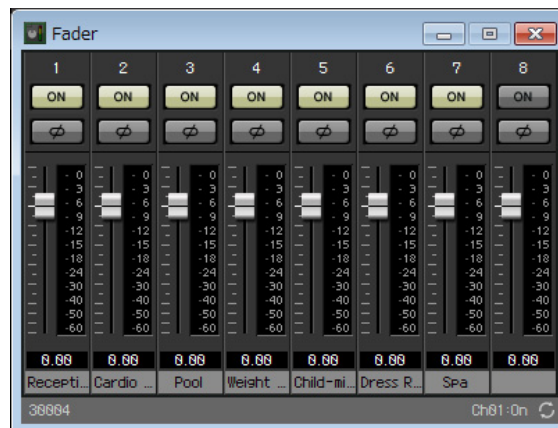

3. In the “Digital Control Panel” dialog box, click the “Source Select” tab.

The Source Select screen appears.

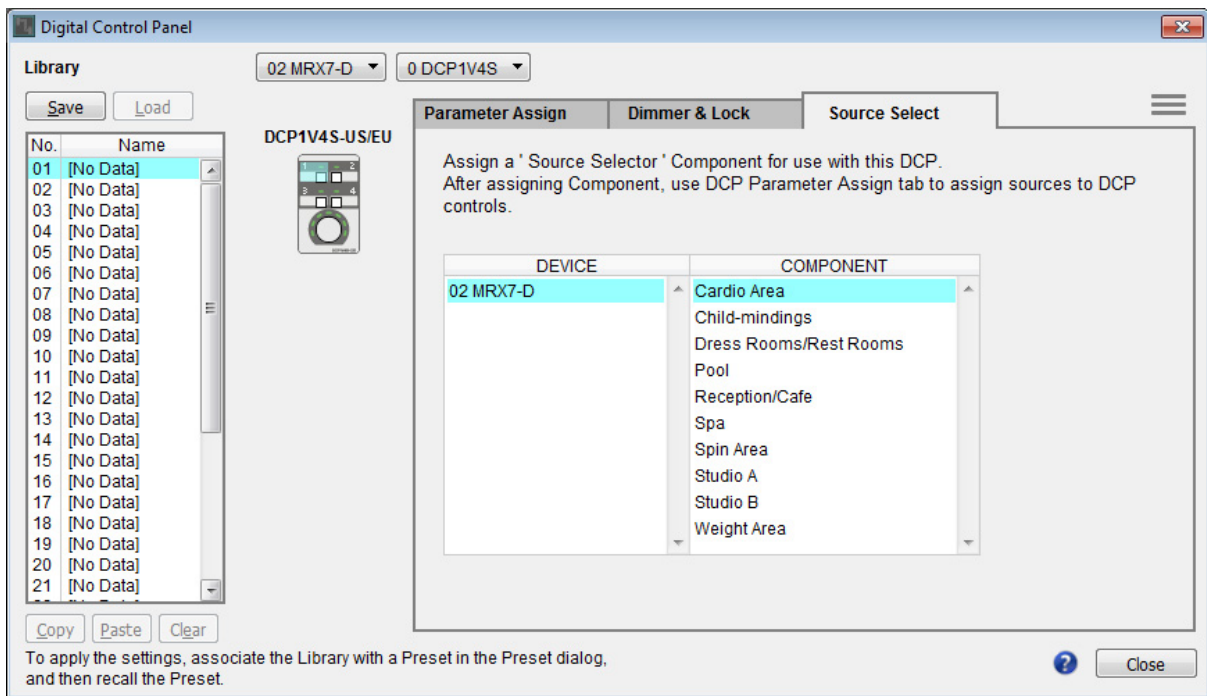

4. In [COMPONENT], select [Reception/Cafe].

The Source Selector component of Reception/Cafe is assigned to PARAMETER 1 of MRX Source Select.

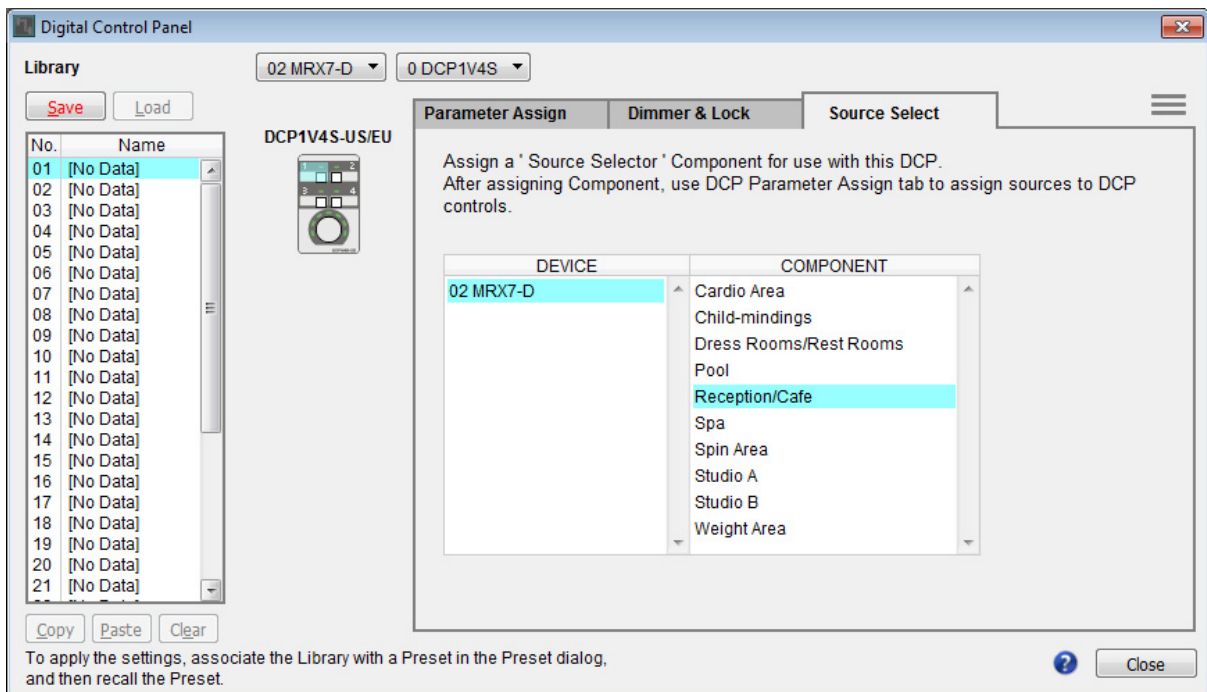

5. Click the “Parameter Assign” tab.

The Parameter Assign screen appears.

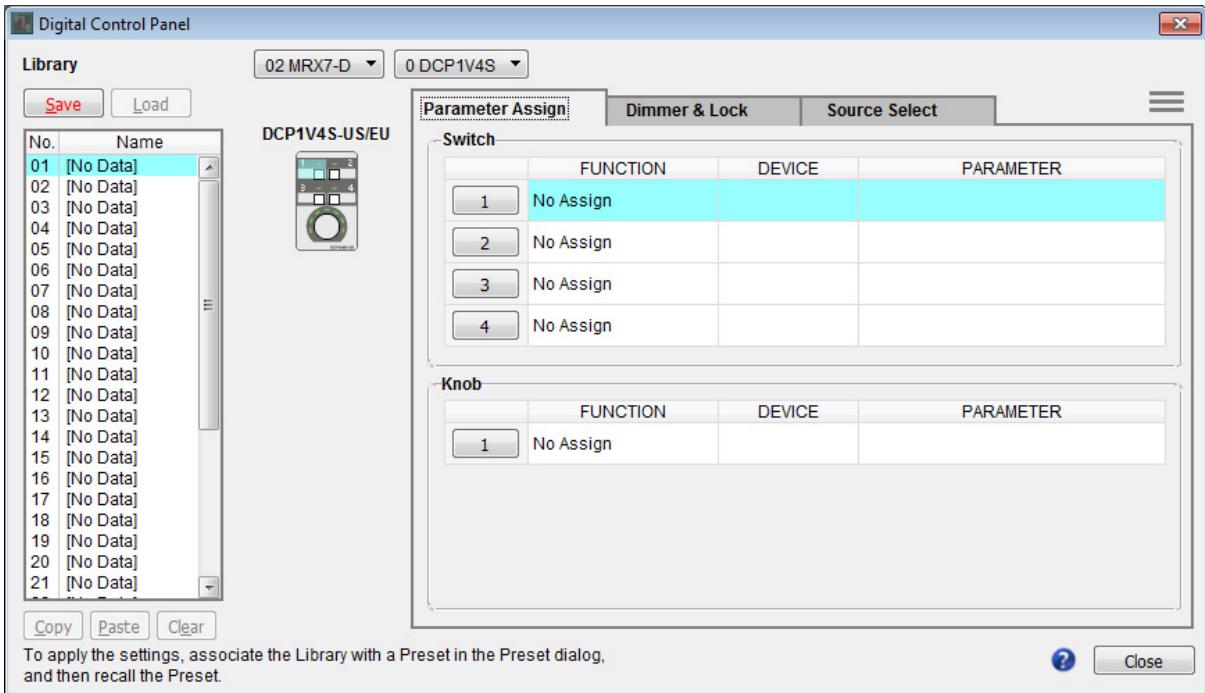

6. Click the “Switch” [1] button.

The “Settings” dialog box appears.

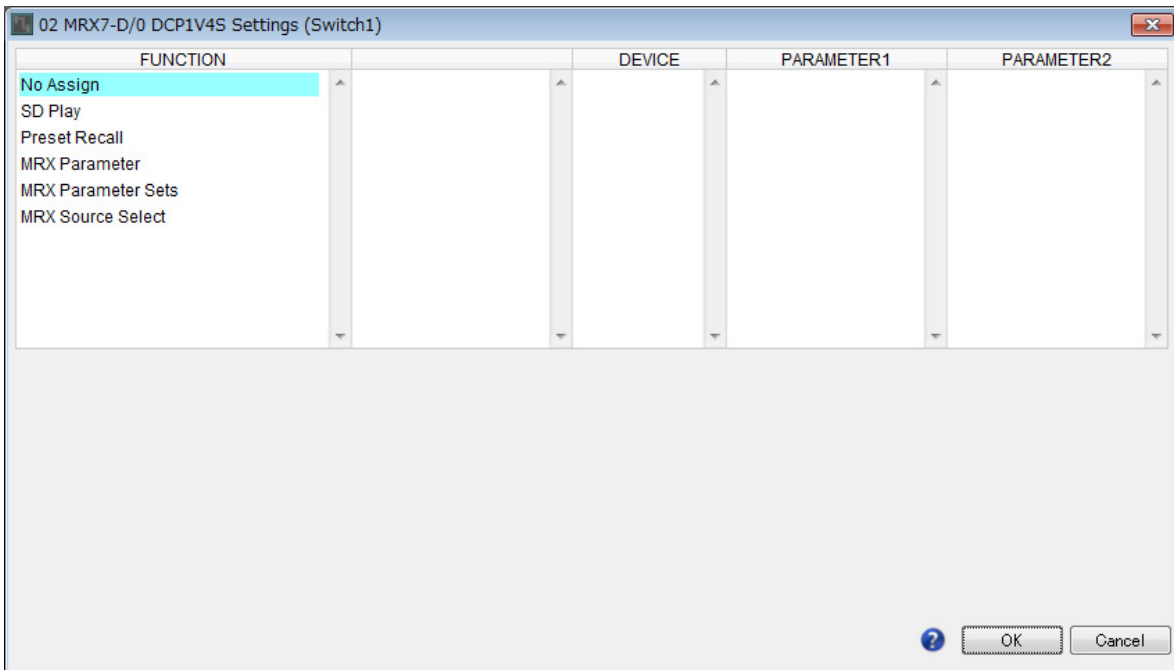

7. In “FUNCTION,” click [MRX Source Select].

The [MRX Source Select] registration screen appears.

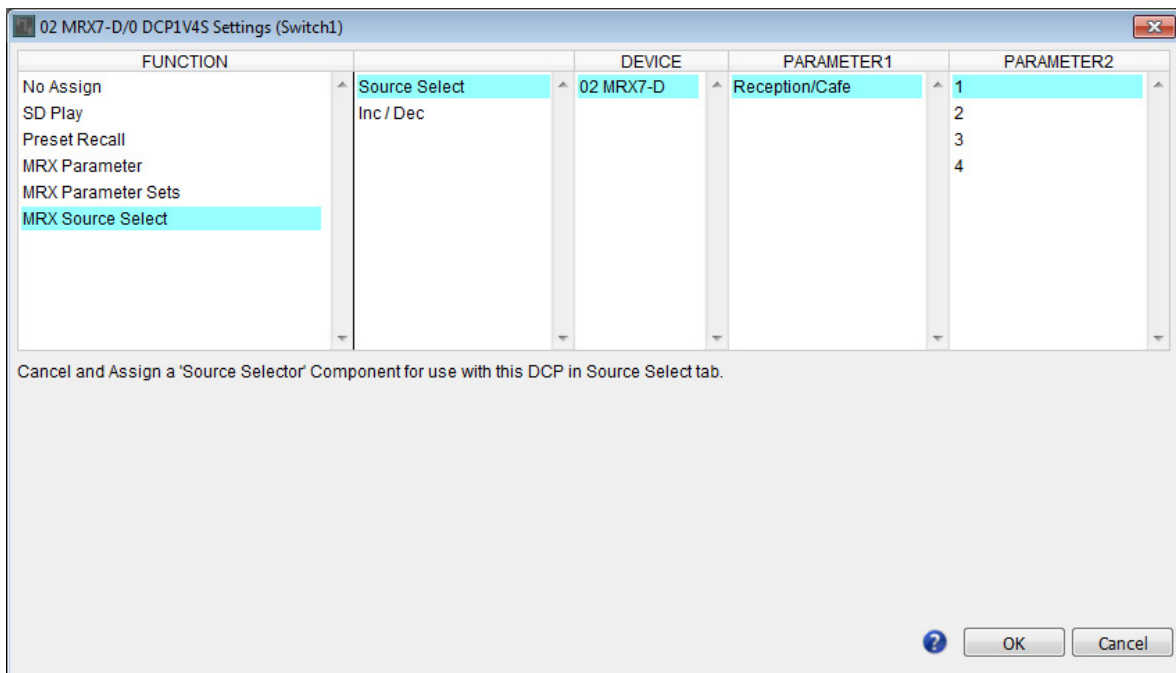

8. In “PARAMETER2,” choose [1].

When you press the DCP’s switch 1, the Work out BGM1 audio will play.

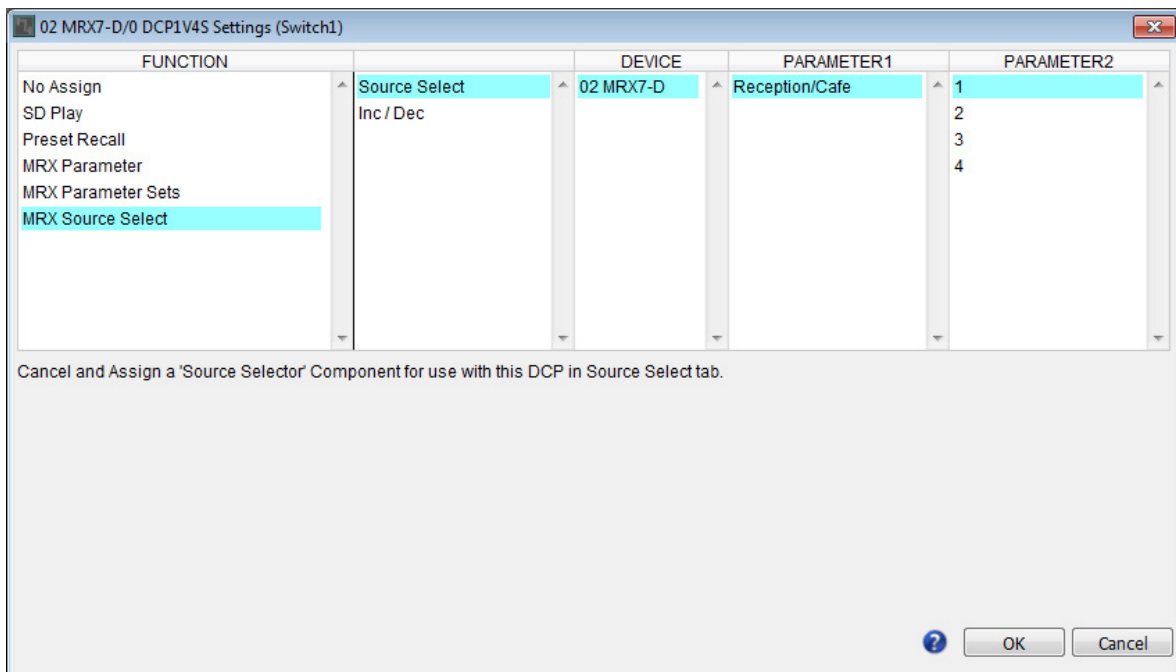

9. Click the [OK] button.

The “Digital Control Panel” dialog box appears, with Reception/Cafe’s Source Selector [1] button assigned.

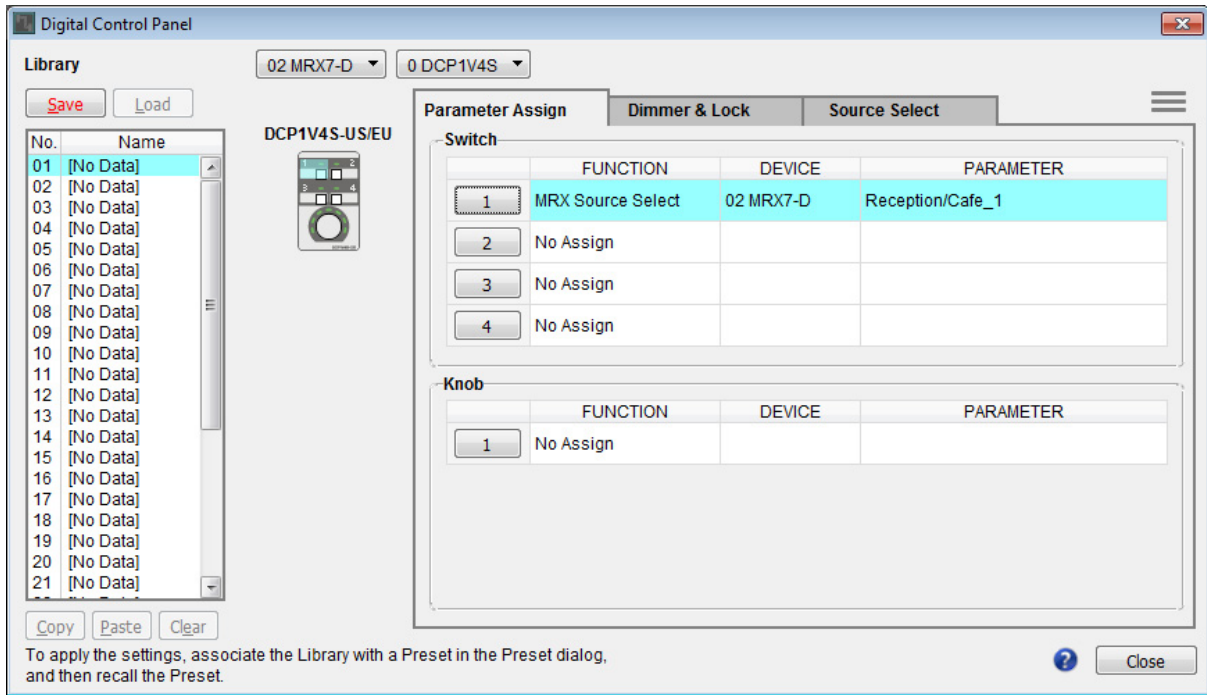

10. Assign other parameters to the switches as described in steps 6 through 9.

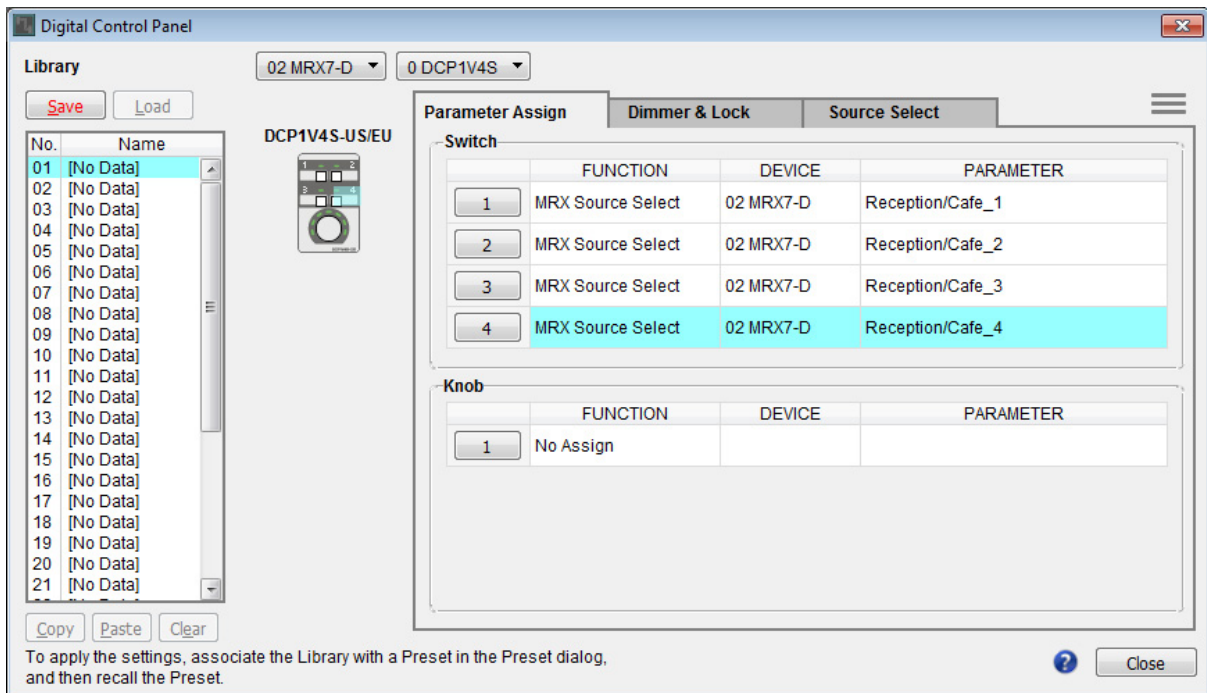

11. Click the “Knob” [1] button.

The “Settings” dialog box appears.

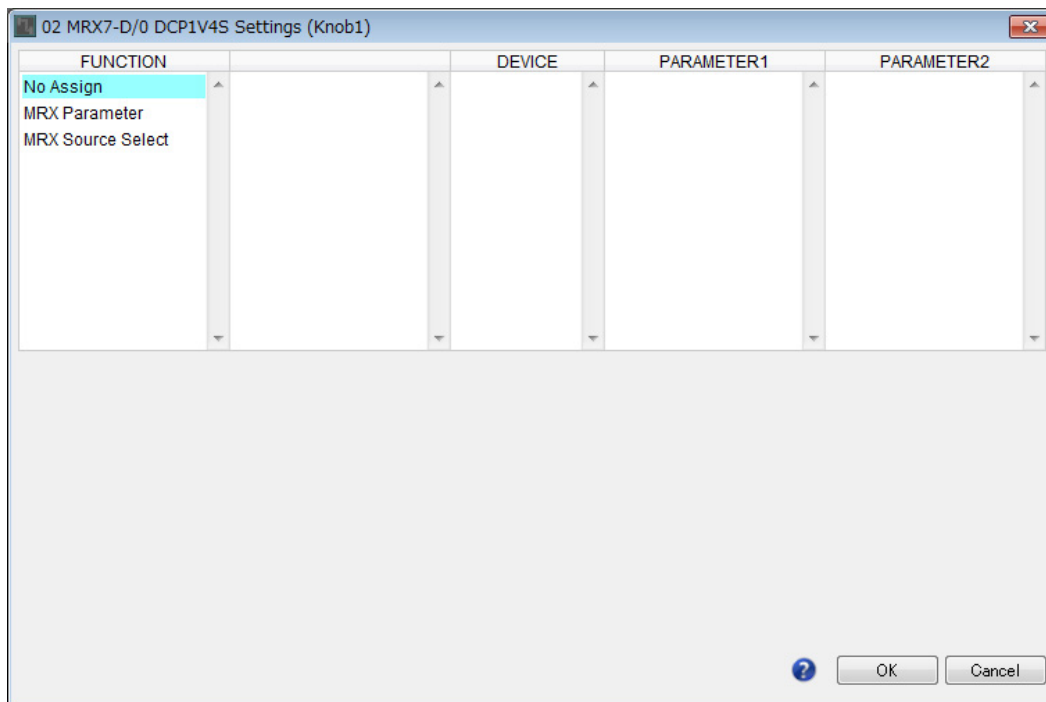
**12. In “FUNCTION,” click [MRX Parameter].**

The [MRX Parameter] registration screen appears.

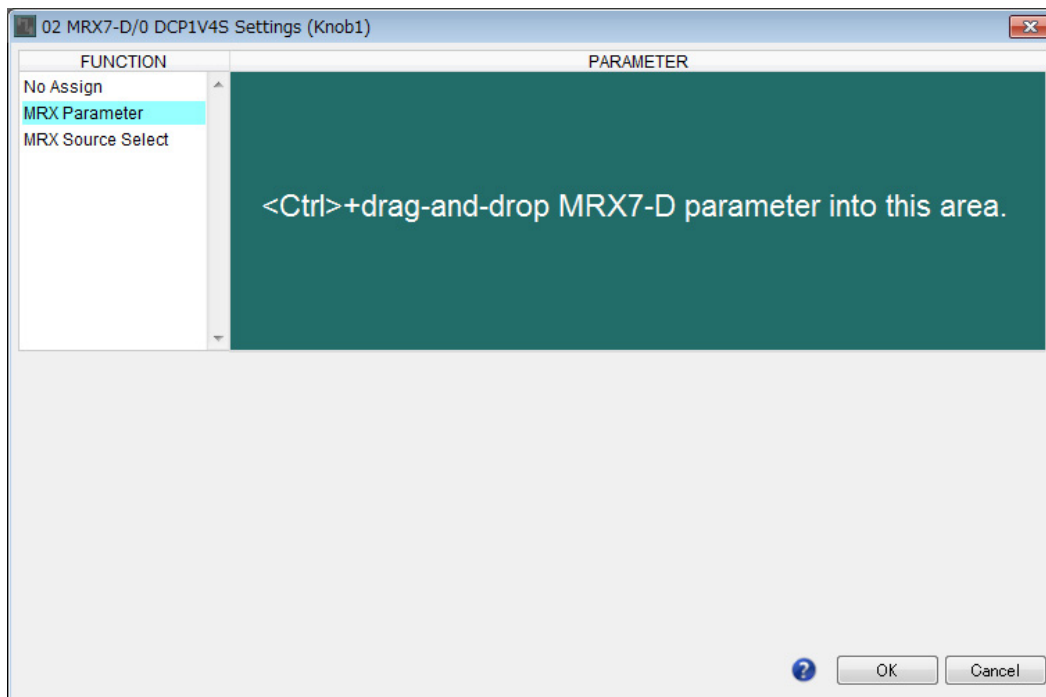

13. While holding down the <Ctrl>, drag and drop the channel 1 fader of the “Fader” component editor into the “PARAMETER” area of the “Settings” dialog box.

The fader of “Fader” channel 1 is registered.

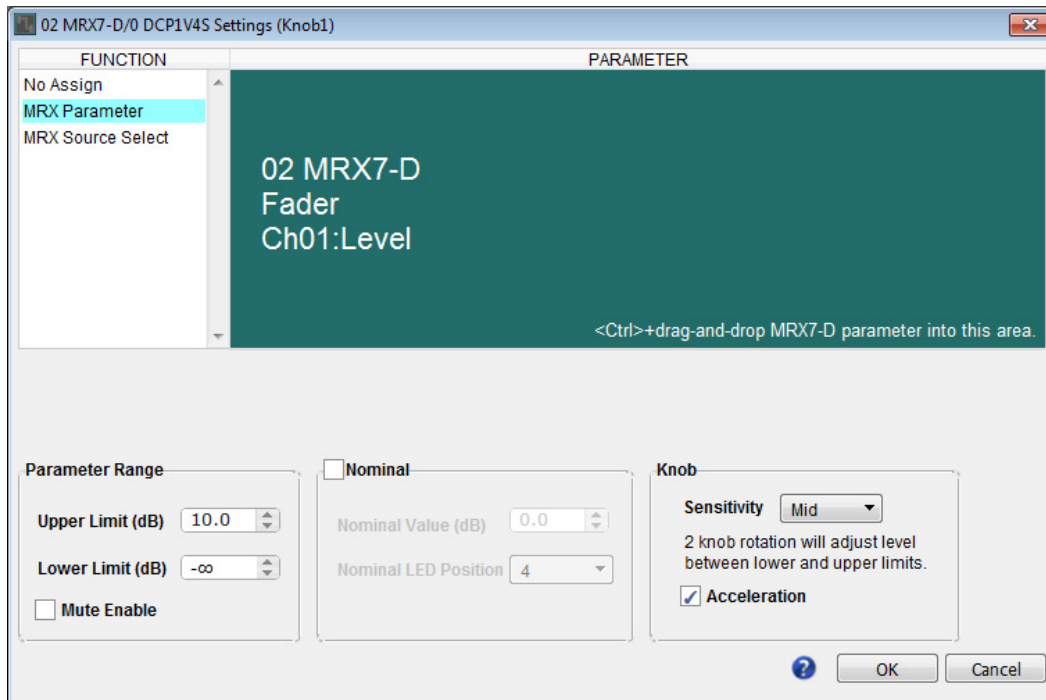

14. Click the [OK] button.

The “Digital Control Panel” dialog box appears, with the Fader channel 1 fader assigned to the knob.

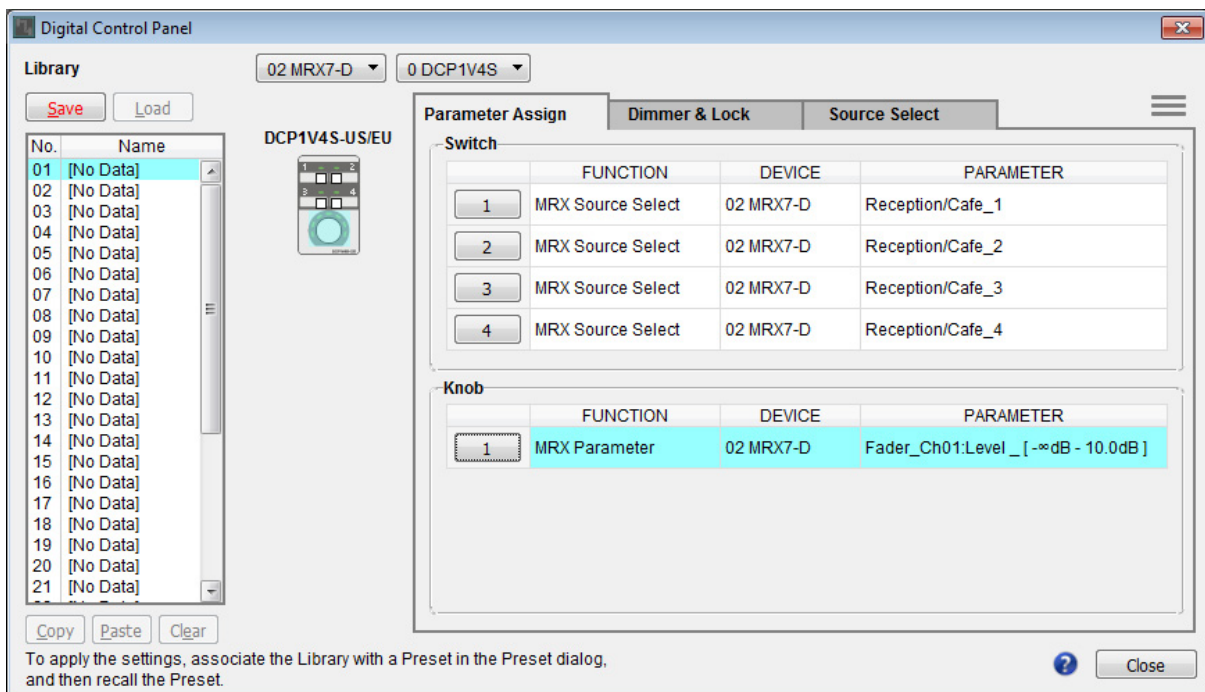

15. Click “Library” No. 01, and then click the [Save] button.

The “Save Library” dialog box appears.

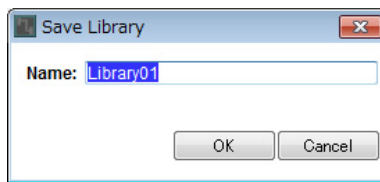

16. Click the [OK] button.

The settings are registered as “Library” No. 01.

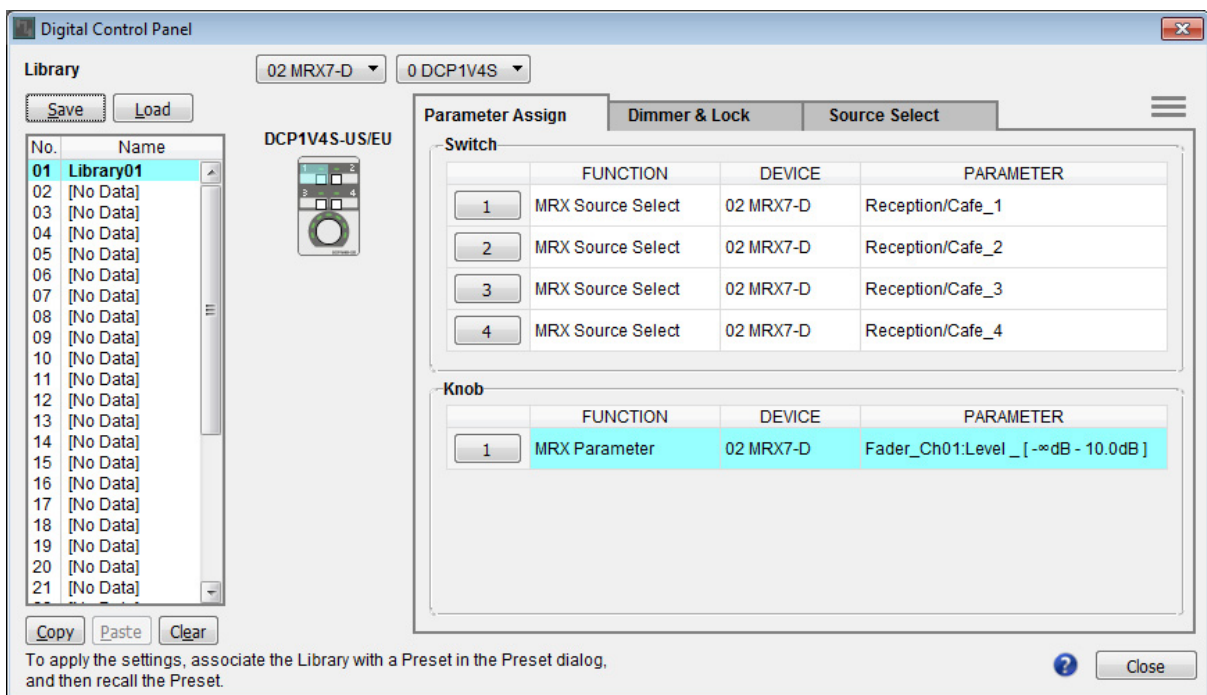

- 17.** In the DCP selection list box, select another DCP unit and make settings for it as described in steps 3 through 16.

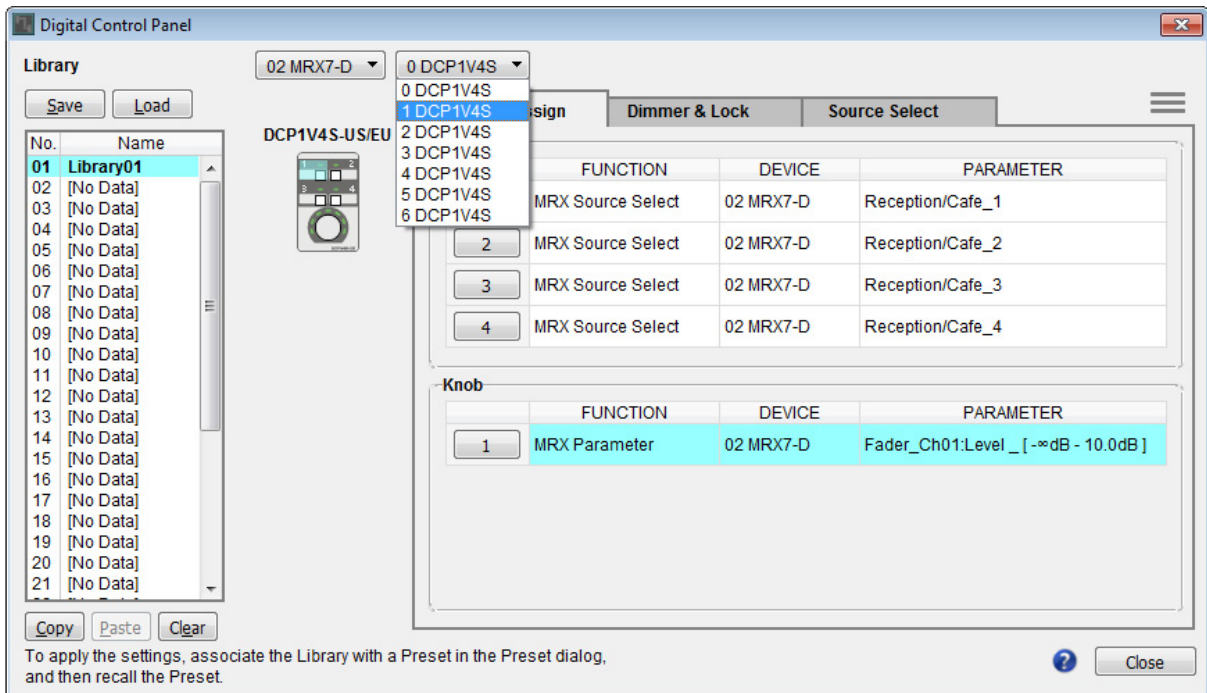

- 18.** When you've made settings for all DCP units, click the [Close] button.

The "Digital Control Panel" dialog box closes.

Making MCP1 settings

Here you'll assign parameters to the MCP1 units located in Studio and Spin Area, so that parameters can be controlled by switches.

We'll assign the following parameters to the switches of the home page. The method of making Source Selector and Fader assignments is essentially the same as for the DCP. The methods for assigning parameter link groups and designing the screen are described later.

Area	Switch	Component that includes the parameter to be assigned	Parameter
Studio A	L1	Studio A's Source Selector	1
	L2		3
	L3	Source Mix (Studio A) Fader (2)	Channel 1 level
	R1	Studio A's Source Selector	2
	R2		4
	R3	Parameter link group's Studio A BGM LEVEL	Link master level
Studio B	L1	Studio B's Source Selector	1
	L2		3
	L3	Source Mix (Studio B) Fader (3)	Channel 1 level
	R1	Studio B's Source Selector	2
	R2		4
	R3	Parameter link group's Studio B BGM LEVEL	Link master level
Spin Area	L1	Spin Area's Source Selector	1
	L2		3
	L3	Source Mix (Spin Area) Fader (4)	Channel 1 level
	R1	Spin Area's Source Selector	2
	R2		4
	R3	Parameter link group's Spin Area BGM LEVEL	Link master level

Each L3 switch is used to adjust the mic level.

We'll explain how to design Studio A's R3 switch (parameter link group) and screen.

1. Choose [Controller] menu → [MCP1].

The “MCP1” dialog box appears.

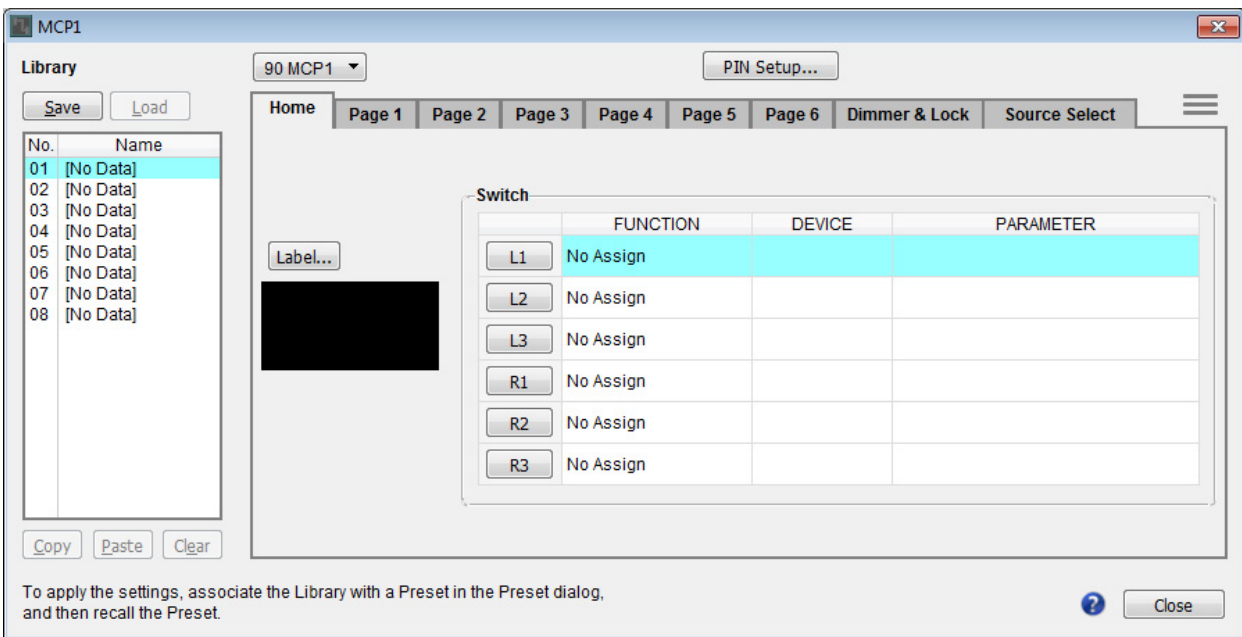

2. In the “Source Select” tab, specify the applicable Source Selector, and then make settings for the L1/2/3 and R1/2 switches.

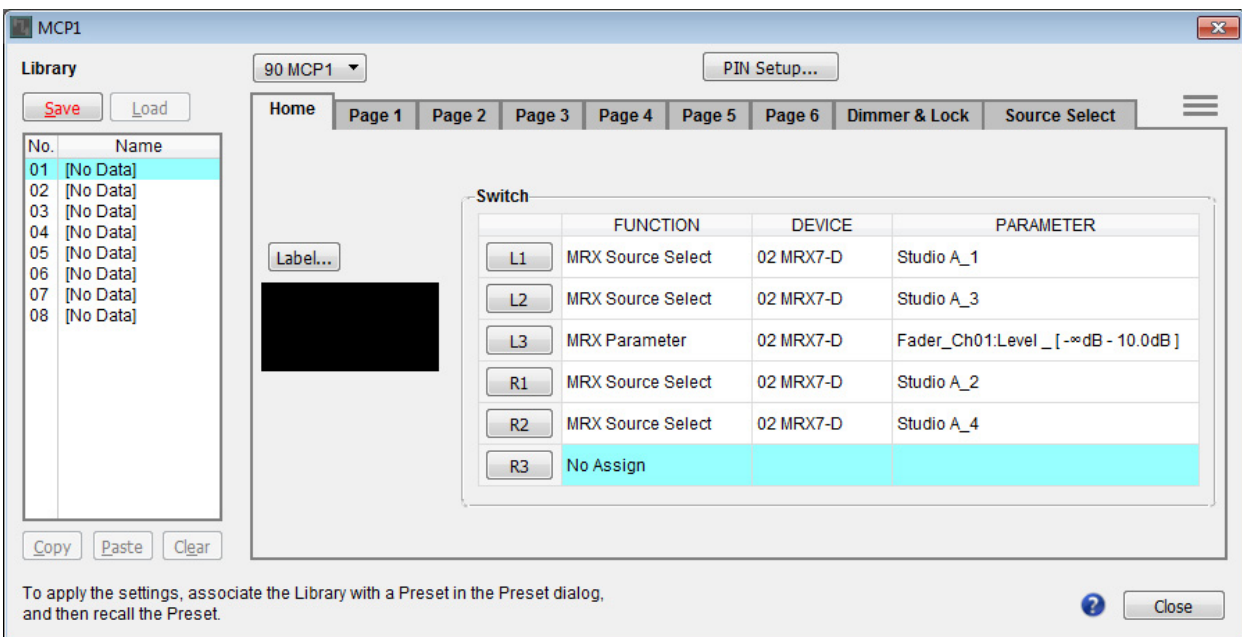

3. Click the “Switch” [R3] button.

The “Settings” dialog box appears.

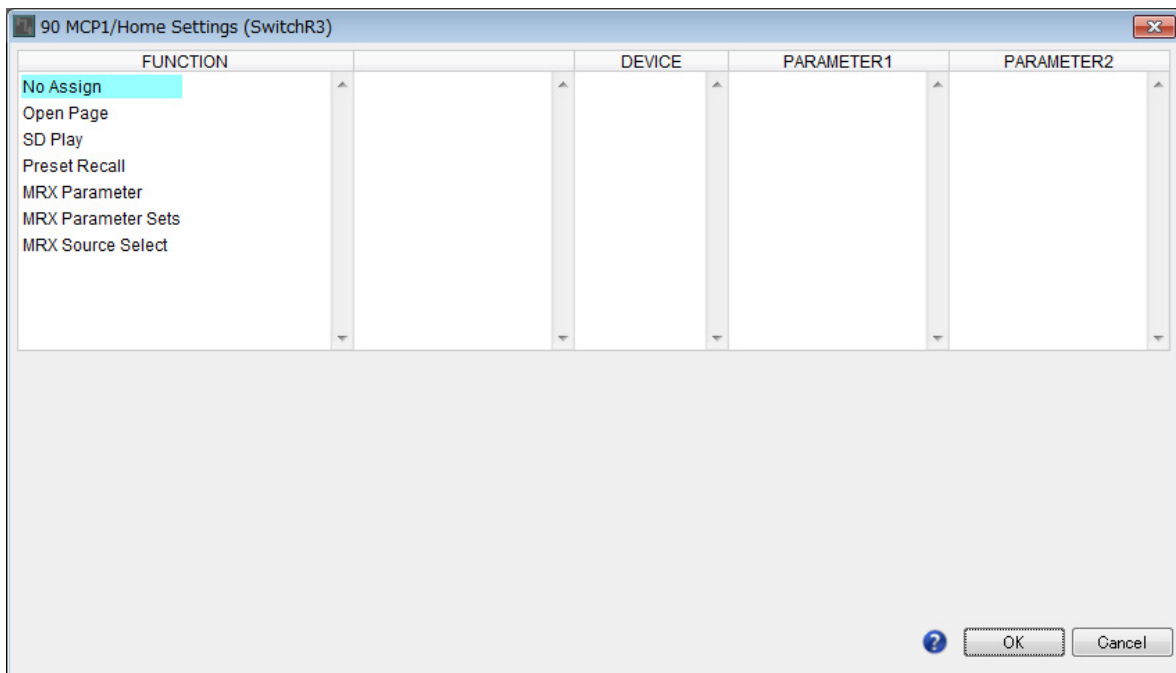

4. In “FUNCTION,” click [MRX Parameter].

The [MRX Parameter] registration screen appears.

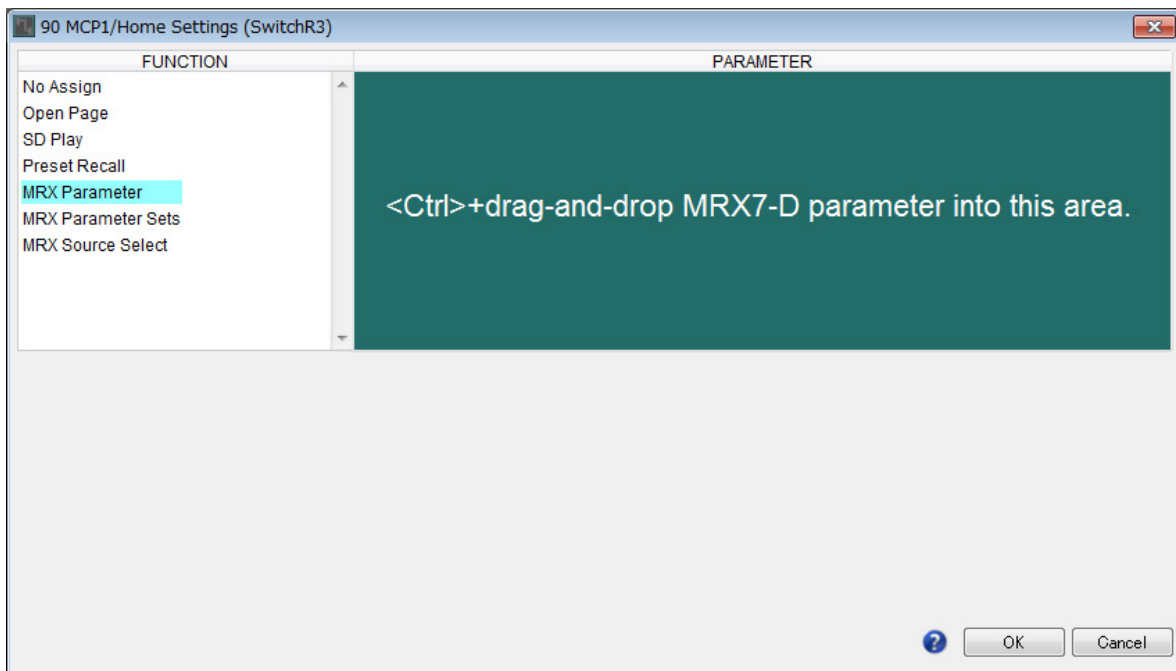

- In the “Parameter Link Group” area, right-click [Studio A Master LEVEL] and choose [Open Link Master].

The Link Master Editor for Studio A Master LEVEL opens.

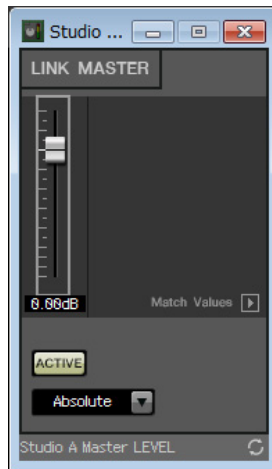

- While holding down <Ctrl>, drag and drop the fader of the Studio A Master LEVEL Link Master editor into the “PARAMETER” area of the “Settings” dialog box.

The fader of the Link Master editor for Studio A Master LEVEL is registered.

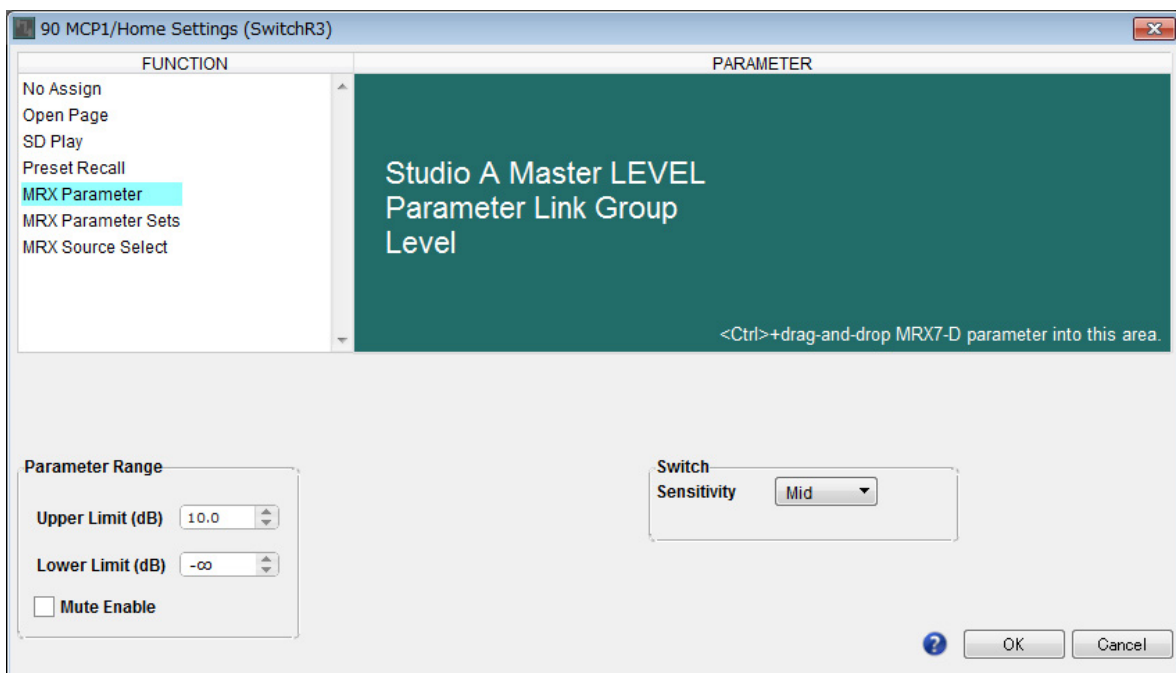

7. Click the [OK] button.

The “MCP1” dialog box appears, with the fader of the Studio A Master LEVEL Link Master editor assigned to the R3 switch.

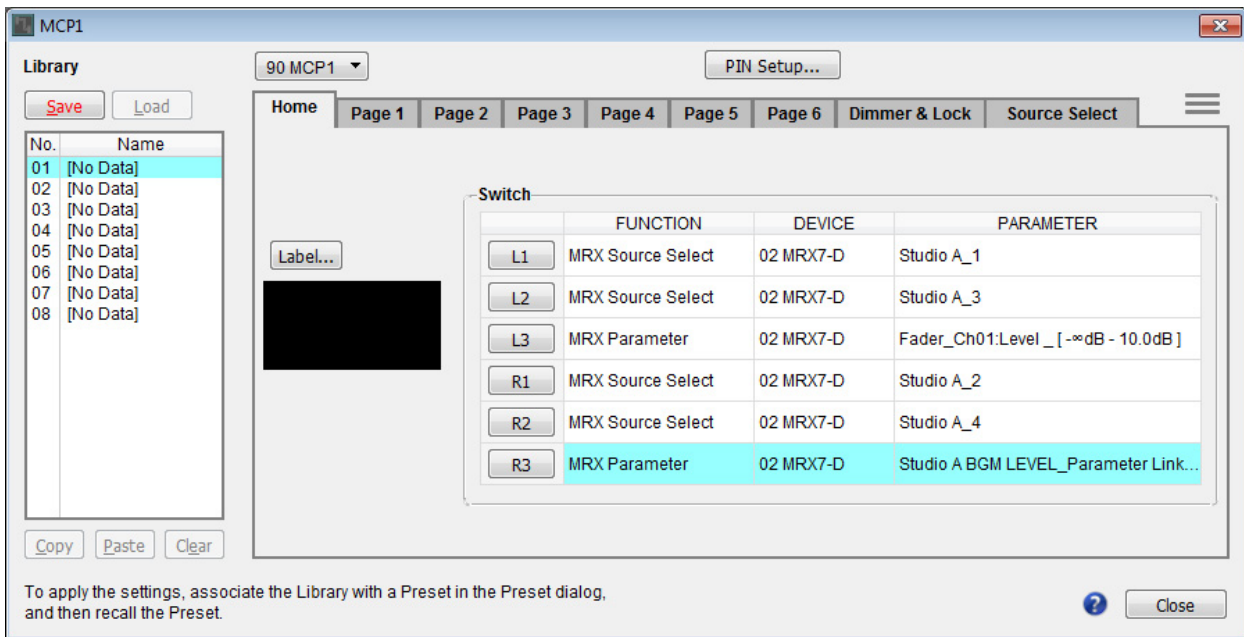

8. To create the screen that will be shown in the MCP1’s display, click the [Label] button.

The “Label” dialog box appears.

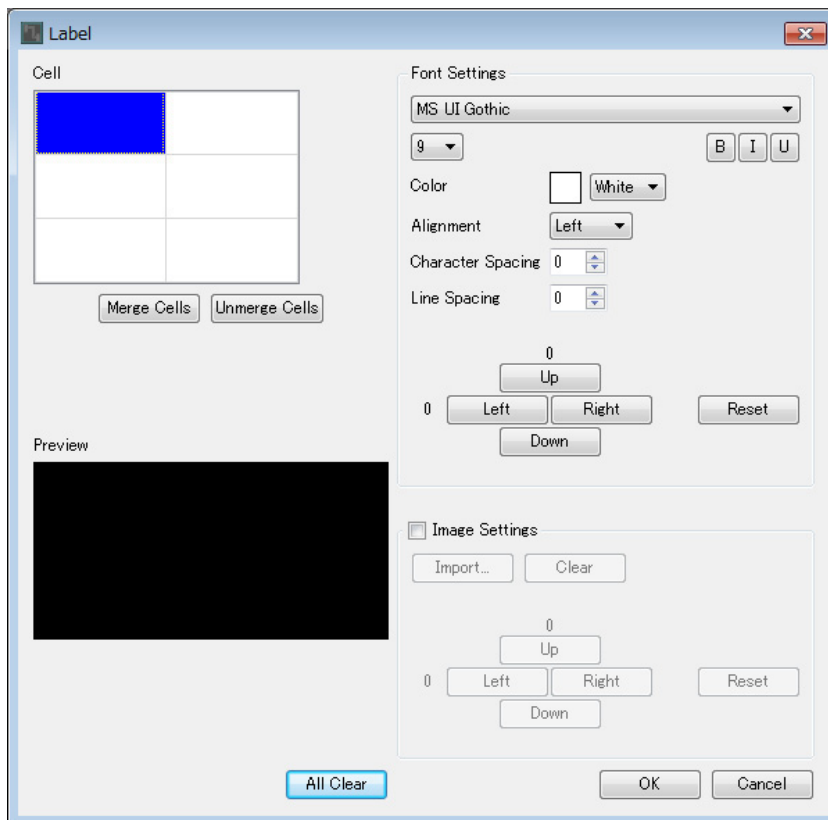

9. Double-click the [Cell] in which you want to enter a character string, making it editable.

You can also select a cell and then press <F2> to make it editable.

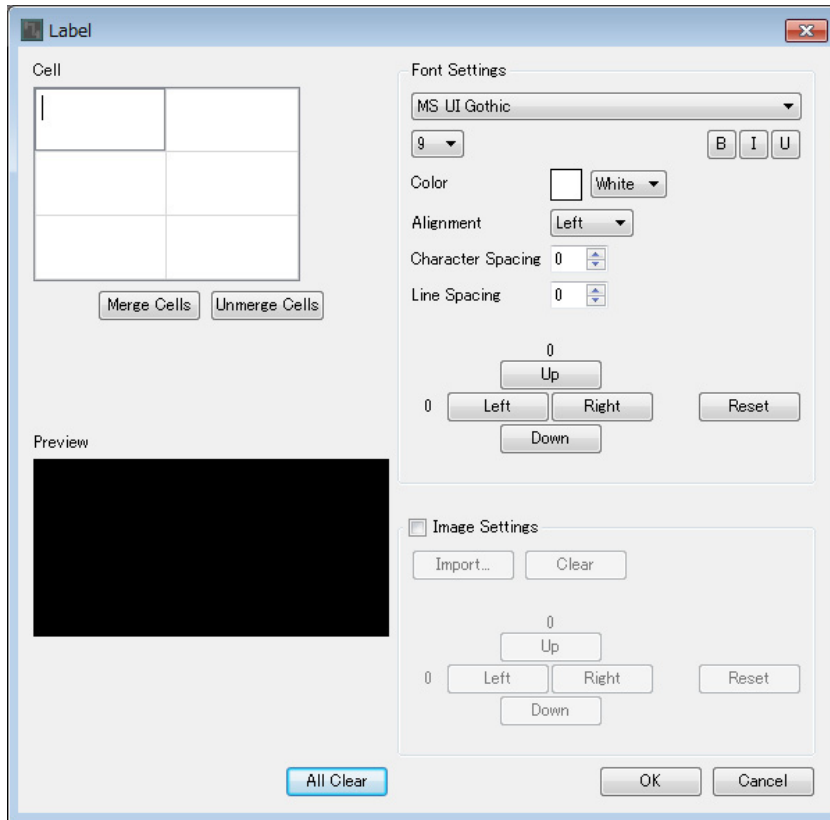

10. Enter a character string.

To start a new line within a cell, hold down <Alt> and press <Enter>.

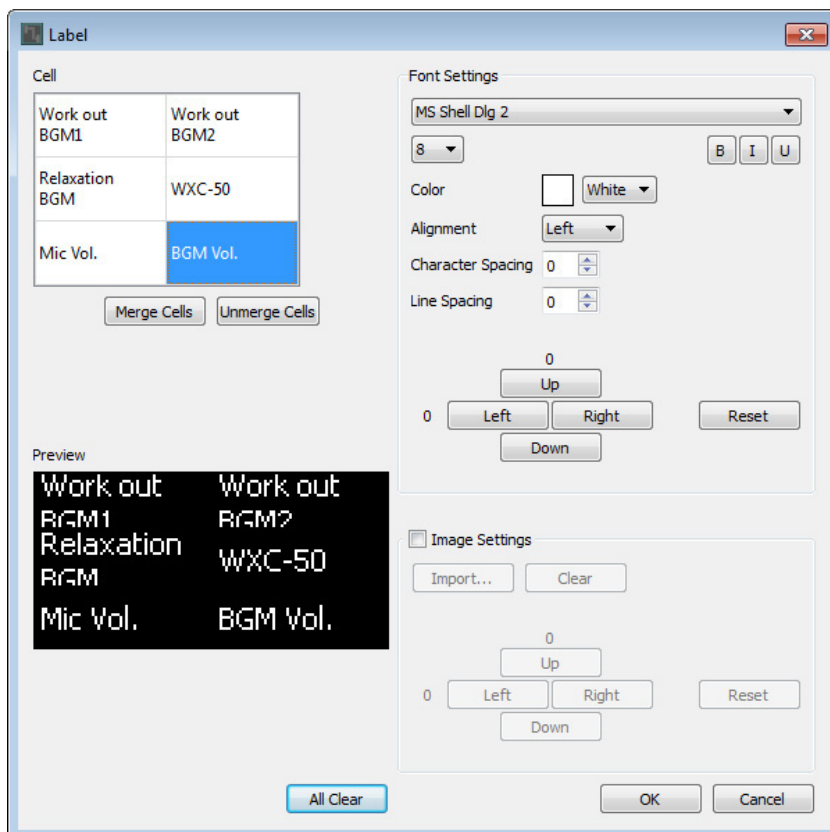

L1	Work out BGM1
L2	Relaxation BGM
L3	Mic Vol.
R1	Work out BGM2
R2	WXC-50
R3	BGM Vol.

- Use [Font Settings] to make adjustments to the display of each cell while watching [Preview] to see the result.

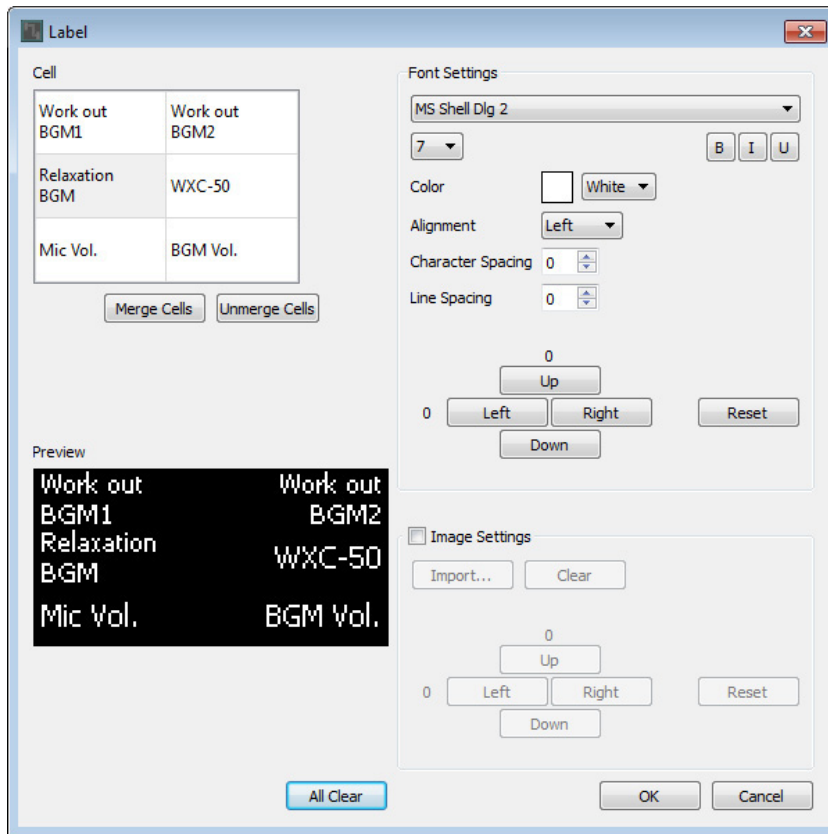

- When you've finished making settings, click the [OK] button.

The "MCP1" dialog box appears with the label preview shown.

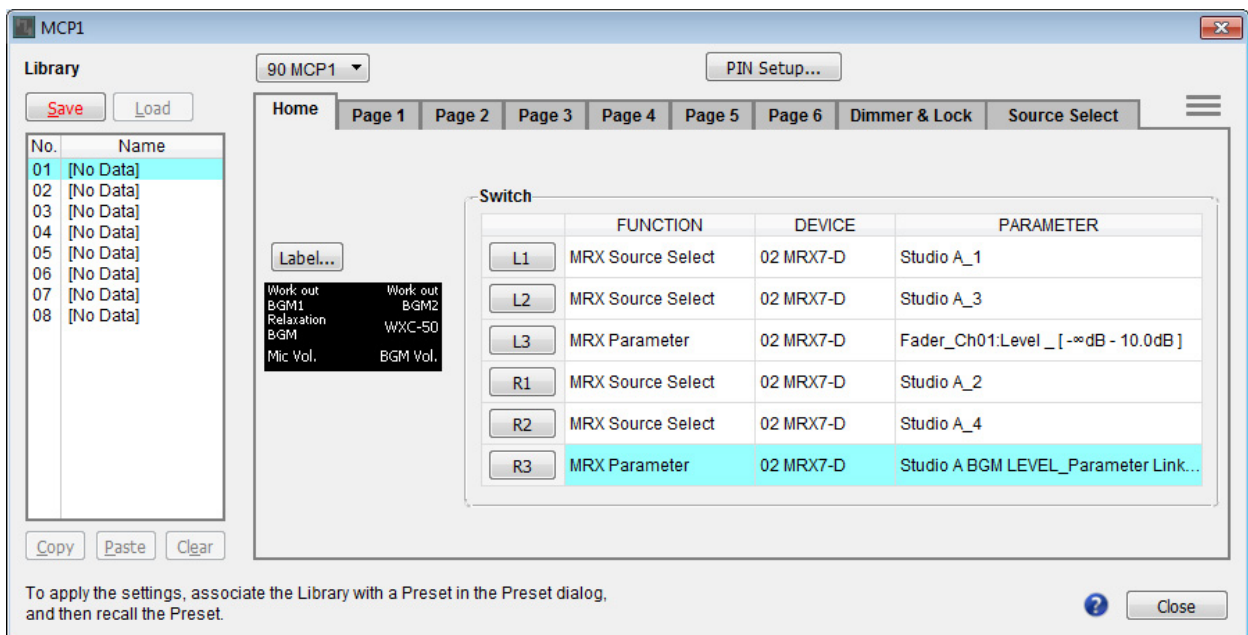

13. Click “Library” No. 01, and then click the [Save] button.

The “Save Library” dialog box appears.

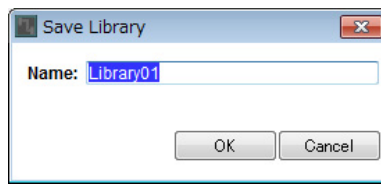

14. Click the [OK] button.

The settings are registered as “Library” No. 01.

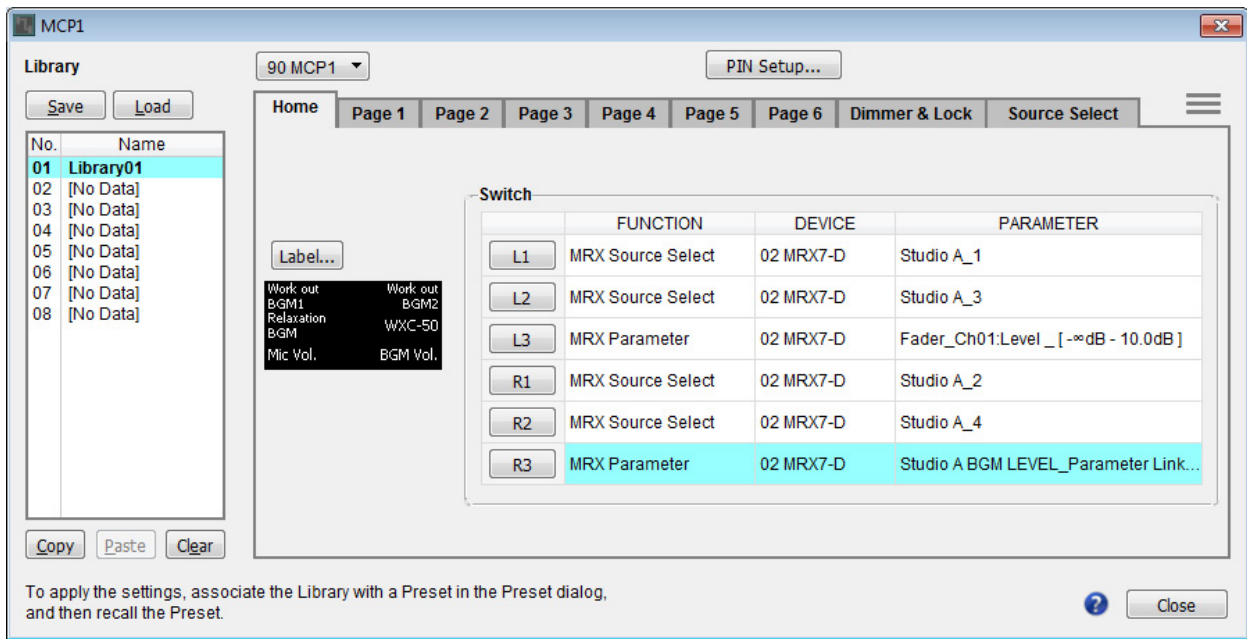

- 15.** In the MCP1 selection list box, select another MCP1 and make settings for it as described in steps 2 through 14.

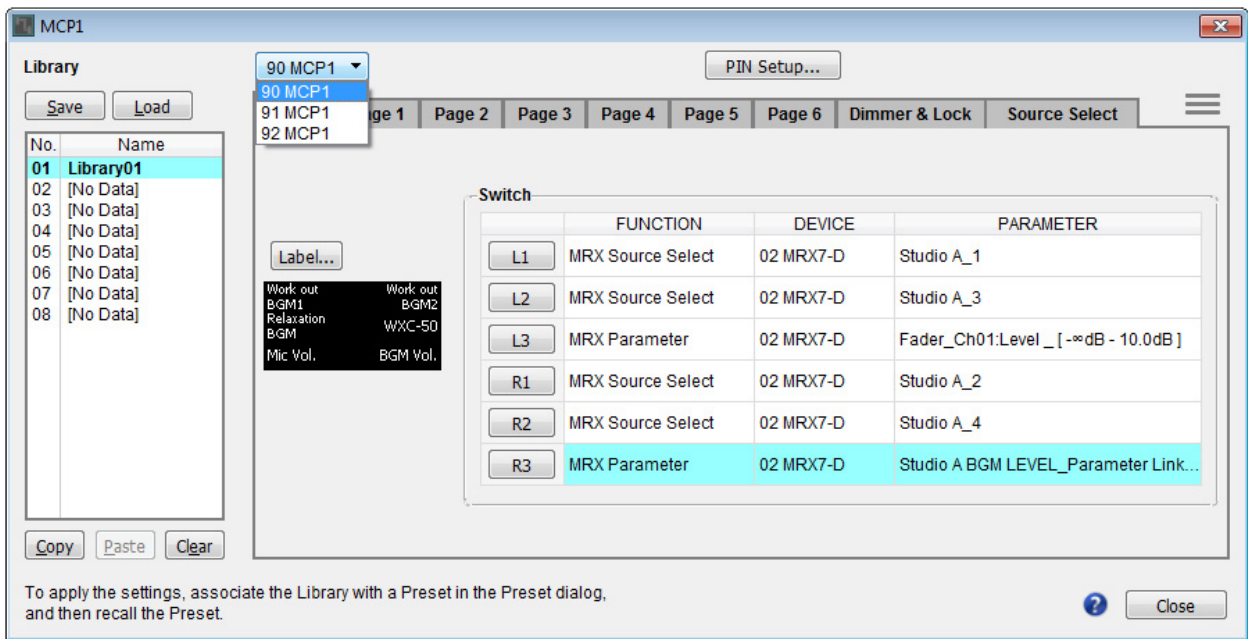

- 16.** When you've made settings for all MCP1 units, click the [Close] button.
The "MCP1" dialog box closes.

Storing a preset

For the MRX, you'll need to specify the preset that is recalled when the unit starts.

1. Click the [Preset] tool button ()

The "Preset" dialog box appears.

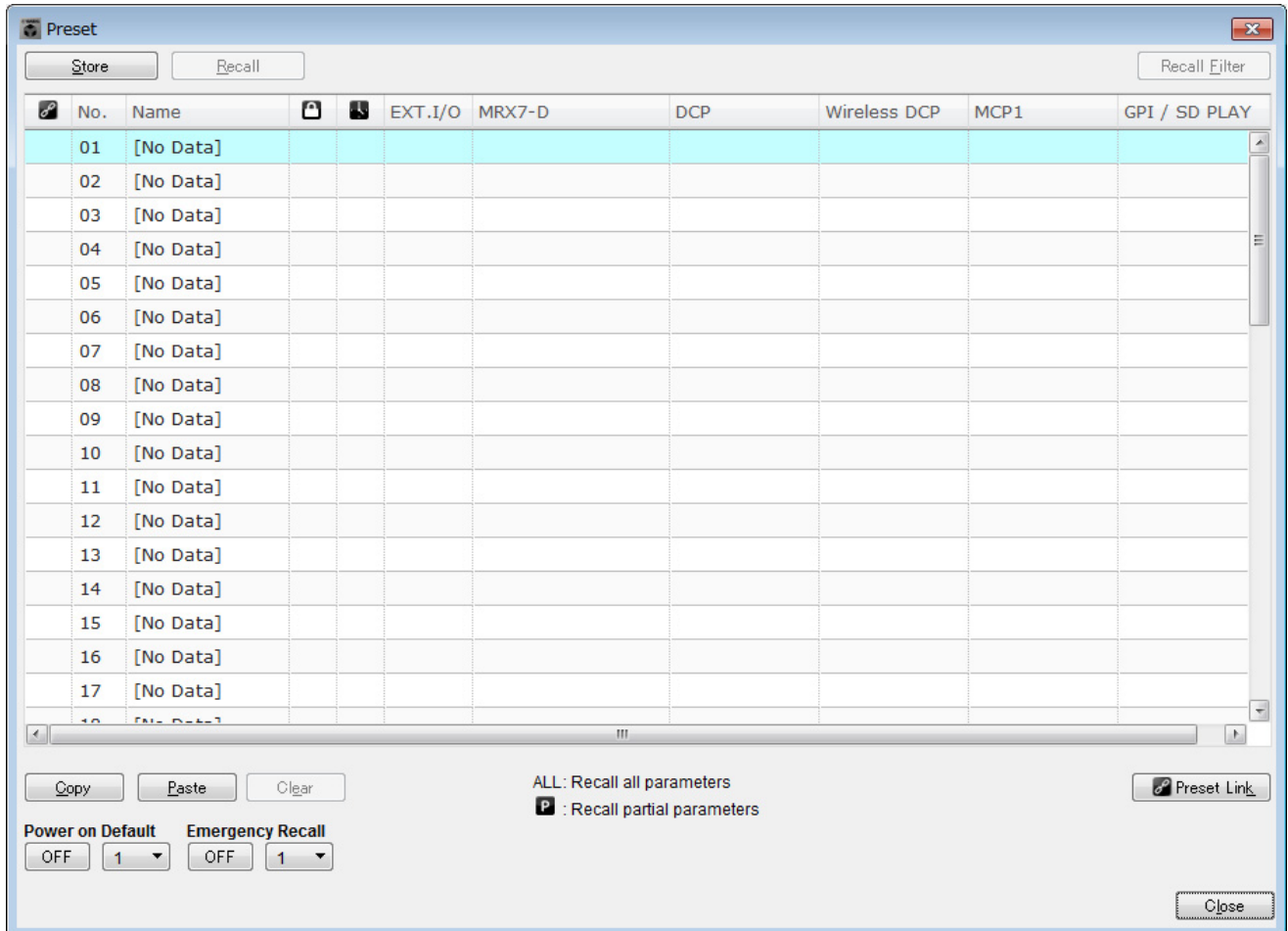

2. Click No. 01, and then click the [Store] button.

The "Store Preset" dialog box appears.

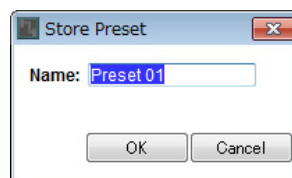

3. Click the [OK] button.

The current state is registered as a preset with the name “Preset 01.”

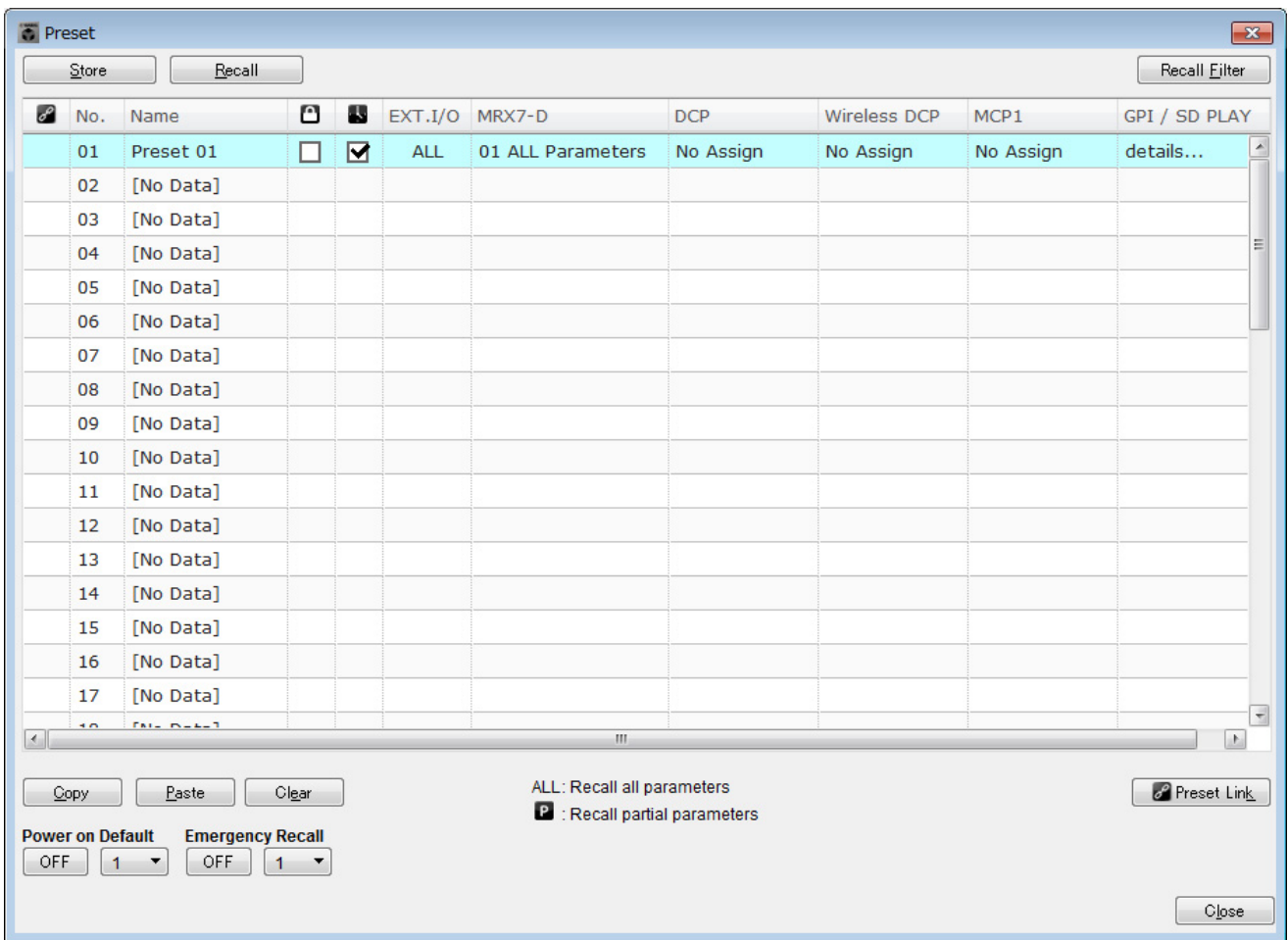

4. In the “DCP” column, double-click the cell that is shown as [No Assign].

The “Settings” dialog box appears.

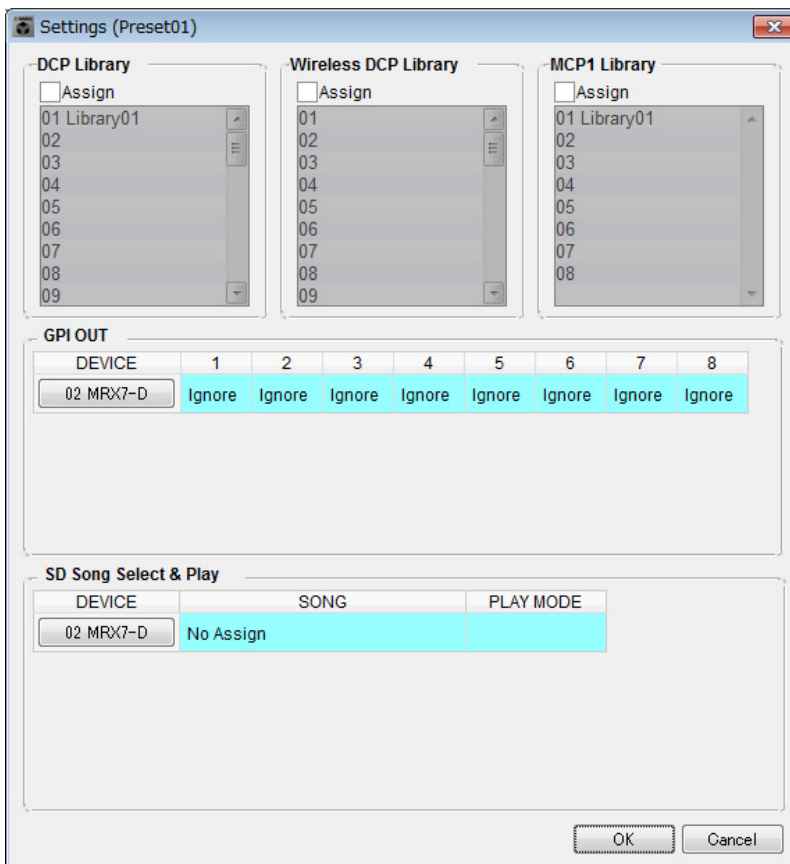

5. Select the [Assign] check boxes for “DCP Library” and “MCP1 Library.”

Now you can select the library items that are recalled when the MRX7-D starts.

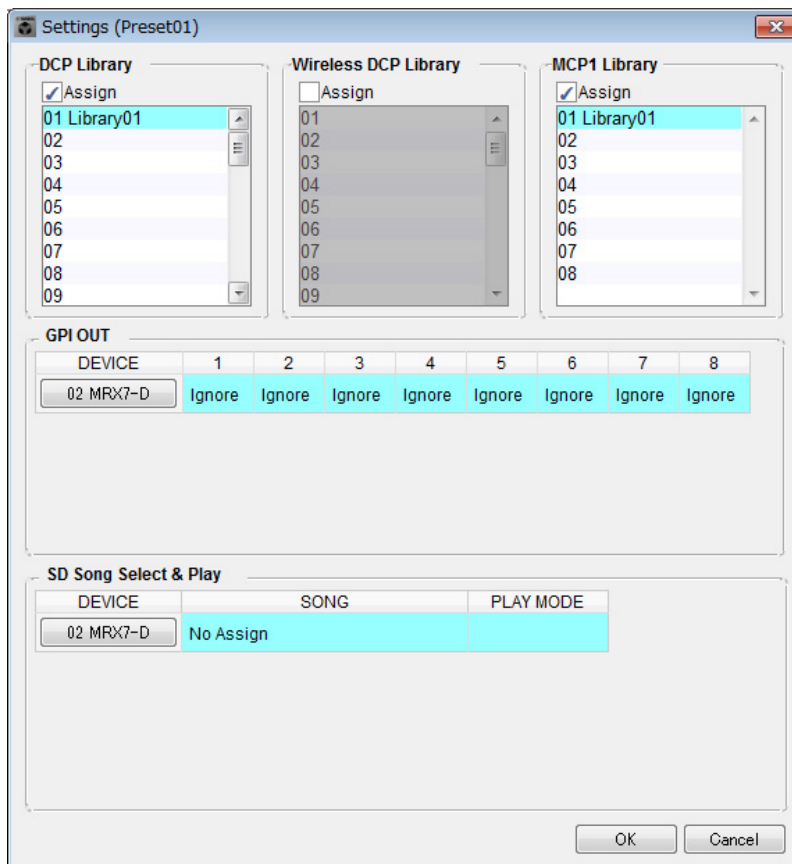

6. Select [01 Library01] for “DCP Library” and for “MCP1 Library,” and click the [OK] button.

The “Preset” dialog box appears, with “01 Library01” assigned to “DCP Library” and “MCP1 Library.”

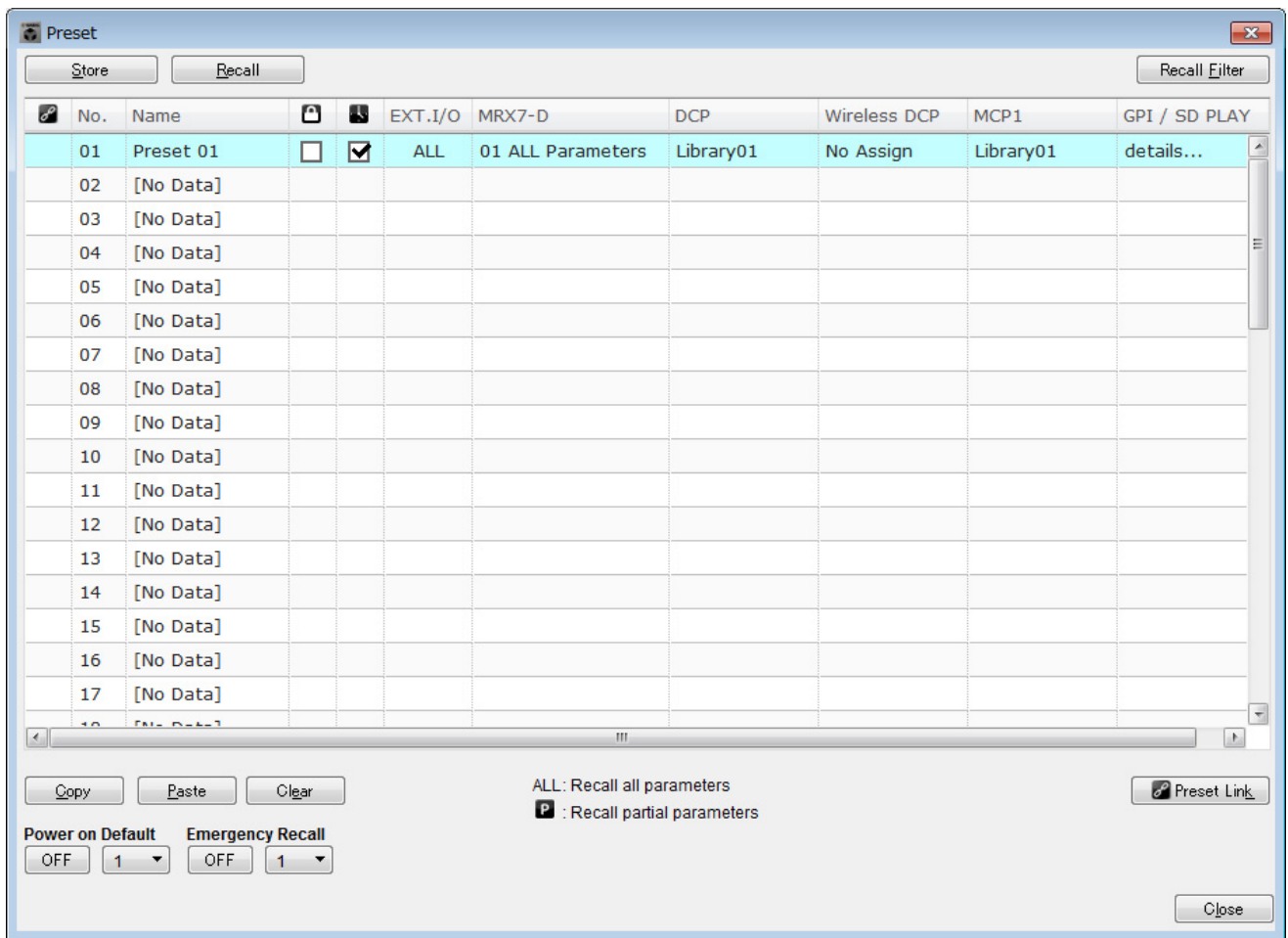

7. Click the [Close] button.

The “Preset” dialog box closes.

Making EXT. I/O settings

Here you'll make settings in MRX Designer for using digital input/output. In this example, you'll make YDIF settings and DANTE settings.

These settings are made using MTX-MRX Editor.

1. Switch the display to MTX-MRX Editor.

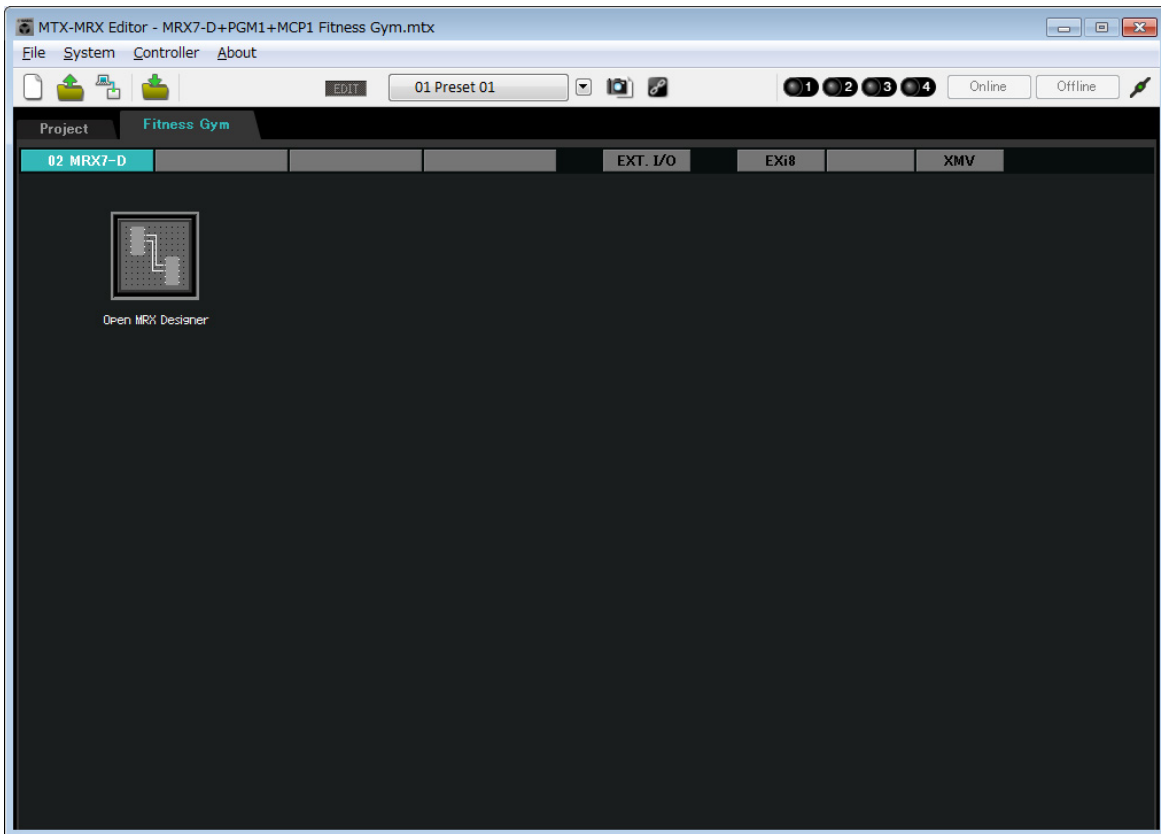

2. Click the [EXT. I/O] button.

The “EXT. I/O” screen appears.

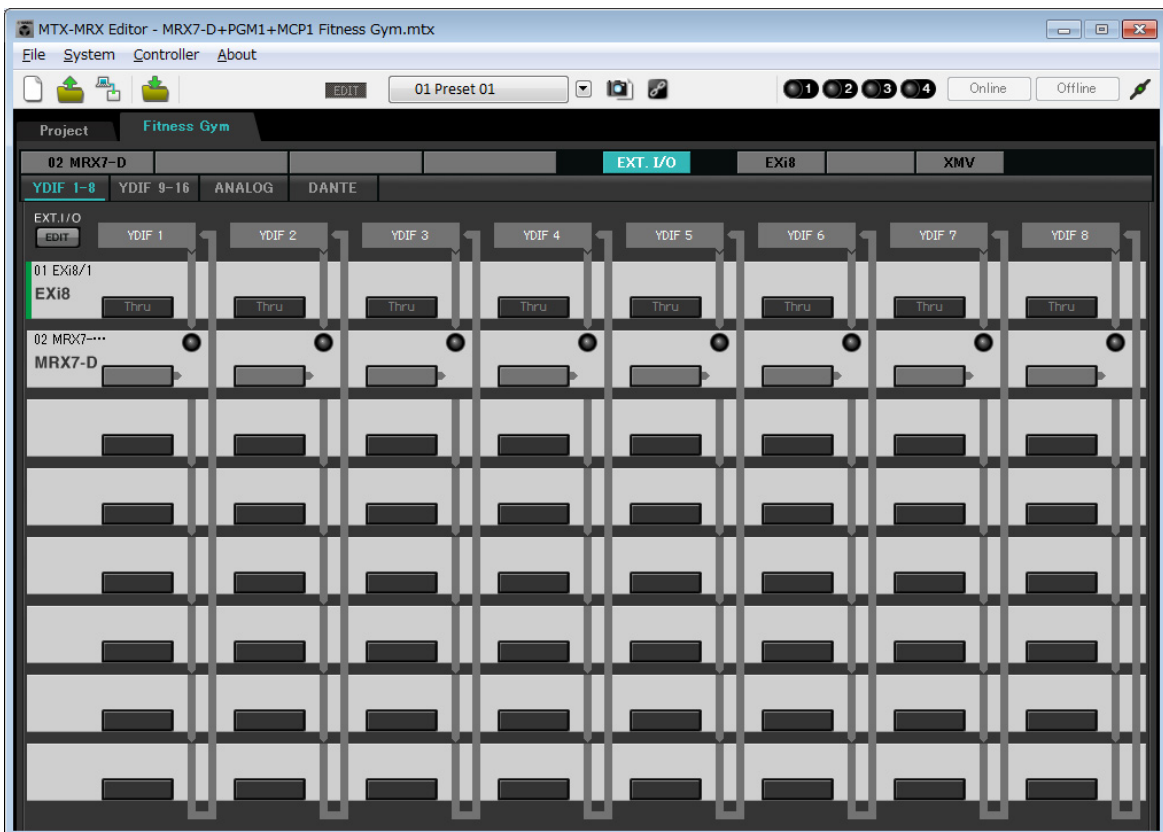

3. Click the [EDIT] button.

Now you can specify the output from YDIF 1–8 of the EXi8.

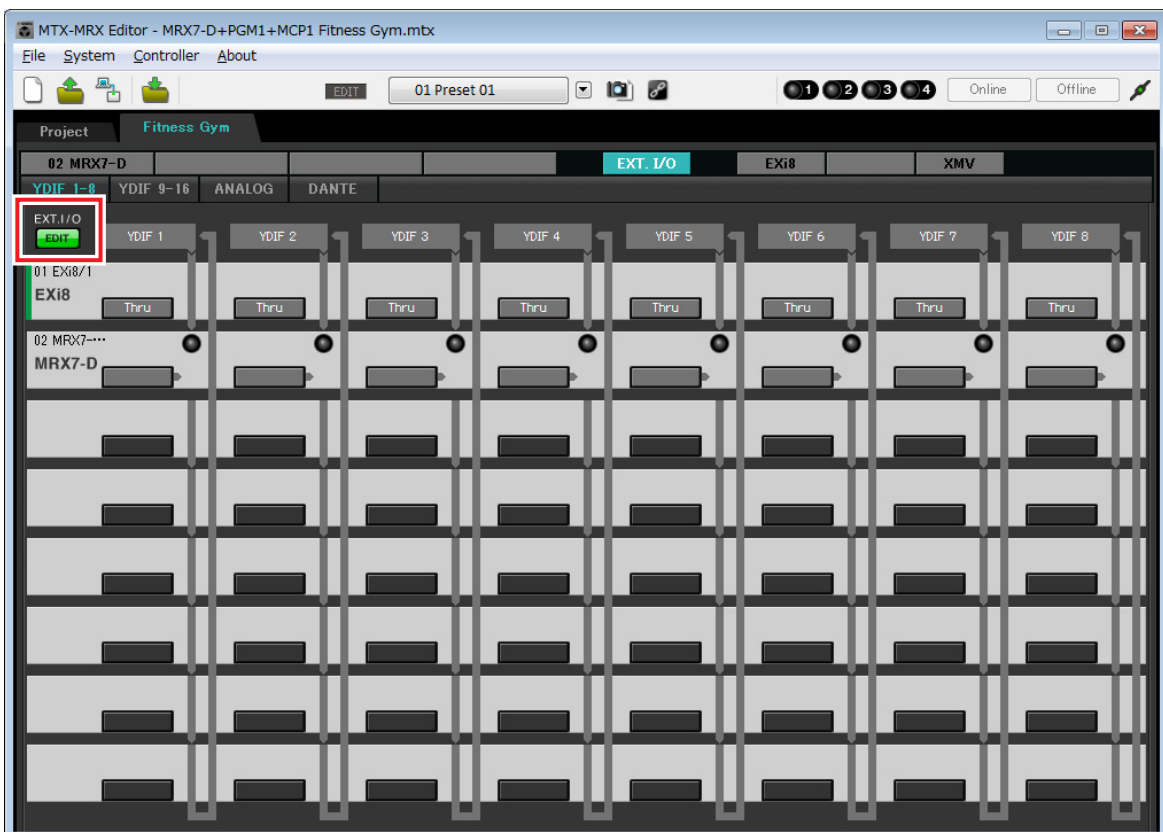

4. Click the EXi8 input routing select button for “YDIF 1.”

The “YDIF In Patch” dialog box appears.

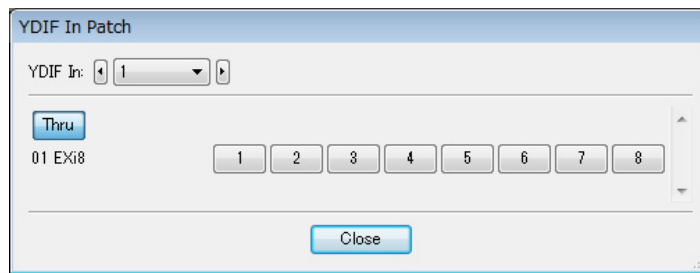

5. Click the [1] button.

The audio signal from the EXi8's [INPUT] jack 1 is output to YDIF 1.

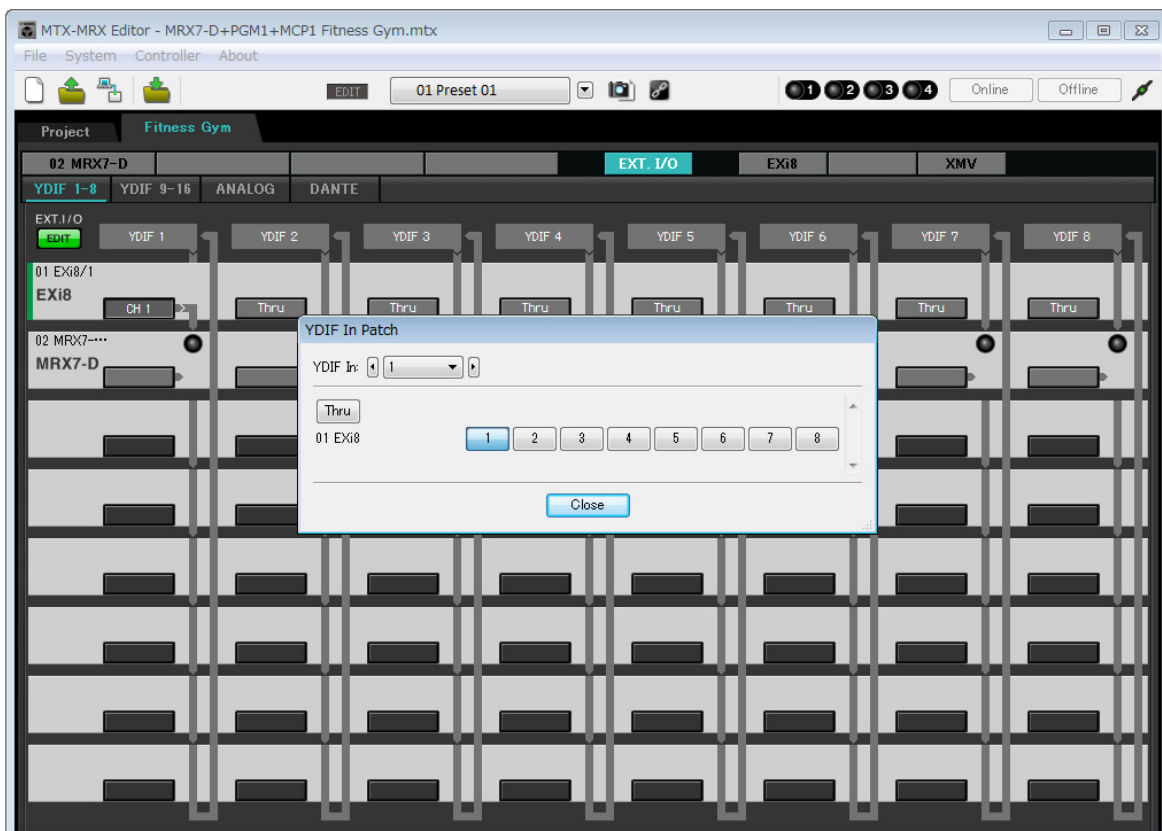

6. In the [YDIF In:] list box, switch the channel to 2.

The object of editing changes to channel 2.

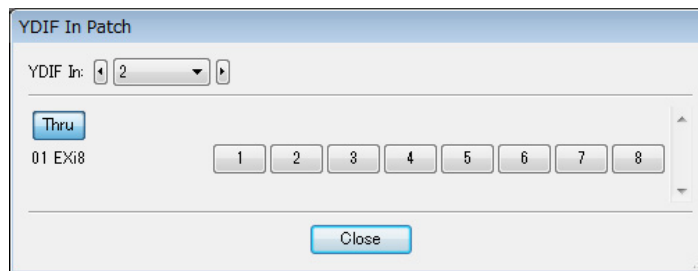

7. Click the [2] button.

The audio signal from the EXi8's [INPUT] jack 2 is output to YDIF 2.

8. As described in steps 6 through 7, assign channel 3 to 3.

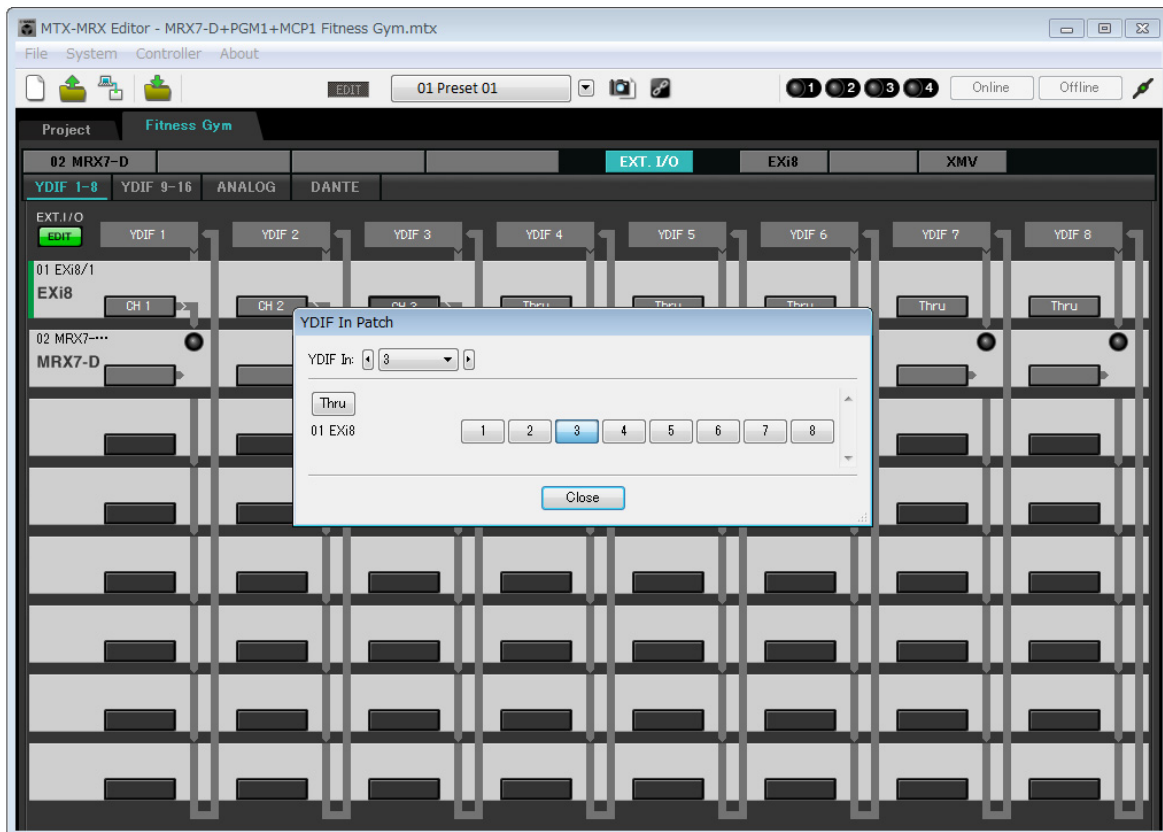

9. Click the [Close] button.

The “YDIF In Patch” dialog box closes.

10. Click the [EDIT] button.

The YDIF input routing select button is disabled.

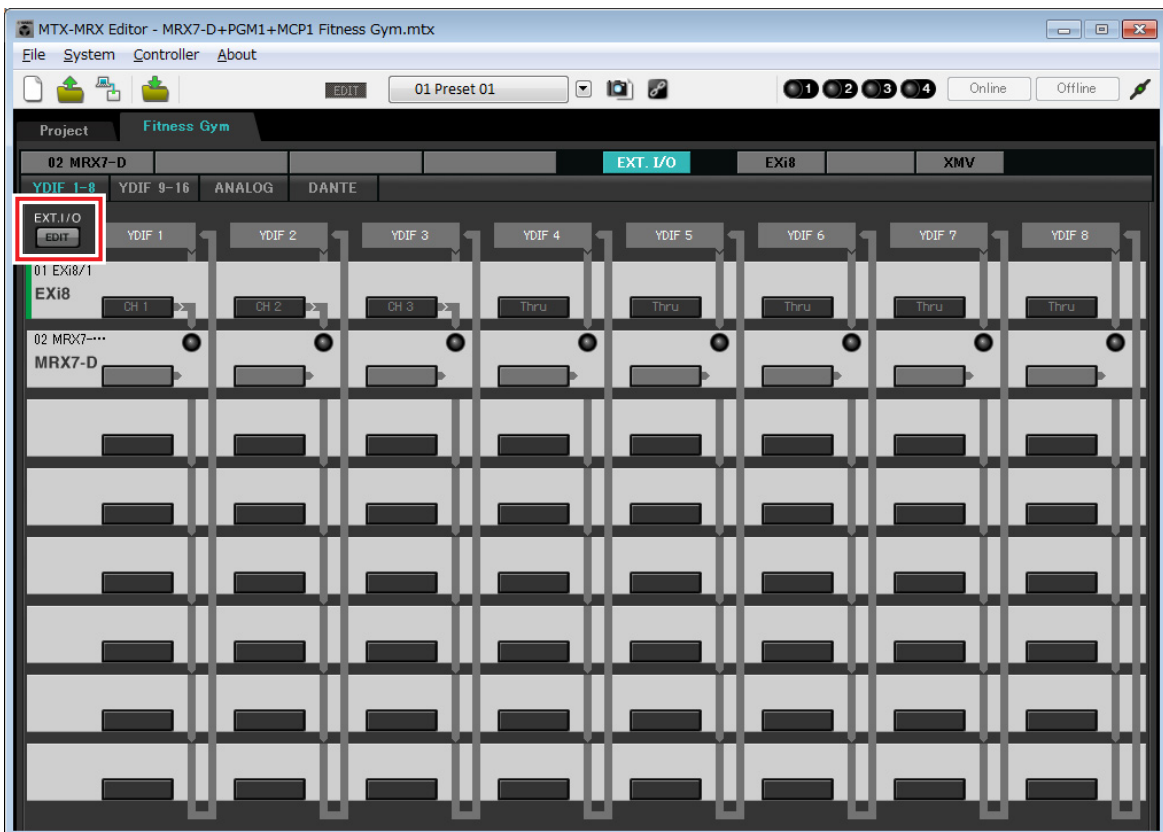

11. Click the [DANTE] button.

The Dante setting screen appears.

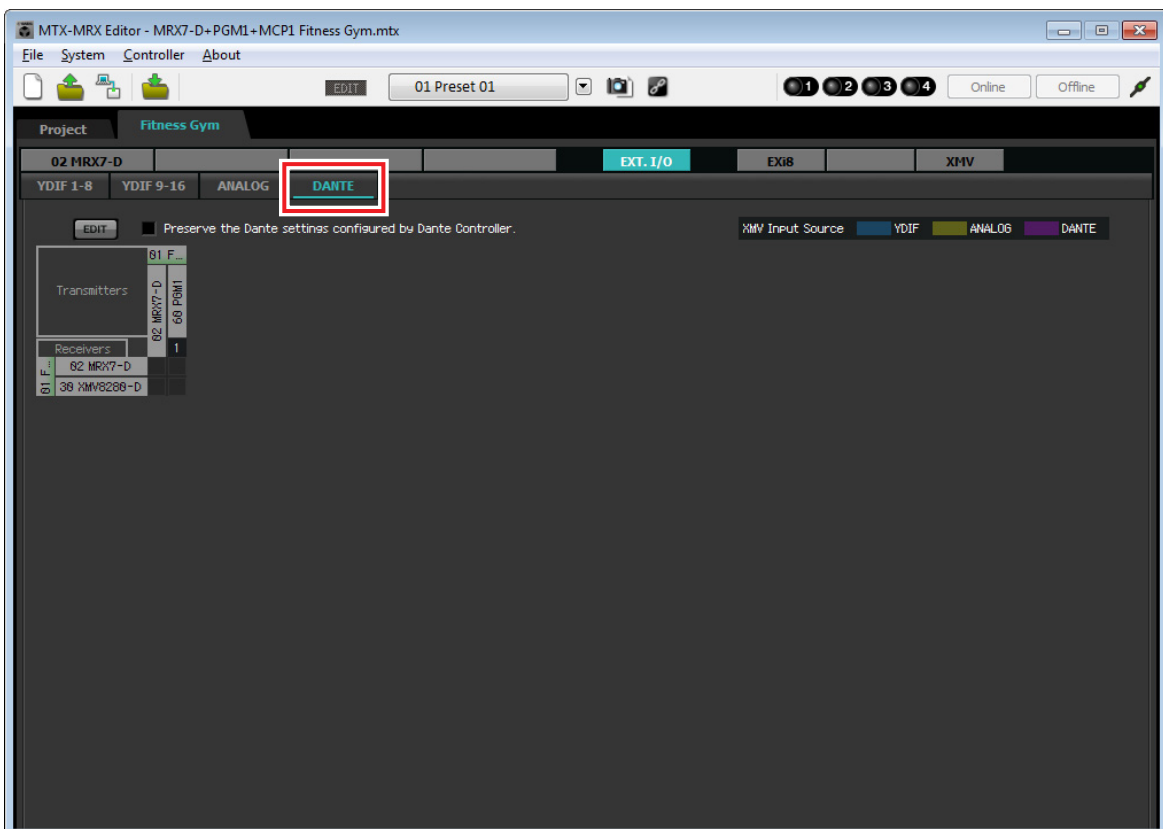

12. Click the [EDIT] button.

Now you can specify Dante input/output settings.

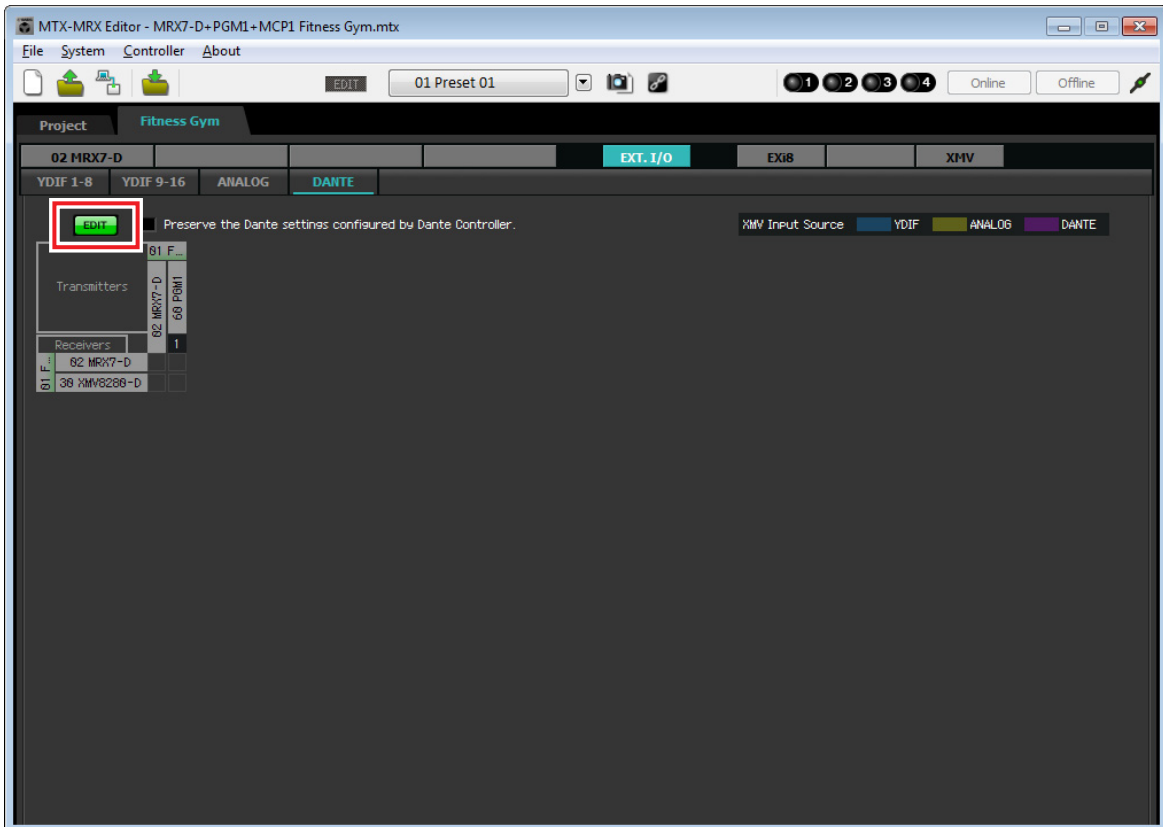

13. Click [1-16] for MRX7-D in [Receivers] and [Transmitters], and click XMV8280-D in [Receivers], so that the indications are expanded.

If they are already expanded, leave them as they are.

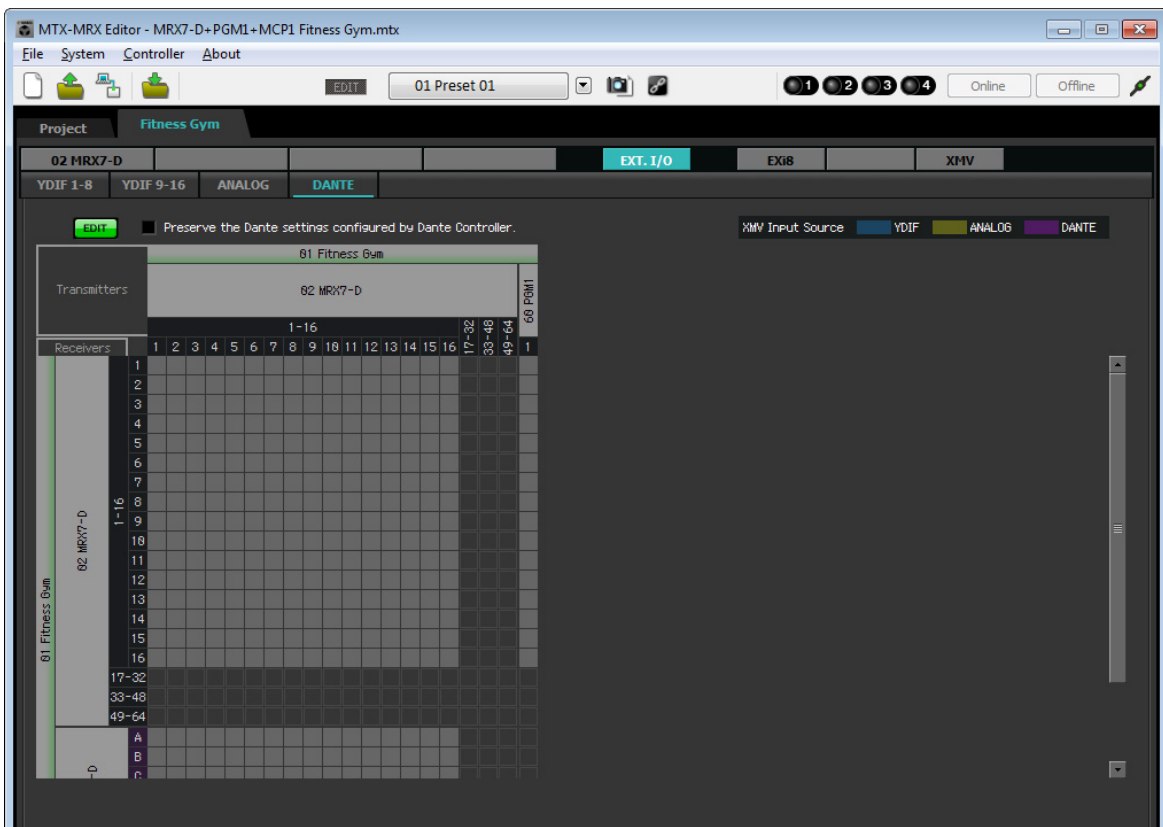

14. Click the location where the “1” of the PGM1 and MRX7-D intersect.

A  appears in the grid.

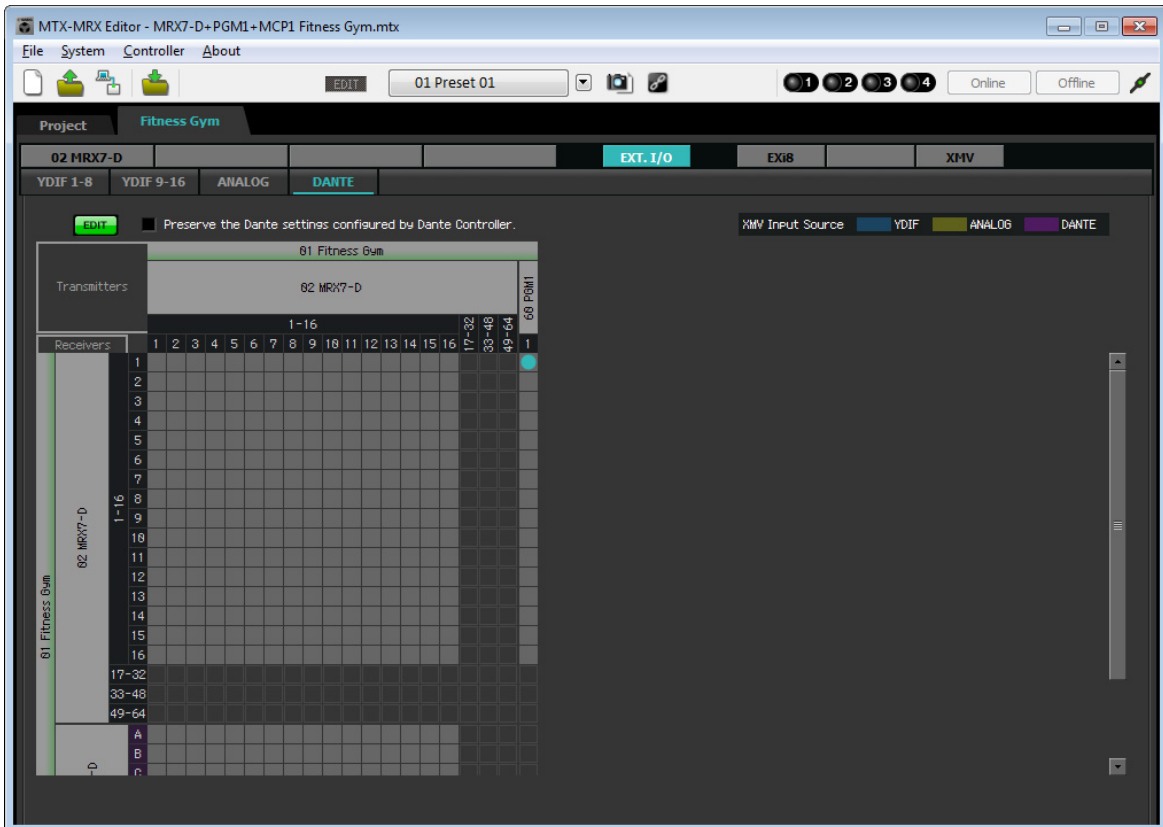

15. Scroll so that the XMV inputs are visible.

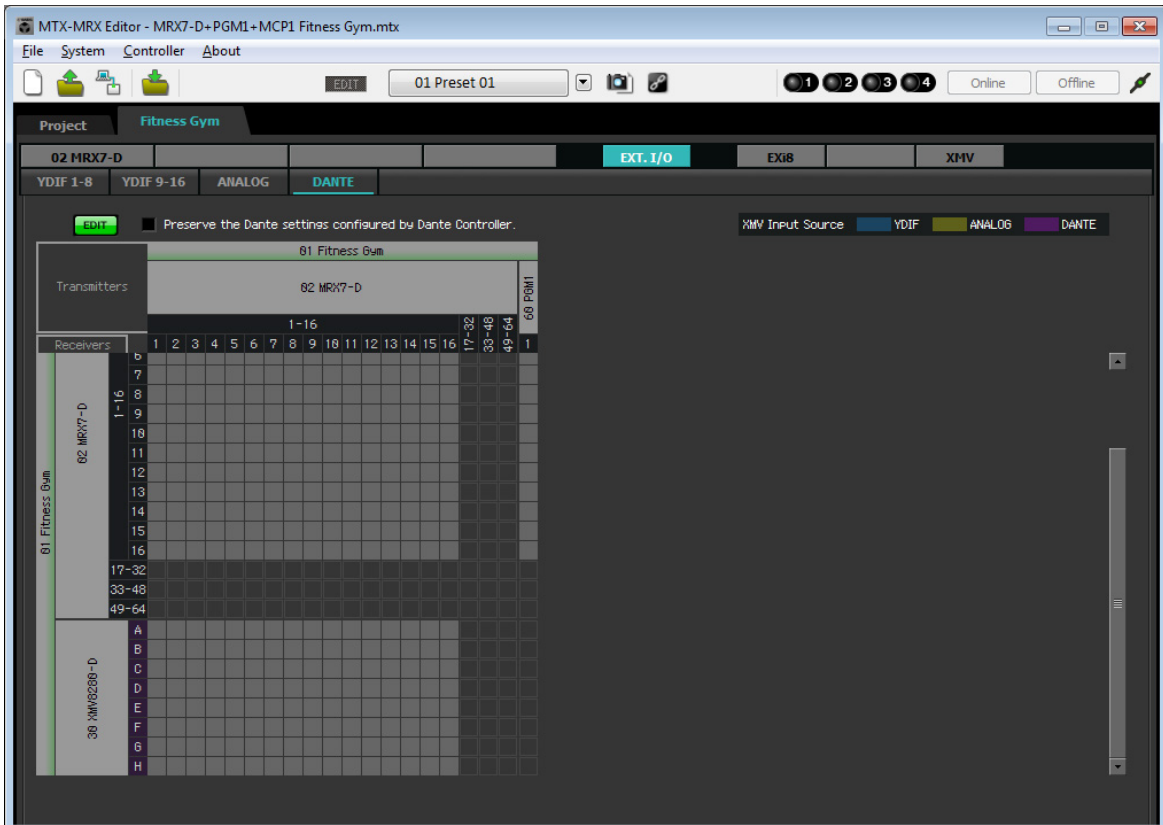

- Click the intersections between the XMV's inputs and the MRX's outputs, so that A intersects with 1, B with 2, C with 3, and so on until H intersects with 8.

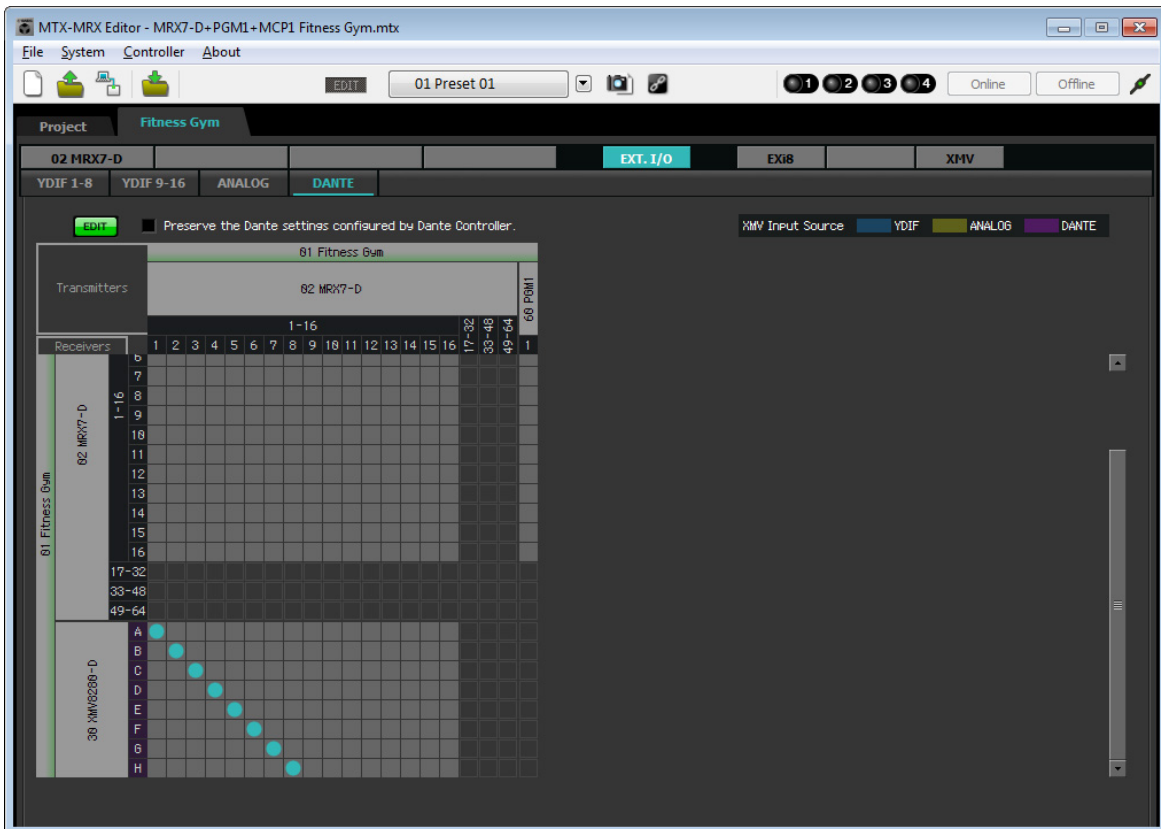

- Click the [EDIT] button to lock the settings.

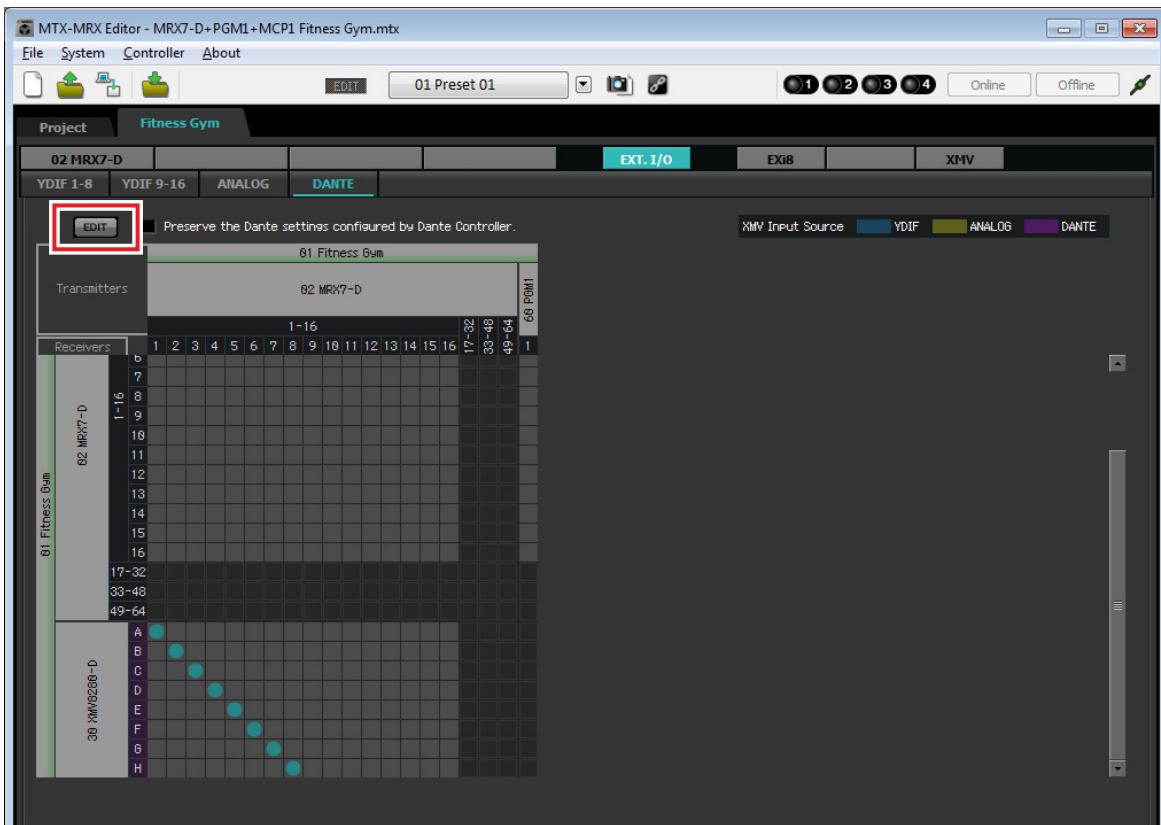

This completes settings in the offline state. Save the settings once again.

Connecting the equipment

After you've rack-mounted the MRX and your other equipment, connect the MRX and the other equipment as shown below. Insert the SD memory card into the MRX at this time.

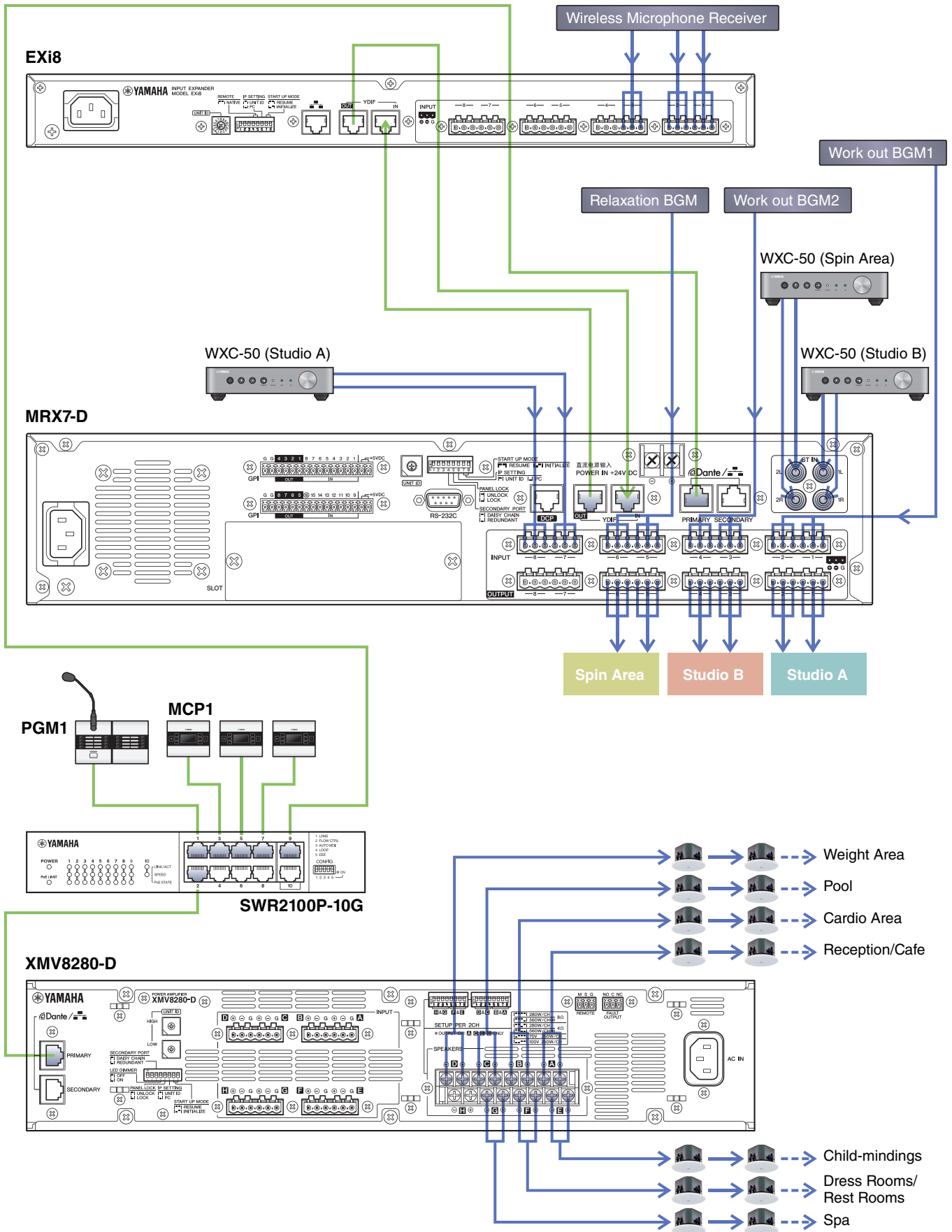

Powering-on the PoE-equipped gigabit network switch

The PGM1 and MCP1 units start.

Specifying the MCP1's UNIT ID

Long-touch the MCP1's home switch to access the utility page.

Choose [Settings] → [Unit ID] and set Studio A to a UNIT ID of 90, Studio B to 91, and Spin Area to 92.

After making the settings, touch the return switch.

For details on UNIT ID settings, refer to "Specifying the UNIT ID" in "MCP1 Installation Manual."

Power-on equipment other than amps and powered speakers

Power-on equipment other than amps and powered speakers.

When powering-off equipment other than amps and powered speakers, start by powering-off the amps and powered speakers.

Power-on amps and powered speakers

Power-on amps and powered speakers.

To prevent unwanted sound from being output, we recommend that you minimize the attenuator settings of all channels on the amp or powered speaker itself before you turn it on.

Specifying the computer's TCP/IP address

To allow the MRX and the computer to communicate, specify the computer's TCP/IP as follows.

1. On MTX-MRX Editor's [System] menu, click [Network Setup].

The "Network Setup" dialog box will appear.

2. Click [Open Network Connection].

"Network Connections" will appear.

3. Right-click the adapter to which the MRX is connected, and choose [Properties].

The "Local Area Connection Properties" dialog box will appear.

4. Choose [Internet Protocol Version 4 (TCP/IPv4)], and then click [Properties].

The "Internet Protocol Version 4 (TCP/IPv4) Properties" dialog box will appear.

5. Click [Use the following IP address (S)].

- In the [IP address] box, enter “192.168.0.253”; in the [Subnet mask] box, enter “255.255.255.0.”

NOTE

The IP address of the MRX7-D is set to “192.168.0.2.”

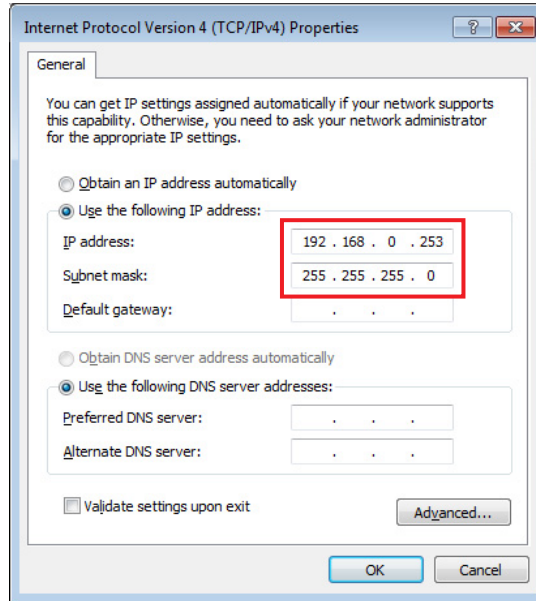

- Click [OK].

NOTE

When you make these settings, the Windows firewall might block MTX-MRX Editor. Select the [Private Network] check box, and click [Allow Access].

Taking MTX-MRX Editor online

In the upper right of MTX-MRX Editor, click the [Online] button. When the unit has successfully come online, indicator 1 at the left will light blue.



When the “Synchronization” dialog box appears, select “To Device,” and click the [OK] button. When the indication of the dialog box has changed, select the check box(es) of the system(s) that you want to bring online, and then click the [Online] button.

The project created in MTX-MRX Editor will be sent to the MRX.

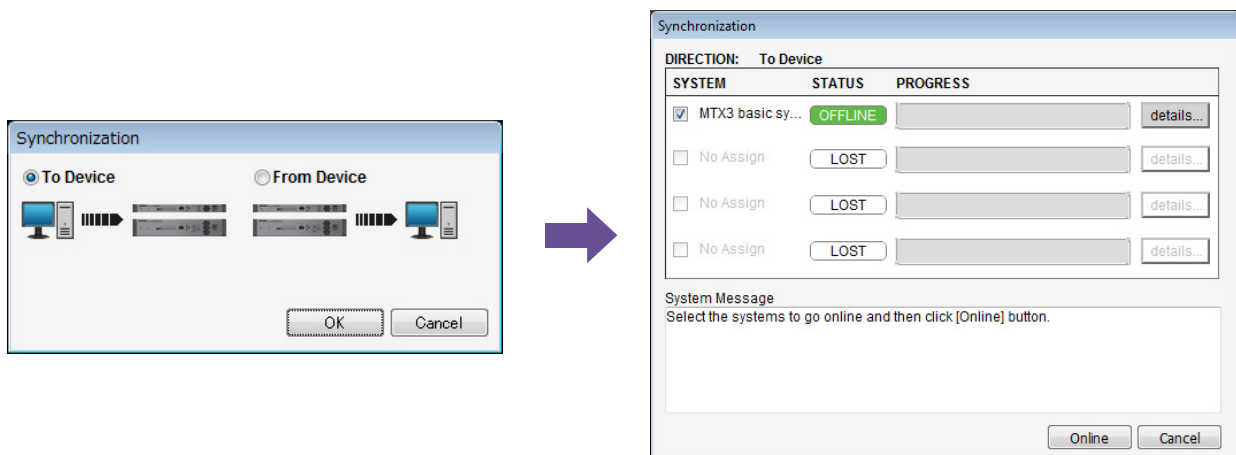

Verifying that the settings were applied

The main items to verify are listed below. For details on each parameter's settings, refer to "MTX-MRX Editor User's Guide" and "MRX Designer User's Guide."

- 1. In "Output Ch." User Defined Block, set "Speaker Processor" to a value appropriate for the speaker.**
- 2. Input audio signals from the analog inputs and stereo inputs into the MRX7-D, and adjust the input levels.**

To check the input levels, you can use the "Fader" component editor and the "Fader" component editor within the "Source Mix" User Defined Block.
- 3. Adjust the EQ using the "PEQ" located inside the "Output Ch." User Defined Block.**

Since the Studio and Spin Area use mics, make adjustments while inputting sound to the mics.
- 4. While inputting sound to the mic, adjust the parameters of the components in the "Input Ch. Strip" User Defined Block.**
- 5. Operate the PGM1 to verify that paging broadcast occurs correctly.**
- 6. Operate the DCP and MCP1 units to verify that they work correctly.**

When you have finished making all settings, save the project and switch MTX-MRX Editor offline.

This completes the settings for example 3.

Q&A

Q: How do you send the rsl file to the iPad?

A: In order to send the rsl file from a computer to the iPad, you can either share the file using iTunes, send the file via e-mail to the iPad, send it via AirDrop, or send it via the File Transfer application. Here we'll explain how to send the file using iTunes.

1. Connect your iPad to the computer.

Start up iTunes. If iTunes does not start up automatically, start the application manually.

2. Click the Device (iPad) button, and then click [Apps].

3. Under “File Sharing”, click “P.V. Touch.”

“File Sharing” is located further down the screen, so you may need to scroll down to see it.

4. Click the “Add...” button, and select the rsl file.

Q: I don't hear the Speech Privacy sound.

A: The environmental sound may not have been sent to the MRX. Follow the steps in example 2 (“[Sending the Speech Privacy environmental sound](#)”) to send the sound to the MRX.

Uninstalling the software (Removing the application)

Use “Settings” to uninstall the software.

Right click [Start]→[Settings]→[Apps], select the item you want to uninstall, and then click [Uninstall].

A dialog box will appear; follow the instructions in the screen to uninstall the software.

If the “User Account Control” dialog box appears, click [Continue] or [Yes].