

# Dimensions / 寸法図 (1/6)

UB-DZR15H

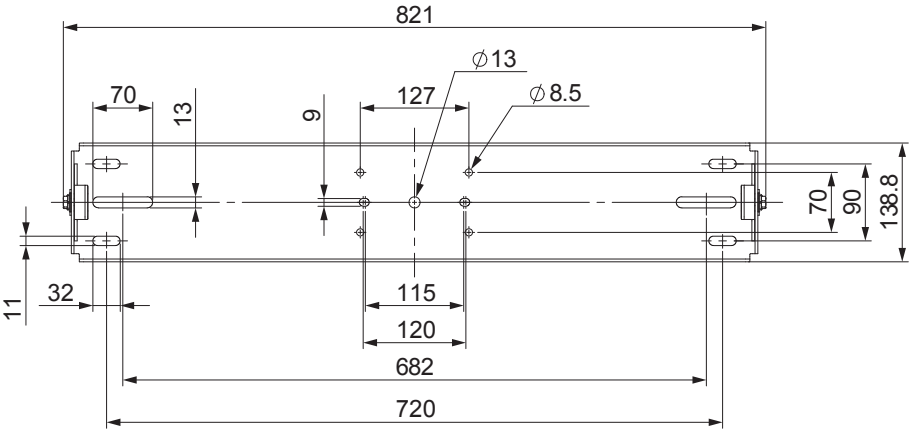
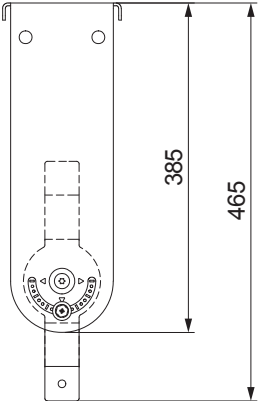

# Dimensions / 寸法図 (2/6)

UB-DZR15V

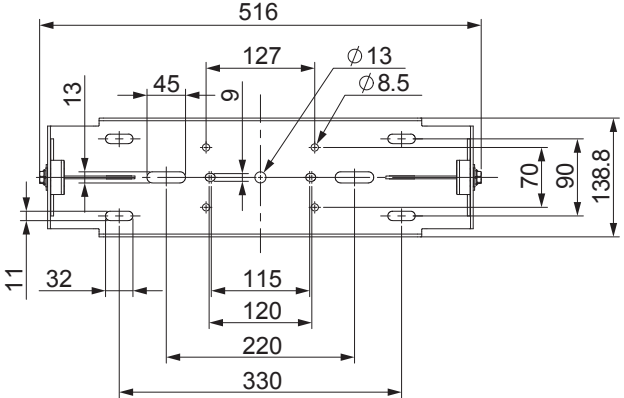
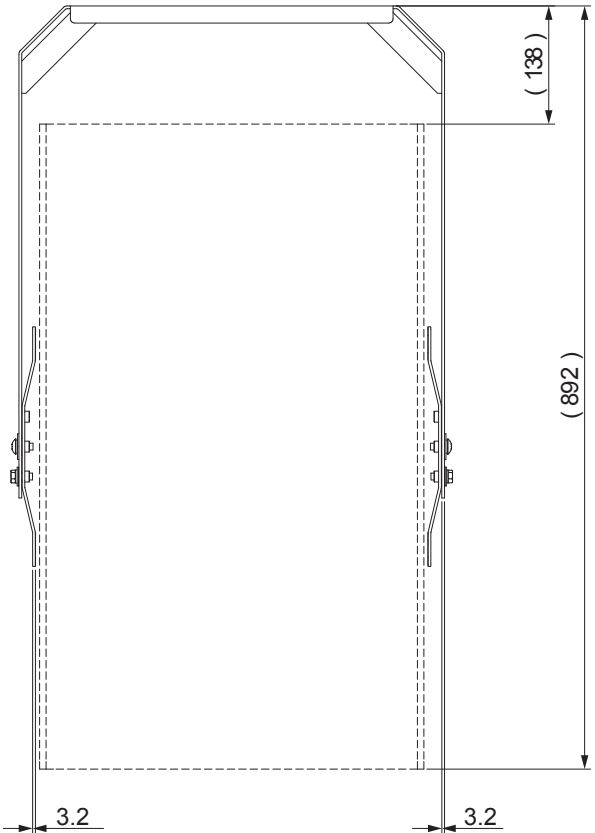
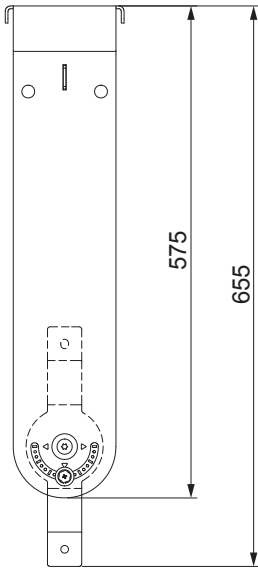

Unit: mm

# Dimensions / 寸法図 (3/6)

UB-DZR12H

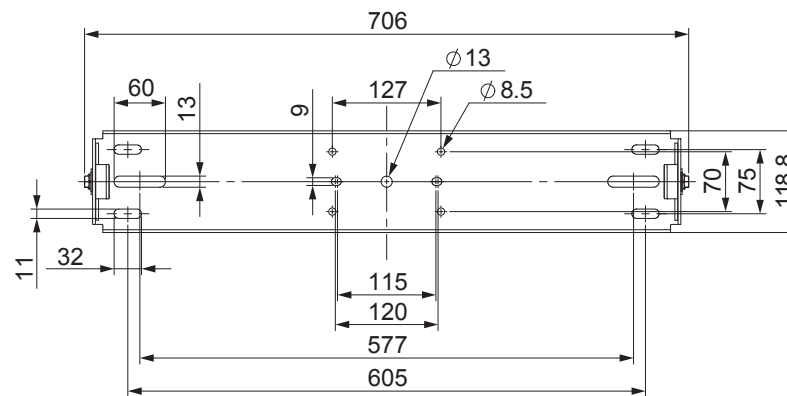
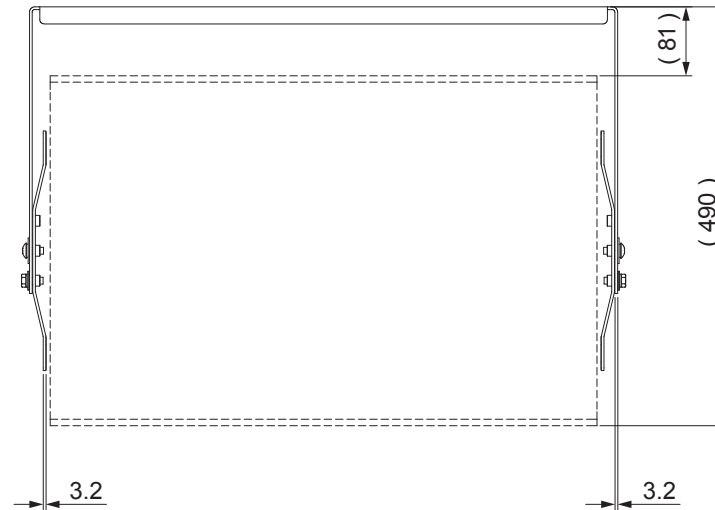
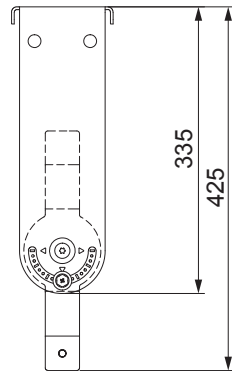

Unit: mm

# Dimensions / 寸法図 (4/6)

UB-DZR12V

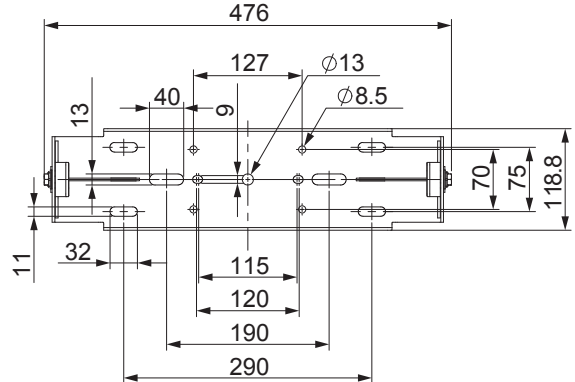
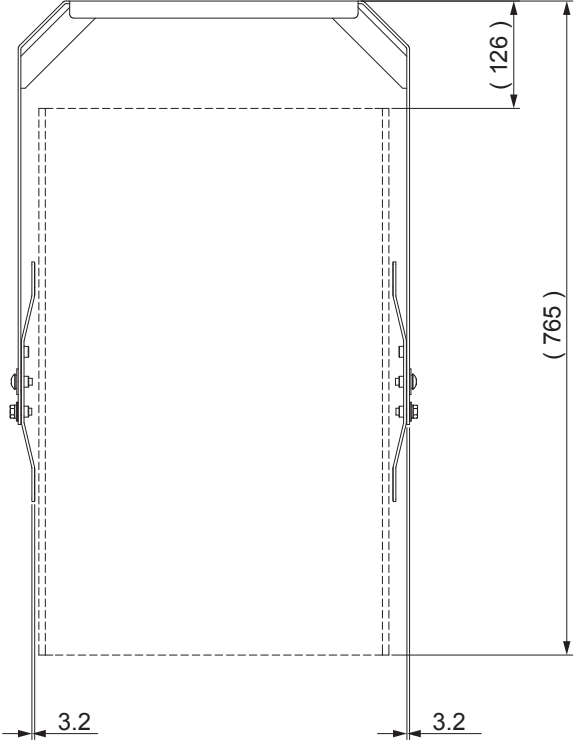
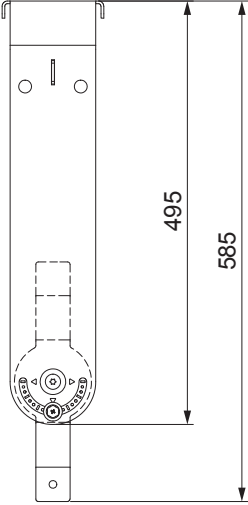

# Dimensions / 寸法図 (5/6)

UB-DZR10H

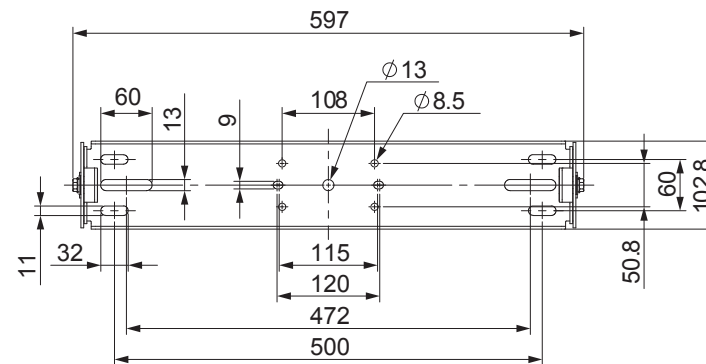
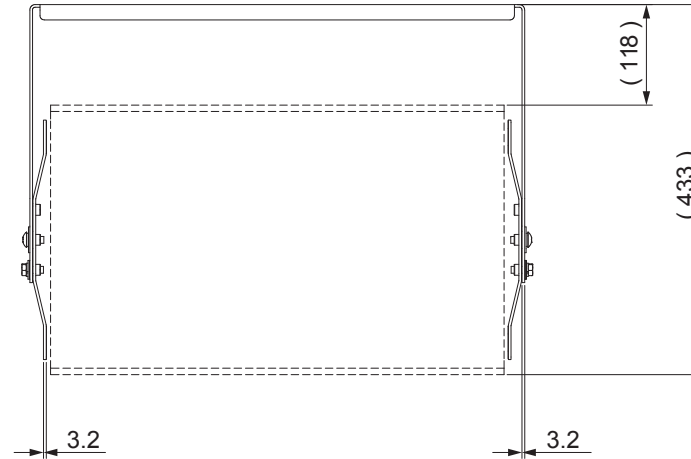
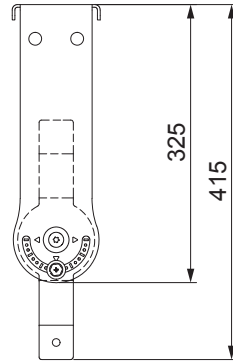

# Dimensions / 寸法図 (6/6)

UB-DZR10V

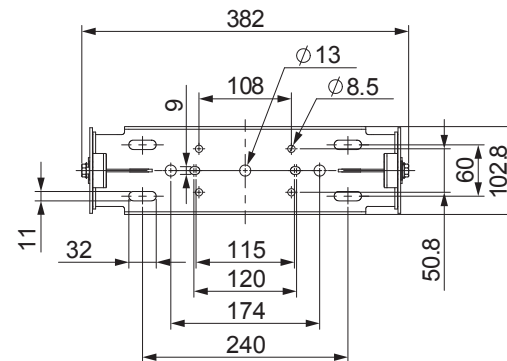
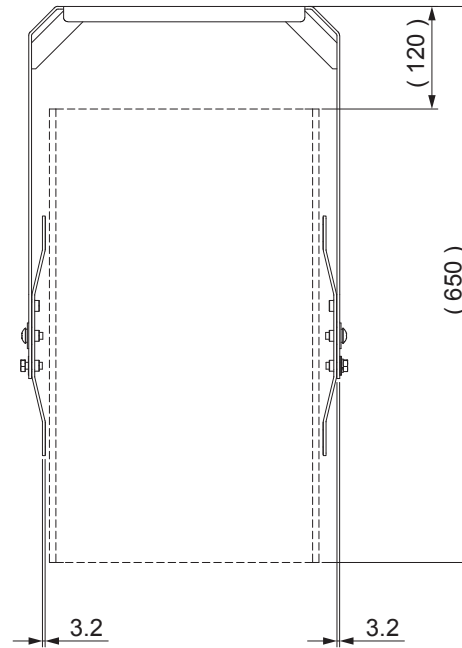
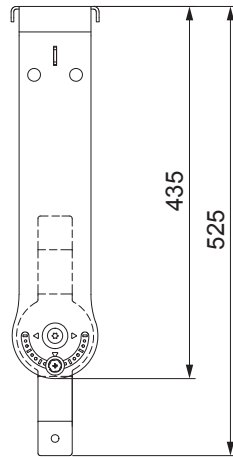

Unit: mm