



DIGITAL WORKSTATION

# Tyros3

Owner's Manual

# SPECIAL MESSAGE SECTION

**PRODUCT SAFETY MARKINGS:** Yamaha electronic products may have either labels similar to the graphics shown below or molded/stamped facsimiles of these graphics on the enclosure. The explanation of these graphics appears on this page. Please observe all cautions indicated on this page and those indicated in the safety instruction section.

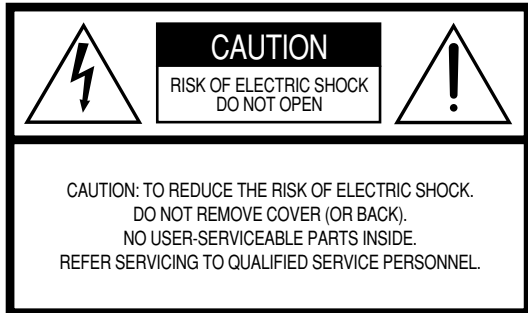

The exclamation point within the equilateral triangle is intended to alert the user to the presence of important operating and maintenance (servicing) instructions in the literature accompanying the product.

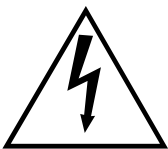

The lightning flash with arrowhead symbol, within the equilateral triangle, is intended to alert the user to the presence of uninsulated “dangerous voltage” within the product’s enclosure that may be of sufficient magnitude to constitute a risk of electrical shock.

**IMPORTANT NOTICE:** All Yamaha electronic products are tested and approved by an independent safety testing laboratory in order that you may be sure that when it is properly installed and used in its normal and customary manner, all foreseeable risks have been eliminated. **DO NOT** modify this unit or commission others to do so unless specifically authorized by Yamaha. Product performance and/or safety standards may be diminished. Claims filed under the expressed warranty may be denied if the unit is/has been modified. Implied warranties may also be affected.

**SPECIFICATIONS SUBJECT TO CHANGE:** The information contained in this manual is believed to be correct at the time of printing. However, Yamaha reserves the right to change or modify any of the specifications without notice or obligation to update existing units.

**ENVIRONMENTAL ISSUES:** Yamaha strives to produce products that are both user safe and environmentally friendly. We sincerely believe that our products and the production methods used to produce them, meet these goals. In keeping with both the letter and the spirit of the law, we want you to be aware of the following:

**Battery Notice:** This product **MAY** contain a small non-rechargeable battery which (if applicable) is soldered in place. The average life span of this type of battery is approximately five years. When replacement becomes necessary, contact a qualified service representative to perform the replacement.

**Warning:** Do not attempt to recharge, disassemble, or incinerate this type of battery. Keep all batteries away from children. Dispose of used batteries promptly and as regulated by applicable laws. **Note:** In some areas, the servicer is required by law to return the defective parts. However, you do have the option of having the servicer dispose of these parts for you.

**Disposal Notice:** Should this product become damaged beyond repair, or for some reason its useful life is considered to be at an end, please observe all local, state, and federal regulations that relate to the disposal of products that contain lead, batteries, plastics, etc.

**NOTICE:** Service charges incurred due to lack of knowledge relating to how a function or effect works (when the unit is operating as designed) are not covered by the manufacturer’s warranty, and are therefore the owners responsibility. Please study this manual carefully and consult your dealer before requesting service.

**NAME PLATE LOCATION:** The graphic below indicates the location of the name plate. The model number, serial number, power requirements, etc., are located on this plate. You should record the model number, serial number, and the date of purchase in the spaces provided below and retain this manual as a permanent record of your purchase.

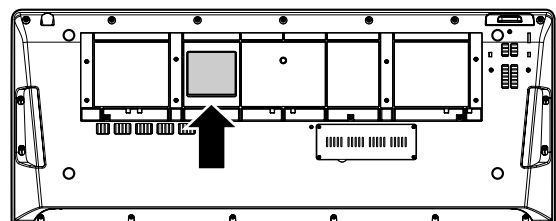

**Model** \_\_\_\_\_

**Serial No.** \_\_\_\_\_

**Purchase Date** \_\_\_\_\_

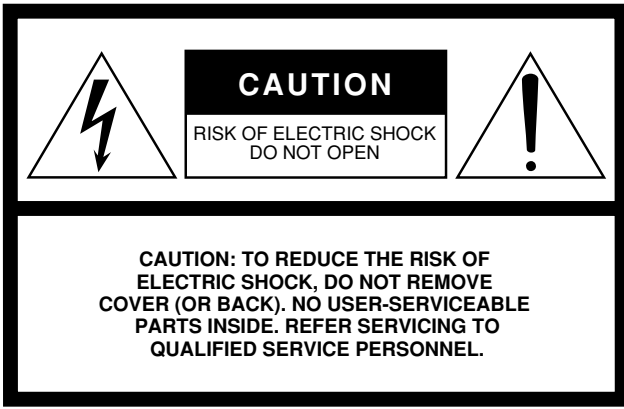

The above warning is located on the rear of the unit.

## Explanation of Graphical Symbols

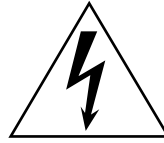

The lightning flash with arrowhead symbol within an equilateral triangle is intended to alert the user to the presence of uninsulated “dangerous voltage” within the product’s enclosure that may be of sufficient magnitude to constitute a risk of electric shock to persons.



The exclamation point within an equilateral triangle is intended to alert the user to the presence of important operating and maintenance (servicing) instructions in the literature accompanying the product.

# IMPORTANT SAFETY INSTRUCTIONS

- 1 Read these instructions.
- 2 Keep these instructions.
- 3 Heed all warnings.
- 4 Follow all instructions.
- 5 Do not use this apparatus near water.
- 6 Clean only with dry cloth.
- 7 Do not block any ventilation openings. Install in accordance with the manufacturer’s instructions.
- 8 Do not install near any heat sources such as radiators, heat registers, stoves, or other apparatus (including amplifiers) that produce heat.
- 9 Do not defeat the safety purpose of the polarized or grounding-type plug. A polarized plug has two blades with one wider than the other. A grounding type plug has two blades and a third grounding prong. The wide blade or the third prong are provided for your safety. If the provided plug does not fit into your outlet, consult an electrician for replacement of the obsolete outlet.
- 10 Protect the power cord from being walked on or pinched particularly at plugs, convenience receptacles, and the point where they exit from the apparatus.
- 11 Only use attachments/accessories specified by the manufacturer.
- 12 Use only with the cart, stand, tripod, bracket, or table specified by the manufacturer, or sold with the apparatus. When a cart is used, use caution when moving the cart/apparatus combination to avoid injury from tip-over.
- 13 Unplug this apparatus during lightning storms or when unused for long periods of time.
- 14 Refer all servicing to qualified service personnel. Servicing is required when the apparatus has been damaged in any way, such as power-supply cord or plug is damaged, liquid has been spilled or objects have fallen into the apparatus, the apparatus has been exposed to rain or moisture, does not operate normally, or has been dropped.



### WARNING

TO REDUCE THE RISK OF FIRE OR ELECTRIC SHOCK, DO NOT EXPOSE THIS APPARATUS TO RAIN OR MOISTURE.

(UL60065\_03)

# PRECAUTIONS

## PLEASE READ CAREFULLY BEFORE PROCEEDING

\* Please keep this manual in a safe place for future reference.



### WARNING

Always follow the basic precautions listed below to avoid the possibility of serious injury or even death from electrical shock, short-circuiting, damages, fire or other hazards. These precautions include, but are not limited to, the following:

#### Power supply/Power cord

- Only use the voltage specified as correct for the instrument. The required voltage is printed on the name plate of the instrument.
- Check the electric plug periodically and remove any dirt or dust which may have accumulated on it.
- Use only the supplied power cord/plug.
- Do not place the power cord near heat sources such as heaters or radiators, and do not excessively bend or otherwise damage the cord, place heavy objects on it, or place it in a position where anyone could walk on, trip over, or roll anything over it.
- Be sure to connect to an appropriate outlet with a protective grounding connection. Improper grounding can result in electrical shock.

#### Do not open

- This instrument contains no user-serviceable parts. Do not attempt to disassemble or modify the internal components in any way.

#### Water warning

- Do not expose the instrument to rain, use it near water or in damp or wet conditions, or place containers on it containing liquids which might spill into any openings. If any liquid such as water seeps into the instrument, turn off the power immediately and unplug the power cord from the AC outlet. Then have the instrument inspected by qualified Yamaha service personnel.
- Never insert or remove an electric plug with wet hands.

#### Fire warning

- Do not put burning items, such as candles, on the unit.  
A burning item may fall over and cause a fire.

#### If you notice any abnormality

- If the power cord or plug becomes frayed or damaged, or if there is a sudden loss of sound during use of the instrument, or if any unusual smells or smoke should appear to be caused by it, immediately turn off the power switch, disconnect the electric plug from the outlet, and have the instrument inspected by qualified Yamaha service personnel.



### CAUTION

Always follow the basic precautions listed below to avoid the possibility of physical injury to you or others, or damage to the instrument or other property. These precautions include, but are not limited to, the following:

#### Power supply/Power cord

- Always connect the three-pin attachment plug to a properly grounded power source. (For more information about the main power supply, see page 16.)
- When removing the electric plug from the instrument or an outlet, always hold the plug itself and not the cord. Pulling by the cord can damage it.
- Remove the electric plug from the outlet when the instrument is not to be used for extended periods of time, or during electrical storms.
- Do not connect the instrument to an electrical outlet using a multiple-connector. Doing so can result in lower sound quality, or possibly cause overheating in the outlet.

#### Location

- Do not expose the instrument to excessive dust or vibrations, or extreme cold or heat (such as in direct sunlight, near a heater, or in a car during the day) to prevent the possibility of panel discoloration or damage to the internal components.

- Do not use the instrument in the vicinity of a TV, radio, stereo equipment, mobile phone, or other electric devices. Otherwise, the instrument, TV, or radio may generate noise.
- Do not place the instrument in an unstable position where it might accidentally fall over.
- Before moving the instrument, remove all connected cables.
- When setting up the product, make sure that the AC outlet you are using is easily accessible. If some trouble or malfunction occurs, immediately turn off the power switch and disconnect the plug from the outlet. Even when the power switch is turned off, electricity is still flowing to the product at the minimum level. When you are not using the product for a long time, make sure to unplug the power cord from the wall AC outlet.
- Use only the stand specified for the instrument. When attaching the stand or rack, use the provided screws only. Failure to do so could cause damage to the internal components or result in the instrument falling over.
- Do not place objects in front of the instrument's air vent, since this may prevent adequate ventilation of the internal components, and possibly result in the instrument overheating.

## Connections

- Before connecting the instrument to other electronic components, turn off the power for all components. Before turning the power on or off for all components, set all volume levels to minimum. Also, be sure to set the volumes of all components at their minimum levels and gradually raise the volume controls while playing the instrument to set the desired listening level.

## Maintenance

- When cleaning the instrument, use a soft, dry cloth. Do not use paint thinners, solvents, cleaning fluids, or chemical-impregnated wiping cloths.

## Handling caution

- Do not insert a finger or hand in any gaps on the instrument.
- Never insert or drop paper, metallic, or other objects into the gaps on the panel or keyboard. If this happens, turn off the power immediately and unplug the power cord from the AC outlet. Then have the instrument inspected by qualified Yamaha service personnel.
- Do not place vinyl, plastic or rubber objects on the instrument, since this might discolor the panel or keyboard.
- Do not rest your weight on, or place heavy objects on the instrument, and do not use excessive force on the buttons, switches or connectors.
- Do not use the instrument/device or headphones for a long period of time at a high or uncomfortable volume level, since this can cause permanent hearing loss. If you experience any hearing loss or ringing in the ears, consult a physician.
- Do not subject the instrument to strong physical shock. Excessive physical shock can damage the internal hard disk.
- Always turn the power off when moving the instrument from one location to another. Data on the internal hard disk can be lost or corrupted if the instrument is moved while the power is on.

## Saving data

### Saving and backing up your data

- The data of the types listed below are lost when you turn off the power to the instrument. Save the data to the User drive or appropriate external media (page 30).
  - Created/Edited Voices (page 47)
  - Created/Edited Styles (page 56)
  - Memorized One Touch Settings (page 56)
  - Recorded/Edited Songs (page 63)
  - Created Multi Pads (page 65)
  - Edited MIDI Settings (page 98)

Data in the User drive (page 26) may be lost due to malfunction or incorrect operation. Save important data to an external media.

Data in the internal hard disk drive may be lost due to malfunction or incorrect operation. We recommend that you backup any necessary data to computer by using the USB Storage Mode (pages 97, 104).

### Backing up the USB storage device/external media

- To protect against data loss through media damage, we recommend that you save your important data onto two USB storage devices/external media.

When you change settings in a display page and then exit from that page, System Setup data (listed in the Parameter Chart of the Data List downloadable from the web) is automatically stored. However, this edited data is lost if you turn off the power without properly exiting from the relevant display. Refer to page 8 how to obtain the Data List.

Yamaha cannot be held responsible for damage caused by improper use or modifications to the instrument, or data that is lost or destroyed.

Always turn the power off when the instrument is not in use.

## Congratulations!

You are the proud owner of an extraordinary electronic keyboard. The Yamaha Tyros3 combines the most advanced tone generation technology with state-of-the-art digital electronics and features to give you stunning sound quality with maximum musical versatility.

In order to make the most of your Tyros3's features and vast performance potential, we urge you to read the manual thoroughly while trying out the various features described. Keep the manual in a safe place for later reference.

# Included Accessories

---

- AC power cord
- Music rest and brackets
- CD-ROM
- Owner's Manual
- Installation Guide
- User Registration Card

### ● About the included CD-ROM

The accompanying CD-ROM features special software for use with the Tyros3. Included is a Voice Editor, which gives you comprehensive and intuitive editing tools for the Tyros3. For details, see the separate Installation Guide or the online manual included with the software.

 **CAUTION**

Never attempt to play back the CD-ROM on an audio CD player. Doing so may result in damage to your hearing as well as to your CD player/audio speaker.

# Main Features

## ● Realistic and richly textured Voices

The new SA2 Voices created with Yamaha's AEM (Articulation Element Modeling) technology let you play those Voices more naturally and with greater expressiveness—particularly the wind instrument sounds (page 40). What's more, the Tyros3 has enhanced the already high-quality piano Voices and other important Voices for playing accompaniment (drum, guitar, etc.), and it newly features Synth Voices inherited from our flagship MOTIF series synthesizer.

## ● Intuitive, quick-access sliders

Eight sliders have been provided just below the LCD display let you conveniently and quickly adjust all parameters shown in the display. The additional ASSIGN slider allows you to assign a desired function (volume, reverb, etc.) and control it in realtime during your performance (page 21).

These nine sliders function as footage levers when the Organ Flutes display is shown (page 46).

## ● Dynamic, contemporary Auto Accompaniment Styles

The Tyros3 contains a huge amount of exceptionally high-quality Styles including the new MegaVoices. They feature a newly developed note transposition system for guitar tracks and additional two DSP effect blocks exclusively for the Styles.

## ● Two-track Hard Disk Recorder

The Hard Disk Recorder lets you record your performances to two audio tracks—Main and Sub. A Bounce recording feature lets you record even more tracks, allowing you to easily record multiple parts in layers (page 74).

## ● Convenient Multi Pad Sync function / Registrations and OTS Information

You can embellish your performance as you play with several preset phrases by using the Multi Pads. These can even be synchronized with Style/Song playback (page 65).

The information displays for Registration Memory and One Touch Setting allow you to confirm the registered panel setups easily (pages 53, 70).

## ● Voice Expandability

Download additional Voices from the website and load them to the Tyros3—and increase your selection of available Voices (page 39).

## ● Easy connection with peripheral devices

The built-in LAN terminal lets you easily connect your Tyros3 directly to the Internet (page 82). The USB terminals compatible with USB 2.0 HighSpeed enable high-speed communication with USB storage devices and computers (pages 94, 96).

The Tyros3 is compatible with the following formats.



“GM (General MIDI)” is one of the most common Voice allocation formats. “GM System Level 2” is a standard specification that enhances the original “GM” and improves Song data compatibility. It provides for increased polyphony, greater Voice selection, expanded Voice parameters, and integrated effect processing.



XG is a major enhancement of the GM System Level 1 format, and was developed by Yamaha specifically to provide more Voices and variations, as well as greater expressive control over Voices and effects, and to ensure compatibility of data well into the future.



GS was developed by the Roland Corporation. In the same way as Yamaha XG, GS is a major enhancement of the GM specifically to provide more Voices and Drum kits and their variations, as well as greater expressive control over Voices and effects.



The Yamaha XF format enhances the SMF (Standard MIDI File) standard with greater functionality and open-ended expandability for the future. The Tyros3 is capable of displaying lyrics when an XF file containing lyric data is played.



“SFF (Style File Format)” is an original Style file format by Yamaha which uses a unique conversion system to provide high-quality automatic accompaniment based on a wide range of chord types. “SFF GE (Guitar Edition)” is an enhanced format of SFF, which features improved note transposition for guitar tracks.



VH (Vocal Harmony) employs the digital signal processing technology to automatically add appropriate vocal harmonies to a lead vocal line sung by the user.



“AEM” is the trademark of Yamaha's leading-edge tone generation technology. For information on AEM, refer to page 40.

# About the Manuals

This instrument has the following documents and instructional materials.

## Included Documents



### **Owner's Manual (this book)**

Provides overall explanations of the Tyros3 basic functions. See page 9 for information how to use the Owner's Manual.



### **Installation Guide**

Explains how to install the Voice Editor software included in the CD-ROM.

## Online Materials (Downloadable from the web)

The following instructional materials are available for downloading from the Yamaha Manual Library.

### **Yamaha Manual Library**

<http://www.yamaha.co.jp/manual/>



### **Reference Manual (only in English, French and German)**

Explains advanced features of the Tyros3, not explained in the Owner's Manual. For example, you can learn how to create original Voices, Styles, Songs or Multi Pads, or find detailed explanations of specific parameters.



### **Data List**

Contains various important preset content lists such as Voices, Styles, Effects, as well as MIDI-related information.



### **MIDI Basics (only in English, French and German)**

If you want to know more about MIDI and how to use it, refer to this introductory book.

### **Copyright Notice**

The following is the title, credits, and copyright notices for the song pre-installed in this instrument.

#### **Beauty And The Beast**

from Walt Disney's BEAUTY AND THE BEAST

Lyrics by Howard Ashman

Music by Alan Menken

© 1991 Walt Disney Music Company and Wonderland Music Company, Inc.

All Rights Reserved Used by Permission

#### **Can't Help Falling In Love**

from the Paramount Picture BLUE HAWAII

Words and Music by George David Weiss, Hugo Peretti and Luigi Creatore

Copyright © 1961 by Gladys Music, Inc.

Copyright Renewed and Assigned to Gladys Music

All Rights Administered by Cherry Lane Music Publishing Company, Inc. and Chrysalis Music

International Copyright Secured All Rights Reserved



# How to use this Owner's Manual

## ● Starting Up.....page 16

Before going on to any other part of the manual, we strongly suggest you read this section first. It shows you how to get started playing and using your new Tyros3.

## ● Basic Operations.....page 20

Here, we'll show you the basic operations using the LCD display and the basic structure in handling and organizing the data of the Tyros3 in files.

## ● Chapters 1–11 .....pages 36–99

These chapters cover basic instructions on using each function of the Tyros3. At the end of each chapter is an "Advanced Features" section, which briefly introduces more sophisticated features and functions not described in this Owner's Manual. For detailed explanations on these, refer to the Reference Manual (page 8). The chapter structure of the Reference Manual is the same as this Owner's Manual.

## ● Troubleshooting.....page 106

If the Tyros3 does not function as expected or you have some problem with the sound or operation, refer to this section before calling Yamaha dealer or service center. Most common problems and their solutions are covered here in a very simple and easy-to-understand way. If your particular problem cannot be solved by following the guidelines in this section, we recommend referring also to the Reference Manual (page 8).

## ● Panel Button Chart.....page 109

This lists all Tyros3 displays called up from the panel controls, according to their hierarchical structure. You can easily see the relationship of the various functions and quickly locate desired information.

- The photos of the harpsichord, bandneon, hackbrett, music box, dulcimer and cimbalom, shown in the displays of the Tyros3, are courtesy of the Gakki Shiryokan (Collection for organology), Kunitachi College of Music.
- The following instruments, shown in the displays of the Tyros3, are on display at the Hamamatsu Museum of Musical Instruments:  
balafon, gender, kalimba, kanoon, santur, gamelan gong, harp, hand bell, bagpipe, banjo, carillon, mandolin, oud, pan flute, pungi, rabab, shanai, sitar, steel drum, tambra.
- This product is manufactured under license of U.S. Patents No.5231671, No.5301259, No.5428708, and No.5567901 from IVL Audio Inc.
- The bitmap fonts used in this instrument have been provided by and are the property of Ricoh Co., Ltd.
- This product utilizes NF, an embedded Internet browser from ACCESS Co., Ltd. NF is used with the patented LZW, licensed from Unisys Co., Ltd. NF may not be separated from this product, nor may it be sold, lent or transferred in any way. Also, NF may not be reverse-engineered, reverse-compiled, reverse-assembled or copied. This software includes a module developed by the Independent JPEG Group.
- The illustrations and LCD screens as shown in this manual are for instructional purposes only, and may appear somewhat different from those on your instrument. Note that all display examples shown in this manual are in English.
- Some of the preset songs have been edited for length or arrangement, and may not be exactly the same as the original.
- This product incorporates and bundles computer programs and contents in which Yamaha owns copyrights or with respect to which it has license to use others' copyrights. Such copyrighted materials include, without limitation, all computer software, style files, MIDI files, WAVE data, musical scores and sound recordings. Any unauthorized use of such programs and contents outside of personal use is not permitted under relevant laws. Any violation of copyright has legal consequences. DON'T MAKE, DISTRIBUTE OR USE ILLEGAL COPIES.
- This product can be used to import/record analog audio signals through the LINE IN/MIC, and can also record your keyboard performance and playback of MIDI song data into digital audio signals of WAV format. If you use any copyrighted material in your recording, even if you add your own performance, the copying or public playback of that material, other than for your own personal use, is strictly prohibited.
- This device is capable of using various types/formats of music data by optimizing them to the proper format music data for use with the device in advance. As a result, this device may not play them back precisely as their producers or composers originally intended.
- Copying of the commercially available musical data including but not limited to MIDI data and/or audio data is strictly prohibited except for your personal use.
- The company names and product names in this manual are the trademarks or registered trademarks of their respective companies.

ACCESS™

# Contents

Included Accessories.....	6
Main Features .....	7
About the Manuals.....	8
How to use this Owner's Manual.....	9
<b>Panel Controls and Terminals</b>	<b>12</b>
<b>Starting Up</b>	<b>16</b>
Power Supply .....	16
Turning the Power On.....	16
Raising the Display Panel.....	17
Changing the Display Language.....	17
Entering the Owner Name in the Opening Display .....	18
Playing the Demos .....	19
<b>Basic Operations</b>	<b>20</b>
Display-based Controls .....	20
The Messages Shown in the Display.....	23
Instant Selection of the Displays—Direct Access.....	23
Basic Displays (Main Display and File Selection Display) .....	24
File/Folder Operations in the File Selection Display .....	30
Restoring the Factory-programmed Settings.....	35
Data Backup .....	35
<b>1 Voices – Playing the Keyboard –</b>	<b>36</b>
Playing Preset Voices.....	36
Transposing the Pitch of the Keyboard .....	41
Using the Wheels .....	41
Adding Articulation Effects to Super Articulation Voices .....	42
Applying Voice Effects .....	44
Creating Your Original Organ Flutes Voices.....	46
<b>2 Styles – Playing Rhythm and Accompaniment –</b>	<b>48</b>
Playing a Style with the Auto Accompaniment.....	48
Operating Style Playback .....	50
Calling up the Panel Settings to Match the Style (Repertoire).....	52
Appropriate Panel Settings for the Selected Style (One Touch Setting) .....	53
Turning Style Parts On/Off and Changing Voices .....	54
Adjusting the Volume Balance Between the Style and Keyboard.....	55
<b>3 Songs – Recording Your Performances and Creating Songs –</b>	<b>57</b>
Creating a Song (Quick Recording) .....	57
Playback of Songs.....	59
Displaying Music Notation (Score) .....	61
Displaying Lyrics (Text).....	61
Using Song Position Markers .....	62
Turning Song Channels On/Off.....	63
<b>4 Multi Pads – Adding Musical Phrases to Your Performance –</b>	<b>64</b>
Playing the Multi Pads .....	64
Using the Multi Pad Synchro Start Function .....	65
Using Chord Match.....	65
<b>5 Music Finder – Calling Up Ideal Setups for Your Music –</b>	<b>66</b>
Selecting the Desired Music Genre from the Record List .....	66
Searching the Record .....	67



# Panel Controls and Terminals

## ■ Top Panel

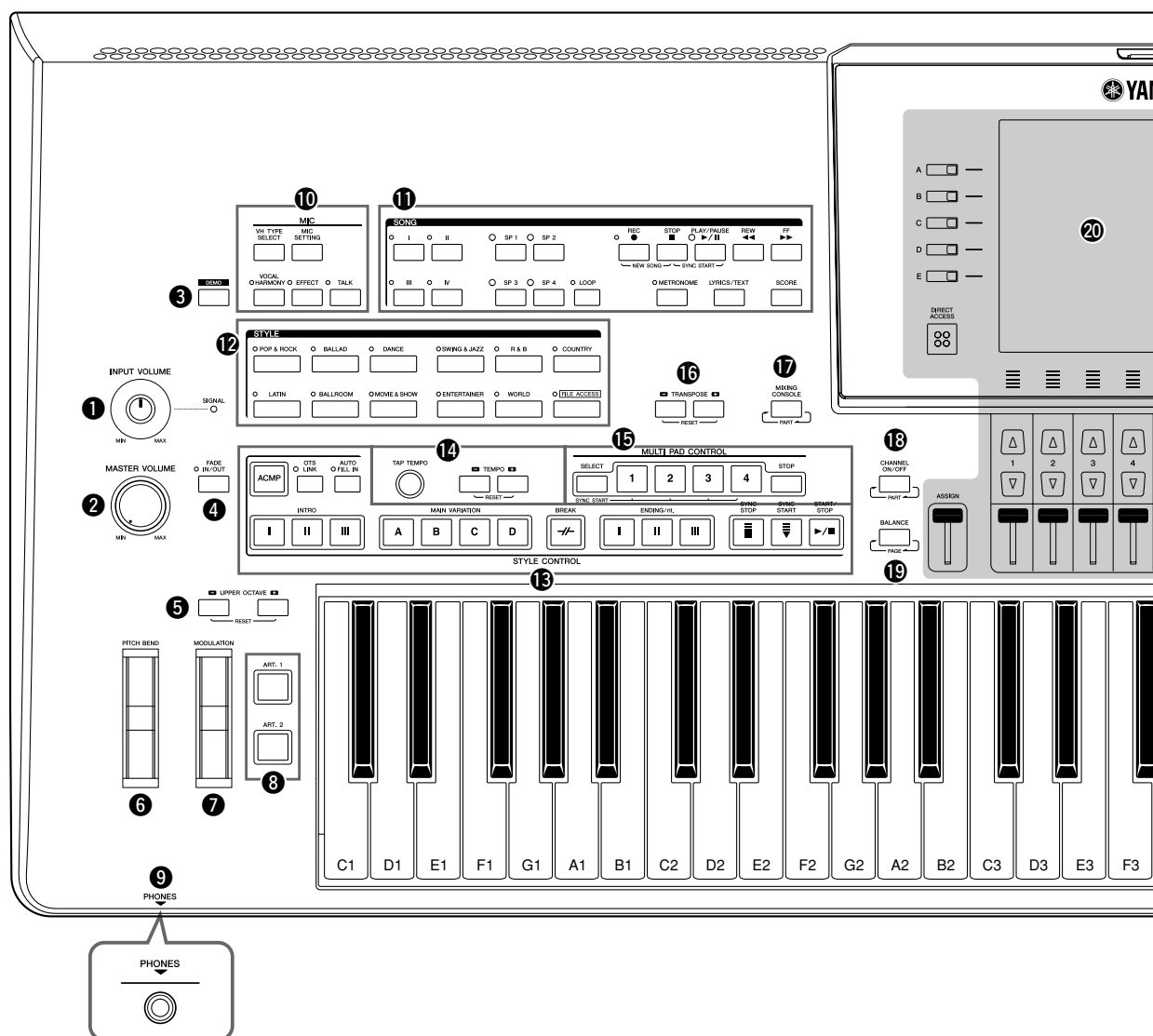

- 1 INPUT VOLUME control** ..... Page 91  
Adjusts the input volume from the LINE IN/MIC jack.
- 2 MASTER VOLUME control** ..... Page 16  
Adjusts the overall volume.
- 3 DEMO button** ..... Page 19  
Plays the Demos.
- 4 FADE IN/OUT button** ..... Page 51  
Controls fade in/out of the Style/Song playback.
- 5 UPPER OCTAVE buttons**..... Page 41  
Shifts the pitch of the keyboard in octave steps.
- 6 PITCH BEND wheel** ..... Page 41  
Bends the pitch of the keyboard played sound up or down.
- 7 MODULATION wheel**..... Page 42  
Applies a vibrato effect.
- 8 ART. 1/ART. 2 buttons**..... Page 42  
Controls Super Articulation Voices.
- 9 PHONES jack** ..... Page 15  
For connecting a pair of headphones.
- 10 MIC buttons** ..... Page 92  
Adds some effects to Microphone input.
- 11 SONG buttons** ..... Page 57  
Selects a Song and controls Song playback.
- 12 STYLE category selection buttons**..... Page 48  
Selects a Style.
- 13 STYLE CONTROL buttons** ..... Page 50  
Controls Style playback.
- 14 TEMPO buttons** ..... Page 51  
Controls the tempo for Style, Song and Metronome playback.
- 15 MULTI PAD CONTROL buttons**..... Page 64  
Selects and plays a rhythmic or melodic Multi Pad phrase.
- 16 TRANSPOSE buttons** ..... Page 41  
Transposes the pitch in semitone steps.

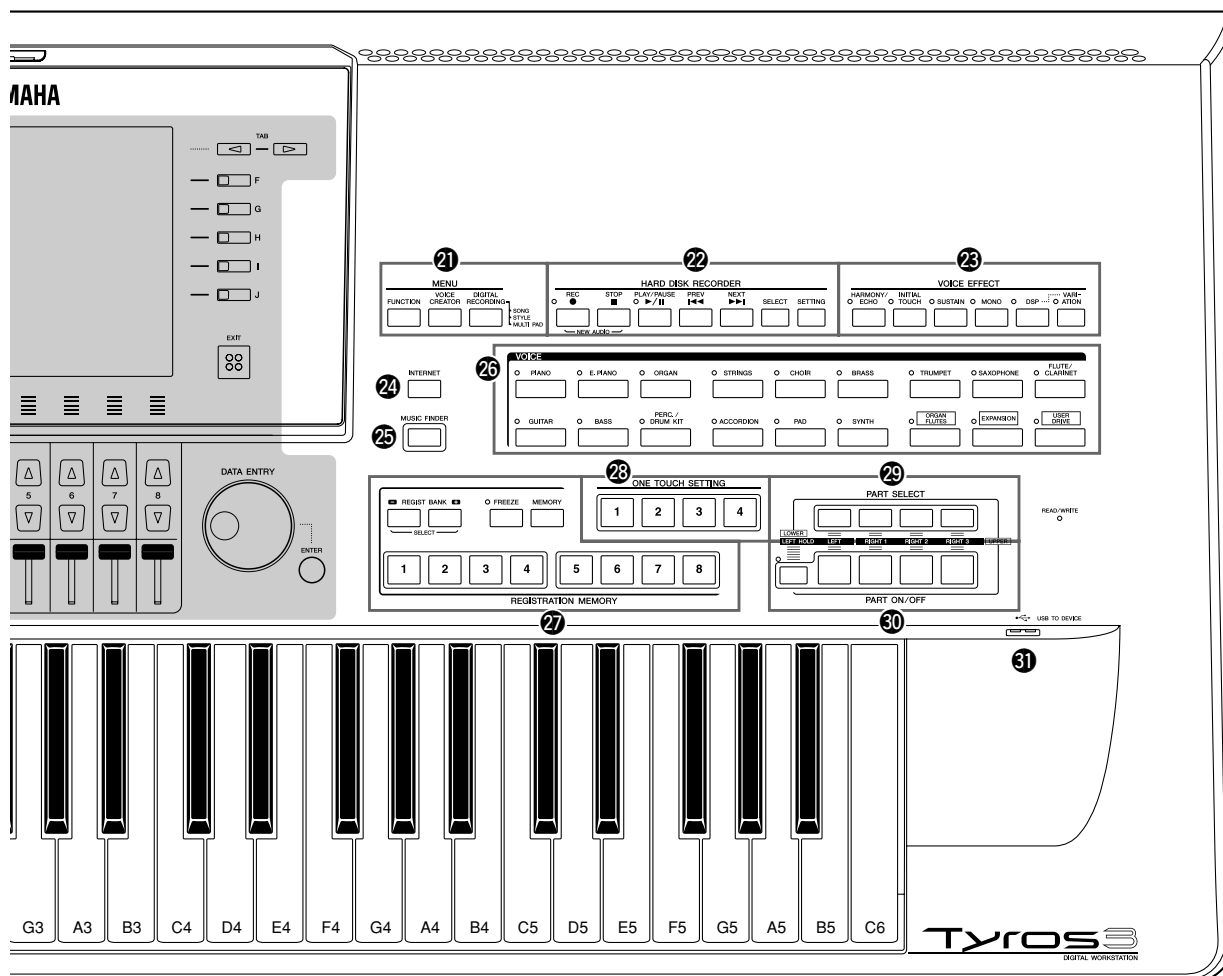

- 17 MIXING CONSOLE button** ..... Page 78  
Controls over aspects of keyboard, Style and Song parts.
- 18 CHANNEL ON/OFF button** ..... Pages 54, 63  
Turns channels of Style/Song on or off.
- 19 BALANCE button**..... Pages 55, 75  
Adjusts the volume balance among each part.
- 20 LCD and related controls** ..... Page 20
- 21 MENU buttons (See Reference Manual on website.)**  
Lets you make some advanced settings and create your original Voices, Styles, Songs and Multi Pads.
- 22 HARD DISK RECORDER buttons** ..... Page 71  
Records your performance in audio format.
- 23 VOICE EFFECT buttons**..... Page 44  
Applies some effects to the keyboard performance.
- 24 INTERNET button**..... Page 83  
Accesses to Internet website.
- 25 MUSIC FINDER button**.....Page 66  
Calls up the appropriate panel settings for desired music genre.
- 26 VOICE category selection buttons** .....Page 36  
Selects a Voice.
- 27 REGISTRATION MEMORY buttons** .....Page 68  
Registers and recalls panel setups.
- 28 ONE TOUCH SETTING buttons**.....Page 53  
Calls up the appropriate panel settings for the Style.
- 29 PART SELECT buttons** .....Page 38  
Selects a keyboard part.
- 30 PART ON/OFF buttons** .....Page 38  
Turns the keyboard parts on or off.
- 31 USB TO DEVICE terminal** .....Page 94  
For connecting USB storage device.

## ■ Rear Panel

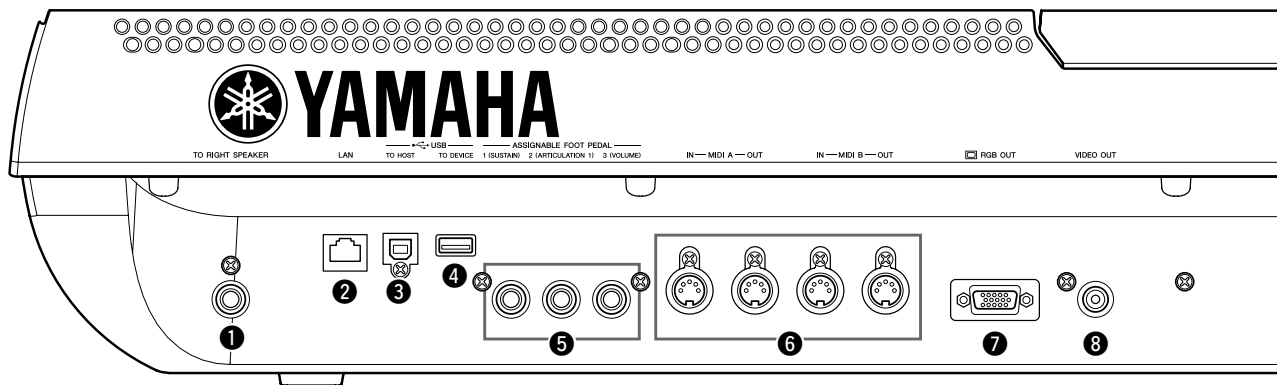

- |   |   |
|---|---|
| <p><b>1 TO RIGHT SPEAKER jack</b>.....Page 100<br/>For connecting an optional set of speakers.</p> <p><b>2 LAN terminal</b>.....Page 82<br/>For connecting a LAN cable.</p> <p><b>3 USB TO HOST terminal</b> .....Page 96<br/>For connecting to computer.</p> <p><b>4 USB TO DEVICE terminal</b>.....Page 94<br/>For connecting a USB storage device.</p> | <p><b>5 ASSIGNABLE FOOT PEDAL jacks</b>.....Page 93<br/>For connecting Footswitches and/or Foot controllers.</p> <p><b>6 MIDI terminals</b>.....Page 98<br/>For connecting external MIDI devices.</p> <p><b>7 RGB OUT terminal</b>.....Page 90<br/>For connecting a computer monitor.</p> <p><b>8 VIDEO OUT terminal</b> .....Page 90<br/>For connecting a television or video monitor.</p> |
|---|---|

### Attaching the Music Rest

Check carefully that all parts (two music rest brackets and one music rest) are included before following the instructions below.

- 1** Attach the two music rest brackets to the inside slot on the rear panel.
- 2** Attach the music rest to the brackets.

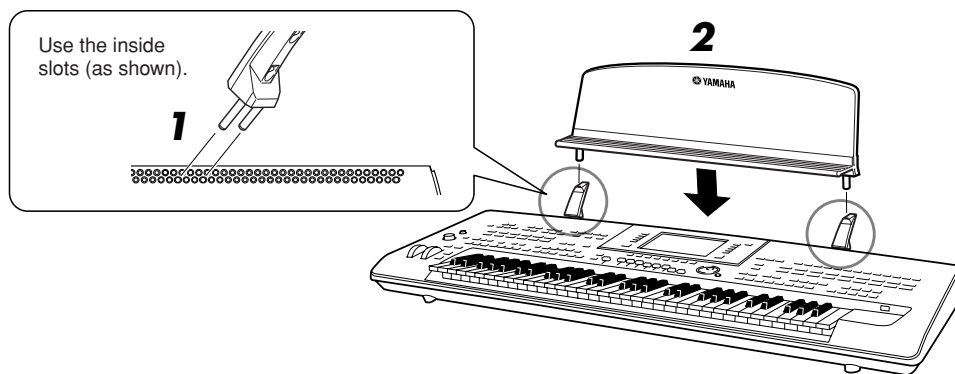

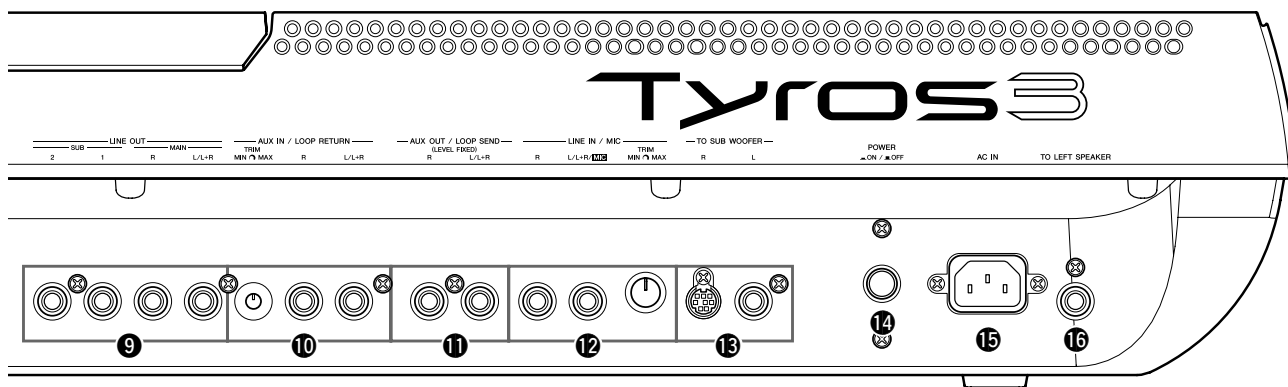

- 9 LINE OUT jacks**..... Page 88  
For connecting external audio devices.
- 10 AUX IN/LOOP RETURN jacks** ..... Page 89  
For connecting external audio devices.
- 11 AUX OUT/LOOP SEND jacks**..... Page 89  
For connecting external audio devices.
- 12 LINE IN/MIC jacks**..... Pages 89, 91  
For connecting microphone, electronic guitar, etc.
- 13 TO SUB WOOFER jacks** .....Page 101  
For connecting an optional set of speakers.
- 14 POWER ON/OFF switch**.....Page 16  
Turns the Tyros3's power on or off.
- 15 AC IN terminal**.....Page 16  
For connecting the supplied power cord.
- 16 TO LEFT SPEAKER jack**.....Page 100  
For connecting an optional set of speakers.

## Connecting Headphones or Optional Speaker

Since the Tyros3 has no built-in speakers, you'll need to monitor the sound of the instrument by using external equipment. Connect a set of headphones to the [PHONES] jack or use the speaker system, such as the optional TRS-MS02 speakers. For instructions on installing the TRS-MS02 to the Tyros3, see page 100. For instructions on connecting other speakers, see page 88.

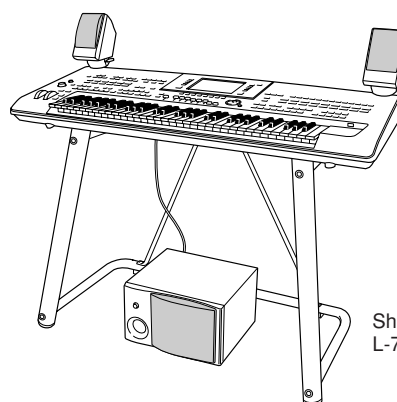
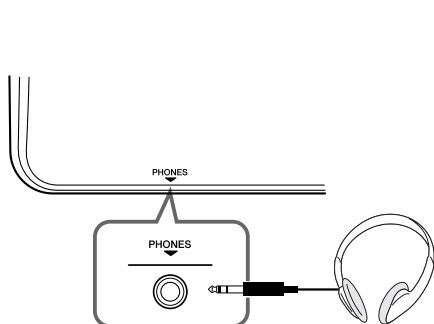

Shown here is the optional L-7S Keyboard Stand.

# Starting Up

This section contains information about setting up your Tyros3 and preparing to play. Be sure to read through this section carefully before turning the power on.

## Power Supply

- 1 Make sure the POWER ON/OFF switch on the Tyros3 is set to OFF.
- 2 Connect the supplied power cord to the AC IN terminal on the instrument's rear panel.

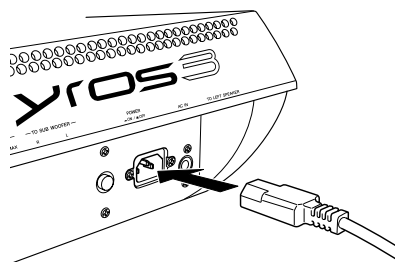

- 3 Connect the other end of the power cord to an AC outlet.

Make sure your Tyros3 meets the voltage requirement for the country or region in which it is being used.

### **⚠ WARNING**

Make sure your Tyros3 is rated for the AC voltage supplied in the area in which it is to be used (as listed on the bottom). Connecting the unit to the wrong AC supply can cause serious damage to the internal circuitry and may even pose a shock hazard!

### **⚠ WARNING**

Use only the AC power cord supplied with the Tyros3. If the supplied cord is lost or damaged and needs to be replaced, contact your Yamaha dealer. The use of an inappropriate replacement can pose a fire and shock hazard!

### **⚠ WARNING**

The type of AC power cord provided with the Tyros3 may be different depending on the country in which it is purchased (a third prong may be provided for grounding purposes). Improper connection of the grounding conductor can create the risk of electrical shock. Do NOT modify the plug provided with the Tyros3. If the plug will not fit the outlet, have a proper outlet installed by a qualified electrician. Do not use a plug adapter which defeats the grounding conductor.

## Turning the Power On

Before you switch your Tyros3 on or off, make sure that the MASTER VOLUME and INPUT VOLUME are set to "MIN" and the volume of any connected audio equipment is turned down.

- 1 Press the [POWER ON/OFF] switch on the rear panel.
- 2 Use the [MASTER VOLUME] dial to adjust the volume to an appropriate level.

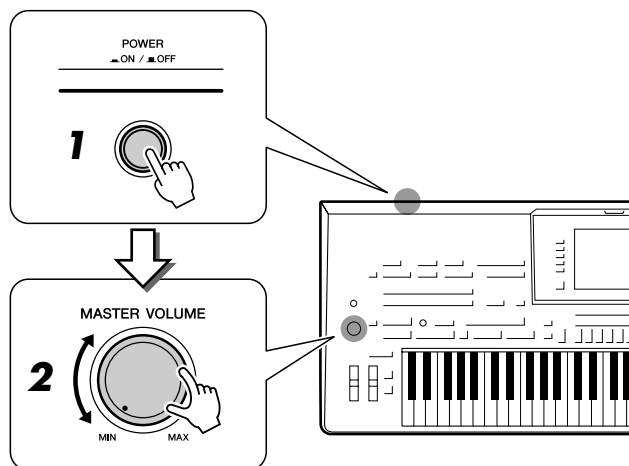

### **⚠ CAUTION**

In order to avoid possible damage to the speakers or other connected electronic equipment, always switch on the power of the Tyros3 before switching on the power of the amplified speakers or mixer and amplifier. Likewise, always switch off the power of the Tyros3 after switching off the power of the amplified speakers or mixer and amplifier.

### **⚠ CAUTION**

Even when the POWER switch is turned off, electricity is still flowing to the instrument at the minimum level. When you are not using the instrument for a long time, make sure you unplug the power cord from the wall AC outlet.



## Raising the Display Panel

Unfasten the lock located at the back of the display panel. Then lift the panel and tilt it toward you. The panel will click as you tilt in back; these clicks are the four latched positions. Once you've set it to a satisfactory position, release the panel. It will gently fall back to the nearest latched position.

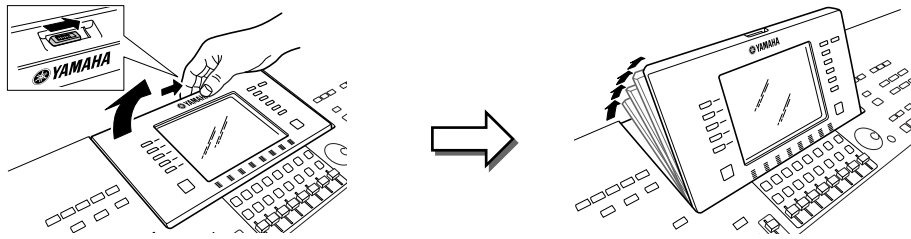

To return the panel to its closed and locked position, gently pull it back toward you until the position is vertical, then push it down until it locks into place.

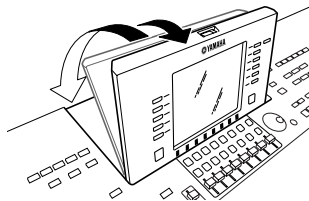

### **CAUTION**

Looking at the display for a long period of time in the dark may cause eyestrain or damage to your eyesight. Make sure to use the instrument with as much ambient light as possible and also take adequate breaks and rest from use.

## Changing the Display Language

This determines the language used in the display for messages, file names, and character input.

### 1 Call up the operation display.

[FUNCTION] → [I] UTILITY → TAB [◀|▶] OWNER

### **NOTE**

Throughout this manual, arrows are used in the instructions, indicating in shorthand the process of calling up certain displays and functions.

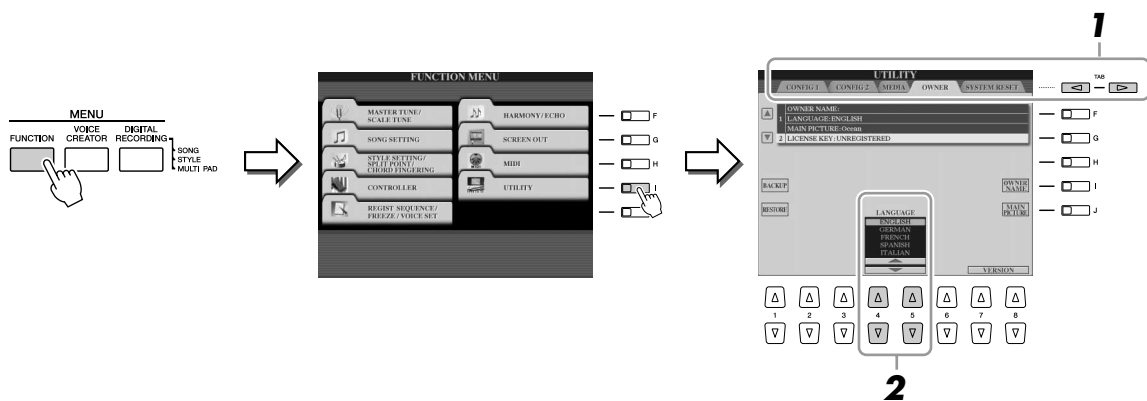

### 2 Use [4 ▲▼]/[5 ▲▼] buttons to select the desired language.

## Entering the Owner Name in the Opening Display

You can have your name appear in the opening display (the display that appears when the power is turned on).

### 1 Call up the operation display.

[FUNCTION] → [I] UTILITY → TAB [◀|▶] OWNER

### 2 Press the [I] (OWNER NAME) button to call up the Owner Name display.

Refer to page 34 for character-entry details.

#### NOTE

If desired, you can also change the background picture in the Main display by pressing the [J] (MAIN PICTURE) button in step 2 here.

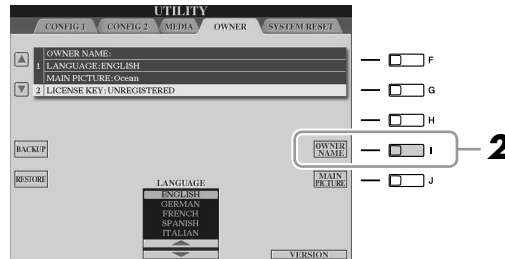

#### Display the version number

To check the version number of this instrument, press the [7 ▲▼]/[8 ▲▼] (VERSION) buttons in the display in step 2 above. Press the [EXIT] button or [8 ▲▼] button to return to the original display.

## Playing the Demos

The Demos provide helpful, easy-to-understand introductions to the Tyros3 features and functions as well as sound demonstrations.

- 1 Press the [DEMO] button to start the Demos.

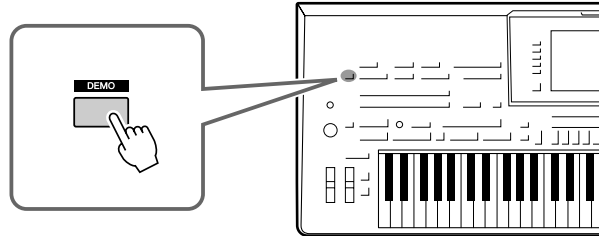

Overview Demo will play back continuously, calling up the various displays in sequence.

- 2 Press the [7 ▲▼]/[8 ▲▼] (SKIP OVERVIEW) buttons in the Demo display to call up the specific Demo menu.

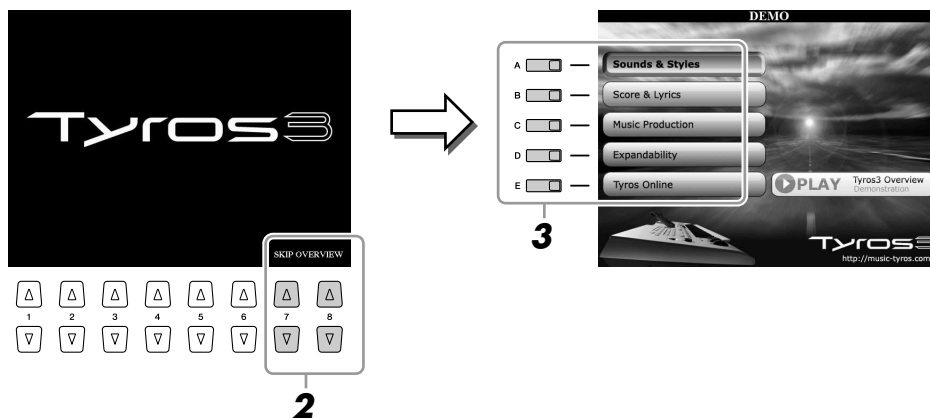

- 3 Press one of the [A]–[E] buttons to show a specific Demo.

The sub menus are shown at the bottom of the display. Press one of the [1 ▲▼]–[8 ▲▼] buttons corresponding to the sub menu.



**NOTE**

To return to the highest level menu, press the [EXIT] button.

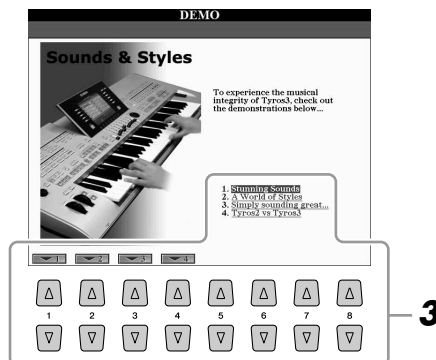

- 4 Press the [EXIT] button several times to exit from the Demos.

# Basic Operations

## Display-based Controls

The Tyros3 features an exceptionally large and easy-to-understand display. It provides comprehensive at-a-glance information on all current settings, and gives you convenient, intuitive control over the Tyros3's functions.

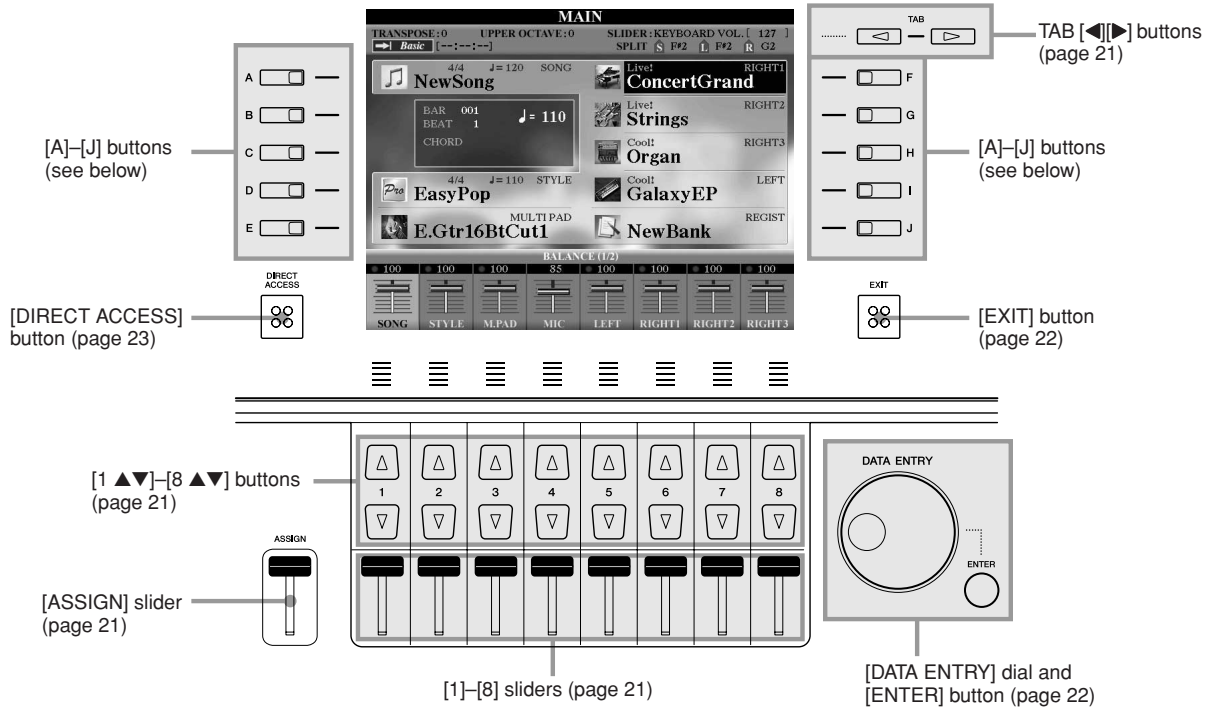

## [A]–[J] buttons

The [A]–[J] buttons are used to select the corresponding menu.

### ● Example 1

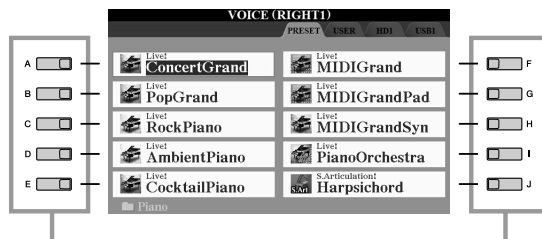

In the File Selection display (page 25), the [A]–[J] buttons can be used to select the corresponding respective files.

### ● Example 2

The [A] and [B] buttons are used to move the cursor up or down.

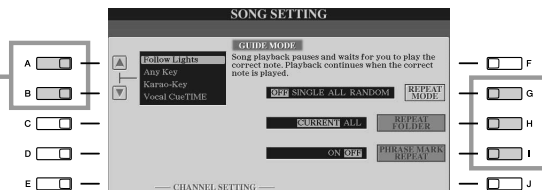

The [G], [H] and [I] buttons are used to select the corresponding parameter.

## TAB [◀][▶] buttons

These buttons are used mainly to change the Pages of displays that have “tabs” at the top.



## [ASSIGN] slider

When the Footage Page of the Organ Flute Voice is shown, this slider is used to adjust the footage lever of 16' (page 46).  
 When other displays are shown, this slider is used to adjust the keyboard volume (page 55) directly during your performance, by default.

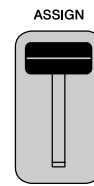

**NOTE**  
 You can freely change the function assigned to the [ASSIGN] slider:  
 [FUNCTION] → [D] CONTROLLER → TAB [◀][▶] ASSIGN SLIDER.

## [1]–[8] sliders

In the footage Page of the Organ Flute Voice, these sliders are used to adjust the footages.  
 In other displays, these sliders are used to adjust settings (up or down correspondingly) for functions shown directly above them, only when the menu is shown in a knob or slider shape.

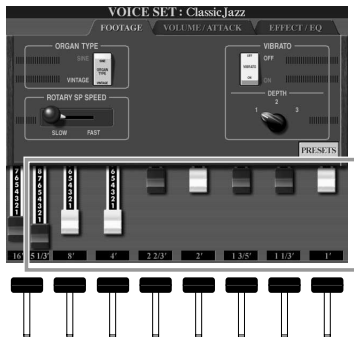

Footage levers of 5 1/3'–1' can be adjusted by the [1]–[8] sliders.

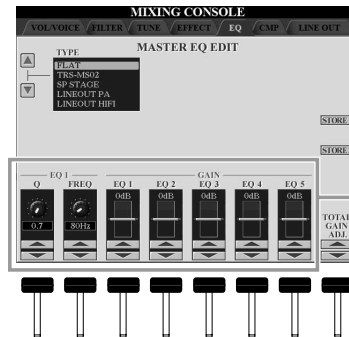

Knob or slider in the display can be adjusted by the corresponding [1]–[8] slider.

## [1 ▲▼]–[8 ▲▼] buttons

The [1 ▲▼]–[8 ▲▼] buttons are used to make selections or adjust settings (up or down correspondingly) for functions shown directly above them.



If a menu appears in this section of the display, use the [1 ▲]–[8 ▲] buttons.

If a parameter appears in this section of the display, use the [1 ▼]–[8 ▼] buttons.

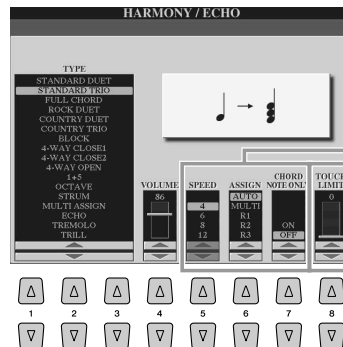

If list of the menu appears, use the [1 ▲▼]–[8 ▲▼] button to select the desired item.

If a parameter appears in slider (or knob) form, use the [1 ▲▼]–[8 ▲▼] button to adjust the value.

## [DATA ENTRY] dial and [ENTER] button

Depending on the selected LCD display, the [DATA ENTRY] dial can be used in the following two ways.

### ● Selecting files (Voice, Style, Song, and so on)

When one of the File Selection displays (page 25) is shown, you can use the [DATA ENTRY] dial and the [ENTER] button to select a file (Voice, Style, Song, and so on).

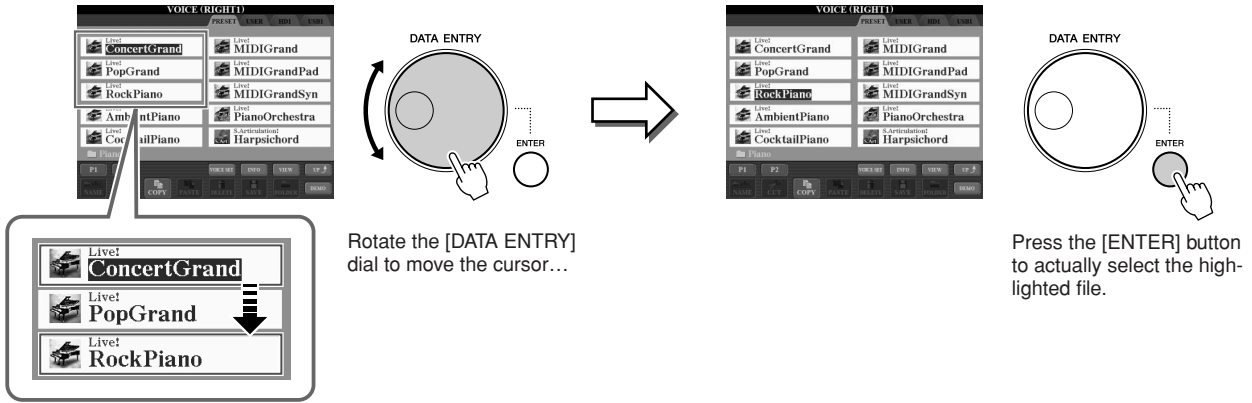

### ● Adjusting the parameter values

In addition to using sliders, you can conveniently use the [DATA ENTRY] dial in tandem with the [1 ▲▼]–[8 ▲▼] buttons to adjust parameters indicated in the display.

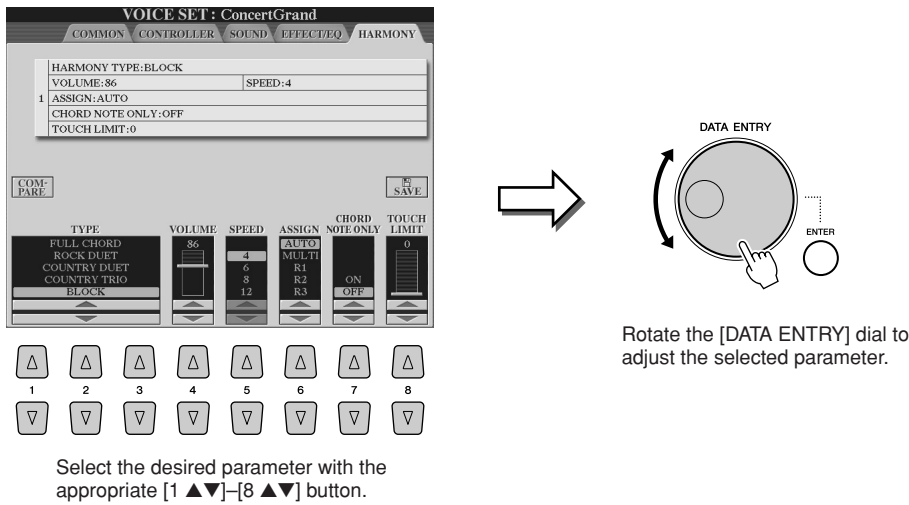

This convenient technique also works well with pop-up parameters such as Tempo and Transpose. Simply press the appropriate button (ex., TEMPO [+]), then rotate the [DATA ENTRY] dial and press [ENTER] to close the window.

## [EXIT] button

No matter where you are in the Tyros3 display hierarchy, the [EXIT] button will return you to the next highest level or to the previously indicated display.

Press the [EXIT] button several times returns the Tyros3 to the default Main display (page 24)—the same display that appears when the power is turned on.



## The Messages Shown in the Display

A message (information or confirmation dialog) sometimes appears on the screen to facilitate operation. When the message appears, simply press the appropriate button.



## Instant Selection of the Displays—Direct Access

With the convenient Direct Access function, you can instantly call up the desired display—with just a single additional button press.

### 1 Press the [DIRECT ACCESS] button.

A message appears in the display prompting you to press the appropriate button.

### 2 Press the button (or move the slider, wheel or connected pedal) corresponding to the desired setting display to instantly call up that display.

For example, pressing the [ACMP] button calls up the display in which the Chord Fingering type for accompaniment playback can be set.

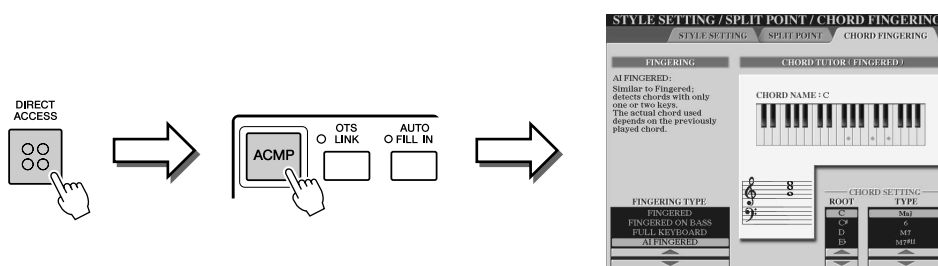

Refer to the Data List for a list of the displays that can be called up with the Direct Access function. The Data List is available at the Yamaha website. (See page 8.)

## Basic Displays (Main Display and File Selection Display)

There are two basic display types—Main display and File Selection display. Here are explanations of each display segment and its basic operation.

### Main Display

The Main display shows the current basic settings such as the currently selected Voice and Style, allowing you to see them at a single glance. The Main display is the one you'll usually see when you play the keyboard.

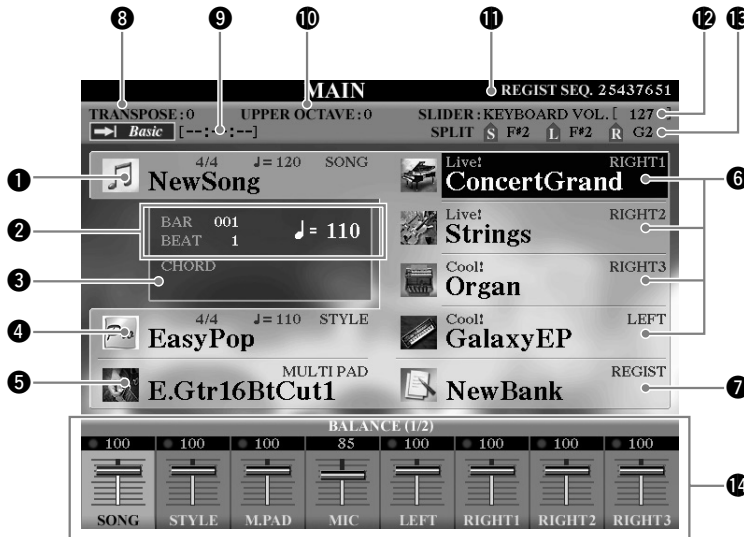

#### NOTE

Here's a convenient way to return to the Main display from any other display: Simply press the [DIRECT ACCESS] button, then the [EXIT] button.

#### NOTE

When turning on the power, a message may appear at top left of the Main display indicating the Expansion Voices are being loaded from the installed hard disk or USB storage device(s).

#### 1 Song name and related information

Displays the currently selected Song name, time signature and tempo.

If the Song contains the chord data, the current chord name will be displayed in the "CHORD" segment (see 3 below).

Pressing the [A] button calls up the Song Selection display (page 59).

#### 2 BAR/BEAT/TEMPO

Displays the current position (bar/beat/tempo) in Style playback or Song playback.

#### 3 Current chord name

If the [ACMP] button is set to On, the chord specified in the chord section of the keyboard will be displayed.

#### 4 Style name and related information

Displays the currently selected Style name, time signature and tempo. Pressing the [D] button calls up the Style Selection display (page 48).

#### 5 Multi Pad Bank name

Displays the names of the selected Multi Pad Banks. Pressing the [E] button calls up the Multi Pad Bank Selection display (page 64).

#### 6 Voice name

Displays the Voice names currently selected for RIGHT 1, RIGHT 2, RIGHT 3 and LEFT.

Pressing one of the [F], [G], [H] and [I] buttons calls up the Voice Selection display for each part (page 37).

#### 7 Registration Memory Bank name

Displays the currently selected Registration Memory Bank name and Registration Memory number.

Pressing the [J] button calls up the Registration Memory Bank Selection display (page 69).



- 8 Transpose**  
Displays the amount of transposition in semitone units (page 41).
- 9 Audio Song**  
Displays the Audio Song title selected in the Hard Disk Recorder function (page 71).  
The “Basic/Playlist” indicator status depends on the active mode.
- 10 Upper Octave**  
Displays the amount that the octave value is shifted (page 41).
- 11 Registration Sequence**  
Appears when the Registration Sequence is active.
- 12 ASSIGN slider function**  
Displays the function (parameter) assigned to the ASSIGN slider and its value (page 21).
- 13 Split Point**  
Displays the Split Point positions (page 38).
- 14 Volume Balance**  
Displays the volume balance among the parts.  
Adjust the volume balance among the parts by using the [1 ▲▼]–[8 ▲▼] buttons or sliders.

## File Selection Display

The File Selection display appears when you press one of the buttons shown below. From here you can select Voices, Styles, and other data.

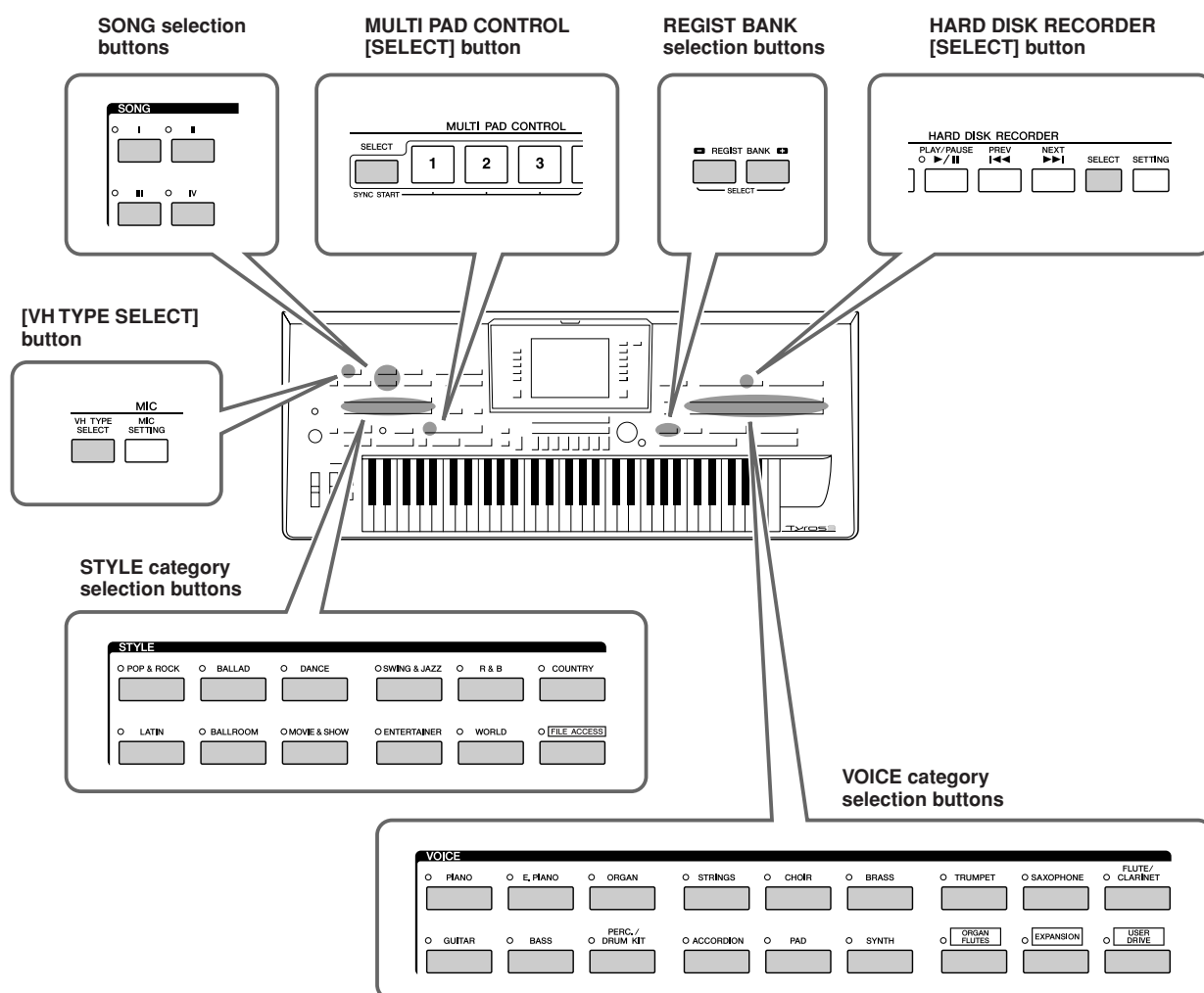

## ■ File Selection Display Configuration

### ● Location (drive) of data



- **PRESET** ..... Location where pre-programmed (preset) data is stored.
- **USER** ..... Location where recorded or edited data is saved.
- **HD** ..... Location where data on a hard disk drive installed to the Tyros3 is saved.
- **USB** ..... Location where data on USB storage device (USB flash memory, floppy disk, etc.) is saved. This appears only when USB storage device(s) is connected to the [USB TO DEVICE] terminal (page 94).

**NOTE**

Hereafter in this manual, any USB storage device such as USB flash memory, floppy disk drive, etc. will be referred to as "USB storage device."

### ● Data files and folders

The data, both pre-programmed and your own original, are saved as "files."  
You can drop files into a folder (except in Preset).

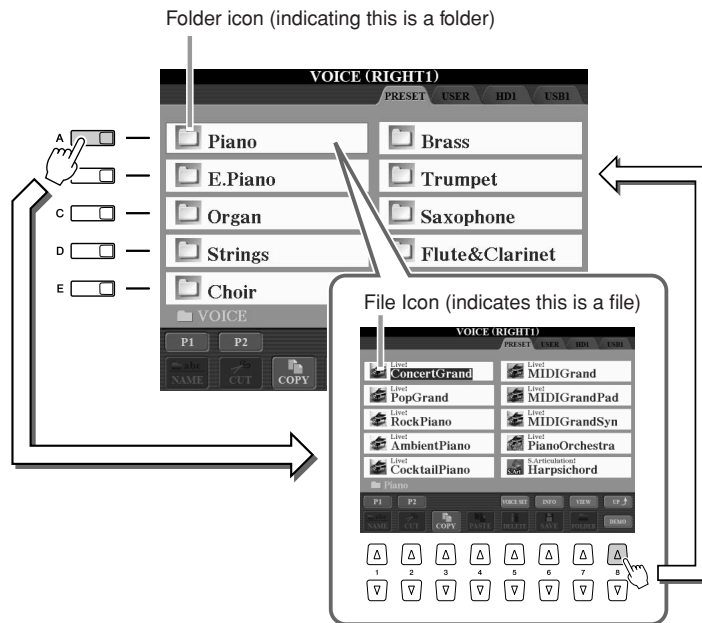

## ■ File Selection Display Basic Operation

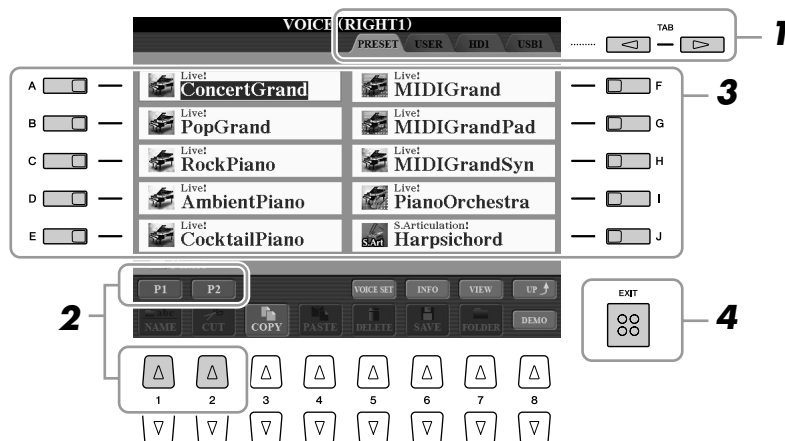

**1** Select the tab (PRESET, USER, etc.) containing the desired file by using the TAB [◀][▶] buttons.

**2** Select the page containing the desired file by using the corresponding buttons ([1 ▲], [2 ▲], etc.).

The number of pages shown varies depending on the Selection display of the Voices/Songs/Styles/Multi Pads. Press the corresponding button to “P1, P2 ...” in the display. When other pages follow, the “Next” button appears, and for the previous page, the “Prev.” button appears.

**3** Press one of the [A]–[J] buttons to select the file.

You can also select the file by using the [DATA ENTRY] dial, then press the [ENTER] button to execute.

**4** Press the [EXIT] button to return to the previous display.

### Closing the current folder and calling up the next highest level folder

To close the current folder and call up the next highest level folder, press the [8 ▲] (UP) button.

### Example of the PRESET Voice Selection display

The PRESET Voice files are categorized and contained in appropriate folders.

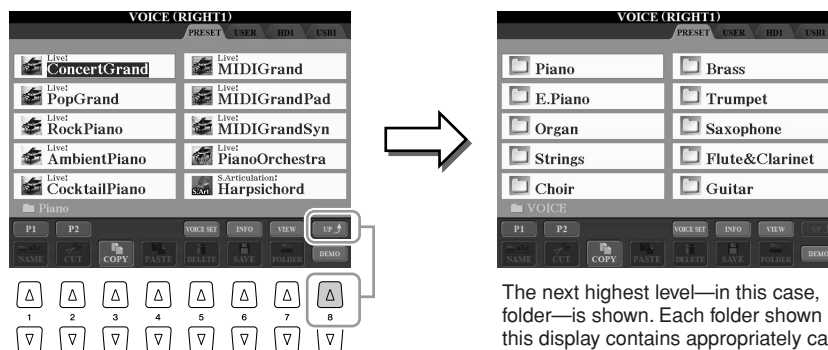

This display shows the Voice files in a folder.

The next highest level—in this case, folder—is shown. Each folder shown in this display contains appropriately categorized Voices.

## ■ Changing the File Selection Display View

The File Selection display actually has two different view types. One is Normal View, which we've seen up until this point. The other is List View, which lets you open files according to their numbers. Since the Tyros3 has many files spread out over several pages, number input in List View may be quicker and more convenient—providing you know the number of the file.

Switch between the two types by pressing the [7 ▲] (VIEW) button.

File Selection display—Normal View (page 27)



File Selection display—List View (see below)

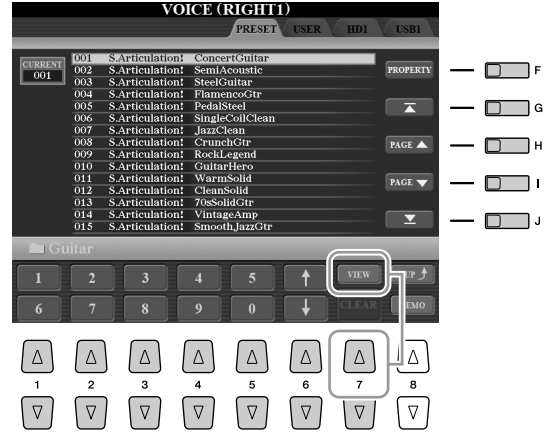

[F]	PROPERTY	Shows the property of the drive/folder/file.
[G]	(TOP)	Moves the cursor to the top of this page (path).
[H]/[I]	PAGE UP/DOWN	Scrolls up/down through the file list on this page (path).
[J]	(END)	Moves the cursor to the end of this page (path).
[1 ▲▼]– [5 ▲▼]	(Number Input)	Input the desired number. To select Voice number 046, for example, press the buttons corresponding to “4” and “6” in sequence, and press the [ENTER] button. Entering one-digit numbers is done in the same way.
[6 ▲▼]	(UP/DOWN)	Selects the next or previous file.
[7 ▼]	CLEAR	Press this to cancel the number you've input.

### Memorizing Song/Style paths

The File Selection display for Songs and Styles lets you memorize the path of specific Song/Style to one of the panel buttons. Even if your data is scattered across the drive in a complex hierarchy of folders and paths, you can instantly call up a specific file—no matter how deeply hidden—with a single button-press.

- In the List View display, select the Song/Style to be memorized, then press the [E] (MEMORY) button. A message appears prompting you to select one of the SONG/STYLE buttons to which the path is to be memorized.

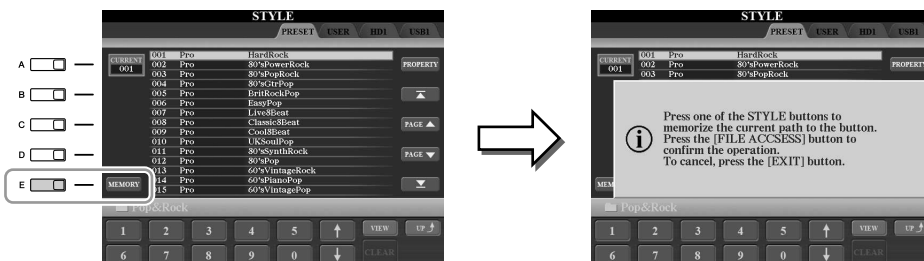

- Press one of the SONG [I]–[IV] buttons (for Songs) or one of the STYLE category selection buttons other than [FILE ACCESS] button (for Styles). The path is memorized to the selected button.
- Exit from the Song/Style Selection display by pressing the [EXIT] button, then call up the memorized path.

**To call up the memorized path for a Song**, simply press the appropriate SONG button selected in step 2.  
**To call up the memorized path for a Style**, first turn on the [FILE ACCESS] button, then press the appropriate STYLE button selected in step 2.

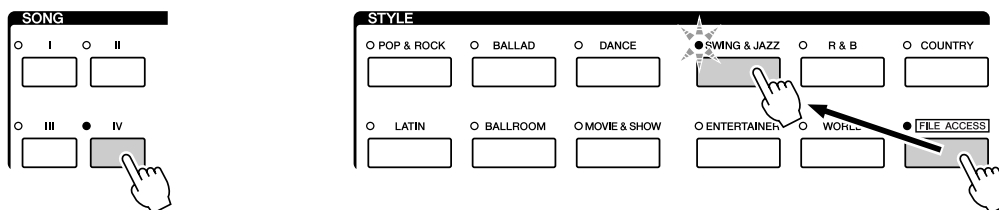

# File/Folder Operations in the File Selection Display

From the File Selection display, you can save and manage your data files as described below.

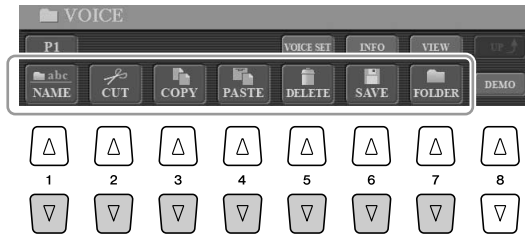

- [1 ▼] Renaming Files/Folders ..... page 33
- [2 ▼]/[4 ▼] Moving Files (Cut & Paste)..... page 32
- [3 ▼]/[4 ▼] Copying Files/Folders (Copy & Paste)..... page 31
- [5 ▼] Deleting Files/Folders..... page 32
- [6 ▼] Saving Files..... see below
- [7 ▼] Creating a New Folder..... page 33

## Saving Files

This operation lets you save your original data (such as Songs and Voices you've created) to a file.

**1** After you've created your original data (Voice, Style, Song, etc.) in the relevant display, press the [SAVE] display button.

The File Selection display for the corresponding data appears. Keep in mind that the Save operation is executed from the File Selection display.

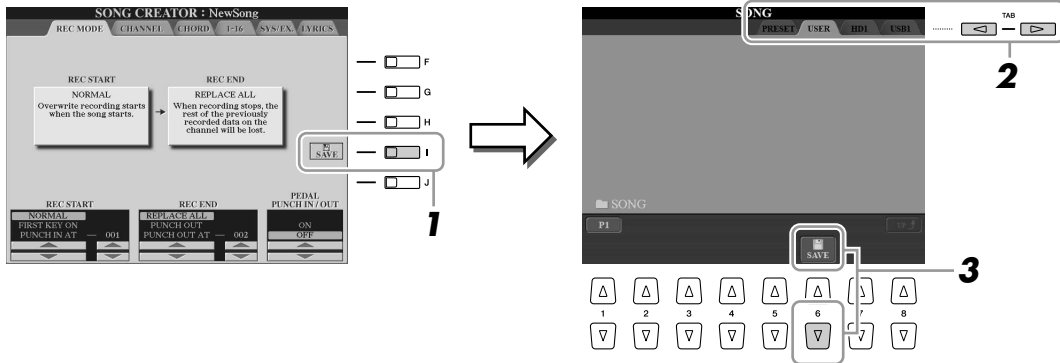

**2** Select the appropriate tab (USER, HD or USB) to which you want to save the data by using the TAB [◀][▶] buttons.

**3** Press the [6 ▼] (SAVE) button to call up the file naming display.



**4 Enter the file name (page 34).****5 Press the [8 ▲] (OK) button to save the file.**

If you want to cancel the Save operation, press the [8 ▼] (CANCEL) button. The saved file will be automatically located at the appropriate position among the files in alphabetical order.

## Copying Files/Folders (Copy & Paste)

---

This operation lets you copy a file/folder and paste it to another location (folder).

**1 Call up the display containing the file/folder you want to copy.****2 Press the [3 ▼] (COPY) button to copy the file/folder.**

The pop-up window for the Copy operation appears at the bottom of the display.

**3 Press one of the [A]–[J] buttons corresponding to the desired file/folder.**

To cancel the selection, press the same [A]–[J] button again.

Press the [6 ▼] (ALL) button to select all files/folders indicated on the current display including the other pages. To cancel the selection, press the [6 ▼] (ALL OFF) button again.

**4 Press the [7 ▼] (OK) button to confirm the file/folder selection.**

To cancel the Copy operation, press the [8 ▼] (CANCEL) button.

**5 Select the destination tab (USER, HD or USB) to paste the file/folder, by using the TAB [◀][▶] buttons.****6 Press the [4 ▼] (PASTE) button to paste the file/folder.**

The file/folder copied and pasted appears on the display at the appropriate position among the files in alphabetical order.

## Moving Files (Cut & Paste)

This operation lets you cut a file and paste it to another location (folder).

**1 Call up the display containing the file you want to move.**

**2 Press the [2 ▼] (CUT) button to cut the file.**

The pop-up window for the Cut operation appears at the bottom of the display.



**3 Press one of the [A]–[J] buttons corresponding to the desired file.**

To cancel the selection, press the same [A]–[J] button again.

Press the [6 ▼] (ALL) button to select all files indicated on the current display including the other pages. To cancel the selection, press the [6 ▼] (ALL OFF) button again.

**4 Press the [7 ▼] (OK) button to confirm the file selection.**

To cancel the Cut operation, press the [8 ▼] (CANCEL) button.

**5 Select the destination tab (USER, HD or USB) to which the file is to be pasted, by using the TAB [◀][▶] buttons.**

**6 Press the [4 ▼] (PASTE) button to paste the file.**

The file moved and pasted appears on the display at the appropriate position among the files in alphabetical order.



### NOTE

Files in the PRESET tab cannot be cut.

## Deleting Files/Folders

This operation lets you delete a file/folder.

**1 Call up the display containing the file/folder you want to delete.**

**2 Press the [5 ▼] (DELETE) button.**

The pop-up window for the Delete operation appears at the bottom of the display.

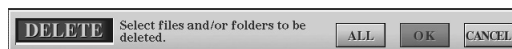

**3 Press one of the [A]–[J] buttons corresponding to the desired file/folder.**

To cancel the selection, press the same [A]–[J] button again.

Press the [6 ▼] (ALL) button to select all files/folders indicated on the current display including the other pages. To cancel the selection, press the [6 ▼] (ALL OFF) button again.

**4 Press the [7 ▼] (OK) button to confirm the file/folder selection.**

To cancel the Delete operation, press the [8 ▼] (CANCEL) button.

**5 Follow the on-display instructions.**

- YES ..... Delete the file/folder
- YES ALL ..... Delete all selected files/folders
- NO ..... Leave the file/folder as is without deleting
- CANCEL ..... Cancel the Delete operation



### NOTE

Files in the PRESET tab cannot be deleted.



## Renaming Files/Folders

This operation lets you rename files/folders.

- 1 Call up the display containing the file/folder you want to rename.

- 2 Press the [1 ▼] (NAME) button.

The pop-up window for the Rename operation appears at the bottom of the display.



- 3 Press one of the [A]–[J] buttons corresponding to the desired file/folder.

- 4 Press the [7 ▼] (OK) button to confirm the file/folder selection.

To cancel the Rename operation, press the [8 ▼] (CANCEL) button.

- 5 Input the name (characters) of the selected file or folder (page 34).

The renamed file/folder appears on the display at the appropriate position among the files in alphabetical order.

### NOTE

Files in the PRESET tab cannot be renamed.

## Creating a New Folder

This operation lets you create new folders. Folders can be created, named and organized as desired, making it easier to find and select your original data.

- 1 Call up the page of the File Selection display for which you wish to create a new folder.

- 2 Press the [7 ▼] (FOLDER) button to call up the naming display for a new folder.



- 3 Input the name of the new folder (see page 34).

### NOTE

A new folder cannot be made in the PRESET tab.

### NOTE

The maximum number of files/folders which can be stored in a folder is 500.

### NOTE

In the USER tab display, folder directories can contain up to four levels. The maximum total number of files/folders which can be stored differs depending on the file size and the length of the file/folder names.

### NOTE

The following marks cannot be entered for a file/folder name.

\\ : \* ? " < > |

## ■ Entering Characters

The instructions that follow show you how to enter characters for naming your files/folders, inputting keywords, etc. Entering characters should be done in the display shown below.

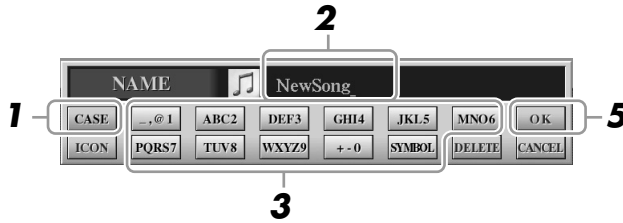

### 1 Change the type of character by pressing the [1 ▲] button.

- **CASE**..... capital letters, numbers, marks
- **case**..... lowercase letters, numbers, marks

### 2 Use the [DATA ENTRY] dial to move the cursor to the desired position.

### 3 Press the [2 ▲▼]–[6 ▲▼] and [7 ▲] buttons, corresponding to the character you wish to enter.

Several different characters are assigned to each button, and the characters change each time you press the button. To actually enter the selected character, move the cursor or press another letter-input button. Alternately, you can wait for a short time and the characters will be entered automatically.

### 4 Repeat steps 2–3 to enter the entire name.

#### ● Deleting characters

Move the cursor to the character you wish to delete by using the [DATA ENTRY] dial, and press the [7 ▼] (DELETE) button. To delete all characters on the line at once, press and hold the [7 ▼] (DELETE) button.

#### ● Entering marks or space

- 1 Press the [6 ▼] (SYMBOL) button to call up the mark list.
- 2 Use the [DATA ENTRY] dial to move the cursor to the desired mark or space, then press the [8 ▲] (OK) button.

#### ● Canceling the character-entering operation

Press the [8 ▼] (CANCEL) button.

#### Selecting custom icons for files (shown at left of file name)

You can select custom icons for files (shown at the left of file name).

- 1 Press the [1 ▼] (ICON) button to call up the ICON SELECT display.
- 2 Select the icon by using the [A]–[J] buttons, [3 ▲▼]–[5 ▲▼] buttons or [DATA ENTRY] dial.  
The ICON display includes several pages. Press the TAB [◀|▶] buttons to select different pages.  
To cancel the operation, press the [8 ▼] (CANCEL) button.
- 3 Press the [8 ▲] (OK) button to apply the selected icon.

### 5 Press the [8 ▲] (OK) button to actually enter the new name and return to the previous display.

#### NOTE

When inputting lyrics in the Song Creator function, you may also enter Japanese characters (kana and kanji).

#### NOTE

When entering a password for a website or the WEP key for wireless LAN connection, the characters are converted to asterisks (\*) for security purposes.

## Restoring the Factory-programmed Settings

While holding the C6 key (right-most key on the keyboard), turn the [POWER] button ON. This restores the all settings (except Internet Settings) to the factory default.

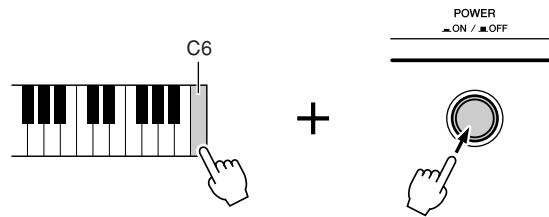

### NOTE

If you want to initialize only the Registration Memory settings, turn the [POWER] button on while holding the B5 key.

This operation does not affect the Internet Settings. To reset the Internet Settings, call up the operation display: [INTERNET] → [5 ▼] SETTING → TAB [◀▶] OTHERS (see page 87).

You can also restore a specified setting to the factory default value, or save/load your own reset settings. Call up the operation display: [FUNCTION] → [I] UTILITY → TAB [◀▶] SYSTEM RESET. For details, refer to the Reference Manual on the website.

## Data Backup

For maximum data security Yamaha recommends that you copy or save your important data to a USB storage device. This provides a convenient backup if the internal memory is damaged.

- 1** Insert/connect the backup USB storage device (destination).
- 2** Call up the operation display.  
[FUNCTION] → [I] UTILITY → TAB [◀▶] OWNER



- 3** Press the [D] (BACKUP) button to save the data to the USB storage device.

To restore the data, press the [E] (RESTORE) button in this display.

### NOTE

Completing the backup/restore operation may take a few minutes.

### CAUTION

**Move the Protected Songs which are saved to the USER display before restoring. If the songs are not moved, the operation deletes the data.**

### NOTE

To save the Song, Style, Multi Pad, Registration Memory Bank and Voice independently, execute the Copy & Paste operation from the File Selection display (page 31).

### NOTE

To save the Music Finder Record, Effect, MIDI Template and System File, call up the operation display: [FUNCTION] → [I] UTILITY → TAB [◀▶] SYSTEM RESET. For more information, refer to the Reference Manual on the website.

# Voices

## – Playing the Keyboard –

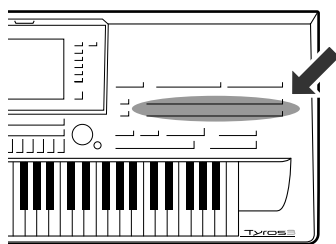

The Tyros3 features a wide variety of exceptionally realistic instrumental Voices, including piano, guitar, strings, brass, wind instruments and more. These include special MegaVoices and Super Articulation Voices. In particular, the ultra-natural Super Articulation 2 Voices provide a level of expressive capability and subtle performance nuances previously unavailable in keyboard instruments.

### Playing Preset Voices

#### Selecting a Voice (RIGHT 1) and playing the keyboard

- 1 Press the PART SELECT [RIGHT 1] button.**

Make sure that the PART ON/OFF [RIGHT1] button is also turned on. If it is turned off, the right-hand part will not sound.

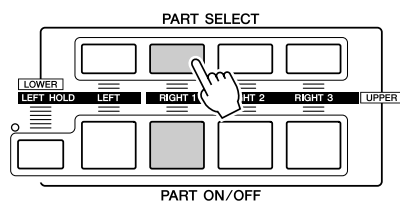

- 2 Press one of the VOICE category selection buttons to select a Voice category and call up the Voice Selection display.**

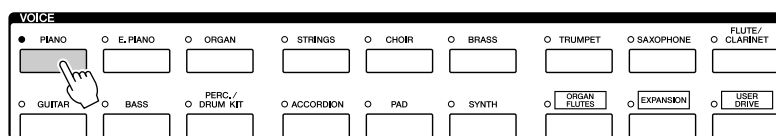

The preset Voices are categorized and contained in appropriate folders. Voice buttons on the panel correspond to the categories of the preset Voices. For example, press the [PIANO] button to display various piano Voices. For more information on the VOICE category selection buttons, refer to page 39.

### 3 Press one of the [A]–[J] buttons to select the desired Voice.

To call up the other display pages, press one of the [1 ▲]–[4 ▲] buttons or press the same VOICE button again.



#### NOTE

The Voice type and its defining characteristics are indicated above the Preset Voice name. For details on the characteristics, see page 39.

#### NOTE

You can call up the information for the selected Voice by pressing the [6 ▲] (INFO) button. To close the information display, press the [EXIT] button or [F] (OK) button.

#### To listen to the demo songs for each Voice

Press the [8 ▼] (DEMO) button to start the Demo for the selected Voice. To stop the demo, press the [8 ▼] button again.

### 4 Play the keyboard.

#### Recalling your favorite Voices easily

The Tyros3 has a huge amount of high-quality Voices, covering an exceptionally broad range of instrument sounds—making it perfect for virtually every musical application. However, the sheer number of Voices may seem overwhelming at first. By using the [USER DRIVE] button, you can easily recall your favorite Voice.

- 1 Copy your favorite Voice from the Preset drive to the User drive. Refer to page 31 for details on the copy operation.
- 2 Press the [USER DRIVE] button to call up the User drive of the Voice Selection display, then press one of the [A]–[J] buttons to select the desired Voice.

## Playing Two or Three Voices Simultaneously

1 Make sure that PART ON/OFF [RIGHT 1] button is turned on.

2 Press the PART ON/OFF [RIGHT 2] button to turn it on.

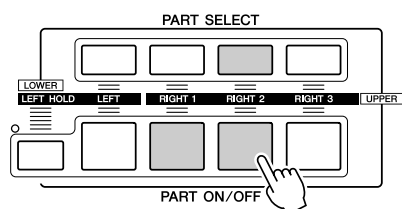

3 Press one of the VOICE category selection buttons to call up the Voice Selection display for the Right 2 part.

4 Press one of the [A]–[J] buttons to select the desired Voice.

5 Play the keyboard.

The Voice selected for RIGHT 1 (page 36) and the Voice selected here are sounded simultaneously in a layer.

Voice RIGHT 3 can be set in the same way described above, by using the [RIGHT 3] button instead.

#### NOTE

You can save the settings to Registration Memory. See page 68.

## Playing Different Voices with the Left and Right Hands

- 1 Make sure that some of PART ON/OFF [RIGHT 1]–[RIGHT 3] buttons are turned on.
- 2 Press the PART ON/OFF [LEFT] button to turn it on.

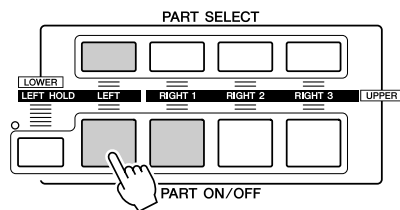

- 3 Press one of the VOICE category selection buttons to call up the Voice Selection display for the Left part.
- 4 Press one of the [A]–[J] buttons to select the desired Voice.
- 5 Play the keyboard.

The notes you play with your left hand sound one Voice (LEFT 1 Voice selected above), while the notes you play with your right sound a different Voices (RIGHT 1–3 Voices).

### NOTE

You can save the settings to Registration Memory. See page 68.

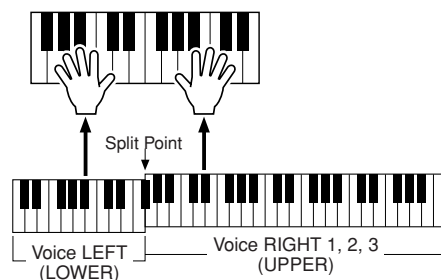

### Keyboard Parts

Voices can be assigned independently to each of the four keyboard parts: Right 1, Right 2, Right 3 and Left. You can combine these parts by using the PART ON/OFF buttons to create a rich, ensemble sound.

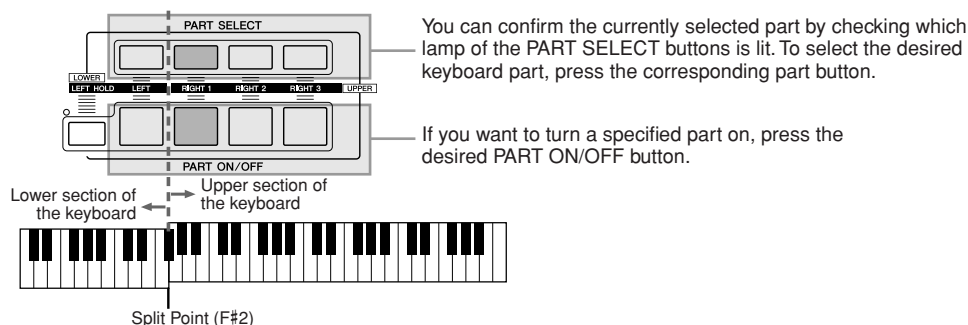

When the LEFT part is off, the RIGHT 1–3 Voices can be played over the entire keyboard. When the LEFT part is on, keys lower than F#2 (the Split Point) are set for playing the LEFT part and those higher than the Split Point are set for playing the RIGHT 1–3 parts.

### NOTE

To change the Split Point, press: [FUNCTION] → [C] STYLE SETTING/SPLIT POINT/CHORD FINGERING → TAB [◀▶] SPLIT POINT. For more information, refer to the Reference Manual on the website.

### Holding the LEFT part Voice (Left Hold)

This function causes the LEFT part Voice to be held even when the keys are released. Non-decaying Voices such as strings are held continuously, while decay-type Voices such as piano decay more slowly (as if the sustain pedal has been pressed).

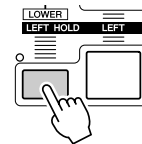

## Voice Types

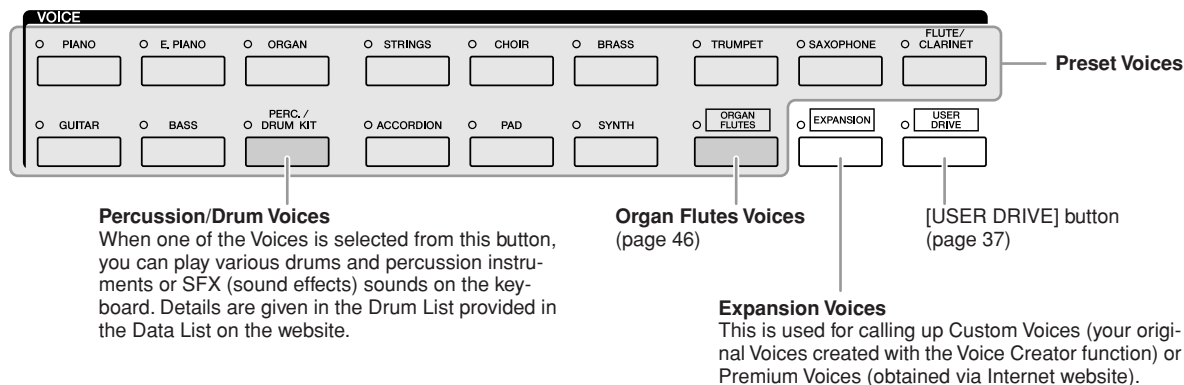

### ■ Voice Characteristics

The Voice type and its defining characteristics are indicated above the Voice name—Live!, Cool!, Sweet!, etc.. For detailed explanation, refer to the Reference Manual. In this section, only Mega Voice and Super Articulation Voices (SA and SA2) are explained. These Voices have special characteristics you should be aware of, and they require specific performance techniques to bring out all of their expressive qualities.

#### ● MegaVoices

What makes MegaVoices special is their use of velocity switching. Each velocity range (the measure of your playing strength) has a completely different sound. For example, a guitar MegaVoice includes the sounds of various performance techniques. In conventional instruments, different Voices having those sounds would be called up via MIDI and played in combination to achieve the desired effect. However, now with MegaVoices, a convincing guitar part can be played with just a single Voice, using specific velocity values to play the desired sounds. Because of the complex nature of these Voices and the precise velocities need to play the sounds, they're not intended for playing from the keyboard. They are, however, very useful and convenient when creating MIDI data—especially when you want to avoid using several different Voices just for a single instrument part.

#### NOTE

MegaVoices, SA and SA2 Voices are only compatible with other models which have those three types of Voices installed. Any Song, Style or Multi Pads data you've created on the Tyros3 using these Voices will not sound properly when played back on other instruments.

#### NOTE

MegaVoices, SA and SA2 Voices sound differently depending on the keyboard range, velocity, touch, etc. Hence, if you apply HARMONY/ECHO effect, change the transpose setting or change the Voice Set parameters, unexpected or undesired sounds may result.

## ● Super Articulation Voices

The word “articulation” in music usually refers to the transition or continuity between notes. This is often reflected in specific performance techniques, such as staccato, legato and slur. Two types of Voices—Super Articulation (SA) Voices and Super Articulation 2 (SA2) Voices—enable you to create these subtle musical expressions, simply by how you play.

### SA Voices (S.Articulation!)

The SA Voices provide many of same benefits as the MegaVoices, but with greater playability and expressive control in real time.

For example, with the Saxophone Voice, if you play a C and then a D in a very legato way, you will hear the note change seamlessly, as though a saxophone player played it in a single breath. Similarly with the Concert Guitar Voice, the D note would sound as a “hammer on”, without the string being plucked again.

Depending on how you play, other effects such as shake or breath noises (for the Trumpet Voice), or finger noises (for the Guitar Voice) will be produced.

### SA2 Voices (S. Articulation2!)

Mainly for wind instrument Voices, a special Yamaha technology called AEM has been used, which features detailed samples of special expressive techniques used on those specific instruments—to bend or slide into notes, to “join” different notes together, or to add expressive nuances at the end of a note, etc.

You can add these articulations by playing legato or staccato, or by jumping in pitch by around an octave. For example, using the Clarinet Voice, if you hold a C note and play the B $\flat$  above, you’ll hear a glissando up to the B $\flat$ . Some “note off” effects are also produced automatically when you hold a note for over a certain time.

Each SA2 Voice has its own default vibrato setting, so that when you select a SA2 Voice, the appropriate vibrato is applied regardless of the Modulation wheel position. You can adjust the vibrato by moving the Modulation wheel.

You can also use the [ART. 1]/[ART. 2] buttons to add articulations to the SA and SA2 Voices (page 42).

For details on how to best play each SA and SA2 Voice, call up the information window (pressing the [6 ▲] (INFO) button in the Voice Selection display.)

#### NOTE

For more information on AEM technology, see below.

#### NOTE

The characteristics of SA2 Voices (default vibrato setting and articulation effects applied by the [ART] buttons) are effective for real-time performance; however, these effects may not be completely reproduced when you play back a Song which has been recorded using SA2 Voices.

### AEM Technology

When you play the piano, pressing a “C” key produces a definite and relatively fixed C note. When you play a wind instrument, however, a single fingering may produce several different sounds depending on the breath strength, the note length, the adding of trills or bend effects, and other performance techniques. Also, when playing two notes continuously—for example “C” and “D”—these two notes will be smoothly joined, and not sound independent as they would on a piano.

AEM (Articulation Element Modeling) is the technology for simulating this characteristic of instruments. During performance, the most appropriate sound samples are selected in sequence in real time, from huge quantities of sampled data. They are smoothly joined and sounded—as would naturally occur on an actual acoustic instrument.

This technology to smoothly join different samples enables the application of realistic vibrato. Conventionally on electronic musical instruments, vibrato is applied by moving the pitch periodically. AEM technology goes much further by analyzing and disaggregating the sampled vibrato waves, and smoothly joins the disaggregated data in real time during your performance. If you move the Modulation wheel when you play the SA2 Voice (using AEM technology), you can also control the depth of the vibrato, while maintaining its realistic quality.



## Transposing the Pitch of the Keyboard

The TRANSPOSE [-]/[+] buttons transpose the overall pitch of the instrument (the keyboard sound, Style playback, Song playback, and so on) in semitone steps. Press the [+] and [-] buttons simultaneously to instantly reset the transpose value to 0.

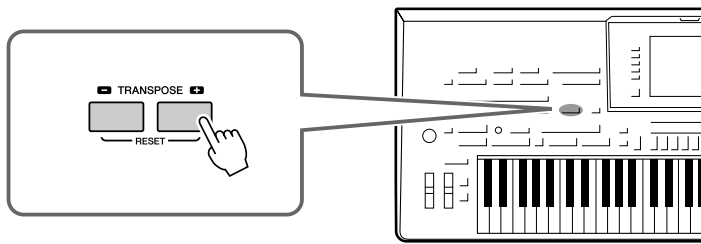

### NOTE

The Transpose functions do not affect the Drum Kit or SFX Kit Voices.

### NOTE

You can also change the transpose settings in the MIXING CONSOLE display: [MIXING CONSOLE] → TAB [◀|▶] TUNE → [1 ▲▼]–[3 ▲▼] TRANSPOSE.

The UPPER OCTAVE [-]/[+] buttons allow the pitch of the RIGHT 1–3 parts to be shifted up or down by one octave. Press the [+] and [-] buttons simultaneously to instantly reset the octave value to 0.

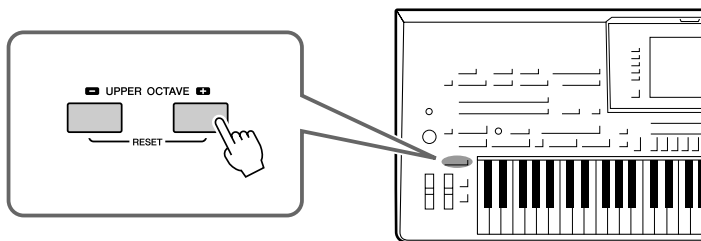

## Using the Wheels

### Using the Pitch Bend Wheel

Use the PITCH BEND wheel to bend notes up (roll the wheel away from you) or down (roll the wheel toward you) while playing the keyboard. The Pitch Bend is applied to all the keyboard parts (RIGHT 1–3 and LEFT). The PITCH BEND wheel is self-centering and will automatically return to normal pitch when released.

### NOTE

The effects caused by using the PITCH BEND Wheel may not be applied to the LEFT part during Style playback depending on the Style setting.

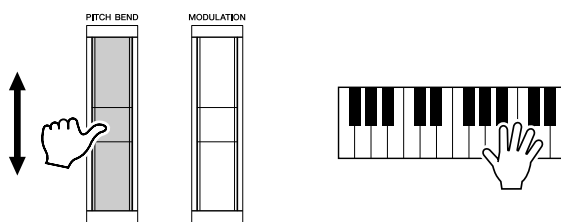

The maximum pitch bend range can be changed on the Mixing Console display: [MIXING CONSOLE] → TAB [◀|▶] TUNE → [H] PITCH BEND RANGE.

## Using the Modulation Wheel

The Modulation function applies a vibrato effect to notes played on the keyboard. By default, this is applied to the keyboard parts RIGHT 1–3. Moving the MODULATION wheel down (toward you) decreases the depth of the effect, while moving it up (away from you) increases it.

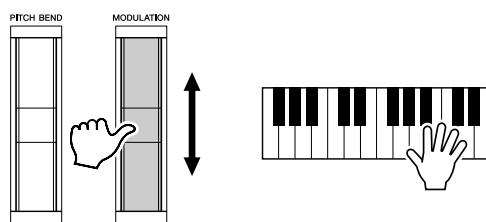

You can set whether the effects caused by the MODULATION Wheel will be applied or not to each of the keyboard part: [FUNCTION] → [D] CONTROLLER → TAB [◀][▶] KEYBOARD/PANEL → [A]/[B] 3 MODULATION WHEEL

### NOTE

Depending on the selected Voice, the MODULATION wheel may control volume, filter or some other parameter instead of vibrato.

### NOTE

To avoid accidentally applying modulation, make sure the MODULATION Wheel is set at minimum (down) position before you start playing.

### NOTE

The effects caused by using the MODULATION wheel may not be applied to the LEFT part during Style playback depending on the Style setting.

## Adding Articulation Effects to Super Articulation Voices

With the [ART. 1]/[ART. 2] buttons, you can add articulation effects and characteristic instrument performance sounds to your playing. When you select a SA or SA2 Voice, the [ART. 1] and/or [ART. 2] buttons may light in green. Pressing a lit button adds articulation. (Pressing a button which is not lit has no effect.)

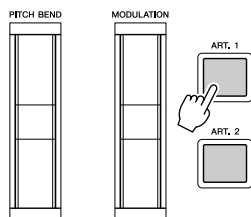

### NOTE

The applied articulation effect differs depending on the selected Voice. For details, refer to the Information display called up by pressing the [6 ▲] (INFO) button on the Voice Selection display.

Depending on the selected Voice, there are three types of effects.

### ● Type 1

With this type, you can use the available [ART] button to trigger different playing effects, separate from your keyboard playing. For example, in the case of the SA Saxophone Voice, pressing the [ART. 1] button produces the sound of a sax player taking a breath, and pressing the [ART. 2] button produces the noise of the saxophone's keys. (You can effectively intersperse these into the notes as you play.) In the case of the SA JazzClean Voice in GUITAR category, the [ART. 1] button produces a body tapping sound and the [ART. 2] button produces some fret noise.

While the articulation effect sounds, the button lights in red.

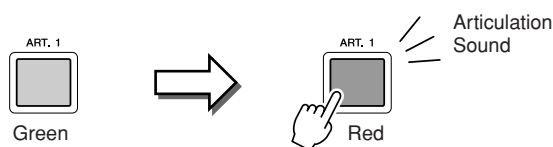

## ● Type 2

In this type, playing the keyboard while holding down the available [ART] button changes the nature of Voice. For example, in the case of the SA Nylon Guitar Voice, holding down the [ART. 1] button lets you play harmonics for the guitar Voice. Releasing the button returns the Voice to normal. In the case of SA BigBandBrass Voice, normally there is a pitch “shake” when you play at a higher velocity, but if you hold the [ART. 1] button while you play, the shake will be replaced by a fall.

The button lights in red while it is being held down.

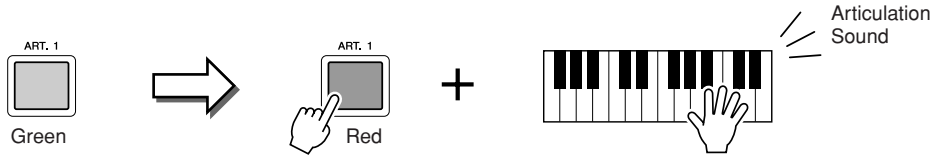

## ● Type 3

With this type, pressing the available [ART] button alters the attack and release of the note. Each [ART] button has two different effects, depending on whether you press it before you play a note, or while you are holding a note.

For example, in the case of SA2 Jazz Trumpet, pressing the [ART. 1] button before you play a note produces a bend up to the note you first play. Pressing it while you are holding a note will produce a bend down as you release the note. Pressing the [ART. 2] button before playing a note will produce a long glissando up to the note you are playing, and pressing it while holding a note will produce a fall when you release the note.

When you press the available [ART] button, it will flash in red until the effect is finished playing. You can cancel by pressing the button again while it flashes. Just after you press/release the note and articulation effect sounds, the button lights in red.

### NOTE

Keeping with the realistic response of the original instruments, the effects applied vary depending on the range you are playing in.

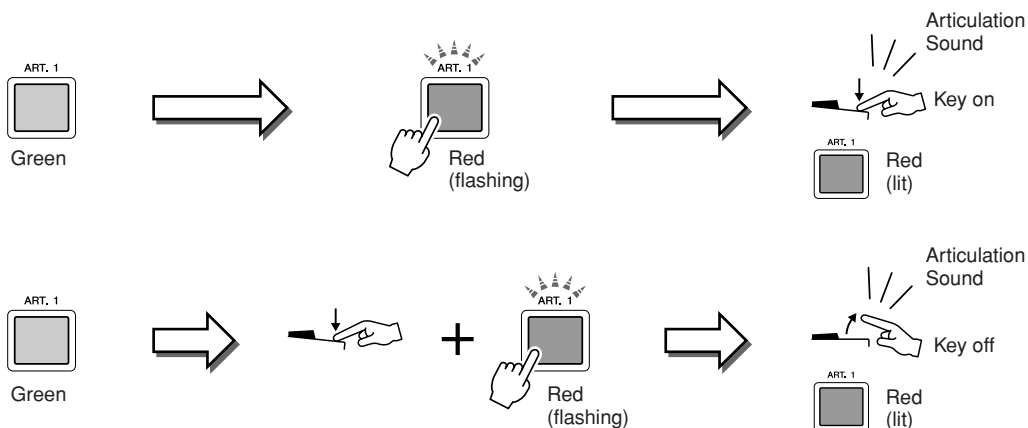

Type 3 effects can also be used in the same manner as Type 2. Holding an [ART] button (the button flashes in red) and playing/releasing a note enables you to add the articulation effect several times in succession.

### **Notice for when Super Articulation Voices are selected for multiple parts**

When you select SA/SA2 Voices for two or more keyboard parts, using an [ART] button simultaneously affects all parts on which SA/SA2 Voices are selected.

When a Type 3 effect is assigned to both the Right and Left parts and an [ART] button flashes in red (standby status), playing only one part (for example Right part) adds an articulation effect to only the Right part. Since the other part (Left part) is kept in standby status, the button continues flashing. To cancel the standby status, you need to play the keyboard in the Left part range. (Pressing the flashing button cannot cancel standby status, because this can cancel the standby of the Left part but turns the Right part to standby again.)

## Applying Voice Effects

The Tyros3 features a sophisticated multi-processor effect system which can add extraordinary depth and expression to your sound. This effect system can be turned on or off by using the following buttons.

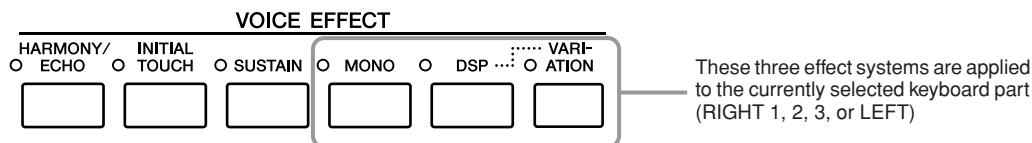

### ● HARMONY/ECHO

The Harmony/Echo types are applied to the right-hand Voices. Refer to “Applying Harmony to Your Right-hand Melody” on page 45.

### ● INITIAL TOUCH

This button turns the touch response of the keyboard on or off. When OFF, the same volume is produced no matter how strongly or softly you play the keyboard.

### ● SUSTAIN

When this Sustain function is on, all notes played on the keyboard with right-hand part (RIGHT 1, 2, 3) have a longer sustain.

### ● MONO

When this button is on, the part’s Voice is played monophonically (only one note at a time). Using the MONO mode lets you play single, lead sounds (such as brass instruments) more realistically. It also lets you expressively control the Portamento effect (depending on the selected Voice) by playing legato.

When this button is off, the part’s Voice played polyphonically.

### ● DSP/DSP VARIATION

With the digital effects built into the instrument, you can add ambience and depth to your music in a variety of ways—such as adding reverb that makes you sound like you are playing in a concert hall.

The [DSP] button is used to turn the DSP (Digital Signal Processor) effect on or off for the currently selected keyboard part.

The [VARIATION] button is used to change between variations of the DSP effect. You could use this while you play, for example, to change the rotating speed (slow/fast) of the rotary speaker effect.

#### NOTE

Portamento is a function that creates a smooth transition in pitch from the first note played on the keyboard to the next.

#### NOTE

The effect type can be changed. On the Voice Selection display, select [5 ▲] (VOICE SET) → TAB [◀▶] EFFECT/EQ → [A]/[B] 2 DSP.

## Applying Harmony to Your Right-hand Melody (HARMONY/ECHO)

Among the Voice Effects, Harmony is one of the most impressive. It automatically adds harmony parts to the notes you play with your right hand—immediately giving you a more full and professional sound.

### 1 Turn the [HARMONY/ECHO] button on.

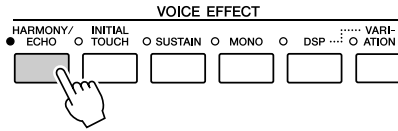

### 2 Turn on both the [ACMP] button and [SYNC START] button (page 48) and make sure that the RIGHT 1 part is on (page 36).

### 3 Play a chord with your left hand to start the Style (page 49) and play some notes in the right-hand range of the keyboard.

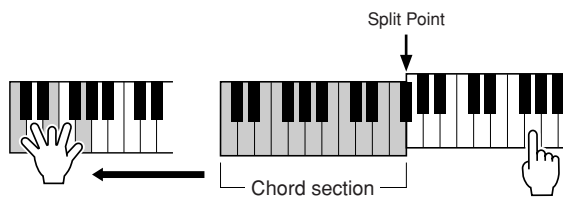

In this example, harmony notes in the scale of C major (the chord played in the left hand) are automatically added to the notes played in the right-hand range of the keyboard.

You can also use the Harmony effect with the Style stopped. Simply hold down a chord with your left hand and play a melody with your right.

Many of the Voices have been automatically set to play certain Harmony/Echo types that match the particular Voice. Try out some of Voices. You can also change the Harmony/Echo type: [FUNCTION] → [F] HARMONY/ECHO.

# Creating Your Original Organ Flutes Voices

The Tyros3 uses advanced digital technology to recreate the legendary sound of vintage organs. Just as on a traditional organ, you can create your own sound by increasing and decreasing the levels of the flute footages.

## 1 Press the [ORGAN FLUTES] button.

The FOOTAGE Page of the Organ Flutes Voice is called up.

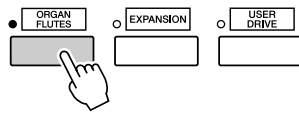

## 2 Use the [ASSIGN] slider and [1]–[8] sliders to adjust the footage settings.

The footage settings determine the basic sound of the organ flutes. The term “footage” is a reference to the sound generation of traditional pipe organs, in which the sound is produced by pipes of different lengths (in feet).

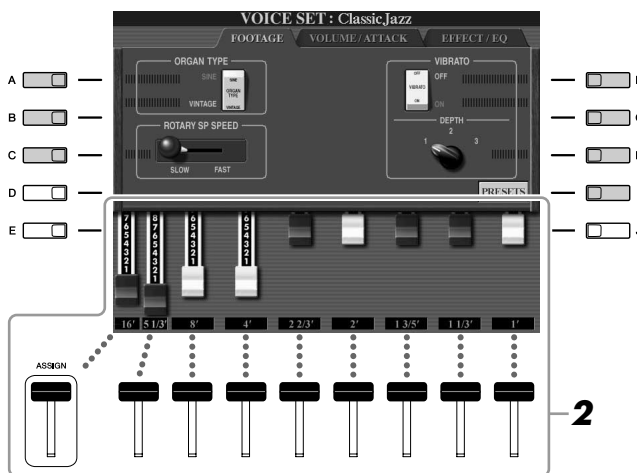

### NOTE

You can also use the [1 ▲▼]–[8 ▲▼] buttons to adjust the footages 5 1/3'–1'.

### NOTE

When this display is shown, the function assigned to the ASSIGN controller does not work. The ASSIGN slider works only to adjust the 16' footage.

If you want, you can select the Organ type, change the Rotary Speaker speed and adjust the Vibrato setting, by using the [A]–[C] and [F]–[H] buttons.

### NOTE

About the VOLUME/ATTACK Page and EFFECT/EQ Page, see the Reference Manual on the website.

[A]/[B]	ORGAN TYPE	Specifies the type of organ tone generation to be simulated: Sine or Vintage.
[C]	ROTARY SP SPEED	Alternately switches between the slow and fast rotary speaker speeds when a rotary speaker effect is selected for the Organ Flutes (DSP TYPE parameter in the EFFECT/EQ Page), and the VOICE EFFECT [DSP] button is turned on.
[F]	VIBRATO OFF	Alternately turns the vibrato effect for the Organ Flutes Voice ON or OFF.
[G]	VIBRATO ON	
[H]	VIBRATO DEPTH	Sets the Vibrato depth to one of three levels: 1 (low), 2 (mid), or 3 (high).
[I]	PRESETS	Opens the File Selection display of the Organ Flute Voices for selecting a preset Organ Flutes Voice.

## 3 Press the [I] (PRESETS) button to return to the Organ Flutes Voice Selection display.

## 4 Use the TAB [◀][▶] buttons to select the location to which your Organ Flutes Voice will be saved.

## 5 Press the [6 ▼] (SAVE) button to save your edited Organ Flutes Voice (page 30).

### CAUTION

The settings will be lost if you select another Voice or turn the power to the instrument off without executing the Save operation.

Advanced Features	Refer to the Reference Manual on the website.
Selecting GM/XG or other Voices from the Panel	Voice Selection display → [8 ▲] (UP) → [2 ▲] (P2)
<b>Effect-related settings</b>	
<ul style="list-style-type: none"> <li>Setting the touch sensitivity of the keyboard:</li> </ul>	[FUNCTION] → [D] CONTROLLER → TAB [◀▶] KEYBOARD/PANEL
<ul style="list-style-type: none"> <li>Selecting the Harmony/Echo type:</li> </ul>	[FUNCTION] → [F] HARMONY/ECHO
<b>Pitch-related settings</b>	
<ul style="list-style-type: none"> <li>Fine-tuning the pitch of the entire instrument</li> </ul>	[FUNCTION] → [A] MASTER TUNE/SCALE TUNE → TAB [◀▶] MASTER TUNE
<ul style="list-style-type: none"> <li>Scale Tuning:</li> </ul>	[FUNCTION] → [A] MASTER TUNE/SCALE TUNE → TAB [◀▶] SCALE TUNE
<ul style="list-style-type: none"> <li>Changing the part assignment of the TRANSPOSE buttons:</li> </ul>	[FUNCTION] → [D] CONTROLLER → TAB [◀▶] KEYBOARD/PANEL → [A]/[B] 4 TRANSPOSE ASSIGN
<b>Editing Voices (Voice Set):</b>	
<ul style="list-style-type: none"> <li>Disabling automatic selection of Voice Sets (effects, etc.):</li> </ul>	Voice Selection display → [5 ▲] (VOICE SET) [FUNCTION] → [E] REGIST SEQUENCE/FREEZE/VOICE SET → TAB [◀▶] VOICE SET
Editing Organ Flutes parameters:	[ORGAN FLUTES] → TAB [◀▶] VOLUME/ATTACK or EFFECT/EQ
<b>Creating Custom Voices (Voice Creator)</b>	
<ul style="list-style-type: none"> <li>Creating Normal Voices:</li> </ul>	[VOICE CREATOR] → (Select a Normal Voice) → [G] WAVE IMPORT
<ul style="list-style-type: none"> <li>Creating Drum Voices:</li> </ul>	[VOICE CREATOR] → (Select a Drum Voice) → [G] WAVE IMPORT
<ul style="list-style-type: none"> <li>Editing an Expansion Voice Bank:</li> </ul>	[VOICE CREATOR] → [B] LIBRARY EDIT
<ul style="list-style-type: none"> <li>Saving your Custom Voice to a Library:</li> </ul>	[VOICE CREATOR] → [C] LIBRARY SAVE
<ul style="list-style-type: none"> <li>Loading a single Additional Voice to the Tyros3:</li> </ul>	[VOICE CREATOR] → [D] INDIVIDUAL LOAD
<ul style="list-style-type: none"> <li>Loading an Expansion Voice Bank (Library) to the Tyros3:</li> </ul>	[VOICE CREATOR] → [A] LIBRARY LOAD
<ul style="list-style-type: none"> <li>Editing a Custom Voice on your computer:</li> </ul>	[VOICE CREATOR] → [F] CUSTOM VOICE EDIT via PC

# Styles

## – Playing Rhythm and Accompaniment –

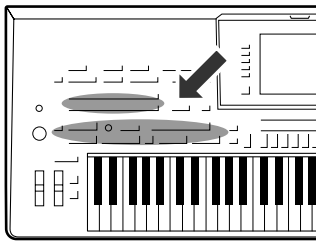

The Tyros3 features a variety of accompaniment and rhythmic backing patterns (called “Styles”) in a variety of different musical genres including pop, jazz, and many others. The Style features Auto Accompaniment, letting you produce automatic accompaniment playback simply by playing “chords” with your left hand. This lets you automatically recreate the sound of a full band or orchestra—even if you’re playing by yourself.

2

Styles – Playing Rhythm and Accompaniment –

### Playing a Style with the Auto Accompaniment

- 1 Press one of the STYLE category selection buttons to call up the Style Selection display.

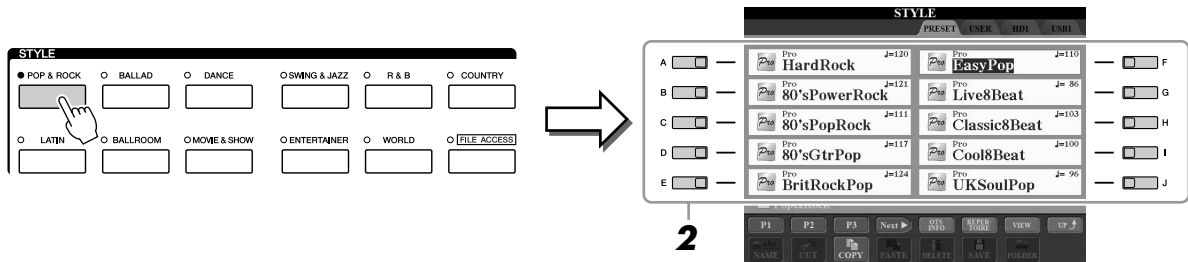

- 2 Press one of the [A]–[J] buttons to select the desired Style.

Pressing one of the [1 ▲]–[4 ▲] buttons or pressing the same STYLE button again can call up the other display page.

- 3 Press the [ACMP] button to turn on the Auto Accompaniment.

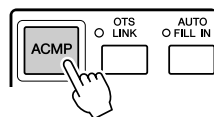

The specific left-hand section of the keyboard (page 38) becomes the Chord section, and chords played in this section are automatically detected and used as a basis for fully automatic accompaniment with the selected Style.

- 4 Press the [SYNC START] button to enable synchronized start.

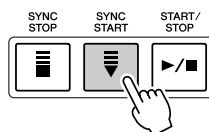



## 5 As soon as you play a chord with your left hand, the selected Style starts.

Try playing chords with your left hand and play melody with your right hand.

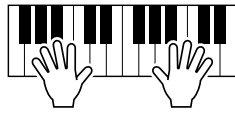

### NOTE

If you want to know which key you need to play to make certain chords, call up the CHORD FINGERING display:  
[FUNCTION] → [C] STYLE SETTING/  
SPLIT POINT/CHORD FINGERING →  
TAB [◀▶] CHORD FINGERING.  
For more information, refer to the Reference Manual on the website.

## 6 Press the [START/STOP] button to stop Style playback.

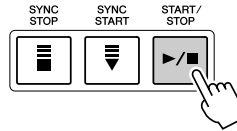

### Style Characteristics

The Style type and its defining characteristics are indicated on the Preset Style icon.



- **Pro:** These Styles provide professional and exciting arrangements combined with perfect playability. The resulting accompaniment exactly follows the chords of the player. As a result, your chord changes and colorful harmonies are instantly transformed into lifelike musical accompaniment.
- **Session:** These Styles provide even greater realism and authentic backing by mixing in original chord types and changes, as well as special riffs with chord changes, with the Main sections. These have been programmed to add “spice” and a professional touch to your performances of certain songs and in certain genres. Keep in mind, however, that the Styles may not necessarily be appropriate—or even harmonically correct—for all songs and for all chord playing. In some cases for example, playing a simple major triad for a country song may result in a “jazzy” seventh chord, or playing an on-bass chord may result in inappropriate or unexpected accompaniment.

### Style file compatibility

The Tyros3 uses the SFF GE file format (page 7). The Tyros3 can play back existing SFF files, but they will be saved in the SFF GE format when the file is saved (or pasted) in the Tyros3. Please keep in mind that the saved file can only be played back on instruments that are compatible with the SFF GE format.

# Operating Style Playback

## To Start/Stop Playing

### ● [START/STOP] button

Style starts playing back as soon as the [START/STOP] button is pressed. To stop playback, press the button again.



### ● [SYNC START] button

This puts the Style playback in “standby.” The Style starts playing back when you press any note on the keyboard (when [ACMP] is off) or you play a chord with your left hand (when [ACMP] is on). When you start the Style playback with the [SYNC START] button, pressing this button again stops playback and puts the playback in “standby” again.

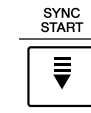

### ● [SYNC STOP] button

You can start and stop the Style anytime you want by simply playing or releasing the keys in the chord section of the keyboard. Make sure that the [ACMP] button is on, press the [SYNC STOP] button, then play the keyboard.

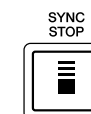

### ● INTRO [I]–[III] buttons

The Tyros3 features three different Intro sections to add an introduction before starting the Style playback. After pressing one of the INTRO [I]–[III] buttons, start playback by using the [START/STOP] button or [SYNC START] button. When the Intro finishes playing, the Style playback automatically shifts to the Main section.

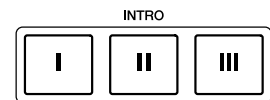

### ● ENDING/rit. [I]–[III] buttons

The Tyros3 features three different Ending sections to add an ending before stopping Style playback. When you press one of the Ending [I]–[III] buttons while Style is playing back, the Style will automatically stop after the ending is played. You can have the ending gradually slow down (ritardando) by pressing the same ENDING button once again, while the ending is playing.

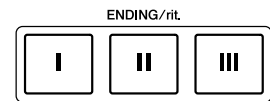

#### About the lamp status of the section buttons (INTRO/MAIN VARIATION/BREAK/ENDING)

- **Red:** The section is currently selected.
- **Red (flashing):** The section will be played next, following the currently selected section.
- **Green:** The section contains data but not currently selected.
- **Off:** The section contains no data and cannot be played.

#### NOTE

If you press the ENDING/rit. [I] button when the Style is playing, a fill-in automatically plays before the ENDING/rit [I].

## Changing Pattern Variation (Sections) During Style playback

Each Style features four different Main sections, four Fill-in sections and a Break section. By using these sections effectively, you can easily make your performance sound more dynamic and professional. The section can be freely changed while the Style is playing back.

### ● MAIN VARIATION [A]–[D] buttons

Press one of the MAIN VARIATION [A]–[D] buttons to select the desired Main section (the button lights in red). Each is an accompaniment pattern of a few measures and it plays indefinitely. Pressing the selected MAIN VARIATION button again plays an appropriate fill-in pattern to spice up the rhythm and break the repetition. After the fill-in finishes playing, it leads smoothly into the Main section.

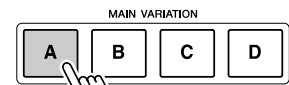

Selected Main section's lamp is lit in red

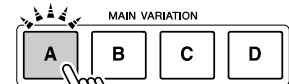

Selected Fill In section's lamp flashes in red

### AUTO FILL function

When the [AUTO FILL IN] button is turned on, pressing any of the Main [A]–[D] buttons as you play automatically plays fill-in section.



### ● [BREAK] button

This lets you add dynamic breaks in the rhythm of the accompaniment. Press the [BREAK] button during Style playback. When the one-measure Break pattern finishes playing, the Style playback automatically shifts to the Main section.

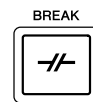

## Adjusting the Tempo

### ● [TEMPO] button

By pressing the TEMPO [-] or [+] button, you can decrease/increase the tempo over a range of 5–500. While the TEMPO pop-up is shown on the display, you can also use the [DATA ENTRY] dial to adjust the value.

#### NOTE

This operation is common for Song playback (page 59).



Pressing the TEMPO [-]/[+] buttons simultaneously resets the tempo to the default value (programmed for each Style).

### ● [TAP TEMPO] button

During Style playback, you can change the tempo by tapping the [TAP TEMPO] button twice at the desired tempo.

When the Style is stopped, tapping the [TAP TEMPO] button (four times for a 4/4 time signature) starts Style playback at the tempo you tapped.



## Fading In/Out

### ● [FADE IN/OUT] button

This produces smooth fade-ins and fade-outs when starting/stopping playback. Press the [FADE IN/OUT] button when playback is stopped and press the [START/STOP] button to start playback with a fade in. To stop the playback with a fade out, press the [FADE IN/OUT] button during playback.

#### NOTE

This operation is common for Song playback (page 59).



## Calling up the Panel Settings to Match the Style (Repertoire)

The convenient Repertoire function automatically calls up the most appropriate panel settings (Voice number, etc.) for the currently selected Style.

- 1 Select the desired Style from the “PRESET” or “USER” tab on Style Selection display (steps 1–2 on page 48).
- 2 Press the [6 ▲] (REPERTOIRE) button.  
Various appropriate panel settings matching the selected Style will be shown in the display.

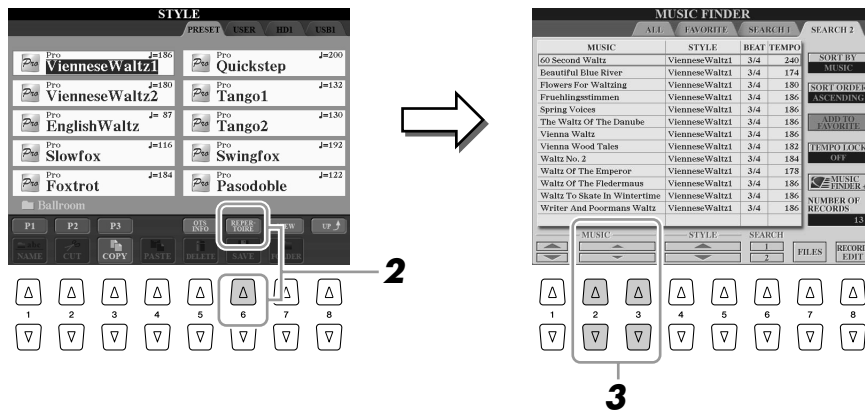

- 3 Use the [2 ▲▼]–[3 ▲▼] buttons to select the desired panel setting.

### **NOTE**

The settings shown here are Music Finder Records. You can choose additional settings by using the Music Finder feature (page 66).

## Appropriate Panel Settings for the Selected Style (One Touch Setting)

One Touch Setting is a powerful and convenient feature that automatically calls up the most appropriate panel settings (Voices or effects, etc.) for the currently selected Style, with the touch of a single button. If you've already decided which Style you wish to use, you can have One Touch Setting automatically select the appropriate Voice for you.

- 1 Select a Style (steps 1–2 on page 48).**
- 2 Press one of the ONE TOUCH SETTING [1]–[4] buttons.**

Not only does this instantly call up all the settings (Voices, effects, etc.) that match the current Style, it also automatically turns on ACMP and SYNC START, so that you can immediately start playing the Style.

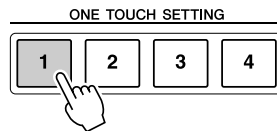

- 3 As soon as you play a chord with your left hand, the selected Style starts.**

Each Style has four One Touch Setting setups. Press other ONE TOUCH SETTING [1]–[4] button to try out other setups.

### NOTE

You can also create your own One Touch Setting setups. For details, refer to the Reference Manual on the website.

### Automatically changing One Touch Settings with the Main sections

The convenient OTS (One Touch Setting) Link function lets you automatically have One Touch Settings change when you select a different Main section (A–D). The Main sections A, B, C and D correspond to One Touch Settings 1, 2, 3 and 4 respectively. To use the OTS Link function, turn the [OTS LINK] button on.

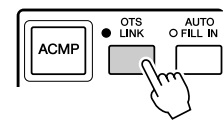

## Confirming the One Touch Setting contents

You can check the information of the One Touch Setting [1]–[4] assigned to currently selected Style.

- 1 In the Style Selection display, press the [5 ▲] (OTS INFO) button to call up the Information display.**

### NOTE

You can also call up the Information display by pressing the [DIRECT ACCESS] button then pressing one of the ONE TOUCH SETTING [1]–[4] buttons.

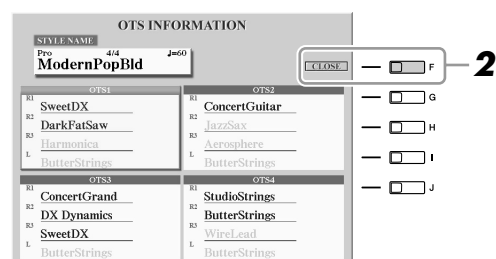

- 2 Press the [F] (CLOSE) button to close the Information display.**

## Turning Style Parts On/Off and Changing Voices

A Style contains eight channels: RHY1 (Rhythm 1)–PHR2 (Phrase 2) below. You can add variations and change the feeling of a Style by selectively turning channels on/off as the Style plays.

### ● Style channels

- **RHY1/2 (Rhythm 1/2)** .. These are the basic parts of the Style, containing the drum and percussion rhythm patterns.
- **BASS** ..... The bass part uses various appropriate instrument sounds to match the Style.
- **CHD1/2 (Chord 1/ 2)**... These are the rhythmic chord backing, commonly used with piano or guitar Voices.
- **PAD**..... This part is used for sustained instruments such as strings, organ, choir, etc.
- **PHR1/2 (Phrase1/2)** ..... These parts are used for punchy brass stabs, arpeggiated chords, and other extras that make the accompaniment more interesting.

- 1** Press the [CHANNEL ON/OFF] button once or twice to call up the CHANNEL ON/OFF (STYLE) display.

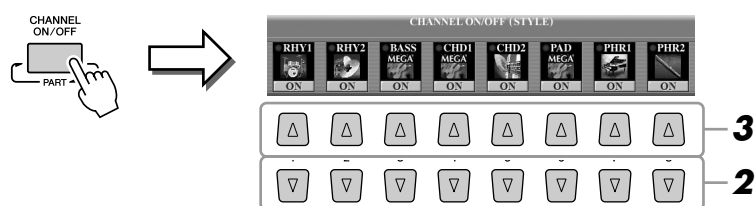

- 2** Press the [1 ▼]–[8 ▼] buttons to turn the channels on or off.

To listen to only one channel by itself, hold down the appropriate button for the channel to set the channel to SOLO. To cancel SOLO, simply press the appropriate channel button again.

- 3** If necessary, press the [1 ▲]–[8 ▲] buttons to change the Voice for the corresponding channel.

The Voice Selection display is called up from which you can select the Voice to be used for the channel. See page 27.

- 4** Press the [EXIT] button to close the CHANNEL ON/OFF display.

#### NOTE

You can save the settings here to Registration Memory. See page 68.

#### NOTE

When the Main display is shown, the CHANNEL ON/OFF display cannot be closed.

## Adjusting the Volume Balance Between the Style and Keyboard

You can adjust the volume balance between Style playback and the sound you play on the keyboard.

- 1 Press the [BALANCE] button to call up the BALANCE (1/2) display.

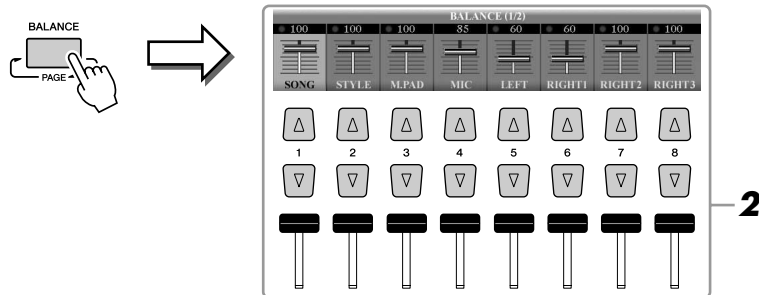

- 2 Adjust the Style volume by using the [2 ▲▼] slider or buttons.

Using the [1 ▲▼]–[8 ▲▼] sliders or buttons, you can adjust the volume of Song, Style, Multi Pad, MIC and keyboard parts.

- 3 Press the [EXIT] button to close the BALANCE display.

### NOTE

When the Main display is shown, the BALANCE display cannot be closed.

#### About the BALANCE display

Pressing the [BALANCE] button again calls up the BALANCE (2/2) display. In this display, you can also adjust the volume of Hard Disk Recorder (by [5] slider or buttons) and overall keyboard parts (by [8] slider or buttons).

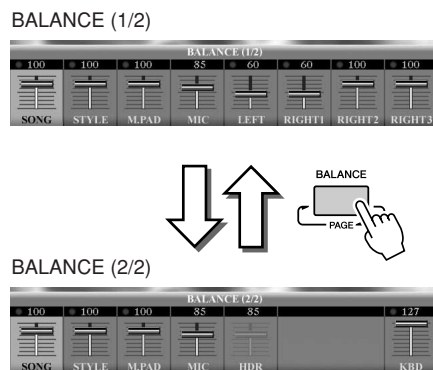

## Advanced Features

Refer to the Reference Manual on the website.

Selecting the Chord Fingering type:

[FUNCTION] → [C] STYLE SETTING/SPLIT POINT/CHORD FINGERING → TAB [◀▶] CHORD FINGERING

Style playback related settings:

[FUNCTION] → [C] STYLE SETTING/SPLIT POINT/CHORD FINGERING → TAB [◀▶] STYLE SETTING

Split Point settings:

[FUNCTION] → [C] STYLE SETTING/SPLIT POINT/CHORD FINGERING → TAB [◀▶] SPLIT POINT

Memorizing the Original One Touch Setting:

[MEMORY] + ONE TOUCH SETTING [1]–[4]

Creating/Editing Styles (Style Creator)

- Realtime Recording: [DIGITAL RECORDING] → [B] STYLE CREATOR → TAB [◀▶] BASIC
- Step Recording: [DIGITAL RECORDING] → [B] STYLE CREATOR → TAB [◀▶] EDIT → [G] STEP REC
- Style Assembly: [DIGITAL RECORDING] → [B] STYLE CREATOR → TAB [◀▶] ASSEMBLY
- Editing the Rhythmic Feel: [DIGITAL RECORDING] → [B] STYLE CREATOR → TAB [◀▶] GROOVE
- Editing Data for Each Channel: [DIGITAL RECORDING] → [B] STYLE CREATOR → TAB [◀▶] CHANNEL
- Making Style File Format Settings: [DIGITAL RECORDING] → [B] STYLE CREATOR → TAB [◀▶] PARAMETER



# Songs

## – Recording Your Performances and Creating Songs –

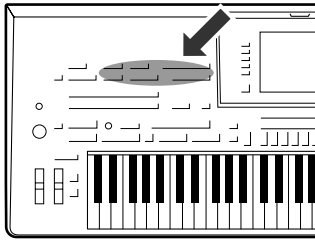

The Tyros3 not only lets you play back commercially available MIDI songs, but also allows you to create your original songs by recording your performance. The recorded performance is made up of 16 parts (channels)—Keyboard parts, Multi Pad parts and Style Playback parts as shown below—and saved as a MIDI song. This chapter explains how to quickly and easily record your performance as a MIDI song, and shows you how to play back MIDI songs on the instrument.

MIDI Channel Assignments (for Quick Recording)

Keyboard Parts				Multi Pad Parts				Style Parts							
Ch. 1	Ch. 2	Ch. 3	Ch. 4	Ch. 5	Ch. 6	Ch. 7	Ch. 8	Ch. 9	Ch. 10	Ch. 11	Ch. 12	Ch. 13	Ch. 14	Ch. 15	Ch. 16
Right1	Left	Right2	Right3	M.Pad1	M.Pad2	M.Pad3	M.Pad4	Rhy1	Rhy2	Bass	Chd1	Chd2	Pad	Phr1	Phr2

## Creating a Song (Quick Recording)

Before starting recording, make the desired panel settings for your keyboard performance—selecting a Voice, Style, etc.

- 1 Press the SONG [REC] button and the [STOP] button simultaneously.**

A blank Song for recording is automatically set.

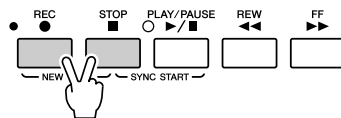

- 2 Press the SONG [REC] button.**

This enables recording of all Tyros3 parts, according to the default MIDI channel assignments (shown in the chart above).

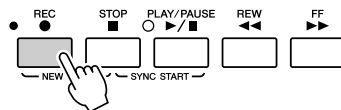

**If you want to record to specific channels or change the MIDI channels assignment:**

While holding the SONG [REC] button, press the [1 ▲▼]–[8 ▲▼] buttons to set the desired channels to “REC”, then assign the desired part to the channel by using the [C]/[D] buttons. (This is called “Multi Recording.”)

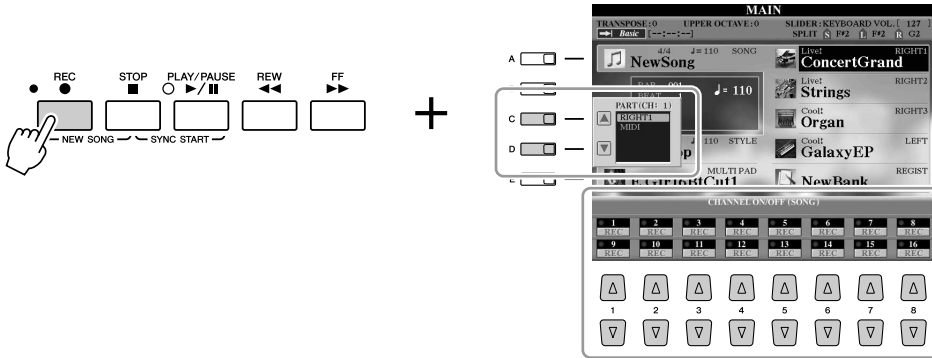

**3 Start recording.**

Recording begins automatically as soon as you play a note on the keyboard, start Style playback or start Multi Pad playback.

**4 Press the SONG [STOP] button to stop recording.**

A message prompting you to save the recorded performance appears. To close the message, press the [EXIT] button

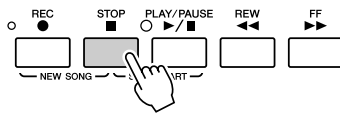

**5 Press the SONG [PLAY/PAUSE] button to play back the recorded performance.**

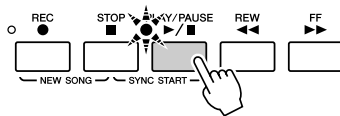

**6 If necessary, re-record a specific channel (or record another channel) of the recorded Song or record an additional section to the end of the recorded Song.**

Repeat steps 2–5 above.

**7 Save the recorded performance as a Song to the USER, HD or USB drive.**

Press one of the SONG [I]–[IV] buttons and call up the USER, HD or USB Page by pressing the TAB [◀|▶] button. Then press the [6 ▼] (SAVE) button to save your performance as a Song file (page 30).

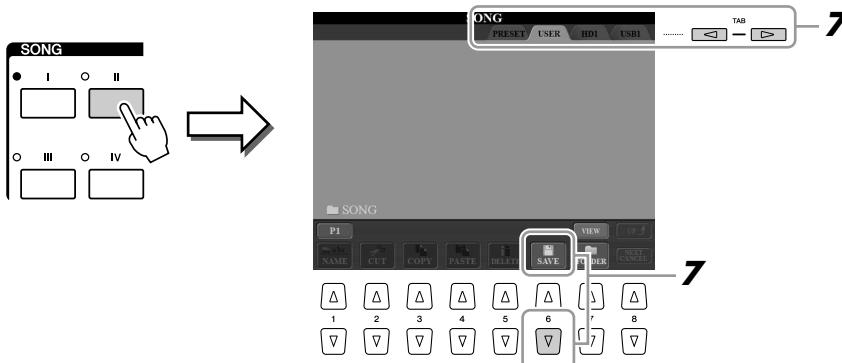

**NOTE**

When recording without Style playback, turning the [METRONOME] on makes your recording sessions much more efficient. The Metronome tempo can be adjusted by TEMPO [-]/[+] buttons.

**CAUTION**

The recorded Song will be lost if you change to another Song or you turn the power off without executing the save operation.

**NOTE**

By default, pressing the SONG [I] button calls up the PRESET Page and pressing one of the [II]–[IV] buttons calls up the USER Page.

# Playback of Songs

You can play back the following types of Songs.

- Preset Songs (in the PRESET Page of the Song Selection display)
- Your own recorded Songs (saved to the USER/HD/USB Page)
- Commercially available Song data: SMF (Standard MIDI File)

**1** Press any of the SONG buttons to call up the Song Selection display.



**2** Press the TAB [◀|▶] buttons to select the location of the desired Song.

If you want to playback of Song in the USB storage device, connect the USB storage device containing MIDI Song data to the USB TO DEVICE terminal beforehand.

**3** Select the desired Song by using the [A]–[J] buttons.

You can also select a Song by using the [DATA ENTRY] dial, then press the [ENTER] button to execute.

**4** Press the SONG [PLAY/PAUSE] button to start playback.

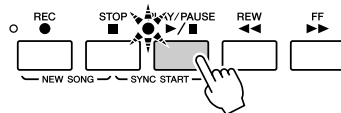

**NOTE**

You can start playback as soon as you start playing the keyboard (SYNC START). Press the [STOP] button and [PLAY/PAUSE] button simultaneously, then play the keyboard to start playback.

**Queuing the next Song for playback**

While a Song is playing back, you can queue up the next Song for playback. This is convenient for chaining it to the next Song smoothly during stage performance. Select the Song you want play next in the Song Selection display, while a Song is playing back. The “NEXT” indication appears at the upper right of the corresponding Song name. To cancel this setting, press the [8 ▼] (NEXT CANCEL) button.

**5** Press the SONG [STOP] button to stop playback.

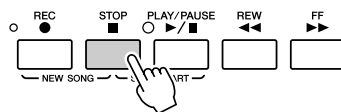

## Operations During Playback

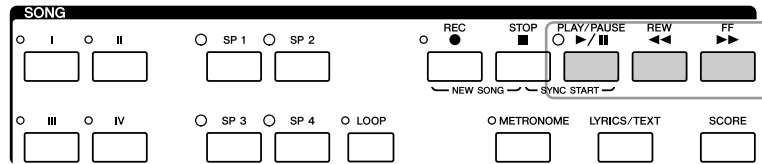

- **Pause** ..... Press the [PLAY/PAUSE] button. Pressing it again resumes Song playback from the current position.
- **Rewind** ..... Press the [REW] button to move back one measure. Hold the [REW] button to scroll backward continuously.
- **Fast Forward** ..... Press the [FF] button to move forward one measure. Hold the [FF] button to scroll forward continuously.

Pressing the [REW] or [FF] button calls up a pop-up window showing the current measure number (or Phrase Mark number) in the display. While the Song Position pop-up is shown on the display, you can also use the [DATA ENTRY] dial to adjust the value.

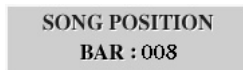

For Songs not containing Phrase Marks



For Songs containing Phrase Marks

You can switch between BAR and PHRASE MARK by pressing the [E] button.

### NOTE

You can have Song playback fade in/out or change the tempo (page 51).

### NOTE

You can adjust the Song volume balance between the Song and Keyboard. See page 55.

### NOTE

You can also turn the specific part(s) on or off. See page 63.

### NOTE

Phrase Mark is a pre-programmed marker in a certain Song data, which specifies a certain location in the Song.

### Restrictions for protected Songs

Commercially available Song data may be copy protected to prevent illegal copying or accidental erasure. They are marked by the indications at the upper left side of the file names. The indications and relevant restrictions are detailed below.

- **Prot. 1:** Indicates Preset Songs saved to the User drive. These cannot be copied/moved/saved to external devices.
- **Prot. 2 Orig:** Indicates Yamaha-protection-formatted Songs. These cannot be copied. These can be moved/saved only to the User drive and USB storage devices with ID.
- **Prot. 2 Edit:** Indicates edited “Prot. 2 Orig” Songs. Make sure to save these to the same folder containing the corresponding “Prot. 2 Orig” Song. These cannot be copied. These can be moved/saved only to the User drive and USB storage devices with ID.

#### Note for “Prot. 2 Orig” and “Prot. 2 Edit” Song file operation

Make sure to save the “Prot. 2 Edit” Song to the same folder containing its original “Prot. 2 Orig” Song. Otherwise the “Prot. 2 Edit” Song cannot be played back. Also, if you move a “Prot. 2 Edit” Song, be sure to move its original “Prot. 2 Orig” Song to the same location (folder) at the same time.

For information about compatible USB storage devices for saving protected Songs, visit the Yamaha website.

## Displaying Music Notation (Score)

You can view the music notation (score) of the selected Song.

- 1 Select a Song (steps 1–3 on page 59).**
- 2 Press the [SCORE] button to call up the Score display.**

As starting playback, the “ball” bounces along through the score, indicating the current position.

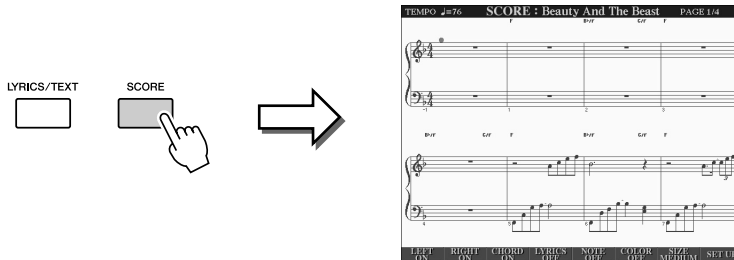

You can change the displayed notation style by using the [1 ▲▼]–[8 ▲▼] buttons. For details, refer to the Reference manual on the website.

### NOTE

You can look through the entire notation by using the TAB [◀▶] buttons when the Song playback is stopped.

### NOTE

The displayed notation is generated by the Tyros3 based on the Song data. As a result, it may not be exactly the same as commercially available sheet music of the same Song—especially when displaying notation of complicated passages or many short notes.

## Displaying Lyrics (Text)

When the selected Song contains lyric data, you can view it on the Tyros3 display during playback. Even if the Song doesn't contain lyrics data, you can view the lyrics on the display by loading the text file (.txt) created on a computer via USB storage device.

- 1 Select a Song (steps 1–3 on page 59).**
- 2 Press the [LYRICS/TEXT] button to call up the Lyrics display.**

When the Song data contains lyrics data, the lyrics are shown on the display. As Song playback starts, the color of the lyrics changes, indicating the current position.

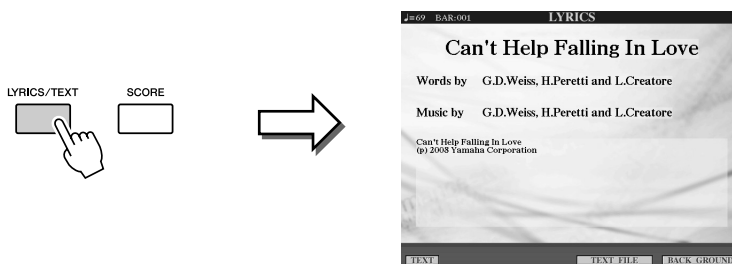

### NOTE

You can look through the entire lyrics by using the TAB [◀▶] buttons when the Song playback is stopped.

When you want to view the text file created on your computer, press the [5 ▲▼]/[6 ▲▼] (TEXT FILE) button to select the desired text file, then press the [1 ▲▼] (TEXT) button to display the selected file.

For more information about the Lyrics display, refer to the Reference manual on the website.

### NOTE

The Lyrics (text) can be displayed on the external monitor. See page 90.

## Using Song Position Markers

Song Position markers (SP 1–SP 4) can be placed in the Song data. This not only lets you navigate quickly and easily through the Song data, but also lets you set up convenient playback loops—allowing you to create dynamic Song arrangements “on the fly,” as you perform.

### Entering Song Position Markers

**1** Select a Song and start playing back (steps 1–4 on page 59).

**2** When the Song reaches the point you wish to enter a marker, double-click (press twice quickly) one of the [SP 1]–[SP 4] buttons during playback.

The corresponding button flashes in green, and the marker for that button is entered to the 1st beat of the appropriate measure.

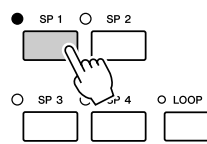

Continue to enter other markers in the same way.

**3** Stop song playback by pressing the [STOP] button.

**4** Save the Song (step 7 on page 58).

#### NOTE

If a marker has already been entered to the button, the lamp is lit in green or red. Double-clicking on the button will set the marker to a new song position.

#### NOTE

You can also enter the marker when the Song playback is stopped at the desired position, by double-clicking any of the [SP 1]–[SP 4] buttons. The marker is entered at the top of the current measure.

#### CAUTION

The entered marker settings will be lost if you change to another Song or you turn the power off without executing the save operation.

### Jumping to a Marker During Playback

Simply pressing the one of the [SP 1]–[SP 4] buttons during song playback jumps to the corresponding position, after the current played measure reaches its end. (The button will blink in red, indicating that playback jump is ready.) You can cancel the jump by pressing the same SP button again before the actual jump.

#### About the lamp status of the SP buttons

- **Red:** The Song Position has been passed and song playback continues to the next Song Position.
- **Green:** Song Position is memorized to the button.
- **Off:** Song Position is not memorized to the button.

### Starting Playback from a Specific Marker

First press the desired SP button (while song playback is stopped), then press the [PLAY/PAUSE] button.

## Using Markers in Loop Playback

In this section, the loop playback method is explained as an example of loop playback between SP 1 and SP 2.

**1** Press the [PLAY/PAUSE] button to start playback from the top of the Song.

**2** After passing the [SP 1] point, press the [LOOP] button to turn the loop function on.

The Song plays back up to the [SP 2] point, then goes back to [SP 1] and loops between the two points.

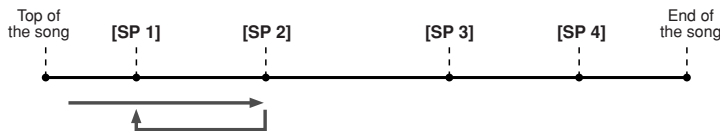

**3** To turn the loop function off, press the [LOOP] button again.

When you turn it off, playback continues past the [SP 2] point.

## Turning Song Channels On/Off

**1** Press the [CHANNEL ON/OFF] button once or twice to call up the CHANNEL ON/OFF (SONG) display.

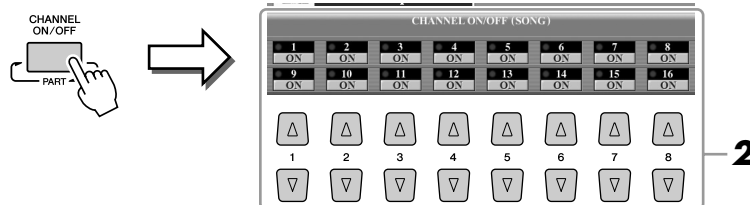

**2** Use the [1 ▲▼]–[8 ▲▼] button to turn each channel on or off.

If you want to play back only one particular channel (solo playback), press and hold down one of the [1 ▲▼]–[8 ▲▼] buttons corresponding to the desired channel. Only the selected channel is turned to on and others are off. To cancel solo playback, press the same button again.

### Advanced Features

Refer to the Reference Manual on the website.

Editing Music Notation settings [SCORE] → [1 ▲▼]–[8 ▲▼] buttons

Editing Lyrics display settings [LYRICS] → [1 ▲▼]–[8 ▲▼] buttons

Song Playback related parameters (Repeat settings, Channel settings, Guide function, etc.) [FUNCTION] → [B] SONG SETTING

#### Creating/Editing Songs (Song Creator)

- Recording Melodies (Step Recording): [DIGITAL RECORDING] → [A] SONG CREATOR → TAB [◀|▶] 1–16
- Recording Chords (Step Recording): [DIGITAL RECORDING] → [A] SONG CREATOR → TAB [◀|▶] CHORD
- Re-Recording a Specific Section—Punch In/Out: [DIGITAL RECORDING] → [A] SONG CREATOR → TAB [◀|▶] REC MODE
- Editing Channel Events: [DIGITAL RECORDING] → [A] SONG CREATOR → TAB [◀|▶] CHANNEL
- Editing Chord events, Notes, System Exclusive events and Lyrics: [DIGITAL RECORDING] → [A] SONG CREATOR → TAB [◀|▶] CHORD, 1–16, SYS/EX. or LYRICS

# Multi Pads

– Adding Musical Phrases to Your Performance –

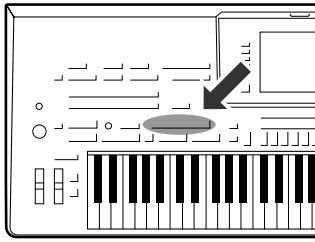

The Multi Pads can be used to play a number of short pre-recorded rhythmic and melodic sequences that can be used to add impact and variety to your keyboard performances.

Multi Pads are grouped in Banks or four each. The Tyros3 features a variety of Multi Pad Banks in a variety of different musical genres.

## Playing the Multi Pads

- 1 Press the MULTI PAD CONTROL [SELECT] button to call up the Multi Pad Bank Selection display, then select the desired bank.**

Select pages using the [1 ▲]–[6 ▲] buttons that correspond to “P1, P2...” in the display or pressing the MULTI PAD CONTROL [SELECT] button repeatedly, then use the [A]–[J] buttons to select the desired bank.

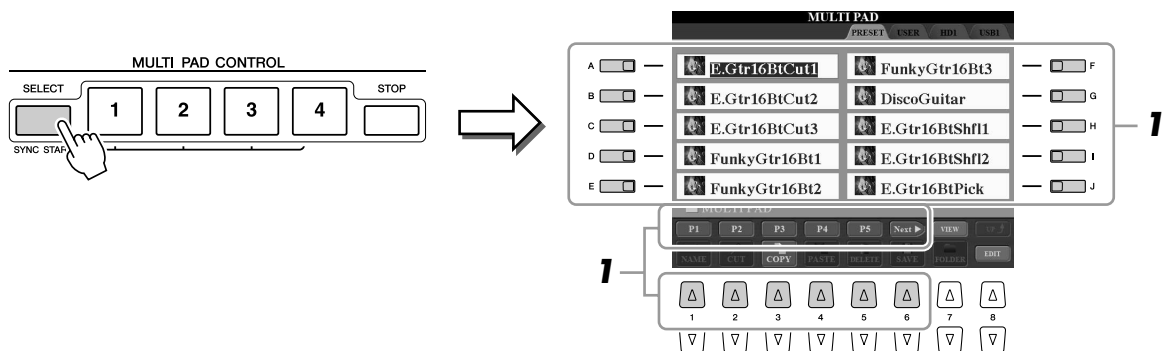

- 2 Press any of the MULTI PAD CONTROL [1]–[4] buttons to play a Multi Pad phrase.**

The corresponding phrase (in this case, for Pad 1) starts playing back in its entirety at the currently set tempo. You can even play two or more Multi Pads at the same time.

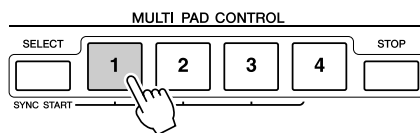

- 3 Press the [STOP] button to stop playback of the Multi Pad(s).**

If you want to stop specific pads, simultaneously hold down the [STOP] button and press the pad(s) you wish to stop.

### NOTE

There are two types of Multi Pad data. Some types will play back once and stop when they reach to the end. Others will be play back repeatedly.

### NOTE

Pressing the pad during its playback will stop playing and begin playing from the top again.

### About the color of the Multi Pads

- **Green:** Indicates that the corresponding pad contains data (phrase).
- **Red:** Indicates that the corresponding pad is playing back.
- **Red (flashing):** Indicates that the corresponding pad is in standby (Synchro Start).



## Using the Multi Pad Synchro Start Function

While holding the MULTI PAD CONTROL [SELECT] button, press one of the MULTI PAD CONTROL [1]–[4] buttons to put the Multi Pad playback in standby. The corresponding button will flash in red. You can even play two, three, or four Multi Pads at the same time.

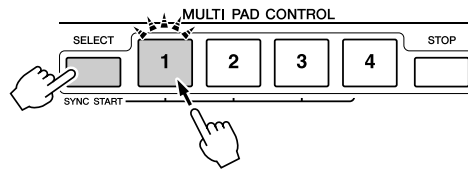

The Multi Pad currently set to standby will start playing when you play back a Style, press any note on the keyboard (when [ACMP] is off), or play a chord with your left hand (when [ACMP] is on). If you put the Multi Pad in standby during Song/Style playback, pressing any note on the keyboard will start the Multi Pad playback at the top of next bar.

When two or more Multi Pads are in standby, pressing one of them simultaneously starts all Multi Pads that are set to standby.

To cancel Synchro Start, while holding the MULTI PAD CONTROL [SELECT] (or [STOP]) button, press one of the [1]–[4] buttons. Pressing the MULTI PAD CONTROL [STOP] button once cancels Synchro Start of all buttons.

## Using Chord Match

Many of the Multi Pad phrases are melodic or chordal and you can have these phrases automatically change chords along with the chords you play with your left hand. When the [ACMP] is on or LEFT part is on, simply play a chord with your left hand and press any of the Multi Pads—Chord Match changes the pitch to match the chords you play. Keep in mind that some Multi Pads are not affected by Chord Match.

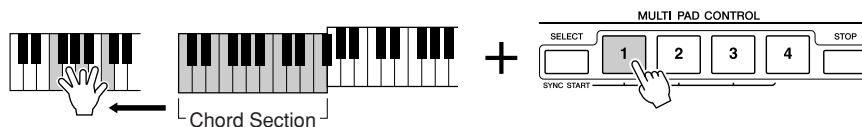

In this example, the phrase for Pad 1 will be transposed into F major before playing back. Try out other various chord types while playing the Multi Pads.

### Advanced Features

Refer to the Reference Manual on the website.

Multi Pad creating (Multi Pad Creator):

[DIGITAL RECORDING] → [C] MULTI PAD CREATOR

Multi Pad editing:

Multi Pad Bank Selection display → [8 ▼] (EDIT)

# Music Finder

– Calling Up Ideal Setups for Your Music –

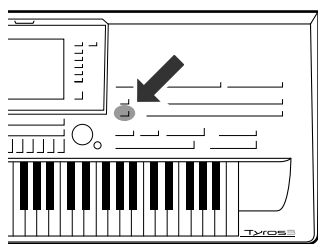

If you want to play in a certain genre of music but don't know which Style and Voice settings would be appropriate, the convenient Music Finder function can help you out. Simply select the desired music genre from among the "Records," and the Tyros3 automatically makes all appropriate panel settings to let you play in that music style!

## Selecting the Desired Music Genre from the Record List

- 1 Press the [MUSIC FINDER] button to call up the MUSIC FINDER display.

In the ALL tab, the preset records are shown.

Shows music genre (or song title) and information of the Style assigned to each record.

MUSIC	STYLE	BEAT	TEMPO
40th Symphony	PopClassics	4/4	124
41st Symphony	ClassicalMenuet	3/4	122
60 Second Waltz	VienneseWaltz1	3/4	240
69 Summers Long	PowerRock	4/4	130
A Boy From The Country	Bluesgrass	2/4	150
A Bridge To Cross Troubled	PowerBallad	4/4	78
A Bright & Guiding Light	EasyListening	4/4	76
A Cozy Life In Italy	OrganBallad	4/4	88
A Day's Difference	POP/TV Theme	4/4	126
A Divorce In The Country	Country/Swing2	4/4	120
A Feeling Of Love Tonight	MovieBallad	4/4	110
A Fire Lighter	Unplugged1	4/4	110
A Great	Orch/JazzBallad	4/4	110

Shows the number of records.

2

- 2 Select the desired Record by using the [2 ▲▼]/[3 ▲▼] buttons.

You can also use the [DATA ENTRY] dial and the [ENTER] button.

### Sorting the records

Press [F] (SORT BY) button to sort the records by MUSIC, STYLE, BEAT and TEMPO. Press the [G] (SORT ORDER) button to change the order of the records (ascending or descending).

When sorting records by MUSIC, you can use the [1 ▲▼] button to skip up or down through the songs alphabetically. When sorting records by STYLE, you can use the [4 ▲▼]/[5 ▲▼] button to skip up or down through the Styles alphabetically. Simultaneously press the [▲] and [▼] buttons to move the cursor to the first record.

- 3 Play the keyboard.



### NOTE

If you want to avoid changing the Tempo during Style playback when selecting another record, turn on the Tempo Lock function by pressing the [I] (TEMPO LOCK) button in the Music Finder display.

# Searching the Record

You can search the records by specifying a song name or keyword, using the Search function of the Music Finder.

**1** From the ALL tab of the MUSIC FINDER display, press the [6 ▲] (SEARCH 1) button to call up the Search display.

**2** Enter the search criteria.

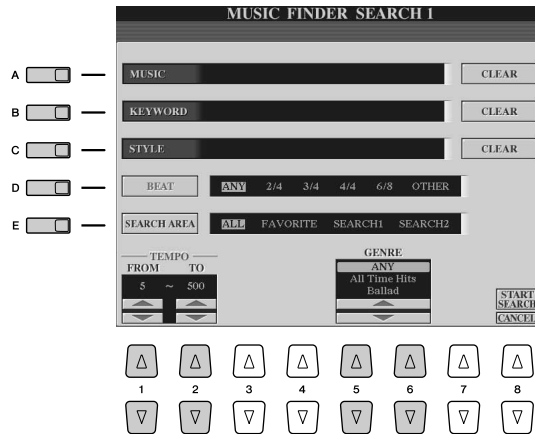

[A]	MUSIC	Searches by song name/keyword. Pressing one of these buttons calls up the pop-up window to enter the song name/keyword. To clear the entered Music/Keyword, press the [F]/[G] (CLEAR) button.
[B]	KEYWORD	
		<b>NOTE</b> You can search several different Keywords simultaneously by inserting a separator (comma) between each.
[C]	STYLE	Searches by Style. Pressing this button calls up the Style Selection display. After selecting the desired Style, press the [EXIT] button to return back to the Search display. To clear the entered Style, press the [H] (CLEAR) button.
[D]	BEAT	Specifies the time signature for the search.
[E]	SEARCH AREA	Selects a specific location for searching.
[1 ▲▼]	TEMPO FROM	Sets the range of the tempo you want to use for the search.
[2 ▲▼]	TEMPO TO	
[5 ▲▼]/ [6 ▲▼]	GENRE	Selects the desired music genre.

**3** Press the [8 ▲] (START SEARCH) button to start the search.

The Search 1 display appears, showing the results of the search. To cancel searching, press the [8 ▼] (CANCEL) button.

**NOTE**

If you wish to further narrow down your search or search another music genre, press the [6 ▼] (SEARCH 2) button in the Music Finder display.

**Advanced Features**

Refer to the Reference Manual on the website.

Creating a set of favorite Records: MUSIC FINDER display → [H] (ADD TO FAVORITE)

Editing Records: MUSIC FINDER display → [8 ▲▼] (RECORD EDIT)

Saving the Record as a single file: MUSIC FINDER display → [7 ▲▼] (FILES)

Viewing record information on the Internet: MUSIC FINDER display → [J] (MUSIC FINDER +)

# Registration Memory

## – Saving and Recalling Custom Panel Setups –

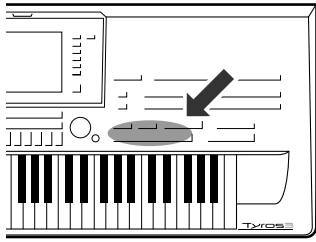

The Registration Memory function allows you to save (or “register”) virtually all panel settings to a Registration Memory button, and then instantly recall your custom panel settings by simply pressing a single button. The registered settings for eight Registration Memory buttons should be saved as a single Bank (file).

### Registering Your Panel Setups

- 1 Set up the panel controls (such as Voice, Style, effects, and so on) as desired.
- 2 Press the [MEMORY] button above the REGISTRATION MEMORY section.

The display for selecting the items to be registered appears.

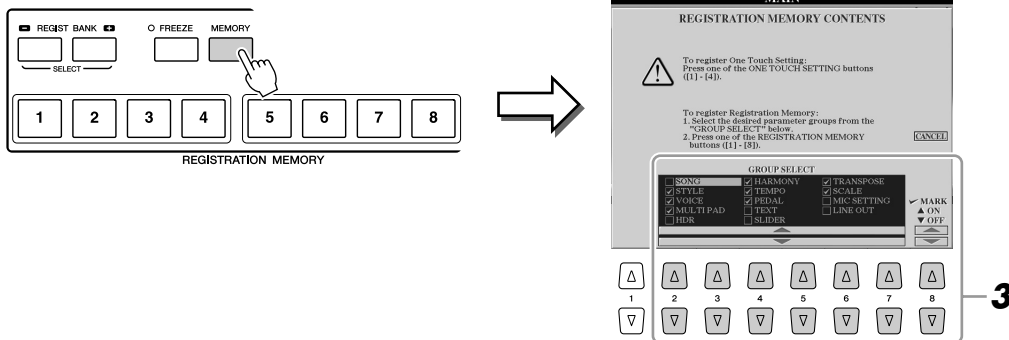

- 3 Determine the items you want to register.

Select the desired item by using the [2 ▲▼]–[7 ▲▼] buttons, then enter or remove the checkmark by using the [8 ▲] (MARK ON)/ [8 ▼] (MARK OFF) buttons.

To cancel the operation, press the [I] (CANCEL) button.

- 4 Press one of the REGISTRATION MEMORY [1]–[8] buttons to which you wish to memorize the panel setup.

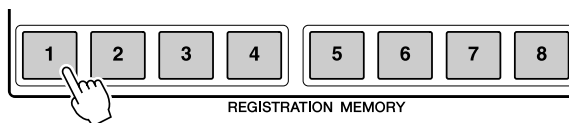

The memorized button becomes red, which indicates the number button contains data and its number is selected.

#### **CAUTION**

If you select the button whose lamp is lit in red or green here, the panel setup previously memorized to the button will be erased and replaced by the new settings.

### About the lamp status

- **Red:** Data registered and currently selected
- **Green:** Data registered but not currently selected
- **Off:** No data registered

## 5 Register various panel setups to other buttons by repeating steps 1–4.

The registered panel setups can be recalled by simply pressing the desired number button.

### NOTE

The panel setups registered in the numbered buttons are preserved even when you turn off the power. If you want to delete all the eight current panel setups, turn the [POWER] button on while holding the B5 key (right-most B key on the keyboard).

## Saving the Registration Memory as a Bank file

You can save all the eight registered panel setups as a single Registration Memory Bank file.

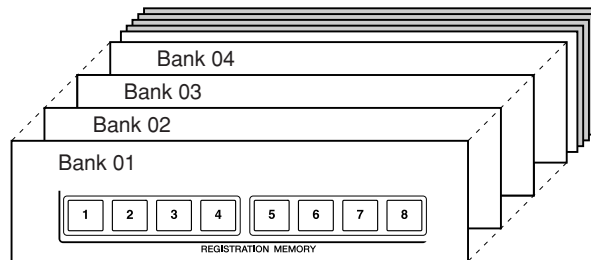

## 1 Press the REGIST BANK [+] and [-] buttons simultaneously to call up the Registration Bank Selection Display.

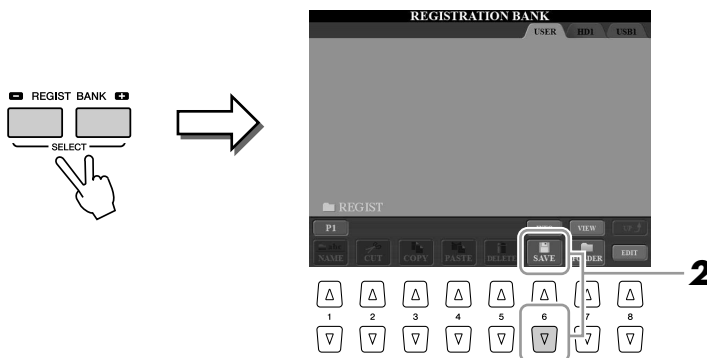

## 2 Press the [6 ▼] (SAVE) button to save the Bank file (page 30).

## Recalling a Registered Panel Setup

The saved Registration Memory Bank files can be recalled by using the REGIST BANK [-]/[+] buttons or the following procedure.

- 1** Press the REGIST BANK [+] and [-] buttons simultaneously to call up the REGISTRATION BANK Selection Display.
- 2** Press one of the [A]–[J] buttons to select a Bank.
- 3** Press one of the green-lit numbered buttons ([1]–[8]) in the Registration Memory section.

**NOTE**

Turning the [FREEZE] button on disables recall of specific item(s). To use this function, you need to select the item(s) not to be recalled by accessing [FUNCTION] → [E] REGIST SEQUENCE/FREEZE/VOICE SET → TAB [◀▶] FREEZE.

## Confirming the Registration Memory Information

You can call up the information display to take a look which Voices and Style are memorized to the [1]–[8] buttons of a Registration Memory Bank.

- 1** Simultaneously press the REGIST BANK [+] and [-] buttons to call up the Registration Bank Selection display, then use the [A]–[J] buttons to select the desired Bank.

You can also use the [DATA ENTRY] dial and the [ENTER] button to select a Bank.

- 2** Press the [6 ▲] (INFO) button to call up the information display.

**NOTE**

You can instantly call up the information display of the currently selected Registration Memory Bank by pressing the [DIRECT ACCESS] button and one of the REGISTRATION MEMORY [1]–[8] buttons in sequence.

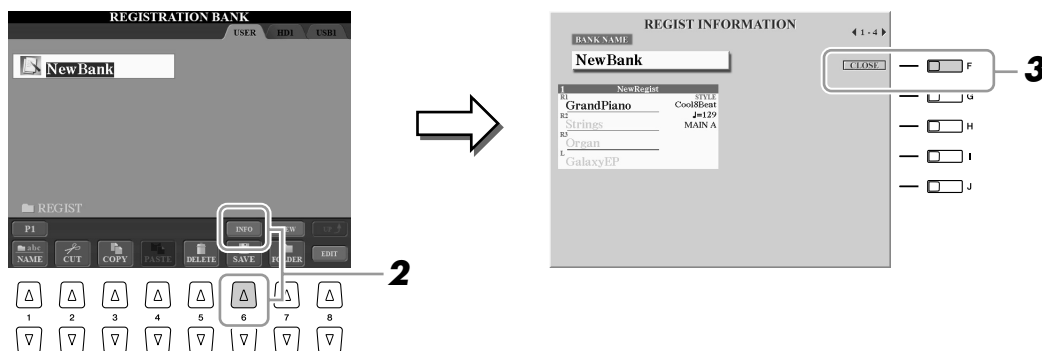

By using the TAB [◀▶] buttons, you can switch between the two information display pages: information for the Registration Memory [1]–[4] buttons and information for the [5]–[8] buttons.

**NOTE**

The grayed Voice indicates that the corresponding Voice part is off, while black indicates the part is on.

- 3** Press the [F] (CLOSE) button to close the information display.

**Advanced Features**

Refer to the Reference Manual on the website.

Disabling recall of specific items:

[FUNCTION] → [E] REGIST SEQUENCE/FREEZE/VOICE SET → TAB [◀▶] FREEZE

Calling up Registration Memory numbers in order:

[FUNCTION] → [E] REGIST SEQUENCE/FREEZE/VOICE SET → TAB [◀▶] REGISTRATION SEQUENCE

# Recording Audio with the Hard Disk Recorder

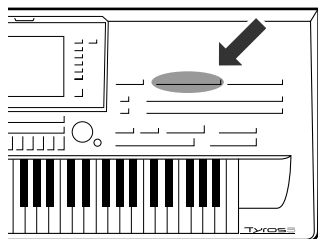

Here you'll learn how to record your performance as audio data to an installed hard disk drive. For example, by connecting a guitar, microphone or other device to the instrument, you can record an ensemble performance of guitar and keyboard together or record yourself singing along with Song playback. The Hard Disk Recorder function gives you two tracks to work with: Main and Sub. By effective use of the Bounce Recording feature, you can mix down previous takes and record many more than just two tracks, one by one. The performance data is saved as a WAV file of conventional CD quality (44.1 kHz/16 bit). You can also export the recorded data to a USB storage device, then play and even edit the recorded performance on computer.

The following sounds can be recorded.

- Internal sound of the Tyros3 (Keyboard parts (Right 1, Right 2, Right 3, Left), Multi Pad, Song parts, Style parts)
- Input from a microphone, guitar or other instrument (via the [LINE IN/MIC] jack).
- Input from another audio device, such as a CD player, digital audio player or the like (via the [LINE IN/MIC] jack).

## Recording Your Performance

This section explains how to record your performance to the Hard Disk Recorder. For example, you can first record your keyboard performance to the Main track, then record your voice (vocal) to the Sub track by the procedure described below. You can record a maximum of 80 minutes to one audio song.

### 1 Set the desired Voice, Style, etc. which you want to use for your performance.

For instructions on selecting a Voice, see page 36. For instructions on selecting a Style and using auto accompaniment, see page 48.

#### **IMPORTANT**

For recording, your hard disk drive should have at least 50 MB. Make sure there is enough available space on the hard disk:  
[FUNCTION] → [I] UTILITY → TAB [◀▶] MEDIA → [F] PROPERTY.

### 2 Press the HARD DISK RECORDER [SETTING] button to call up the Audio Setting display.

By playing the keyboard, you can check the signal on the REC MONITOR meter.

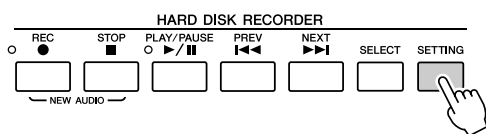

### 3 Press the HARD DISK RECORDER [REC] and [STOP] buttons simultaneously.

This creates an audio file for recording.

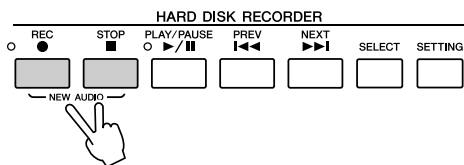

These buttons are also marked [NEW AUDIO], since they let you create a new audio file.

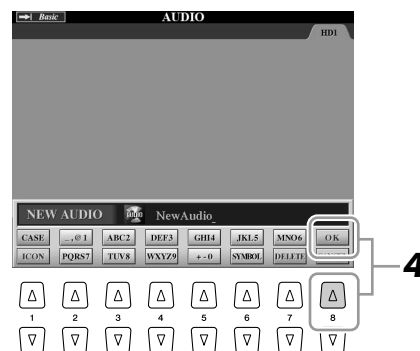

### 4 Enter a name for the new file and press the [8 ▲] (OK) button.

For instructions on naming, see page 34.

#### NOTE

Keep in mind that even if you don't save the recorded data after the recording is finished (in step 9 or 19), a file with the name specified here will still remain on the hard disk drive. In other words, the file exists on the hard disk drive, but is empty (since it has not been properly saved).

### 5 Press the [REC] button to enable recording.

The REC MODE Page is automatically called up. Now you are ready to record.

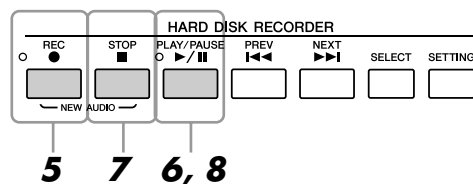

#### NOTE

To cancel recording, press the [REC] button again.

### 6 Press the [PLAY/PAUSE] button to start recording.

Start the Style and play the keyboard.

### 7 When finished recording, press the [STOP] button.

### 8 To hear your new recording, press the [PLAY/PAUSE] button.

#### CAUTION

Do not connect or disconnect the USB storage device during audio song playback or recording. Doing so may cause incorrect playback of the song.

#### Undo/Redo

If you've made a mistake or you're not completely satisfied with your performance, you can use the Undo function to erase the take and try again (starting with Step 5 above).

**1** Use the TAB [◀|▶] button to select the REC MODE Page.

**2** Press the [H] (UNDO) button.

The latest recording that you made is cancelled. If you want to redo the operation, press the [H] (REDO) button just after the UNDO operation.



- 9** Press the [I] (SAVE) button to save the new recording, then at the prompt, press the [G] (OK) button.

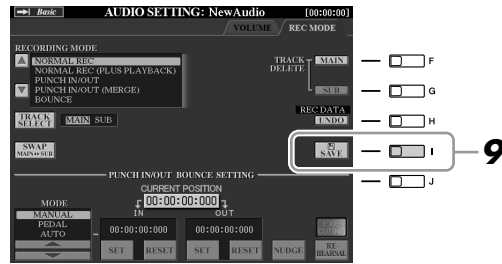

Next, let's record your singing to the Sub track. You can record your vocals while listening to playback of the Main track (recorded in steps above).

- 10** Connect a microphone to the [L/L+R/MIC] jack on the rear panel.

Adjust the [TRIM] control on the rear panel and the [INPUT VOLUME] on the front panel while singing in to the microphone. For details about connecting a microphone, refer to page 91.

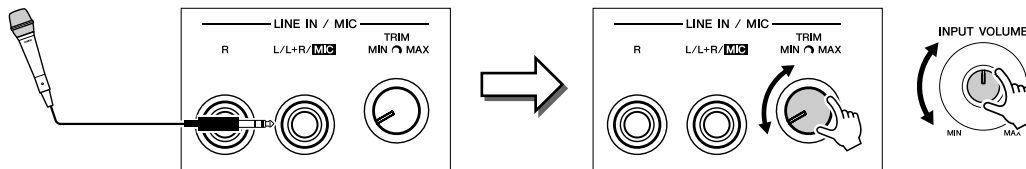

- 11** Use the TAB [◀|▶] buttons to call up the VOLUME Page.

- 12** Practice the part (sing into the microphone) and check the levels on the REC MONITOR meter.

Check that the level doesn't constantly go into the "red" and light up the indicator. If it does, you may have to turn the microphone input level down a bit.

- 13** Use the TAB [◀|▶] buttons to call up the REC MODE Page.

- 14** Press the [C] (TRACK SELECT) button to set the destination track to "SUB."

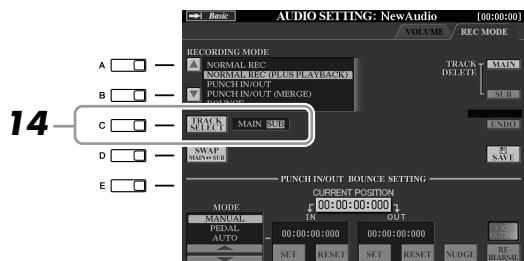

**NOTE**

Make sure that the RECORDING MODE (upper left of the display) is set to "NORMAL REC" or "NORMAL REC (PLUS PLAYBACK)" here.

- 15** Press the [REC] button to enable recording.

- 16** Press the [PLAY/PAUSE] button to start recording.

Sing along with the Main track playback.

- 17** When finished recording, press the [STOP] button.
- 18** To hear your new recording, press the [PLAY/PAUSE] button.

#### Adjusting volume balance

In the VOLUME Page, you can adjust the volume of Main and Sub tracks separately. Use the [3 ▲▼]/[4 ▲▼] buttons or sliders to adjust the Main/Sub track volume. By using the [2 ▲▼]/[5 ▲▼] buttons, you can also mute the Main/Sub tracks.

- 19** Press the [I] (SAVE) button to save the new recording, then at the prompt, press the [G] (OK) button.

Next, mix all data from the Main track and Sub track to one track (Main track). The procedure below is called “Bounce Recording.”

- 20** In the REC MODE Page, use the [A]/[B] buttons to select “BOUNCE.”

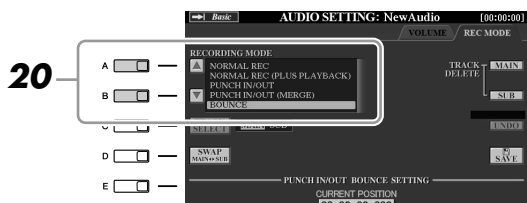

- 21** Press the [REC] button to enable recording.

- 22** Press the [PLAY/PAUSE] button to start recording.

All data in Main and Sub track are mixed and recorded to the Main track. When the playback of both tracks finished, Bounce recording automatically stops.

- 23** To hear your new recording, press the [PLAY/PAUSE] button.

At this point, the data of Sub track is recorded to both Main and Sub tracks. To avoid duplicate playback of Sub track, press the [5 ▲▼] (SUB MUTE) button in the VOLUME Page.

- 24** In the REC MODE Page, press the [G] (TRACK DELETE SUB) button to delete the Sub track.

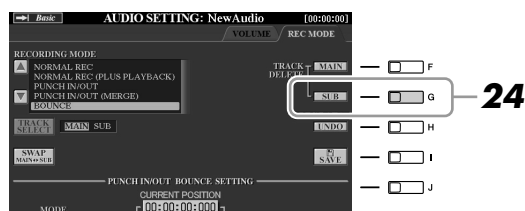

- 25** Press the [I] (SAVE) button to save the recording.

Now all the data recorded to Main and Sub tracks are merged and recorded to only the Main track. Since the Sub track is now empty, you can continue recording another part to the Sub track, repeating steps 13–19 above.

#### NOTE

If you sing or play the keyboard during the Bounce Recording, your performance is also recorded to the Main track.

## Audio Data Playback

- 1 Press the HARD DISK RECORDER [SELECT] button, then use the [A]–[J] buttons to select the desired audio file.

### Confirming the Audio Property

By pressing the [7 ▲] (PROPERTY) button here, you can check the property information (file name, location, sample rate etc.) of the selected file. To close the property display, press the [F] (OK) button.

- 2 Press the HARD DISK RECORDER [PLAY/PAUSE] button to start playback.

To stop the playback, press the [STOP] button.

## Selecting the Previous/Next Audio Song

Press the HARD DISK RECORDER [PREV]/[NEXT] button. This only selects the previous/next song in the same folder level.

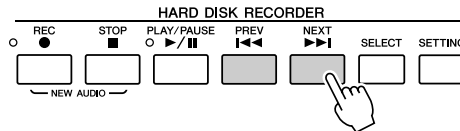

Keep in mind that these buttons cannot be used when the VOLUME, REC MODE or START END POINT display is shown.

## Adjusting the Playback Volume

- 1 Press the [BALANCE] button once or twice to call up the BALANCE (2/2) display.

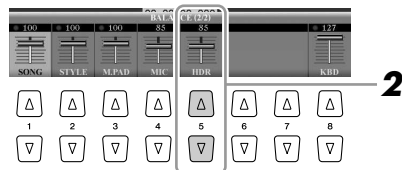

- 2 Use the [5 ▲▼] slider or buttons to adjust the HDR (Hard Disk Recorder) playback volume.

- 3 Press the [EXIT] button to close the BALANCE display.

### NOTE

When the Main display is shown, the BALANCE display cannot be closed.

## Exporting an Audio File to a USB Storage Device

This function allows you to transfer your recorded audio to a computer via a USB storage device, for further editing and/or recording. The data which can be exported are in stereo WAV format (44.1 kHz sample rate and 16-bit resolution).

Only the Main track can be exported. If you want to export the Sub track, you have to replace the Main and Sub track (by pressing the [D] button in REC MODE Page) in advance, or do Bounce Recording (refer to steps 20–22 on page 74) to record the data of Sub track to Main track.

- 1** Insert a USB storage device to the USB TO DEVICE terminal.
- 2** Press the HARD DISK RECORDER [SELECT] button to call up the AUDIO display.

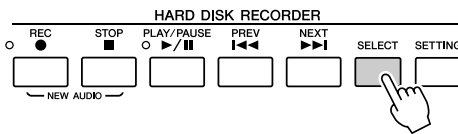

If necessary, select the desired folder in the display.

- 3** Press the [8 ▼] (CHANGE MENU) button if necessary, then press the [5 ▼] (EXPORT) button to call up the Export function.

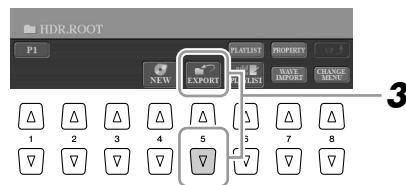

- 4** Select the desired audio file by using the [A]–[J] buttons.

The selected file name is highlighted. You can continue to select additional files here, as many as desired. If multiple pages (P1, P2, ...) are shown at the bottom, you can select files from these displays, too.

If you want to select all files in the current folder, press the [6 ▼] (ALL) button.

- 5** After you finish the selection, press the [7 ▼] (OK) button.

- 6** Select the desired destination for exporting by using the TAB [◀|▶] buttons.

Generally, a USB storage device will show up as “USB1” in the display. When the device is selected, all folders and audio files on the device are automatically shown. If necessary, you can specify the desired folder by using the [A]–[J] buttons.

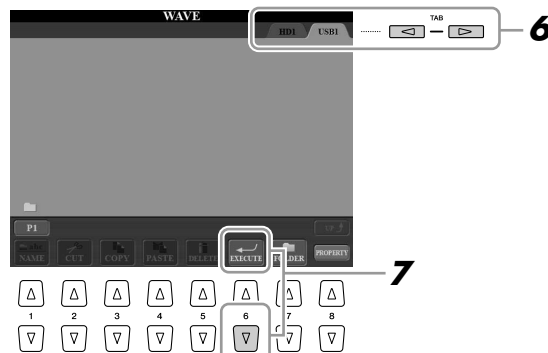

## 7 Press the [6 ▼] (EXECUTE) button to export the file(s).

Exporting may take as little as a couple of seconds or as long as a few minutes, depending on the file size, as well as the number of files you are exporting.

### CAUTION

Do not disconnect the device while the READ/WRITE lamp is on or flashing. Doing so may result in loss or corruption of the data or malfunction of the device.

### NOTE

If you are exporting multiple files and you cancel Export while the operation is in process, some of the files will be exported and unaffected by cancelling the operation.

#### Advanced Features

Refer to the Reference Manual on the website.

Importing an audio file:

HARD DISK RECORDER [SELECT] → [8 ▼] (CHANGE MENU) → [7 ▼] (WAVE IMPORT)

Editing the recorded data:

- Normalize/Adjusting the volume:
- Replacing the Main/Sub tracks/Deleting a track:

HARD DISK RECORDER [SETTING] → TAB [◀|▶] VOLUME

HARD DISK RECORDER [SETTING] → TAB [◀|▶] REC MODE

Re-recording:

HARD DISK RECORDER [SETTING] → TAB [◀|▶] REC MODE → [A]/[B] RECORDING MODE

Setting the start/end points of the audio:

HARD DISK RECORDING [SELECT] → [7 ▲] (PROPERTY) → [H] (START/END POINT)

Playlist Mode:

- Creating a Playlist:
- Playing a Playlist:

HARD DISK RECORDER [SELECT] → [8 ▼] (CHANGE MENU) → [6 ▼] (add to PLAYLIST)

HARD DISK RECORDER [SELECT] → [8 ▼] (CHANGE MENU) → [6 ▲] (PLAYLIST)



# Mixing Console

## – Editing the Volume and Tonal Balance –

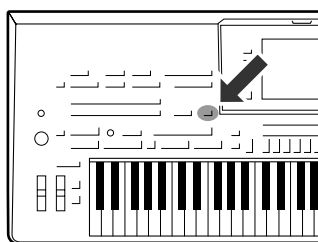

There are many components that make up the overall sound of the Tyros3. These include MIDI sequence data from the Styles, Songs, and Multi Pads, and audio input from a microphone, as well as the various parts of your keyboard performance. The Mixing Console gives you control over the volume and pan settings of each of these components—and some other settings as well—letting you fine-tune the overall sound of the Tyros3.

### Basic Procedure

- 1 Press the [MIXING CONSOLE] button to call up the MIXING CONSOLE display.

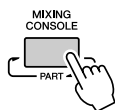

- 2 Use the TAB [◀|▶] buttons to call up the desired page.

For details about each display Page, refer to the Reference Manual on the website.

- **VOL/VOICE**..... Changes the Voice for each part and adjusts panning and volume for each part. Using the Auto Revoice function, you can also convert the sound of commercially available XG song to the special sound using Tyros3's special Voices.
- **FILTER**..... Adjusts the Harmonic Content (resonance) and sound brightness.
- **TUNE**..... Pitch-related settings (tuning, transpose, etc.).
- **EFFECT**..... Selects effect type and adjusts its depth for each part.
- **EQ**..... Adjusts equalization parameters to correct the tone or timbre of the sound.
- **CMP**..... This is the Master Compressor setting which determines the dynamics of overall sound. See page 80.
- **LINE OUT**..... You can specify the output of each part to any of the LINE OUT jacks. For Drum Parts, you can even select specific instruments to be output through any LINE OUT jack.

**NOTE**

The Master Compressor is not applied to audio playback (page 75).

### 3 Press the [MIXING CONSOLE] button repeatedly to call up the MIXING CONSOLE display for the relevant parts.

The part name is indicated at the top of the display.

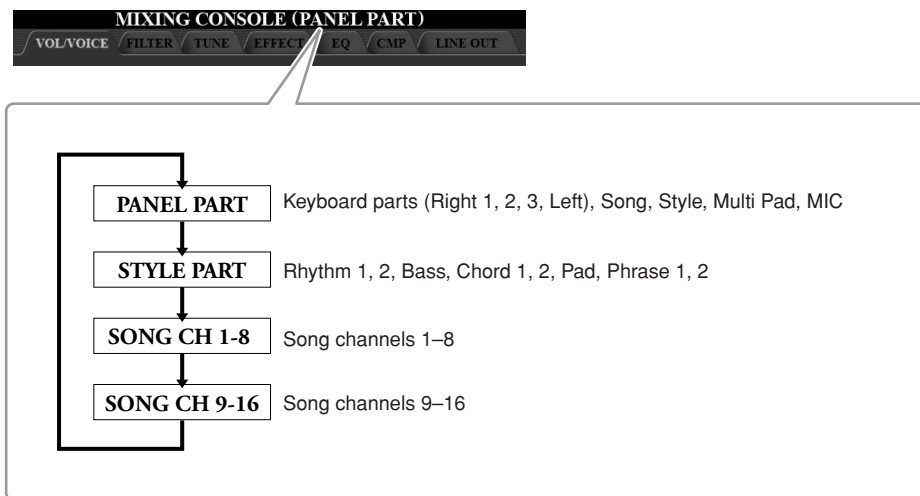

### 4 Use the [A]–[J] buttons to select a parameter, then use the [1]–[8] sliders/buttons to set the value for each part.

### 5 Save your MIXING CONSOLE settings.

**To save the PANEL PART display settings:** Register them to Registration Memory (page 68).

**To save the STYLE PART display settings:** Save them as Style data.

- 1 Call up the operation display.  
[DIGITAL RECORDING] → [B] STYLE CREATOR
- 2 Press the [EXIT] button to close the RECORD display.
- 3 Press the [I] (SAVE) button to call up the Style Selection display for saving your data, then save it.

**To save the SONG CH 1-8/9-16 display settings:** First register the edited settings as part of the Song data (SETUP), then save the Song.

- 1 Call up the operation display.  
[DIGITAL RECORDING] → [A] SONG CREATOR
- 2 Use the TAB [◀][▶] buttons to select the CHANNEL Page.
- 3 Use the [A]/[B] buttons to select “SETUP”.
- 4 Press the [D] (EXECUTE) button.
- 5 Press the [I] button to save the song to the User drive or external devices.



# Master Compressor

Compressor is an effect commonly used to limit and compress the dynamics (softness/loudness) of an audio signal. For signals that vary widely in dynamics, such as vocals and guitar parts, it “squeezes” the dynamic range, effectively making soft sounds louder and loud sounds softer. When used with gain to boost the overall level, this creates a more powerful, more consistently high-level sound.

## Editing Master Compressor Settings

Select the [CMP] tab in step 2 on page 78.

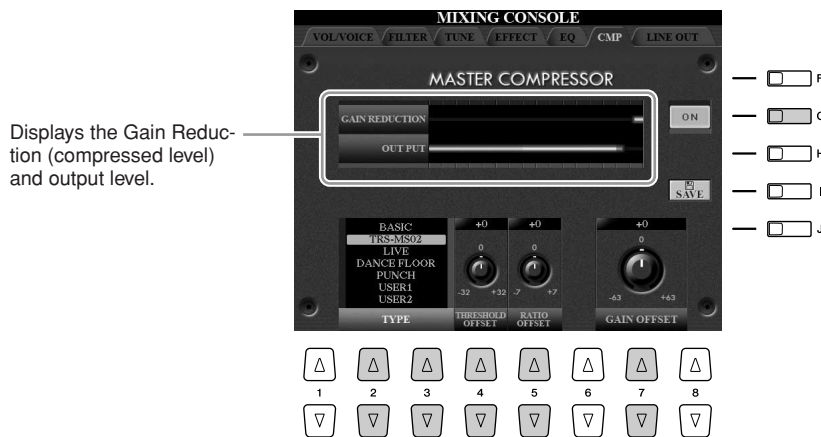

[G]	ON/OFF	Turns the Master Compressor effect on or off.
[2 ▲▼]/ [3 ▲▼]	TYPE	Selects a Master Compressor type.  <b>NOTE</b> By default, the type is set to “TRS-MS02” (the most appropriate setting for use with the optional TRS-MS02 speaker system).
[4 ▲▼]	THRESHOLD OFFSET	Determines the threshold (minimum level at which compression starts).
[5 ▲▼]	RATIO OFFSET	Determines the ratio of compression (how much the dynamic range is compressed).
[7 ▲▼]	GAIN OFFSET	Determines the output level.



# Saving Master Compressor Settings

The Master Compressor settings you have edited on page 80 can be saved as the User Compressor type.

- 1 Press the [I] (SAVE) button to enter the USER MASTER COMPRESSOR display.

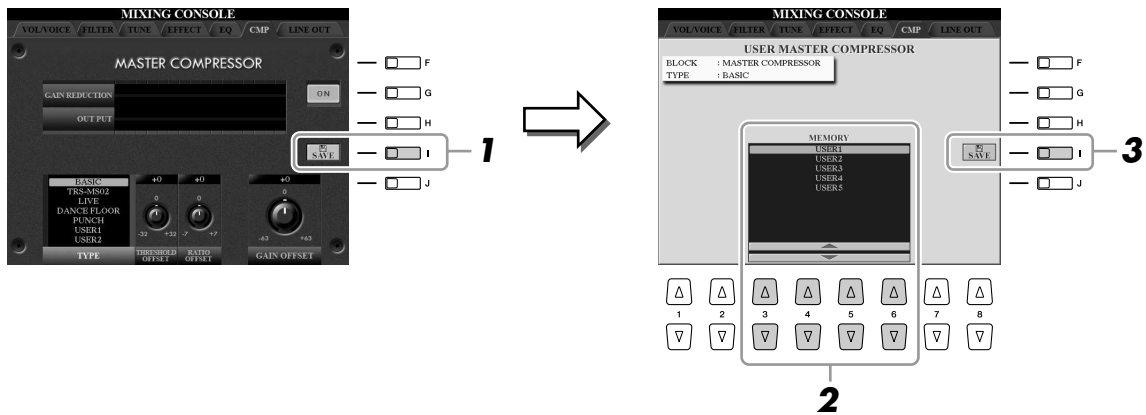

- 2 Select the destination to which the User Master compressor is to be stored, by using the [3 ▲▼]–[6 ▲▼] buttons.
- 3 Press the [I] (SAVE) button to open the SAVE display.
- 4 Enter the name of the edited Compressor type (page 34), then press the [8 ▲] (OK) button.
- 5 Press the [EXIT] button to return to the previous display.

The saved Compressor type is shown in the TYPE selection at the bottom left of the display.

Advanced Features	Refer to the Reference Manual on the website.
Editing VOL/VOICE parameters:	MIXING CONSOLE display → TAB [◀ ▶] VOL/VOICE
Editing FILTER parameters:	MIXING CONSOLE display → TAB [◀ ▶] FILTER
Editing TUNE parameters:	MIXING CONSOLE display → TAB [◀ ▶] TUNE
Editing EFFECT parameters:	MIXING CONSOLE display → TAB [◀ ▶] EFFECT
Editing EQ parameters:	MIXING CONSOLE display → TAB [◀ ▶] EQ
LINE OUT Settings:	MIXING CONSOLE display → TAB [◀ ▶] LINE OUT



# Internet Direct Connection

## – Connecting the Tyros3 Directly to the Internet –

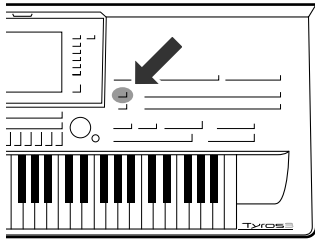

You can purchase and download Song data and other types of data from the special website by directly connecting to the Internet.

### Connecting the Instrument to the Internet

You can connect the instrument to a full-time online connection (ADSL, optical fiber, cable Internet, etc.) via a router or a modem equipped with a router. For specific instructions on connecting (as well as information on compatible LAN adaptors, routers, etc.), refer to the Yamaha website (<http://music.yamaha.com/idc/>).

Use a computer to connect to the Internet and get online before connecting the instrument, since no modem or router settings can be made from the instrument itself.

To use the Internet connection, you will first need to subscribe to an Internet service or provider.

#### ● Connection example 1:

Connecting by cable (using a modem without router)

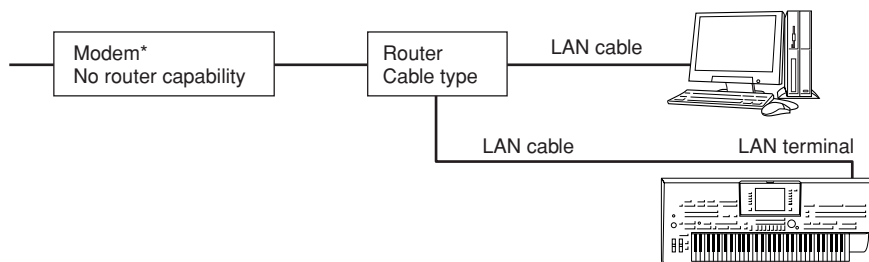

\* Here, "modem" refers to an ADSL modem, optical network unit (ONU) or cable modem.

#### ● Connection example 2:

Connecting by cable (using a modem with router)

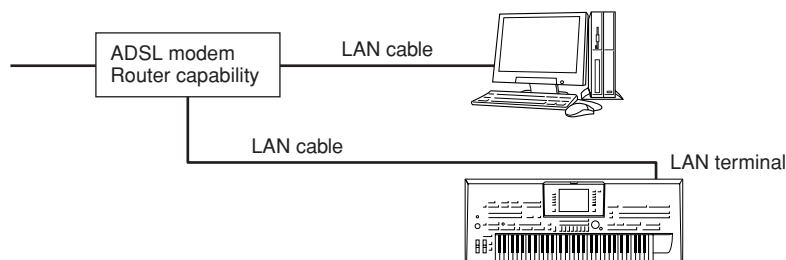

#### NOTE

Depending on the Internet connection, you may not be able to connect to two or more devices (for example, a computer and the instrument), depending on the contract with the provider. This means you cannot connect with the Tyros3. If in doubt, check your contract or contact your provider.

#### IMPORTANT

Due to EU/Korea regulations, users within Europe and Korea should use an STP (shielded twisted pair) cable to prevent electromagnetic interference.

#### NOTE

Some types of modems require an optional hub network for simultaneously connecting to several devices (such as computer, musical instrument, etc.).

● **Connection example 3: Wireless connection**  
**Using a wireless LAN Adaptor**

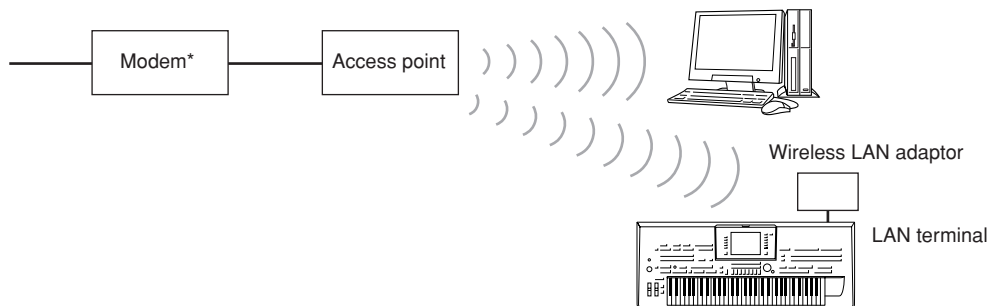

\* Here, "modem" refers to an ADSL modem, optical network unit (ONU) or cable modem.

● **Connection example 4: Wireless connection**  
**Using a USB wireless LAN adaptor**

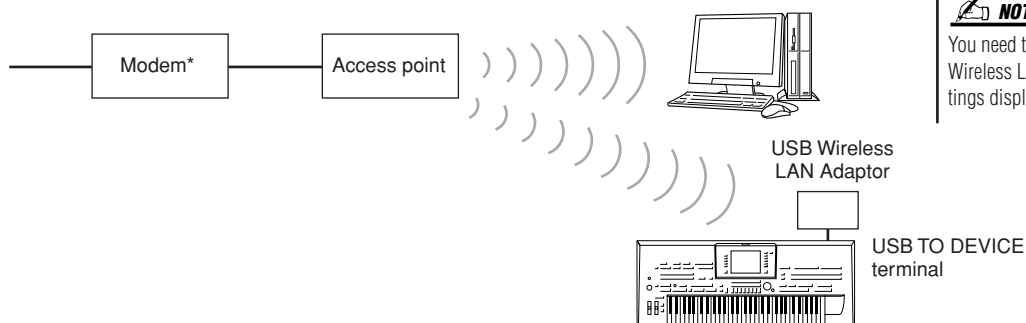

**NOTE**  
 You need to make some settings in the Wireless LAN Page of the Internet Settings display (page 86).

\* Here, "modem" refers to an ADSL modem, optical network unit (ONU) or cable modem.

**Accessing the Special Website**

From the special website, you can audition and purchase Song data, among other things. To access the site, press the [INTERNET] button while the instrument is connected to the Internet.

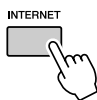

To close the website display and return to the operation display of the instrument, press the [EXIT] button.

## Operations in the Special Website

By using the [1 ▲▼]–[8 ▲▼] buttons, you can navigate through the website—e.g., follow links, return to previously displayed pages, etc.

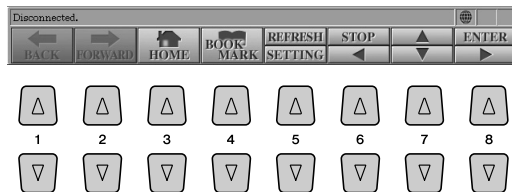

[1 ▲▼]	BACK	Returns to a previously selected web page.
[2 ▲▼]	FORWARD	Returns to the page selected before pressing the [1 ▲▼] (BACK) button
[3 ▲▼]	HOME	Returns to the Home Page (top page of the special website).
[4 ▲▼]	BOOKMARK	Opens the Bookmark display to register the currently displayed page to bookmark. In the Bookmark display, you can edit your bookmarks. For details, see the Reference Manual.
[5 ▲]	REFRESH	Refreshes a web page. This lets you confirm the latest version of the page by reloading the page.
[5 ▼]	SETTING	Opens the Internet Setting display. See page 85.
[6 ▲]	STOP	Cancels loading of a page, if the page is taking too long to open.
[6 ▼]/ [7 ▲▼]/ [8 ▼]		Selects the links in the displayed page. After selecting the desired link, press the [8 ▲] (ENTER) button to actually call up the link destination.  <b>NOTE</b> You can also use the [DATA ENTRY] dial and the [ENTER] button to select and call up links.
[8 ▲]	ENTER	Calls up the link destination.

When the size of the web page is too large to be shown at one time in the browser display of the instrument, a scroll bar appears at the right side of the display. Use the [DATA ENTRY] dial to scroll through the display and view those parts of the page that are not shown.

### Monitoring the Internet Connection Status

The messages and icons at the bottom right of the Internet display indicate the current Internet connection status.



The following three messages are displayed according to the loading status of the web page.

- **Disconnected.:** This appears when the instrument is not connected with the Internet. When this message is displayed, the web page cannot be seen. Icon ① is displayed.
- **Now opening web page...:** The web page is being loaded. Icon ② flashes.
- **Web page has been displayed.:** Loading of the web page is completed, and the page is displayed completely. Icon ② stops flashing. When the displayed web page uses SSL, icon ③ is displayed, and information is encrypted for communication.

Strength of the reception is displayed in ④ when connecting to the Internet by wireless LAN. When reception is weak, move the instrument near the access point to improve reception.

**NOTE**

SSL (Secure Sockets Layer) is an industry-standard method for protecting web communications by using data encryption and other tools.

## Purchasing and Downloading Data

You can purchase and download Song data (for playback on this instrument) and other types of data from the special website. For details on purchasing and downloading data, refer to the instructions on the site itself.

### Operation after purchase and download

When downloading is completed, a message appears asking you whether or not to open the File Selection display. Select “YES” to call up the File Selection display, from which you can select the downloaded data. To return to the Internet display, select “NO.” When the File Selection display is open, press the [8 ▲] (UP) button to call up the next highest level folder.

#### ⚠ CAUTION

The purchased data will be lost if you turn the power to the instrument off during download.

#### Download Destination

When a USB storage device is connected to the instrument during purchase, the downloaded data is saved in the “MyDownloads” folder in the USB tab display of the File Selection display.

When a USB storage device is not connected, the downloaded data is saved in the “MyDownloads” folder in the USER tab display of the File Selection display.

## About the Internet Settings Display

From the Internet Settings display, you can make various settings related to the Internet connection, including preferences for the menus and displays.

- 1 Press the [5 ▼] (SETTING) button to call up the Internet Settings display.

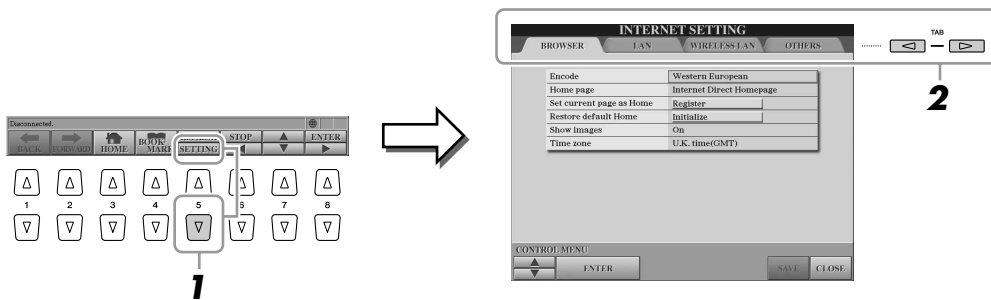

- 2 Press the TAB [◀|▶] buttons to select the desired display.

- **BROWSER**..... Basic settings for browser. Refer to the Reference Manual.
- **LAN**..... Settings for the LAN connection (page 86).
- **WIRELESS LAN**... Settings for the wireless LAN connections (page 86).
- **OTHERS**..... Proxy settings (page 86), initializing menu (page 87) and connection information (page 86).

- 3 Select the desired item by pressing the [1 ▲▼] (UP/DOWN) buttons.

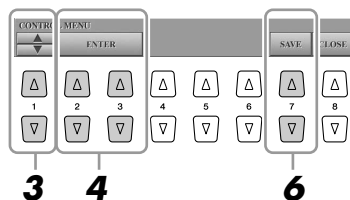

**4 To call up the relevant Edit display, use the [2 ▲▼]/[3 ▲▼] (ENTER) buttons.**

For some items, the Edit display may not be shown, but the setting or change may be executed.

**5 Press the [2 ▲▼] (UP/DOWN) buttons to select the setting or change the value, then press the [3 ▲] (OK) button.**

This can also be done by using the [DATA ENTRY] dial and the [ENTER] button.

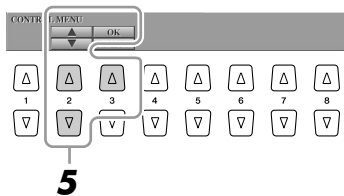

**6 To actually apply all settings changed in the Internet Settings display, press the [7 ▲▼] (SAVE) button.**

To cancel, press the [8 ▲▼] (CLOSE) button.

## Connection-Related Settings

Depending on your connection environment, you may need to make the following settings for connecting to the Internet.

● **LAN Page**

The settings here are necessary when the DHCP is not used. These settings are necessary not only for cable LAN connection but also wireless LAN connection.

Use DHCP	Determines whether or not DHCP is used.
DNS server 1/2	Determine the addresses of primary and secondary DNS servers. These settings must be made when “Use DHCP” above is set to “ON (set DNS manually)” or “OFF.”
IP address/Subnet mask/ Gateway	Determine IP address, subnet mask and gateway server address. These settings must be made when “Use DHCP” above is set to “OFF.”

● **Wireless LAN Page**

The settings here are necessary only when using a USB wireless LAN adaptor. Make sure to set them to the same settings as that of the Access Point.

Wireless networks	Calls up the access point list. Select the desired access point by using the [B]/[C] buttons and press the [G] (OK) button.
SSID	Determines the SSID setting. (SSID is an identification name for specifying a particular network over a wireless LAN connection.)
Channel	Determines the channel.
Encryption	Determines whether or not the data is encrypted.
WEP key	Determines the WEP key. This setting must be made when Encryption above is enabled.

● **Others Page**

Proxy settings are necessary only when using a proxy server.

Proxy server/Proxy port/ Non-proxy server	Determines the proxy server name, port number and host name for non-proxy server.
--	---

After entering all necessary settings, you can check detailed information on the current connection by selecting the “Connect Information” menu on the OTHERS Page.

## Initializing Internet Settings

The settings of the Internet function are not initialized when using the Initialize operation of the instrument (page 35); Internet settings must be initialized separately, as explained here. Initializing will reset to the default values not only the settings of the browser, but also all settings you have made in the Internet Settings displays (except for the cookies and bookmarks), including those related to Internet connection.

- 1** Select the **OTHERS** tab in step 2 on page 85.
- 2** Press the [1 ▲▼] (UP/DOWN) buttons to select “Initialize setup.”

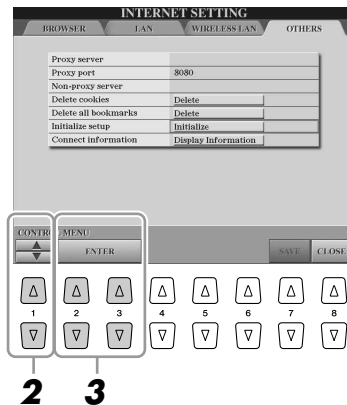

- 3** Use the [2 ▲▼]/ [3 ▲▼] (ENTER) buttons to initialize the Internet settings.

### NOTE

Cookies and bookmarks still remain after executing this initialize operation. To delete the cookies or bookmarks, select “Delete cookies” or “Delete all bookmarks” in step 2.

### Advanced Features

Refer to the Reference Manual on the website.

Registering bookmarks of your favorite pages: Browser display → [4 ▲▼] (BOOKMARK) → [3 ▲▼] (ADD)

Editing bookmarks: Browser display → [4 ▲▼] (BOOKMARK)

# Connections

## – Using Tyros3 with Other Devices –

### **CAUTION**

Before connecting the instrument to other electronic components, turn off the power of all components. Also, before turning any components on or off, make sure to set all volume levels to minimum (0). Otherwise, electrical shock or damage to the components may occur.

## Connecting Audio Devices

### **IMPORTANT**

Since the Tyros3 has no built-in speakers, you need to monitor its sound output via external audio equipment. Alternatively, you could use a pair of headphones (page 15).

## Connecting the Optional Yamaha TRS-MS02 Speaker

Use the [TO RIGHT SPEAKER], [TO LEFT SPEAKER] and [TO SUB WOOFER L/R] jacks. See page 100.

## Using External Audio Devices for Playback

The [LINE OUT] jacks are used to send the Tyros3 output to a keyboard amplifier, stereo sound system, mixing console, or tape recorder. If you are connecting the Tyros3 to a mono sound system, use only the [L/L+R] jack. When only this jack is connected (using a standard phone plug), the left and right channels are combined and output through this jack—allowing you have a mono mix of the Tyros3's stereo sound.

### **NOTE**

You can send a specific part to desired LINE OUT jack(s). The operation display can be called up: [MIXING CONSOLE] → TAB [◀|▶] LINE OUT. For details, refer to the Reference Manual on the website.

### **NOTE**

You can also use the [AUX OUT/LOOP SEND] jacks instead [LINE OUT] jacks. However, the output volume from [AUX OUT/LOOP SEND] cannot be controlled by MASTER VOLUME.

### **CAUTION**

When the Tyros3's sound is output to an external device, first turn on the power to the Tyros3, then to the external device. Reverse this order when you turn the power off.

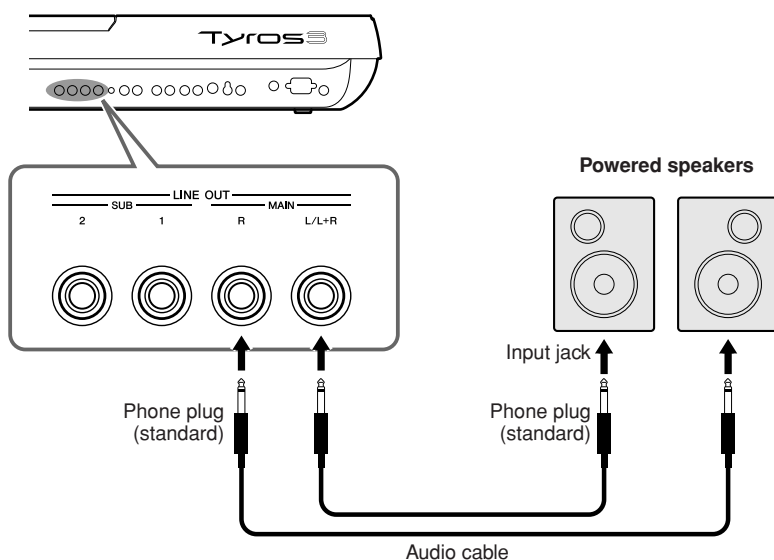



# Mixing the Sound of External Audio Devices with the Tyros3 Sound

The [LINE IN/MIC] jacks can be used either as LINE IN or MIC. The [L/L+R/MIC] jack can be connected to any standard microphone or line-level source with a 1/4" phone plug. By connecting an external audio source to the [R] and [L/L+R/MIC] jacks, you can record that source along with your performance, using the Hard Disk Recorder function. Connecting a source only to the [L/L+R/MIC] jack results in a mono input. Connecting to both the [R] and [L/L+R/MIC] jacks (or only the [R] jack) results in a stereo input. The TRIM control allows the input sensitivity of the MIC/LINE IN jacks to be adjusted for optimum level matching with the connected equipment.

**NOTE**

If you want to connect a Microphone or guitar to the [LINE IN/MIC] jack, refer to page 91.

**CAUTION**

When the sound of an external device is output to the Tyros3, first turn on the power to the external device, then to the Tyros3. Reverse this order when you turn the power off.

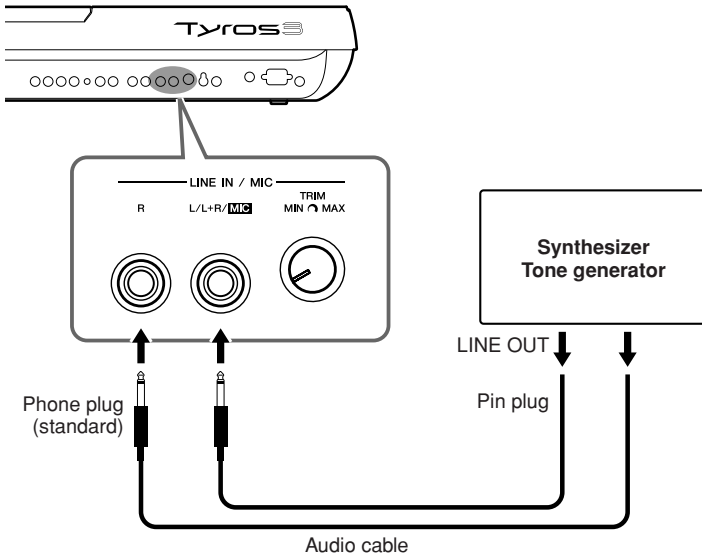

**[AUX IN/LOOP RETURN] and [AUX OUT/LOOP SEND] jacks**

The [AUX OUT/LOOP SEND] jacks can be used either as AUX OUT or LOOP SEND, and can be selected from the Function menu: [FUNCTION] → [I] UTILITY → TAB [◀▶] CONFIG 2. The sound is output at a fixed level, regardless of the [MASTER VOLUME] control setting. Use the [AUX OUT] jacks to output the Tyros3 sound through an external audio system, or to record the sound with an external audio recorder. Connect the [AUX OUT] jacks of the Tyros3 to the [AUX IN] jacks of the audio system using appropriate audio cables. When these are used as LOOP SEND jacks, you can route the output of the Tyros3 to an external signal processor, and return the processed signal back to the instrument via the [AUX IN/LOOP RETURN] jacks—letting you apply your own favorite effects to the overall sound. The TRIM control allows the input sensitivity of the AUX IN [L/L+R] and [R] (LOOP RETURN) jacks to be adjusted for optimum level matching with the connected equipment.

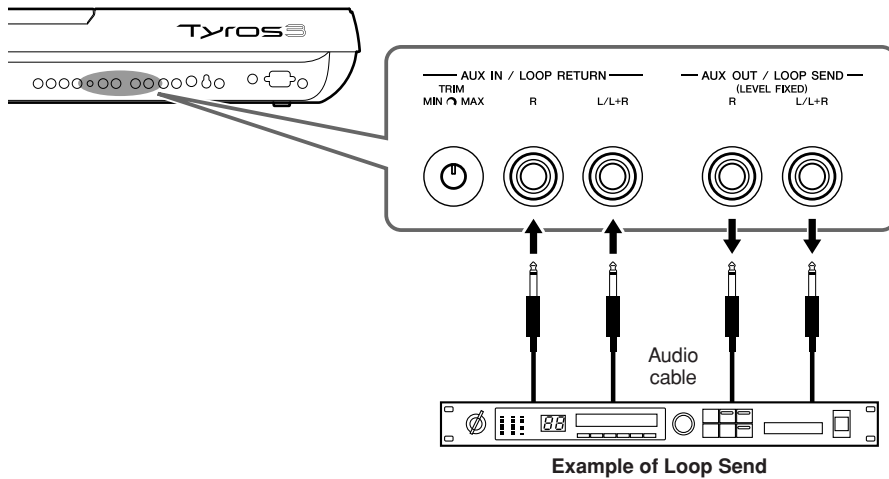

Example of Loop Send

## Connecting a Separate TV Monitor/Computer Monitor

You can connect the Tyros3 directly to an external monitor for displaying the lyrics and chords of your song data on a large screen. There are two kinds of output connectors: RGB OUT (for a computer monitor) and VIDEO OUT (for a TV or video monitor). The RGB OUT terminal delivers higher resolution than the VIDEO OUT jack.

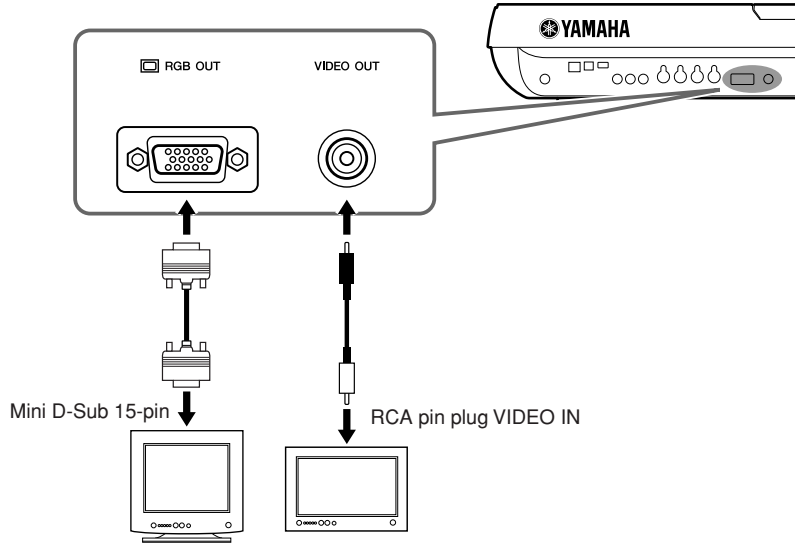

**NOTE**

If the display is not aligned properly in the computer monitor, change the settings on the monitor itself.

**NOTE**

Avoid looking at the monitor for prolonged periods of time since doing so could damage your eyesight. Take frequent breaks and focus your eyes on distant objects to avoid eyestrain.

### Screen Out Settings

- 1** Call up the operation display.  
[FUNCTION] → [G] SCREEN OUT
- 2** Set the monitor type and screen contents.

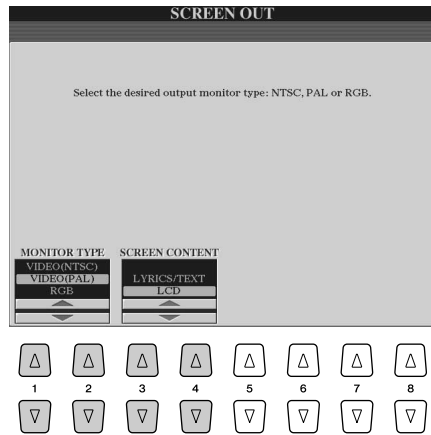

<p>[1 ▲▼]/ [2 ▲▼]</p>	<p>MONITOR TYPE</p>	<p>Selects the desired output monitor type. If you select VIDEO, set the NTSC or PAL to correspond to the standard used by your video equipment.</p> <p><b>NOTE</b></p> <p>The Tyros3's default setting for the external television/video monitor signal is "PAL" Depending on your particular locale, the standard may be different and the setting should be changed accordingly. (For example, NTSC is generally used in North America.) Check the standard used by your television or video monitor, and if it is not PAL, change the setting in the VIDEO OUT display to "NTSC."</p>
<p>[3 ▲▼]/ [4 ▲▼]</p>	<p>SCREEN CONTENT</p>	<p>Determines the contents of the Video Out signal.</p> <ul style="list-style-type: none"> <li>• <b>LYRICS/TEXT:</b> Only the lyrics of the song or text files are output, regardless of the display that is called up on the instrument.</li> <li>• <b>LCD:</b> The currently selected display is output.</li> </ul>

## Connecting a Microphone

By connecting a microphone, you can enjoy singing along with your keyboard performance or with Song playback (KARAOKE). Make sure you have a conventional dynamic microphone.

- 1 Set the [TRIM] control on the rear panel and the [INPUT VOLUME] on the front panel both to “MIN.”

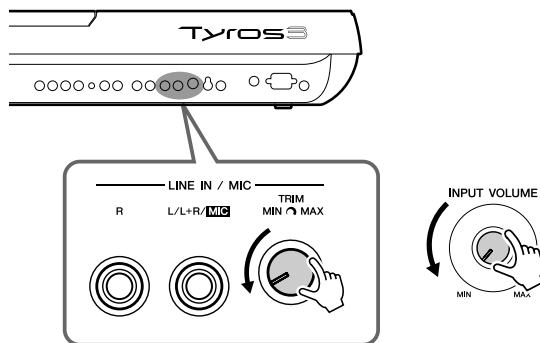

- 2 Connect a microphone to the [L/L+R/MIC] jack.

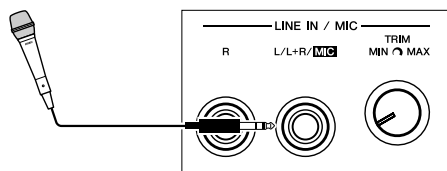

- 3 Turn the power on.

- 4 Adjust the [TRIM] control and [INPUT VOLUME] while singing into the microphone.

Adjust the controls while checking the SIGNAL lamp. Make sure to adjust the controls so the lamp lights in green or orange. Make sure that the lamp does not light in red, since this indicates that the input level is too high.

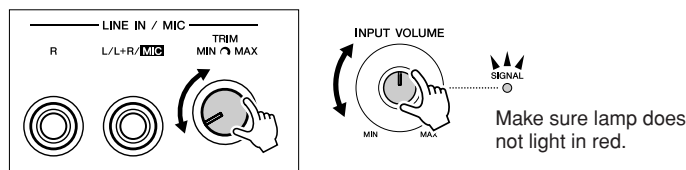

### Disconnecting the microphone

- 1 Set the [TRIM] control and the [INPUT VOLUME] to “MIN.”
- 2 Disconnect the microphone from the Tyros3.

#### **NOTE**

A dynamic microphone with an impedance of 250 ohms is recommended.

#### **NOTE**

You can also connect a guitar to the LINE IN/MIC [L/L+R/MIC] jack in the same way as connecting a microphone.

#### **IMPORTANT**

To avoid producing noise which is picked up from the jack, always set the [INPUT VOLUME] to minimum when nothing is connected to the [L/L+R/MIC] jack.

#### **NOTE**

You may find that microphone sound is distorted even though the SIGNAL lamp does not light in red. If so, try setting the [TRIM] control close to “MIN” and adjusting the [INPUT VOLUME] control until the level is appropriate.

#### **NOTE**

Set the [INPUT VOLUME] to the minimum position before turning off the power.

## Adding Effects to The Microphone Sound

Use the [EFFECT] button to determine the on/off setting of the effect applied to the microphone, set in the Mixing Console display (page 78).

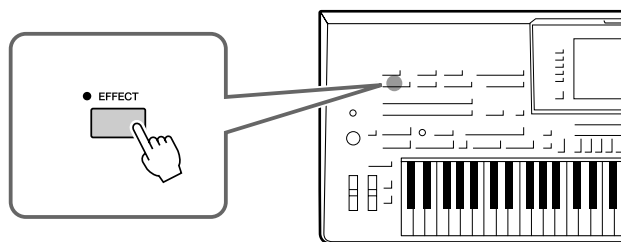

## Applying Harmony Vocals to Your Voice

You can automatically apply various harmony vocals to your voice as you sing into the connected microphone.

- 1 Press the [VOCAL HARMONY] button to turn the function on.

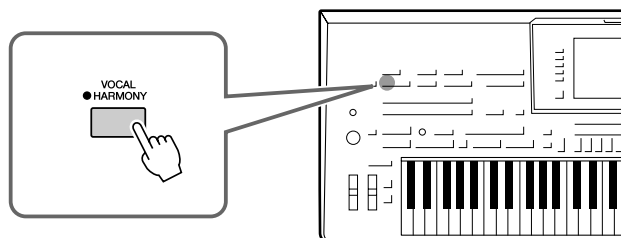

- 2 Press the [VH TYPE SELECT] button to call up the Vocal Harmony Type Selection display.

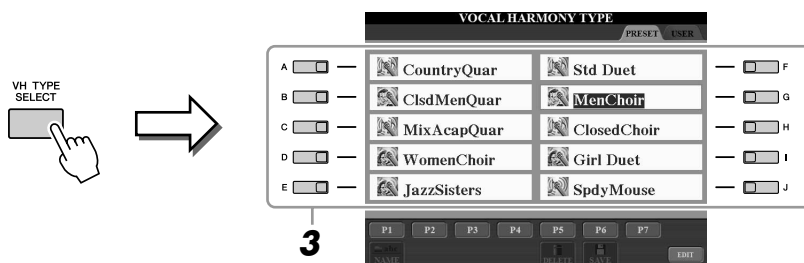

- 3 Select a Vocal Harmony Type by using the [A]–[J] buttons.

To call up the other display pages, press one of the [1 ▲]–[7 ▲] buttons or press the [VH TYPE SELECT] button again.

- 4 Turn the [ACMP] button on.



- 5 Play and hold down chords in the left-hand section of the keyboard as you sing along with the accompaniment.

The harmony is applied to your voice according to the chord you play.



### NOTE

You can adjust the volume balance between the keyboard performance and the microphone by using the [BALANCE] button. Refer to page 55.

### Making announcements between Songs

Turning the [TALK] button on lets you temporarily cancel the vocal harmony or other microphone effects when using a connected microphone. This is especially useful when you talk between songs during a performance.

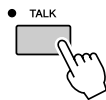

#### Advanced Features

Refer to the Reference Manual on the website.

Microphone overall settings: [MIC SETTING] → TAB [◀▶] OVERALL SETTING

Talk settings: [MIC SETTING] → TAB [◀▶] TALK SETTING

Editing Vocal Harmony: [VH TYPE SELECT] → [8 ▼] (EDIT)

## Connecting Footswitches/Foot Controllers

One or two optional Yamaha FC4 or FC5 footswitches and an optional Yamaha FC7 Foot Controller can be connected to one of these ASSIGNABLE FOOT PEDAL jacks. By default, a foot pedal connected to jack 1 controls sustain, a foot pedal connected to jack 2 controls an articulation effect on a SA/SA2 Voice, and a foot pedal connected to jack 3 controls volume.

**CAUTION**  
Make sure to connect or disconnect the pedal only when the power is off.

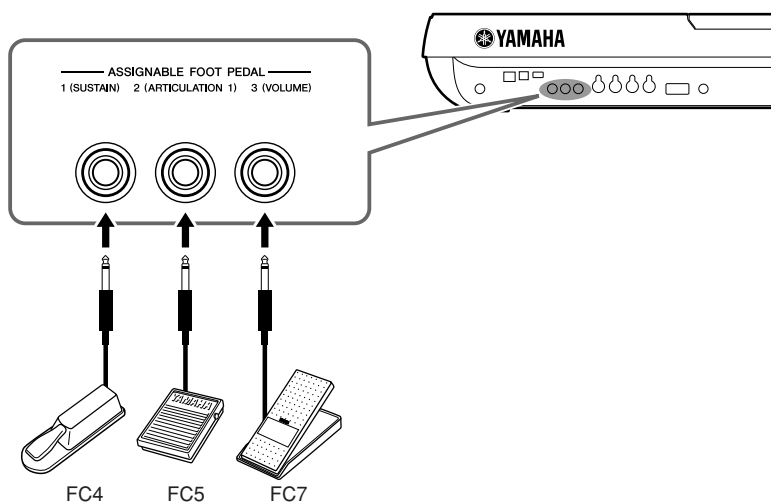

#### Advanced Features

Refer to the Reference Manual on the website.

Assigning specific functions to each foot pedal [FUNCTION] → [D] CONTROLLER → TAB [◀▶] FOOT PEDAL

## Connecting a USB Storage Device

By connecting the instrument to a USB storage device, you can save data you've created to the device, as well as read data from it. Use the [USB TO DEVICE] terminal to connect a USB storage device.

### Precautions when using the [USB TO DEVICE] terminal

This instrument features two built-in [USB TO DEVICE] terminals. When connecting a USB device to the terminal, be sure to handle the USB device with care. Follow the important precautions below.

#### **NOTE**

For more information about the handling of USB devices, refer to the owner's manual of the USB device.

#### ● **Compatible USB devices**

- USB storage devices (flash memory, floppy disk drive, hard disk drive, etc.)
- USB-LAN adaptor
- USB hub

The instrument does not necessarily support all commercially available USB devices. Yamaha cannot guarantee operation of USB devices that you purchase. Before purchasing a USB device for use with this instrument, please visit the following web page: <http://music.yamaha.com/download/>

#### **NOTE**

Other USB devices such as a computer keyboard or mouse cannot be used.

#### ● **Connecting a USB device**

- When connecting a USB device to the [USB TO DEVICE] terminal, make sure that the connector on the device is appropriate and that it is connected in the proper direction.

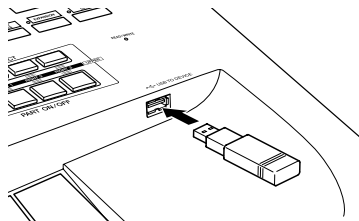

- If you intend to connect two or three devices at the same time to a terminal, you should use a USB hub device. The USB hub must be self-powered (with its own power source) and the power must be on. Only one USB hub can be used. If an error message appears while using the USB hub, disconnect the hub from the instrument, then turn on the power of the instrument and re-connect the USB hub.

#### ● **Using USB Storage Devices**

By connecting the instrument to a USB storage device, you can save data you've created to the connected device, as well as read data from the connected device.

#### **NOTE**

Although CD-R/RW drives can be used to read data to the instrument, they cannot be used for saving data.

#### ● **Number of USB storage devices that can be used**

Up to two USB storage devices can be connected to the [USB TO DEVICE] terminal. (If necessary, use a USB hub. The number of USB storage devices that can be used simultaneously with musical instruments even when a USB hub is used is a maximum of two.)

#### ● **Formatting USB storage media**

When a USB storage device is connected or media is inserted, a message may appear prompting you to format the device/media. If so, execute the Format operation (page 95).

#### ● **Protecting your data (write-protect)**

To prevent important data from being inadvertently erased, apply the write-protect provided with each storage device or media. If you are saving data to the USB storage device, make sure to disable write-protect.

#### ● **Connecting/removing a USB storage device**

Before removing the media from the device, make sure that the instrument is not accessing data (such as in the Save, Copy and Delete operations).

#### **CAUTION**

Avoid frequently turning the power on/off to the USB storage device, or connecting/disconnecting the device too often. Doing so may result in the operation of the instrument "freezing" or hanging up. While the instrument is accessing data (such as during Save, Copy, Delete, Load and Format operations) or is mounting the USB storage device (shortly after the connection), do NOT unplug the USB connector, do NOT remove the media from the device, and do NOT turn the power off to either device. Doing so may corrupt the data on either or both devices.

## Formatting a USB Storage Device

When a USB storage device is connected or media is inserted, a message may appear prompting you to format the device/media. If so, execute the format operation.

### **CAUTION**

The format operation deletes any previously existing data. Make sure that the media you are formatting does not contain important data. Proceed with caution, especially when connecting multiple USB storage medias.

**1** Insert a USB storage device for formatting into the [USB TO DEVICE].

**2** Call up the operation display.

[FUNCTION] → [I] UTILITY → TAB [◀] [▶] MEDIA

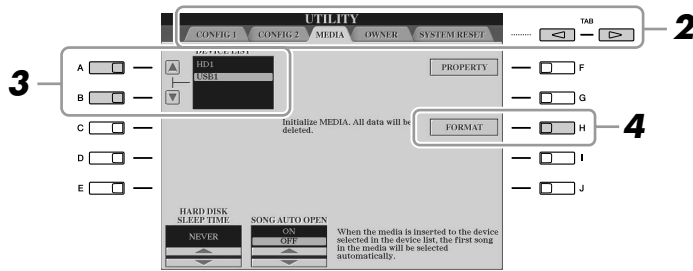

**3** Press the [A]/[B] buttons to select the USB device to be formatted from the device list.

The indications USB 1, USB 2, etc. will be displayed depending on the number of the connected devices.

**4** Press the [H] (FORMAT) button to format the device/media.

## Connecting to a Computer

By connecting a computer to the [USB TO HOST] terminal, you can transfer data between the Tyros3 and the computer via MIDI, and use the computer to control, edit and organize data on the Tyros3. For example, you can use the included Voice Editor program to edit the Tyros3's Custom Voices.

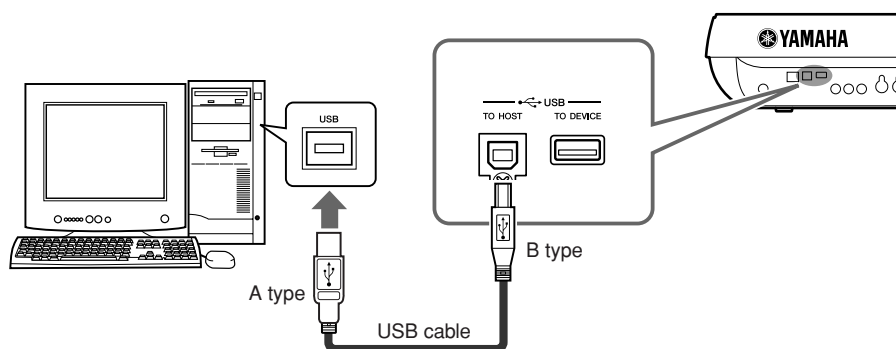

### NOTE

You need to install a USB-MIDI driver to connect the computer and the instrument. Refer to the separate Installation Guide.

### NOTE

You can also use the MIDI IN/OUT terminals to connect to a computer. In this case, a USB-MIDI interface (such as the Yamaha UX16) is needed. For more information, refer to the owner's manual of the USB-MIDI interface.

### Precautions when using the [USB TO HOST] terminal

When connecting the computer to the [USB TO HOST] terminal, make sure to observe the following points. Failing to do so risks freezing the computer and corrupting or losing the data. If the computer or the instrument freezes, restart the application software or the computer OS, or turn the power to the instrument off then on again.

#### CAUTION

- Use an AB type USB cable of less than about 3 meters.
- Before connecting the computer to the [USB TO HOST] terminal, exit from any power-saving mode of the computer (such as suspended, sleep, standby).
- Before turning on the power to the instrument, connect the computer to the [USB TO HOST] terminal.

#### CAUTION

- Execute the following before turning the power to the instrument on/off or plugging/unplugging the USB cable to/from the [USB TO HOST] terminal.
  - Quit any open application software on the computer.
  - Make sure that data is not being transmitted from the instrument. (Data is transmitted only by playing notes on the keyboard or playing back a song.)
- While the computer is connected to the instrument, you should wait for six seconds or more between these operations: (1) when turning the power of the instrument off then on again, or (2) when alternately connecting/disconnecting the USB cable.



# Accessing a Hard Disk Drive on the Tyros3 from the Computer (USB Storage Mode)

When the USB Storage mode is selected, Wave files and Song files can be transferred between the internal hard disk drive of the Tyros3 and the computer. In the “normal” mode the USB connection can be used for MIDI control. The USB interface does not directly handle audio signals.

## NOTE

The USB Storage Mode can be used with Windows XP/Vista.

**1** Confirm that the hard disk drive is installed to the Tyros3 and turn the computer’s power on.

**2** Turn the Tyros3’s power on while holding the [MUSIC FINDER] button.

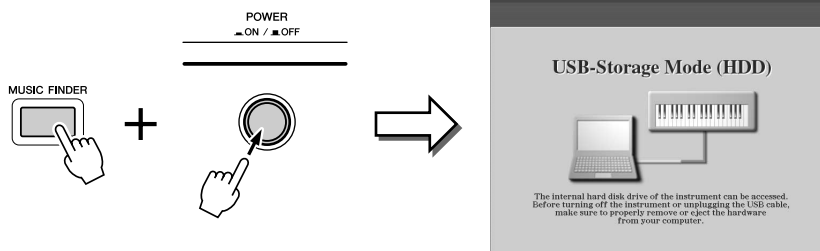

## NOTE

You cannot operate the Tyros3 from the panel while the USB storage mode is engaged. Also, the Tyros3 cannot receive MIDI signals or execute some functions from the pedals while the mode is engaged.

**3** Manage files/folders in the hard disk drive installed to the Tyros3 by using the computer.

**4** Press the [EXIT] button to exit the USB storage mode and call up the Main display.

## NOTE

Execute the following before turning the USB Storage mode on/ off.

- Close all application programs.
- If the USB Storage mode is off, make sure that data is not being transmitted from the Tyros3.
- If the USB Storage mode is engaged, make sure that no file reading or writing operation is in progress.
- If the USB Storage mode is engaged, safely remove the Tyros3 from the Windows taskbar or drag the Tyros3 icons from the Macintosh desktop to the trash after closing all Tyros3 windows.

## CAUTION

**Do not format the hard disk drive from a computer when accessing the drive via the USB storage mode. If you format the hard disk drive while accessing the USB storage mode, the drive may not be able to be used in the Hard Disk Recorder.**

## CAUTION

**Do not access the HDR ROOT folder containing the audio files that you have created with the Hard Disk Recorder function. If you access the folder or make changes to it (moving the folder or copying some files in the folder, etc.), your important data will be deleted or damaged.**

## Connecting External MIDI Devices

The sophisticated MIDI functions give you powerful tools to expand your music performance and creation possibilities. Use the [MIDI] terminals and standard MIDI cables to connect external MIDI devices (keyboard, sequencer, etc.)

- **MIDI IN** ..... Receives MIDI messages from another MIDI device. Two ports (A, B) are provided and each can receive MIDI messages of 16 channels.
- **MIDI OUT** ..... Transmits MIDI messages generated by the Tyros3 to another MIDI device. Two ports (A, B) are provided and each can transmit MIDI messages of 16 channels.

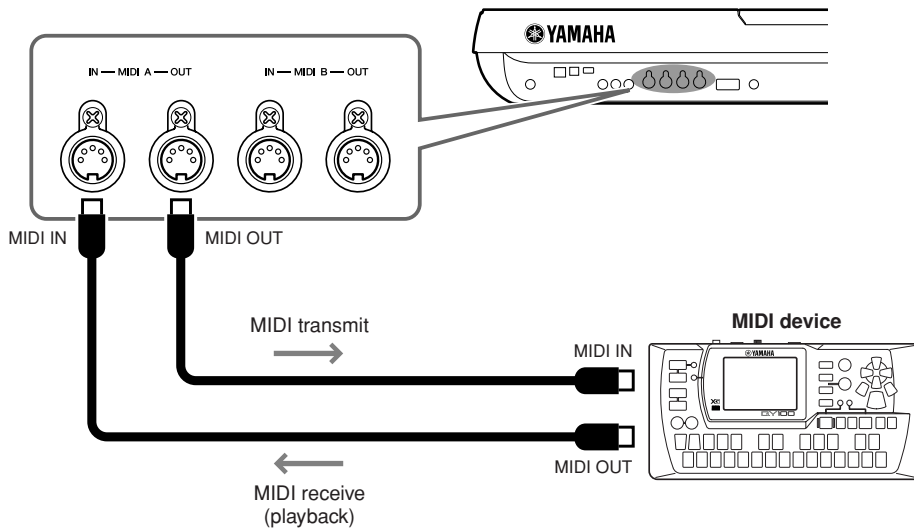

### Advanced Features

Refer to the Reference Manual on the website.

MIDI settings:

[FUNCTION] → [H] MIDI → [8 ▼] EDIT

# Utility

## – Making Global Settings –

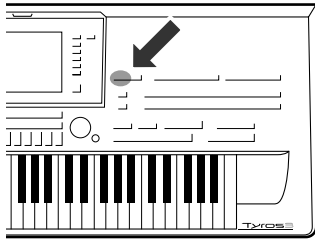

The Utility section in the Function menu provides a variety of convenient tools and settings for the Tyros3. These include general settings that affect the entire instrument, as well as detailed settings for specific functions. Also included are data reset functions and storage media control, such as disk formatting.

To call up the Utility menu, press: [FUNCTION] → [I] UTILITY button.

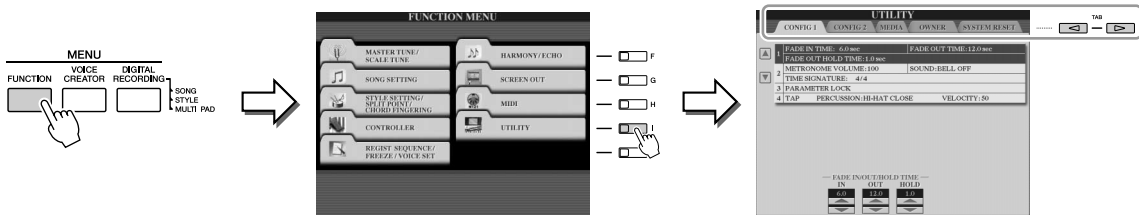

The Utility menu contains the following five pages.

- **CONFIG1** ..... General settings such as Fade in/out time, Metronome sound, Tap Tempo sound, etc.
- **CONFIG2** ..... General settings such as speaker output, pop-up display time, etc.
- **MEDIA** ..... Settings related to installed media (hard disk drive or USB storage device). You can format the media in this page (page 95).
- **OWNER** ..... Settings of Owner name (page 18), Message language (page 17) and background of the Main display. Parameter setting backup/restore operations (page 35) and server authentication can also be done in this page.
- **SYSTEM RESET**... Resets the settings of the instrument.

For details of the Utility settings, refer to the Reference Manual on the website.

# Installing the Optional Speakers

Make sure that you have all of the parts below, included in the TRS-MS02 speaker package.

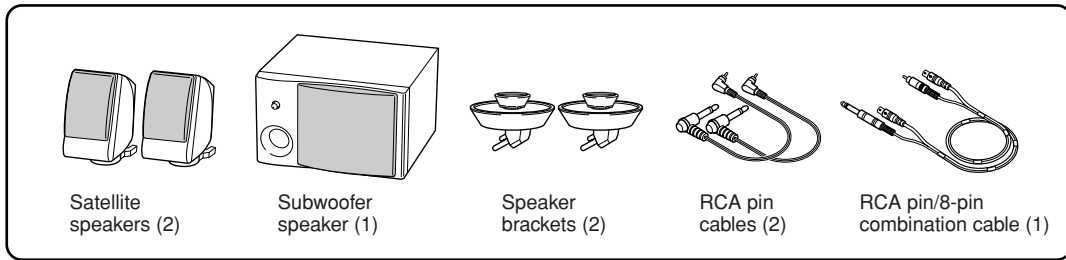

**1** Turn the Tyros3's power off, and disconnect the AC power cord. Also, make sure to disconnect the keyboard from any other external devices.

**2** Insert the two speaker brackets to the rear panel of the Tyros3.

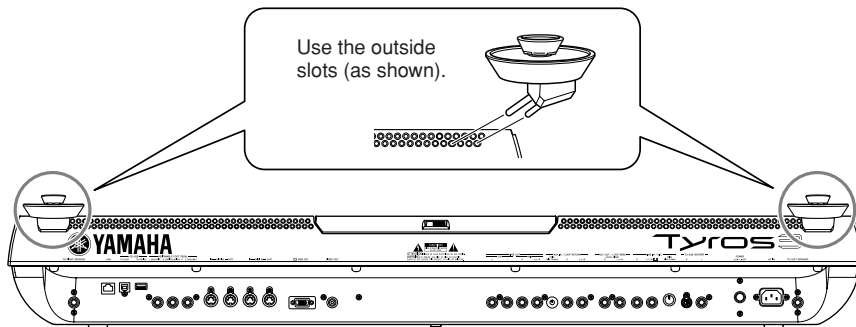

**NOTE**

Either bracket can be fastened to either location.

**3** Fasten the satellite speakers to the left and right brackets.

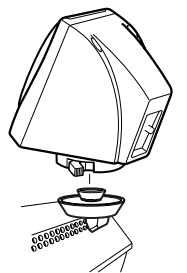

Place the speaker on the bracket.

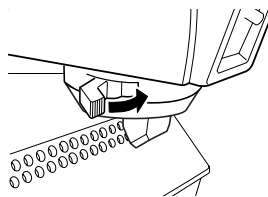

Adjust the direction of the speaker as desired, then fasten it securely to the bracket.

**NOTE**

Either speaker can be placed on either bracket.

**NOTE**

If you want to change the direction of the satellite speaker, unfasten it from the bracket by rotating the lever, then adjust the speaker position as desired, and fasten it to the bracket again.

**4** Use the RCA pin cables to connect the speakers to the respective outputs on the Tyros3.

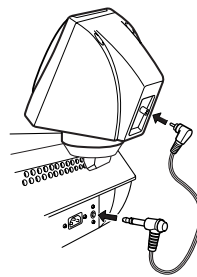
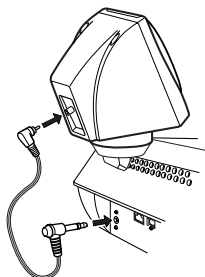

**NOTE**

Either cable can be used for either location.

- 5** Use the RCA pin/8-pin combination cable to connect the subwoofer speaker to the respective outputs on the Tyros3.

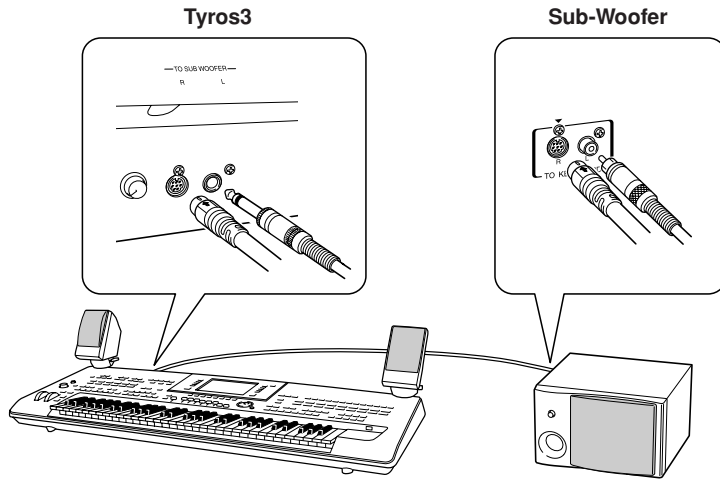

- 6** Connect the power plugs of the Tyros3 and the subwoofer to an appropriate AC outlet.
- 7** First, set the volume controls (**MASTER VOLUME** on the Tyros3 and **BASS** on the subwoofer) to minimum. Finally, turn on the power of the subwoofer, then the Tyros3.

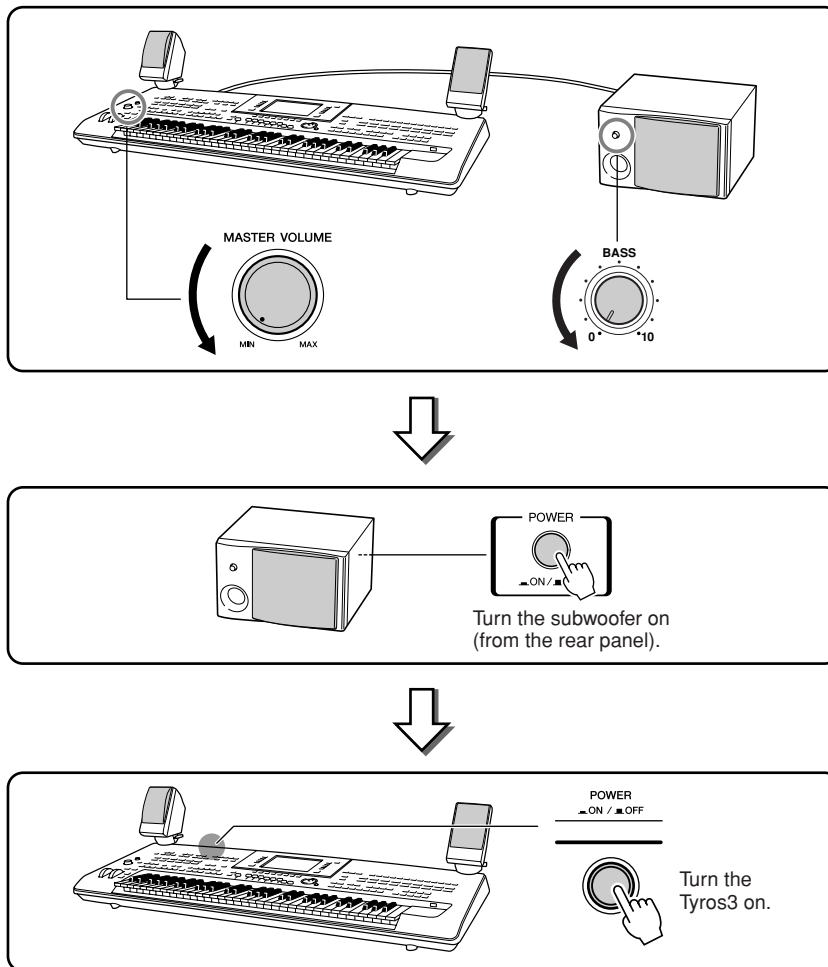

- 8** Adjust the volume controls (**MASTER VOLUME** on the Tyros3 and **BASS** on the subwoofer) to appropriate levels.

# Installing the Optional DIMMs

Installing optional DIMMs to the Tyros3 allows you to save large amounts of Voice data created by the Voice Creator function. This section explains how to install DIMM memory modules to the Tyros3.

## **⚠ WARNING**

- Before beginning installation, switch off the power to the Tyros3 and connected peripherals, and unplug them from the power outlet. Then remove all cables connecting the Tyros3 to other devices. (Leaving the power cord connected while working can result in electric shock. Leaving other cables connected can interfere with work.)
- Be careful not to drop any screws inside the instrument during installation (this can be prevented by keeping the optional units and cover away from the instrument while attaching). If this does happen, be sure to remove the screw(s) from inside the unit before turning the power on. Loose screws inside the instrument can cause improper operation or serious damage. If you are unable to retrieve a dropped screw, consult your Yamaha dealer for advice.
- Install the optional units carefully as described in the procedure below. Improper installation can cause shorts which may result in irreparable damage and pose a fire hazard.

## **⚠ CAUTION**

- Do not touch the exposed metal parts in the circuit board. Touching these parts may result in a faulty contact.
- Be careful not to misplace any of the screws since all of them are used.
- Be careful of static electricity. Static electricity discharge can damage the DIMMs or the instrument. Before you handle the DIMMs, to reduce the possibility of static electricity, touch some unpainted metal surface or a ground wire on a device that is grounded.
- Do not use any screws other than what are installed on the instrument.

## Compatible DIMMs

The Tyros3 does not necessarily support all commercially available DIMMs. Yamaha cannot guarantee operation of DIMMs that you purchase. Before purchasing DIMMs, please consult your Yamaha dealer, or an authorized Yamaha distributor (see list at end of the Owner's Manual) for advice, or see the following page:  
<http://music-tyros.com/>

## DIMM Type and DIMM Configuration

- Yamaha recommends that you purchase DIMMs that conform to the JEDEC\* standard. Please be aware, however, that conformance to this standard does not constitute a guarantee that the DIMMs will operate correctly on the Tyros3.  
\* JEDEC (Joint Electron Device Engineering Council) sets standards for terminal configurations within electronic devices.
- Use only 168-pin DIMMs of 64, 128, 256 or 512 MB capacity (synchronized DRAM; PC100 or PC133).
- Use only DIMMs that have a height 38.2 mm or less.
- When installing DIMMs, make sure to install them in a matched pair of the same capacity. You cannot install only one module and leave the second memory socket open. Also make sure each DIMM in the pair is of the same manufacturer and the same type. DIMMs of different makers and configurations may not work together.
- When purchasing DIMMs, make sure that the DIMM design does not utilize more than 18 memory chips per module. (DIMMs comprised of more than 18 chips do not operate correctly on the Tyros3.)

## DIMM Installation

Before following the steps below, make sure you have appropriate DIMMs and a Phillips screwdriver.

### **1 Turn the Tyros3's power off, and disconnect any cables including AC power cord from the keyboard.**

Also make sure to close the LCD panel and disconnect a USB device from the USB TO DEVICE terminal.

### **2 Turn the Tyros3 face down on a blanket or some soft surface, giving you direct access to the bottom of the instrument.**

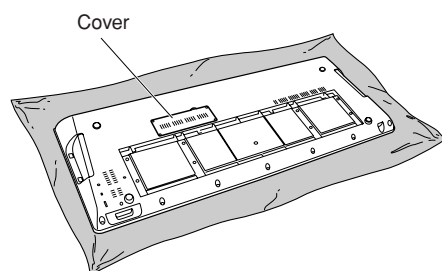

### 3 Remove the four screws from the cover.

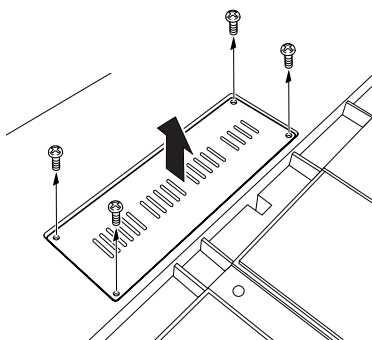

### 4 Insert the two DIMMs into the DIMM sockets.

Open the ejector levers, then insert the DIMM vertically in the socket.

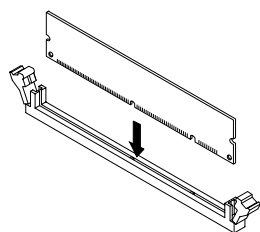
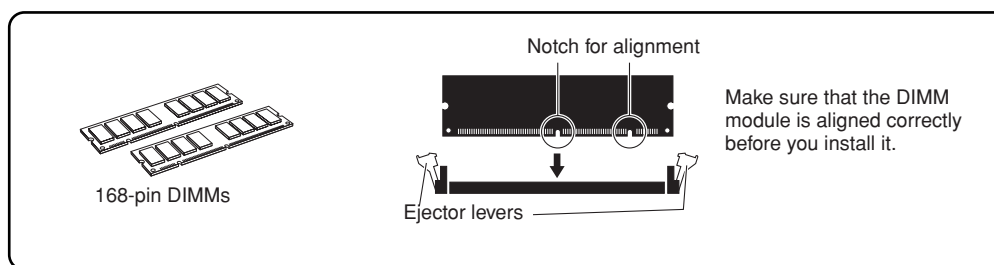

Insert the DIMM vertically in the socket, aligning the notches to the corresponding protrusions.

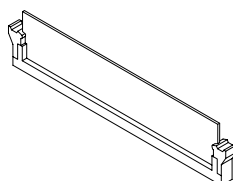

Press it in firmly until it "snaps" or locks in place.

### 5 Re-install the cover you removed in step 3, in reverse order.

### 6 Check that the installed DIMMs are functioning properly.

Set the Tyros3 right-side up, turn the power on and check the WAVE RAM by accessing [VOICE CREATOR] → [B] LIBRARY EDIT → [8 ▼] PROPERTY. If the DIMMs have been installed properly, the appropriate available memory size is indicated in the display.

## Removing DIMMs

Press the ejector levers until the DIMM unlocks.

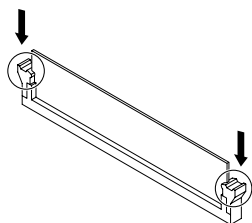

Pull the DIMM vertically out of the socket.

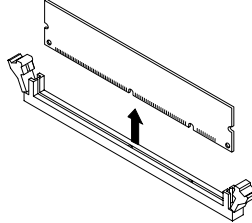

# Replacing the Internal Hard Disk

If the factory-installed hard disk crashes or when you want to replace it with another one (for example, one you have used on the Tyros3/Tyros2), you can remove the current one and install the new one by following the procedure below. The hard disk used must be a 2.5-inch P-ATA (parallel ATA) compatible; however, not all such drives may be installable.

## **WARNING**

- Before beginning, switch off the power to the Tyros3 and connected peripherals, and unplug them from the power outlet. Then remove all cables connecting the Tyros3 to other devices. (Leaving the power cord connected while working can result in electric shock. Leaving other cables connected can interfere with work.)
- Be careful not to drop any screws inside the instrument. If this does happen, be sure to remove the screw(s) from inside the unit before turning the power on. Loose screws inside the instrument can cause improper operation or serious damage. If you are unable to retrieve a dropped screw, consult your Yamaha dealer for advice.
- Install the hard disk units carefully as described in the procedure below. Improper installation can cause shorts which may result in irreparable damage and pose a fire hazard.
- Do not disassemble, modify, or apply excessive force to board areas and connectors on hard disk units. Bending or tampering with boards and connectors may lead to electric shock, fire, or equipment failures.

## **CAUTION**

- Before removing the installed hard disk unit, make sure to backup any necessary data on the disk to computer by using the USB Storage Mode (page 97). This will prevent loss of important data and enable you to use the data on the new hard disk. (If you need to backup the recorded audio files, save the hidden folder "HDR.ROOT" to the computer.)
- It is recommended that you wear gloves to protect your hands from metallic projections on hard disk units and other components. Touching leads or connectors with bare hands may cause finger cuts, and may also result in poor electrical contact or electrostatic damage.
- Handle the hard disk unit with care. Dropping or subjecting them to any kind of shock may cause damage or result in a malfunction.
- Be careful of static electricity. Static electricity discharge can damage the IC chips on the hard disk or the instrument. Before you handle the hard disk, to reduce the possibility of static electricity, touch the metal parts other than the painted area or a ground wire on the devices that are grounded.
- Do not touch the exposed metal parts in the circuit board. Touching these parts may result in a faulty contact.
- Be careful not to misplace any of the screws since all of them are used.
- Do not use any screws other than what are installed on the instrument.

## **NOTE**

- Hard disk drives thicker than 12.7 mm cannot be installed to the Tyros3.
- S-ATA compatible hard disks cannot be used.

Before following the steps below, make sure you have an appropriate hard disk drive and a Phillips screwdriver.

## **1** Turn the Tyros3's power off, disconnect any cables including AC power cord from the keyboard.

Also make sure to close the LCD panel and disconnect a USB device from the USB TO DEVICE terminal.

## **2** Turn the Tyros3 face down on a blanket or some soft surface, giving you direct access to the bottom of the instrument.

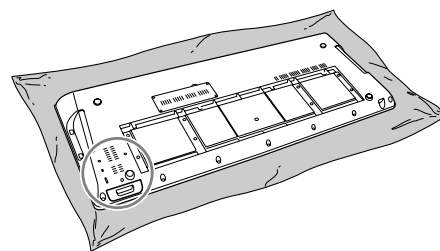

## **3** Remove the three screws.

## **4** Pull out the hard disk bracket.

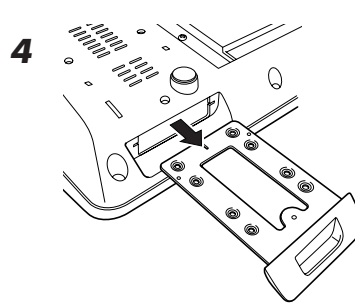
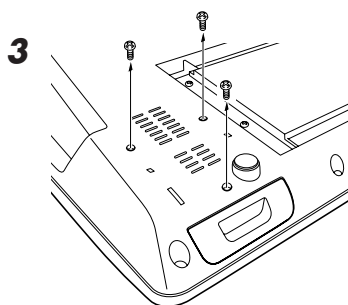



- 5** Remove the four screws to remove the installed hard disk unit from the bracket.

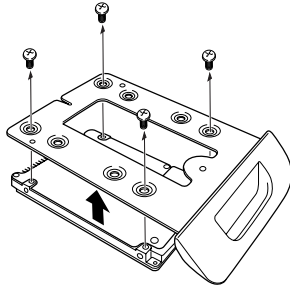

- 6** Attach the new hard disk unit to the bracket using the four screws removed in step 5.

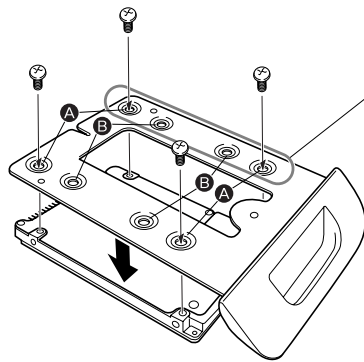

You should tighten these two screws first.

Make sure the bottom of the hard disk is facing up. Depending on the type of hard disk drive you plan to install, select holes **A** or holes **B** to attach the hard disk drive.

\* Holes **A** are used in this illustration.

- 7** Set the Tyros3 right-side up.

- 8** Insert the hard disk bracket into the slot.

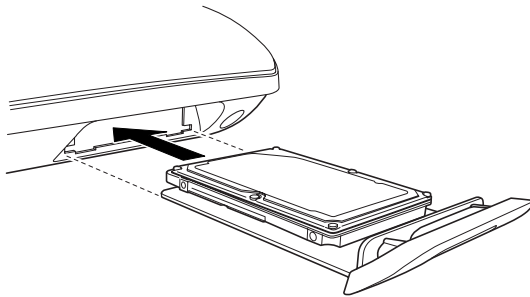

- 9** Turn the Tyros3 face down again and fasten the three screws removed in step 3.

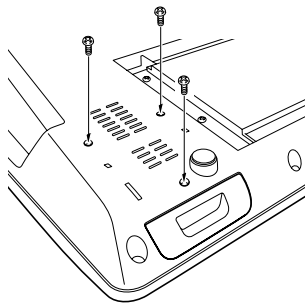

- 10** Check that the installed hard disk is functioning properly.

Set the Tyros3 right-side up, and turn the power on. If the HD tab appears on the File Selection display, the hard disk is OK.

**NOTE**

If you have installed the hard disk that was once used for the Tyros/Tyros2 and turn the Tyros3's power on, you can immediately view the files on the hard disk and use the Song files from the Tyros/Tyros2. However, to properly use the Style, Multi Pad, and Registration Memory files from the Tyros/Tyros2, you will need to convert the data using a computer and the File Converter software (available for free download on the Tyros3 website).

# Troubleshooting

PROBLEM	POSSIBLE CAUSE/SOLUTION
When using a mobile phone, noise is produced.	Using a mobile phone in close proximity to the Tyros3 may produce interference. To prevent this, turn off the mobile phone or use it further away from the Tyros3.
The Main display does not appear even when turning the power on.	This may occur if a hard disk or USB storage device has been installed to the Tyros3. Installation of some hard disk units/USB storage devices may result a long interval between turning the power on and appearance of the Main display.
In the LCD display, there are some black points (unlit) or white points (always lit).	These are the result of defective pixels and occasionally occur in TFT-LCDs; they do not indicate a problem in operation.
The overall volume is too low, or no sound is heard.	<ul style="list-style-type: none"> <li>• The master volume may be set too low. Set it to an appropriate level with the [MASTER VOLUME] dial.</li> <li>• If volume control is assigned to the foot controller or [ASSIGN] slider, set it to an appropriate level.</li> <li>• All keyboard parts are set to off. Use the PART ON/OFF [RIGHT 1]/[RIGHT 2]/[RIGHT 3]/[LEFT] button to turn it on (page 38).</li> <li>• Make sure the desired channel is set to on in the CHANNEL display (pages 54, 63).</li> <li>• The volume of individual parts may be set to low. Raise the volume in the BALANCE display (page 55).</li> <li>• Check whether the external speaker is connected properly (pages 88, 100).</li> <li>• Headphones are connected, disabling the speaker output. Unplug the headphones.</li> <li>• A plug is inserted in the LOOP SEND jacks. Unplug the LOOP SEND jacks.</li> <li>• Is the footswitch connected to the appropriate jack?</li> <li>• The [FADE IN/OUT] button is on, muting the sound. Press the [FADE IN/OUT] button to turn the function off.</li> <li>• Has a Voice been selected from the Expansion Voice Bank? The Expansion Voice Bank is a bank for saving Voices that you have created or obtained via Internet, etc., and is empty by default.</li> </ul>
The sound is distorted or noisy.	<ul style="list-style-type: none"> <li>• The volume may be turned up too high. Make sure all relevant volume settings are appropriate.</li> <li>• This may be caused by the effects. Try cancelling all unnecessary effects, especially distortion-type effects.</li> <li>• Some filter resonance settings in the Voice Set display can result in distorted sound. Adjust these settings if necessary.</li> <li>• Is the gain of the Low band set too high in the EQ Page of the Mixing Console display (page 78)?</li> </ul>
The keyboard volume is lower than the Style/Song playback volume.	<ul style="list-style-type: none"> <li>• The volume of the keyboard parts may be set too low. Raise the volume in the BALANCE display (page 55).</li> <li>• The [ASSIGN] slider may be set to a low level. (By default, keyboard volume is assigned to the [ASSIGN] slider.) Set it to an appropriate level.</li> </ul>
A strange “flanging” or “doubling” sound occurs.	<ul style="list-style-type: none"> <li>• Are the RIGHT 1 and RIGHT 2 parts set to “ON,” and are both parts set to play the same Voice?</li> </ul>
The sound is slightly different each time the keys are played.	<ul style="list-style-type: none"> <li>• If you are routing the MIDI OUT on the Tyros3 to a sequencer and back to the MIDI IN, you may need to set Local Control setting to “off” in the SYSTEM Page of the MIDI display (page 110).</li> </ul>

PROBLEM	POSSIBLE CAUSE/SOLUTION
Not all simultaneously played notes sound.	You are probably exceeding the maximum polyphony of the Tyros3. The Tyros3 can play up to 128 notes at the same time—including RIGHT 1/RIGHT 2/RIGHT 3/LEFT Voices, Style, Song, and Multi Pad notes. When the maximum polyphony is exceeded, the least important notes (such as soft notes and notes currently decaying) will stop sounding first.
Style playback seems to “skip” when the keyboard is played.	
Some characters of the file/folder name are garbled.	The language settings have been changed. Set the appropriate language for the file/folder name (page 17).
An existing file is not shown.	<ul style="list-style-type: none"> <li>• The file extension (.MID, etc.) may have been changed or deleted. Manually rename the file, adding the appropriate extension, on a computer.</li> <li>• Data files with names of more than 50 characters cannot be handled by the instrument. Rename the file, reducing the number of characters to 50 or less.</li> </ul>
When connecting the Tyros3 to a computer, the computer freezes.	An old USB-MIDI driver which is incompatible with the Tyros3 has been installed to the computer. Disconnect the Tyros3 from the computer and uninstall the old driver, then install the latest USB-MIDI driver. The latest driver can be downloaded from Yamaha website ( <a href="http://music.yamaha.com/download">http://music.yamaha.com/download</a> ).
The Voice selected from the Voice Selection display does not sound.	Check whether or not the selected part is turned on (page 38).
When a Voice is changed, the previously selected effect is changed.	Each Voice has its own suitable preset settings, which are automatically recalled when a Voice is selected. To avoid this, turn the Voice Set parameter off in the VOICE SET Page of the REGIST SEQUENCE/FREEZE/VOICE SET display (page 110).
The Voice produces excessive noise.	Certain Voices may produce noise, depending on the Filter (Harmonic Content/Brightness) or EQ settings of the Mixing Console display. This is unavoidable due to the sound generation and processing system of the Tyros3. To avoid noise, try changing the above mentioned settings.
Some Voices jump an octave in pitch when played in the upper or lower registers.	Some Voices have a pitch limit which, when reached, causes this type of pitch shift. This is normal.
The Style does not start even when the [START/STOP] button is pressed.	The Rhythm part of the selected Style may not contain any data. Turn the [ACMP] button on and play the left-hand section on the keyboard to sound the accompaniment part of the Style.
The Style does not start, even when Synchro Start is in standby condition and a key is pressed.	You may be trying to start a Style by playing a key in the right-hand range of the keyboard. When the [ACMP] button is on, you need to play a key in the left-hand (chord) range of the keyboard to start the Style with Synchro Start.
Only the rhythm channel of Style plays.	<ul style="list-style-type: none"> <li>• Make sure that the [ACMP] button is turned on.</li> <li>• You may be playing keys in the right hand range of the keyboard. Make sure to play keys in the chord range of the keyboard.</li> </ul>
Auto accompaniment chords are recognized regardless of the Split Point or where chords are played on the keyboard.	This is normal if the fingering mode is set to “Full Keyboard” or “AI Full Keyboard” in the CHORD FINGERING display (page 110). If either of these is selected, chords are recognized over the entire range of the keyboard, irrespective of the split point setting.
Auto accompaniment chord does not change even when a different chord is played or the chord is not recognized.	<ul style="list-style-type: none"> <li>• Are you sure you’re playing on the left-hand section of the keyboard?</li> <li>• You may be using single-finger type fingering. Change the fingering mode in the CHORD FINGERING display (page 110).</li> </ul>

PROBLEM	POSSIBLE CAUSE/SOLUTION
Song playback does not start.	<p>If the Song is write-protected (“Prot. 2 Edit” is shown at the upper left of the Song name):</p> <ul style="list-style-type: none"> <li>• The original file may not be in the same folder. It cannot be played back unless the original file (showing “Prot.2 Orig” at the upper left of the Song name) is in the same folder.</li> <li>• The original file name may have been changed. Rename the file with the original file name (so that “Prot.2 Orig” is shown at the upper left of the Song name).</li> <li>• The file icon may have been changed. Songs to which write-protect has been applied cannot be played back when the file icon of the original has been changed.</li> </ul>
The vibrato effect applied when a Song is recorded sounds different when it is played back.	<p>This may occur when you use SA2 Voices which have their own default vibrato value. Depending on the Modulation wheel position, the default vibrato value may be recorded or the modulation wheel value may be recorded, regardless of the actual vibrato sound you have played. To remedy this:</p> <ul style="list-style-type: none"> <li>• Select a Voice AFTER you set the Modulation wheel to minimum (down) position.</li> <li>• If you want to cancel the vibrato effect, set the Modulation wheel to minimum position AFTER Song recording starts.</li> </ul>
An audio song cannot be copied or cut.	<p>The audio song file name (which contains the file path, internally) may be too long. Shorten the song name or copy/paste the file to a higher folder level.</p>
In the Hard Disk Recorder function, an error message appears and audio cannot be recorded to the installed hard disk drive.	<p>The data on the hard disk drive is fragmented and cannot be used as is. Since there is no defragmentation function in the Hard Disk Recorder, the drive can only be defragmented by formatting it. To do this, first back up the data to a computer by using the USB storage mode (page 97), then format the drive, and finally copy the data back to the drive (using the USB storage mode again). Performing this copy/restore operation effectively defragments the drive, allowing you to use it again.</p>
The Vocal Harmony effect sounds distorted or out-of-tune.	<p>Your vocal microphone may be picking up extraneous sounds, such as the Style sound from the Tyros3. In particular, bass sounds can cause mistracking of the Vocal Harmony. To remedy this:</p> <ul style="list-style-type: none"> <li>• Sing as closely to the microphone as possible.</li> <li>• Use a directional microphone.</li> <li>• Turn down the Master volume, Style volume, or Song volume control (pages 16, 55).</li> <li>• Separate the microphone from the external speakers as much as possible.</li> <li>• Cut the Low band via the 3 Band EQ function in the MICROPHONE SETTING display (page 109).</li> <li>• Raise the microphone input level (TH) via the Compressor function in the MICROPHONE SETTING display (page 109).</li> </ul>
Appropriate harmony notes are not produced by the Vocal Harmony feature.	<p>Try to change the Vocal Harmony Control setting in the OVERALL SETTING Page of the Microphone Setting display (page 109). Also make sure to use the appropriate method to specify the harmony notes for the selected Vocal Harmony mode. Refer to the Reference Manual.</p>

# Panel Button Chart

- **No.** ..... Corresponds to the number in the “Panel Controls and Terminals” on page 12.
- **Button/Control**..... Indicates the button/controller that you should use at first for entering the corresponding function.
- **Display** ..... Indicates the display title (and tab title) called up by operating the button/controller.
- **Reference Manual** ..... “●” indicates that the detailed information is described in the Reference Manual (downloadable from website).

No.	Button/Control	Display	Page	Reference Manual		
①	INPUT VOLUME control	—	91	—		
②	MASTER VOLUME control	—	16	—		
③	[DEMO]	DEMO display	19	—		
④	[FADE IN/OUT]	—	51	—		
⑤	UPPER OCTAVE [-]/[+]	UPPER OCTAVE (pop-up)	41	—		
⑥	PITCH BEND wheel	—	41	—		
⑦	MODULATION wheel	—	42	—		
⑧	[ART. 1], [ART. 2]	—	42	—		
⑩	MIC	[VH TYPE SELECT]	Vocal Harmony Type Selection display	92	●	
		[MIC SETTING]	MICROPHONE SETTING display	OVERALL SETTING	93	●
			TALK SETTING	93	●	
		[VOCAL HARMONY]	—	92	—	
		[EFFECT]	—	92	—	
	[TALK]	—	93	—		
⑪	SONG	[I]–[IV]	Song Selection display	59	—	
		[SP 1]–[SP 4]	—	62	●	
		[LOOP]	—	63	—	
		[REC]	—	57	—	
		[STOP]	—	57, 59	—	
		[PLAY/PAUSE]	—	60	—	
		[REW]/[FF]	SONG POSITION (pop-up)	60	●	
		[METRONOME]	—	58	—	
	[LYRICS/TEXT]	LYRICS or TEXT display	61	●		
		SCORE display	61	●		
⑫	STYLE	[POP & ROCK]–[WORLD]	Style Selection display	48	—	
		[FILE ACCESS]	—	29	—	
⑬	STYLE CONTROL	[ACMP]	—	48	—	
		[OTS LINK]	—	53	—	
		[AUTO FILL IN]	—	51	—	
		INTRO [I]–[III]	—	50	—	
		MAIN VARIATION [A]–[D]	—	51	—	
		[BREAK]	—	51	—	
		ENDING/rit. [I]–[III]	—	50	—	
		[SYNC STOP]	—	50	—	
		[SYNC START]	—	50	—	
		[START/STOP]	—	50	—	
⑭	TEMPO	[TAP TEMPO]	—	51	—	
		TEMPO [-]/[+]	TEMPO (pop-up)	51	—	
⑮	MULTI PAD CONTROL	[SELECT]	Multi Pad Selection display	64	●	
		[1]–[4]	—	64	—	
		[STOP]	—	64	—	
⑯	TRANSPOSE [-]/[+]	TRANSPOSE (pop-up)	41	—		

No.	Button/Control	Display		Page	Reference Manual
17	[MIXING CONSOLE]	MIXING CONSOLE display	VOL/VOICE	78	●
			FILTER	78	●
			TUNE	41, 78	●
			EFFECT	78	●
			EQ	78	●
			CMP	80	—
			LINE OUT	78	●
18	[CHANNEL ON/OFF]	CHANNEL ON/OFF (pop-up)	STYLE, SONG	54, 63	—
19	[BALANCE]	BALANCE (pop-up)	1/2, 2/2	55, 75	—
20	TAB [◀][▶]	—	—	21	—
	[A]–[J]	—	—	20	—
	[DIRECT ACCESS]	—	—	23	—
	[EXIT]	—	—	22	—
	ASSIGN slider	—	—	21	—
	[1]–[8] sliders	—	—	21	—
	[1 ▲▼]–[8 ▲▼] buttons	—	—	21	—
	[DATA ENTRY] dial	—	—	22	—
21	MENU [FUNCTION]	MASTER TUNE/SCALE TUNE	MASTER TUNE	47	●
			SCALE TUNE	47	●
		SONG SETTING		63	●
		STYLE SETTING/SPLIT POINT/ CHORD FINGERING	STYLE SETTING	56	●
			SPLIT POINT	38, 56	●
			CHORD FINGERING	49, 56	●
		CONTROLLER	ASSIGN SLIDER	21	—
			FOOT PEDAL	93	●
			KEYBOARD/PANEL	42, 47	●
		REGIST SEQUENCE/FREEZE/ VOICE SET	REGISTRATION SEQUENCE	70	●
			FREEZE	70	●
			VOICE SET	47	●
		HARMONY/ECHO		47	●
		SCREEN OUT		90	—
		MIDI	SYSTEM	—	●
			TRANSMIT	—	●
			RECEIVE	—	●
			BASS	—	●
			CHORD DETECT	—	●
			MFC10	—	●
		UTILITY	CONFIG1	99	●
			CONFIG2	99	●
			MEDIA	95, 99	●
			OWNER	17, 18, 35, 99	●
			SYSTEM RESET	99	●
		[VOICE CREATOR]	LIBRARY LOAD	47	●
			LIBRARY EDIT	47	●
LIBRARY SAVE	47		●		
INDIVIDUAL LOAD	47		●		
CUSTOM VOICE EDIT via PC	47		●		
WAVE IMPORT	47		●		

No.	Button/Control	Display	Page	Reference Manual	
	[DIGITAL RECORDING]	SONG CREATOR	REC MODE	63	●
			CHANNEL	63	●
			CHORD	63	●
			1-16	63	●
			SYS/EX.	63	●
			LYRICS	63	●
		STYLE CREATOR	BASIC	56	●
			ASSEMBLY	56	●
			GROOVE	56	●
			CHANNEL	56	●
			PARAMETER	56	●
		MULTI PAD CREATOR	RECORD	65	●
			EDIT	65	●
22 HARD DISK RECORDER	[REC]	AUDIO SETTING display	(REC MODE)	72	—
	[STOP]	—		75	—
	[PLAY/PAUSE]	—		75	—
	[PREV]/[NEXT]	AUDIO POSITION (pop-up)		75	—
	[SELECT]	Audio Selection display		75	●
	[SETTING]	AUDIO SETTING display	VOLUME	71	●
		REC MODE	73	●	
23 VOICE EFFECT	[HARMONY/ECHO]	—		44	—
	[INITIAL TOUCH]	—		44	—
	[SUSTAIN]	—		44	—
	[MONO]	—		44	—
	[DSP]	—		44	—
	[VARIATION]	—		44	—
24	[INTERNET]	Special Website (only when connected to the internet)		83	●
25	[MUSIC FINDER]	MUSIC FINDER display	ALL	66	—
			FAVORITE	67	●
			SEARCH1	67	—
			SEARCH2	67	—
26 VOICE	[PIANO]–[SYNTH]	Voice Selection display (Preset Voices)		36	—
	[ORGAN FLUTES]	Organ Flutes Voice Set display	FOOTAGE	46	—
			VOLUME/ATTACK	47	●
			EFFECT/EQ	47	●
	[EXPANSION]	Voice Selection display (Expansion Voices)		39	●
[USER DRIVE]	Voice Selection display (USER)		37	—	
27 REGISTRATION MEMORY	REGIST BANK [-]/[+]	REGISTRATION BANK (pop-up)		70	—
	[FREEZE]	—		70	●
	[MEMORY]	REGISTRATION MEMORY CONTENTS display		68	—
	[1]–[8]	—		68	—
28 ONE TOUCH SETTING	[1]–[4]	—		53	●
29 PART SELECT	[LEFT]–[RIGHT 3]	—		38	—
30 PART ON/OFF	[LEFT HOLD]	—		39	—
	[LEFT]–[RIGHT 3]	—		38	—

# Specifications

<b>Keyboard</b>	Keys	61 keys (C1–C6) Initial Touch/Aftertouch
	Type	Organ (FSX)
<b>Voice</b>	Polyphony (max)	128
	Layer	R1/R2/R3/L
	Split	Style (default point: F#2), Left (default point: F#2), Right 3 (default point: G2)
	Voices	749 Voices + 20 Organ Flutes + 480 XG Voices + 256 GM2 Voice + 35 Drum/SFX kits (And GS Voices for GS Song playback)
	MegaVoice	23
	S. Articulation2! (AEM technology)	11 [TRUMPET] JazzTrumpet / ClassicTrumpet [SAXOPHONE] JazzSax / Breathysax [FLUTE/CLARINET] Clarinet / BalladClarinet / RomanceClarinet / IrishPipeAir / IrishPipeDance [ACCORDION] Harmonica / BluesHarp
	S. Articulation!	53
	Sweet!	26
	Cool!	58
	Live!	70
	Live! Drums	12 (Included Live! SFX)
Organ Flutes!	20 Presets	
<b>Voice Expandability</b>	Custom Voices	Yes (Wave Addition: Normal Voices, Drum Voices)
	Premium Voices	Yes (optional DIMM memory is necessary)
	Voice Set	Yes
<b>Style</b>	Styles	450
	Format	SFF GE
	Control	SYNC STOP, SYNC START, START/STOP, AUTO FILL IN
	Section	Intro x 3, Ending x 3, Main x 4, Fill In x 4, Break
	Fingering	Single Finger, Fingered, Fingered On Bass, Multi Finger, AI Fingered, Full Keyboard, AI Full Keyboard
	Style Creator	Yes
	RAM Capacity per a Style	approx. 120 KB
<b>OTS (One Touch Setting)</b>		4 for each Style
<b>Music Finder</b>	Preset Records	1850
	Music Finder Plus	Yes
<b>Song</b>	Preset Songs	5 Sample Songs
	Control	REC, STOP, PLAY/PAUSE, REW, FF, METRONOME
	Recording	Quick Recording, Multi Recording, Step Recording
	Tracks	16
	RAM Capacity per a Song	approx. 300 KB
	Lyric Display	Yes
	Score Display	Yes
Song Position Jump	4 point / Loop	
<b>Style/Song Control</b>		FADE IN/OUT, TAP TEMPO, TEMPO (5–500)
<b>Data Compatibility</b>		GM, XG, XF, SFF, SFF GE, GM2/GS (for Song Playback)
<b>Hard Disk Recorder</b>	Tracks	Play: 2 Stereo Track REC: 1 Stereo Track
	Control	REC, STOP, PLAY/PAUSE, PREV, NEXT, SELECT, SETTING
	File Format	Wave (16-bit, 44.1 kHz, stereo)
<b>MultiPad</b>	Preset	123 banks x 4 Pads
	Control	Pad 1–4, SELECT, STOP, SYNC START
<b>Vocal Harmony</b>		60 Preset + 10 user



<b>Effects</b>	Reverb	42	
	Chorus	106	
	DSP1–DSP7	272	
	DSP8–DSP9	272 (for Style)	
	Master Compressor	5 presets + 5 user settings	
	Master Equalizer	5 presets + 2 user settings	
	Harmony/Echo	Yes	
	Sustain Button	Yes	
<b>Registration Memory</b>	Buttons	1–8	
	Control	Bank select, Memory, Freeze, Registration Sequence	
<b>Control</b>	Pitch Bend Wheel	Yes	
	Modulation Wheel	Yes	
	Articulation Switch	ART. 1, ART. 2	
	Sliders	9 (including 1 assignable)	
<b>Transpose</b>	-12–0–12 (Keyboard/Song/Master)		
<b>Tuning</b>	414.8–440–466.8 Hz		
<b>Display</b>	640 x 480 dots TFT VGA color 7.5 inch LCD		
	Language	5 languages (English, German, French, Spanish, Italian)	
	Text Viewer	Yes	
	Wallpaper Customize	Yes	
<b>Storage</b>	USB to Device		
	Internal Flash	3.2MB	
	Hard Disk (installable)	Yes	
<b>Terminals</b>	USB TO HOST	USB 2.0 HighSpeed x 1	
	USB TO DEVICE	USB 2.0 HighSpeed x 2 (Front/Back)	
	MIDI	MIDI A (IN/OUT), MIDI B (IN/OUT)	
	FOOT PEDAL	1 (SUSTAIN), 2 (ARTICULATION 1), 3 (VOLUME), Function Assignable	
	Audio	LINE OUT MAIN (L/L+R, R)	
		LINE OUT SUB (1, 2)	
		LOOP SEND (L/L+R, R) / AUX OUT (Level Fixed): Selectable	
		LOOP RETURN (L/L+R, R) / AUX IN (with TRIM control)	
		MIC/LINE IN (with TRIM control)	
		PHONES	
	RGB OUT	Yes	
	VIDEO OUT	NTSC / PAL Composit	
	LAN	Yes (Internet Direct Connection)	
	For Option Speaker	To Satellite Speaker (L/R), To Sub Woofer (L/R)	
Power Supply	AC IN		
<b>Dimensions [W x D x H] (without Music Rest)</b>	1140 x 450 x 143 mm		
<b>Weight (without Music Rest)</b>	15 kg		

<b>Optional Accessories</b>	Speaker	TRS-MS02
	Headphones	HPE-150
	Footswitch	FC4/FC5
	Foot Controller	FC7
	MIDI Foot Controller	MFC10
	Floppy Disk Drive	UD-FD01
	Keyboard Stand	L-7S

\* Specifications and descriptions in this owner's manual are for information purposes only. Yamaha Corp. reserves the right to change or modify products or specifications at any time without prior notice. Since specifications, equipment or options may not be the same in every locale, please check with your Yamaha dealer.

# Index

## Numerics

- [1 ▲▼]–[8 ▲▼] buttons ..... 21
- 1–16 ..... 63
- [1]–[8] sliders ..... 21

## A

- [A]–[J] ..... 20
- AC IN ..... 16
- ACMP ..... 48
- ADD TO FAVORITE ..... 67
- AEM ..... 7, 40
- ART. 1/ART. 2 ..... 42
- Articulation Effect ..... 42
- ASSEMBLY ..... 56
- ASSIGN ..... 21
- ASSIGN SLIDER ..... 21
- ASSIGNABLE FOOT PEDAL ..... 93
- Audio Setting display ..... 71
- Auto Accompaniment ..... 48
- AUTO FILL IN ..... 51
- AUX IN/LOOP RETURN ..... 89
- AUX OUT/LOOP SEND ..... 89

## B

- Backup ..... 35
- BALANCE ..... 55, 75
- BASIC ..... 56
- BASS ..... 54
- Bookmark ..... 84
- Bounce Recording ..... 74
- BREAK ..... 51
- BROWSER ..... 85

## C

- CD-ROM ..... 6
- CHANGE MENU ..... 76
- CHANNEL (Song Creator) ..... 63
- CHANNEL (Style Creator) ..... 56
- CHANNEL ON/OFF (Song) ..... 63
- CHANNEL ON/OFF (Style) ..... 54
- CHD1/2 (Chord 1/ 2) ..... 54
- CHORD ..... 63
- CHORD FINGERING ..... 56
- Chord Match ..... 65

- CMP ..... 78
- Computer ..... 96
- Computer Monitor ..... 90
- CONFIG1 ..... 99
- CONFIG2 ..... 99
- Connect Information ..... 86
- Connection ..... 88
- Cookie ..... 87
- COPY ..... 31
- Custom Voice ..... 39
- CUSTOM VOICE EDIT via PC ..... 47
- CUT ..... 32

## D

- DATA ENTRY ..... 22
- Data List ..... 8
- DELETE ..... 32
- DEMO ..... 19
- DEMO (Voice) ..... 37
- DHCP ..... 86
- DIGITAL RECORDING ... 56, 63, 65
- DIMM ..... 102
- DIRECT ACCESS ..... 23
- DNS server ..... 86
- Drum Voice ..... 39
- DSP ..... 44

## E

- EFFECT ..... 78
- EFFECT (Microphone) ..... 92
- EFFECT/EQ ..... 47
- Encryption ..... 86
- ENDING/rit. .... 50
- ENTER ..... 22
- Entering characters ..... 34
- EQ ..... 78
- EXIT ..... 22
- Expansion Voice ..... 39
- EXPORT ..... 76

## F

- Factory Reset ..... 35
- FADE IN/OUT ..... 51
- Fast Forward ..... 60

- FAVORITE ..... 67
- FF ..... 60
- File ..... 26
- FILE ACCESS ..... 29
- File Selection display ..... 25
- FILES (Music Finder) ..... 67
- Fill-in section ..... 51
- FILTER ..... 78
- Folder ..... 26
- FOLDER (File Selection display) ..... 33
- Foot Controller ..... 93
- FOOT PEDAL ..... 93
- Footage ..... 46
- Footswitch ..... 93
- FORMAT ..... 95
- FREEZE ..... 70
- FUNCTION ..... 110

## G

- GAIN ..... 80
- Gateway ..... 86
- GM ..... 7, 47
- GROOVE ..... 56
- GS ..... 7
- Guide function ..... 63
- Guitar ..... 91

## H

- Hard Disk Recorder ..... 71
- Harmony ..... 92
- HARMONY/ECHO ..... 44
- HD ..... 26
- HDR ..... 75
- Headphones ..... 15
- Home Page ..... 84

## I

- INDIVIDUAL LOAD ..... 47
- INFO (Registration Memory) ..... 70
- INFO (Voice) ..... 37, 40
- INITIAL TOUCH ..... 44
- Initialize (Factory Reset) ..... 35
- Initialize (Internet) ..... 87
- INPUT VOLUME ..... 91

INTERNET ..... 83  
 Internet Direct Connection ..... 82  
 Internet Settings display ..... 85  
 INTRO ..... 50  
 IP address ..... 86

## K

Keyboard Part ..... 38  
 KEYBOARD/PANEL ..... 42, 47

## L

LAN ..... 86  
 LAN terminal ..... 82  
 Language ..... 17  
 LCD ..... 13  
 LEFT ..... 38  
 Left Hold ..... 39  
 LIBRARY EDIT ..... 47  
 LIBRARY LOAD ..... 47  
 LIBRARY SAVE ..... 47  
 LINE IN/MIC ..... 89, 91  
 LINE OUT ..... 78, 88  
 List view ..... 28  
 LOOP ..... 63  
 LOOP RETURN ..... 89  
 LOOP SEND ..... 89  
 Lyrics ..... 61  
 LYRICS (Song Creator) ..... 63  
 LYRICS/TEXT ..... 61

## M

Main display ..... 24  
 MAIN PICTURE ..... 18  
 Main section ..... 51  
 Main track ..... 71  
 MAIN VARIATION ..... 51  
 Master Compressor ..... 80  
 MASTER TUNE ..... 47  
 MASTER VOLUME ..... 16  
 MEDIA ..... 95, 99  
 MegaVoice ..... 39  
 MEMORY (List view) ..... 29  
 MEMORY (Registration Memory)  
 ..... 56, 68

MENU ..... 13  
 Message ..... 23  
 METRONOME ..... 58  
 MFC10 ..... 110  
 MIC SETTING ..... 93  
 Microphone ..... 91  
 MIDI Basics ..... 8  
 MIDI Channel ..... 57  
 MIDI IN ..... 98  
 MIDI OUT ..... 98  
 MIXING CONSOLE ..... 78  
 Modulation Wheel ..... 42  
 MONITOR TYPE ..... 90  
 MONO ..... 44  
 Multi Pad ..... 64  
 MULTI PAD CONTROL ..... 64  
 Multi Pad Creator ..... 65  
 MUSIC FINDER ..... 66  
 MUSIC FINDER + ..... 67  
 Music genre ..... 66  
 Music notation ..... 61  
 Music rest ..... 14

## N

NAME ..... 33  
 NEXT (Hard Disk Recorder) ..... 75  
 NEXT (Song playback) ..... 59  
 NEXT CANCEL ..... 59  
 Normal view ..... 28  
 Normalize ..... 77  
 Number input ..... 28

## O

ONE TOUCH SETTING ..... 53  
 Optional DIMM ..... 102  
 Optional speakers ..... 100  
 ORGAN FLUTES ..... 46  
 ORGAN TYPE ..... 46  
 Others (Internet) ..... 86  
 OTS INFO ..... 53  
 OTS LINK ..... 53  
 OWNER ..... 17–18, 35, 99  
 Owner Name ..... 18

## P

PAD ..... 54  
 Panel Button chart ..... 109  
 PARAMETER (Style Creator) ..... 56  
 PART ON/OFF ..... 38  
 PART SELECT ..... 38  
 PASTE ..... 31–32  
 Pause ..... 60  
 Percussion Voice ..... 39  
 PHONES ..... 15  
 PHR1/2 (Phrase1/2) ..... 54  
 Phrase Mark ..... 60  
 PITCH BEND RANGE ..... 41  
 Pitch Bend Wheel ..... 41  
 PLAY/PAUSE (Hard Disk Recorder) 75  
 PLAY/PAUSE (Song) ..... 58–60  
 Playlist ..... 77  
 POWER ON/OFF ..... 16  
 Powered speaker ..... 88  
 Premium Voice ..... 39  
 PRESET ..... 26  
 Preset Voice ..... 39  
 PRESETS (Organ Flutes) ..... 46  
 PREV ..... 75  
 Pro ..... 49  
 PROPERTY ..... 75  
 Prot. 1 ..... 60  
 Prot. 2 Edit ..... 60  
 Prot. 2 Orig ..... 60  
 Protected Song ..... 60  
 Proxy server ..... 86

## Q

Quick Recording ..... 57

## R

RATIO ..... 80  
 REC (Hard Disk Recorder) ..... 72  
 REC (Song) ..... 57  
 REC MODE (Hard Disk Recorder) 73  
 REC MODE (Song Creator) ..... 63  
 REC MONITOR ..... 71  
 Record (Music Finder) ..... 66  
 RECORD EDIT ..... 67

- Recording ..... 71
- Redo ..... 72
- Reference Manual ..... 8
- REFRESH ..... 84
- REGIST BANK ..... 69
- REGISTRATION MEMORY ..... 68
- REGISTRATION SEQUENCE ..... 70
- Repeat ..... 63
- REPertoire ..... 52
- Re-recording ..... 77
- RESTORE ..... 35
- REW ..... 60
- Rewind ..... 60
- RGB OUT ..... 90
- RHY1/2 (Rhythm 1/2) ..... 54
- RIGHT 1–3 ..... 38
- ROTARY SP SPEED ..... 46
- S**
- SA ..... 40
- SA2 ..... 40
- SAVE ..... 30
- SCALE TUNE ..... 47
- SCORE ..... 61
- SCREEN CONTENT ..... 90
- SCREEN OUT ..... 90
- SEARCH ..... 67
- Section ..... 51
- SELECT (Hard Disk Recorder) ..... 75
- SELECT (Multi Pad) ..... 64
- Session ..... 49
- SETTING (Hard Disk Recorder) .... 71
- SETTING (Internet) ..... 85
- SFF ..... 7
- SFF GE ..... 7, 49
- SFX (sound effects) ..... 39
- SONG ..... 57, 59
- Song Creator ..... 63
- Song Position Marker ..... 62
- SONG SETTING ..... 63
- SORT BY ..... 66
- SORT ORDER ..... 66
- SP (Song Position) ..... 62
- SPLIT POINT ..... 56
- Split Point ..... 38
- SSID ..... 86
- START/END POINT ..... 77
- START/STOP ..... 49–50
- STEP REC ..... 56
- STOP (Multi Pad) ..... 64
- STOP (Song) ..... 59
- STYLE ..... 48
- Style Creator ..... 56
- Style File Format ..... 7
- STYLE SETTING ..... 56
- Sub track ..... 73
- Subnet mask ..... 86
- Super Articulation Voice ..... 40, 42
- SUSTAIN ..... 44
- SYNC START ..... 48, 50
- SYNC STOP ..... 50
- Synchro Start (Multi Pad) ..... 65
- SYS/EX. .... 63
- SYSTEM RESET ..... 35, 99
- T**
- TAB ..... 21
- TALK ..... 93
- TAP TEMPO ..... 51
- TEMPO ..... 51
- TEMPO LOCK ..... 66
- Text ..... 61
- THRESHOLD ..... 80
- TO LEFT SPEAKER ..... 100
- TO RIGHT SPEAKER ..... 100
- TO SUB WOOFER ..... 101
- TRACK DELETE ..... 74
- TRACK SELECT ..... 73
- TRANSPOSE ..... 41
- TRANSPOSE ASSIGN ..... 47
- TRIM ..... 89, 91
- Troubleshooting ..... 106
- TRS-MS02 ..... 100
- TUNE ..... 78
- TV monitor ..... 90
- U**
- Undo ..... 72
- UP ..... 27
- UPPER OCTAVE ..... 41
- USB ..... 26
- USB cable ..... 96
- USB storage device ..... 94
- USB Storage Mode ..... 97
- USB TO DEVICE ..... 94
- USB TO HOST ..... 96
- USB Wireless LAN Adaptor ..... 83
- USB-MIDI driver ..... 96
- USER ..... 26
- USER DRIVE ..... 37
- Utility ..... 99
- V**
- VARIATION ..... 44
- VERSION ..... 18
- VH ..... 7
- VH TYPE SELECT ..... 92
- Vibrato ..... 42
- VIBRATO (Organ Flutes) ..... 46
- VIDEO OUT ..... 90
- VIEW ..... 28
- VOCAL HARMONY ..... 92
- VOICE ..... 36
- VOICE CREATOR ..... 47
- Voice Effect ..... 44
- VOICE SET ..... 44, 47
- Voice Type ..... 39
- VOL/VOICE ..... 78
- Volume ..... 55
- Volume (Hard Disk Recorder) ..... 75
- VOLUME/ATTACK ..... 47
- W**
- WAVE IMPORT (Hard Disk Recorder) ..... 77
- WAVE IMPORT (Voice Creator) .... 47
- WEP key ..... 86
- Wireless LAN ..... 86
- X**
- XF ..... 7
- XG ..... 7, 47

# Limited Warranty

**90 DAYS LABOR**

**1 YEAR PARTS**

Yamaha Corporation of America, hereafter referred to as Yamaha, warrants to the original consumer of a product included in the categories listed below, that the product will be free of defects in materials and/or workmanship for the periods indicated. This warranty is applicable to all models included in the following series of products:

## DIGITAL WORKSTATION

If during the first 90 days that immediately follows the purchase date, your new Yamaha product covered by this warranty is found to have a defect in material and/or workmanship, Yamaha and/or its authorized representative will repair such defect without charge for parts or labor.

If parts should be required after this 90 day period but within the one year period that immediately follows the purchase date, Yamaha will, subject to the terms of this warranty, supply these parts without charge. However, charges for labor, and/or any miscellaneous expenses incurred are the consumers responsibility. Yamaha reserves the right to utilize reconditioned parts in repairing these products and/or to use reconditioned units as warranty replacements.

**THIS WARRANTY IS THE ONLY EXPRESS WARRANTY WHICH YAMAHA MAKES IN CONNECTION WITH THESE PRODUCTS. ANY IMPLIED WARRANTY APPLICABLE TO THE PRODUCT, INCLUDING THE WARRANTY OF MERCHANTABILITY IS LIMITED TO THE DURATION OF THE EXPRESS WARRANTY. YAMAHA EXCLUDES AND SHALL NOT BE LIABLE IN ANY EVENT FOR INCIDENTAL OR CONSEQUENTIAL DAMAGES.**

Some states do not allow limitations that relate to implied warranties and/or the exclusion of incidental or consequential damages. Therefore, these limitations and exclusions may not apply to you.

This warranty gives you specific legal rights. You may also have other rights which vary from state to state.

## CONSUMERS RESPONSIBILITIES

If warranty service should be required, it is necessary that the consumer assume certain responsibilities:

1. Contact the Customer Service Department of the retailer selling the product, or any retail outlet authorized by Yamaha to sell the product for assistance. You may also contact Yamaha directly at the address provided below.
2. Deliver the unit to be serviced under warranty to: the retailer selling the product, an authorized service center, or to Yamaha with an explanation of the problem. Please be prepared to provide proof purchase date (sales receipt, credit card copy, etc.) when requesting service and/or parts under warranty.
3. Shipping and/or insurance costs are the consumers responsibility.\* Units shipped for service should be packed securely.

\*Repaired units will be returned PREPAID if warranty service is required within the first 90 days.

**IMPORTANT:** Do NOT ship anything to ANY location without prior authorization. A Return Authorization (RA) will be issued that has a tracking number assigned that will expedite the servicing of your unit and provide a tracking system if needed.

4. Your owners manual contains important safety and operating instructions. It is your responsibility to be aware of the contents of this manual and to follow all safety precautions.

## EXCLUSIONS

This warranty does not apply to units whose trade name, trademark, and/or ID numbers have been altered, defaced, exchanged removed, or to failures and/or damages that may occur as a result of:

1. Neglect, abuse, abnormal strain, modification or exposure to extremes in temperature or humidity.
2. Improper repair or maintenance by any person who is not a service representative of a retail outlet authorized by Yamaha to sell the product, an authorized service center, or an authorized service representative of Yamaha.
3. This warranty is applicable only to units sold by retailers authorized by Yamaha to sell these products in the U.S.A., the District of Columbia, and Puerto Rico. This warranty is not applicable in other possessions or territories of the U.S.A. or in any other country.

Please record the model and serial number of the product you have purchased in the spaces provided below.

Model \_\_\_\_\_ Serial # \_\_\_\_\_ Sales Slip # \_\_\_\_\_

Purchased from \_\_\_\_\_ Date \_\_\_\_\_  
(Retailer)

**YAMAHA CORPORATION OF AMERICA**  
**Electronic Service Division**  
**6600 Orangethorpe Avenue**  
**Buena Park, CA 90620**

**KEEP THIS DOCUMENT FOR YOUR RECORDS. DO NOT MAIL!**

## FCC INFORMATION (U.S.A.)

### 1. IMPORTANT NOTICE: DO NOT MODIFY THIS UNIT!

This product, when installed as indicated in the instructions contained in this manual, meets FCC requirements. Modifications not expressly approved by Yamaha may void your authority, granted by the FCC, to use the product.

### 2. IMPORTANT: When connecting this product to accessories and/or another product use only high quality shielded cables. Cable/s supplied with this product MUST be used. Follow all installation instructions. Failure to follow instructions could void your FCC authorization to use this product in the USA.

### 3. NOTE: This product has been tested and found to comply with the requirements listed in FCC Regulations, Part 15 for Class "B" digital devices. Compliance with these requirements provides a reasonable level of assurance that your use of this product in a residential environment will not result in harmful interference with other electronic devices. This equipment generates/uses radio frequencies and, if not installed and used according to the instructions found in the users manual, may cause interference harmful to the operation of other electronic devices. Compliance with FCC regulations does

not guarantee that interference will not occur in all installations. If this product is found to be the source of interference, which can be determined by turning the unit "OFF" and "ON", please try to eliminate the problem by using one of the following measures:

Relocate either this product or the device that is being affected by the interference.

Utilize power outlets that are on different branch (circuit breaker or fuse) circuits or install AC line filter/s.

In the case of radio or TV interference, relocate/reorient the antenna. If the antenna lead-in is 300 ohm ribbon lead, change the lead-in to co-axial type cable.

If these corrective measures do not produce satisfactory results, please contact the local retailer authorized to distribute this type of product. If you can not locate the appropriate retailer, please contact Yamaha Corporation of America, Electronic Service Division, 6600 Orangethorpe Ave, Buena Park, CA90620

The above statements apply ONLY to those products distributed by Yamaha Corporation of America or its subsidiaries.

\* This applies only to products distributed by YAMAHA CORPORATION OF AMERICA.

(class B)

### IMPORTANT NOTICE FOR THE UNITED KINGDOM

#### Connecting the Plug and Cord

**WARNING: THIS APPARATUS MUST BE EARTHED**  
IMPORTANT. The wires in this mains lead are coloured in accordance with the following code:

GREEN-AND-YELLOW : EARTH  
BLUE : NEUTRAL  
BROWN : LIVE

As the colours of the wires in the mains lead of this apparatus may not correspond with the coloured markings identifying the terminals in your plug proceed as follows:

The wire which is coloured GREEN-and-YELLOW must be connected to the terminal in the plug which is marked by the letter E or by the safety earth symbol  or colored GREEN or GREEN-and-YELLOW.

The wire which is coloured BLUE must be connected to the terminal which is marked with the letter N or coloured BLACK.

The wire which is coloured BROWN must be connected to the terminal which is marked with the letter L or coloured RED.

\* This applies only to products distributed by Yamaha Music U.K. Ltd.

(3 wires)

This product contains a high intensity lamp that contains a small amount of mercury. Disposal of this material may be regulated due to environmental considerations. For disposal information in the United States, refer to the Electronic Industries Alliance web site:  
[www.eiae.org](http://www.eiae.org)

\* This applies only to products distributed by  
YAMAHA CORPORATION OF AMERICA.

(mercury)

### COMPLIANCE INFORMATION STATEMENT (DECLARATION OF CONFORMITY PROCEDURE)

Responsible Party : Yamaha Corporation of America  
Address : 6600 Orangethorpe Ave., Buena Park, Calif. 90620  
Telephone : 714-522-9011  
Type of Equipment : DIGITAL KEYBOARD  
Model Name : TYROS3

This device complies with Part 15 of the FCC Rules.

Operation is subject to the following two conditions:

- 1) this device may not cause harmful interference, and
- 2) this device must accept any interference received including interference that may cause undesired operation.

See user manual instructions if interference to radio reception is suspected.

\* This applies only to products distributed by  
YAMAHA CORPORATION OF AMERICA.

(FCC DoC)

For details of products, please contact your nearest Yamaha representative or the authorized distributor listed below.

Pour plus de détails sur les produits, veuillez-vous adresser à Yamaha ou au distributeur le plus proche de vous figurant dans la liste suivante.

Die Einzelheiten zu Produkten sind bei Ihrer unten aufgeführten Niederlassung und bei Yamaha Vertragshändlern in den jeweiligen Bestimmungsländern erhältlich.

Para detalles sobre productos, contacte su tienda Yamaha más cercana o el distribuidor autorizado que se lista debajo.

## NORTH AMERICA

### CANADA

**Yamaha Canada Music Ltd.**  
135 Milner Avenue, Scarborough, Ontario,  
M1S 3R1, Canada  
Tel: 416-298-1311

### U.S.A.

**Yamaha Corporation of America**  
6600 Orangethorpe Ave., Buena Park, Calif. 90620,  
U.S.A.  
Tel: 714-522-9011

## CENTRAL & SOUTH AMERICA

### MEXICO

**Yamaha de México S.A. de C.V.**  
Calz. Javier Rojo Gómez #1149,  
Col. Guadalupe del Moral  
C.P. 09300, México, D.F., México  
Tel: 55-5804-0600

### BRAZIL

**Yamaha Musical do Brasil Ltda.**  
Rua Joaquim Floriano, 913 - 4º andar, Itaim Bibi,  
CEP 04534-013 Sao Paulo, SP. BRAZIL  
Tel: 011-3704-1377

### ARGENTINA

**Yamaha Music Latin America, S.A.**  
**Sucursal de Argentina**  
Olga Cossetini 1553, Piso 4 Norte  
Madero Este-C1107CEK  
Buenos Aires, Argentina  
Tel: 011-4119-7000

### PANAMA AND OTHER LATIN AMERICAN COUNTRIES/ CARIBBEAN COUNTRIES

**Yamaha Music Latin America, S.A.**  
Torre Banco General, Piso 7, Urbanización Marbella,  
Calle 47 y Aquilino de la Guardia,  
Ciudad de Panamá, Panamá  
Tel: +507-269-5311

## EUROPE

### THE UNITED KINGDOM/IRELAND

**Yamaha Music U.K. Ltd.**  
Sherbourne Drive, Tilbrook, Milton Keynes,  
MK7 8BL, England  
Tel: 01908-366700

### GERMANY

**Yamaha Music Europe GmbH**  
Siemensstraße 22-34, 25462 Rellingen, Germany  
Tel: 04101-3030

### SWITZERLAND/LIECHTENSTEIN

**Yamaha Music Europe GmbH**  
**Branch Switzerland in Zürich**  
Seefeldstrasse 94, 8008 Zürich, Switzerland  
Tel: 01-383 3990

### AUSTRIA

**Yamaha Music Europe GmbH Branch Austria**  
Schleiergasse 20, A-1100 Wien, Austria  
Tel: 01-60203900

### CZECH REPUBLIC/SLOVAKIA/ HUNGARY/SLOVENIA

**Yamaha Music Europe GmbH Branch Austria**  
Schleiergasse 20, A-1100 Wien, Austria  
Tel: 01-602039025

### POLAND

**Yamaha Music Europe GmbH**  
**Branch Sp.z o.o. Oddział w Polsce**  
ul. 17 Stycznia 56, PL-02-146 Warszawa, Poland  
Tel: 022-868-07-57

### THE NETHERLANDS/ BELGIUM/LUXEMBOURG

**Yamaha Music Europe Branch Benelux**  
Clarissenhof 5-b, 4133 AB Vianen, The Netherlands  
Tel: 0347-358 040

### FRANCE

**Yamaha Musique France**  
BP 70-77312 Marne-la-Vallée Cedex 2, France  
Tel: 01-64-61-4000

### ITALY

**Yamaha Musica Italia S.P.A.**  
Viale Italia 88, 20020 Lainate (Milano), Italy  
Tel: 02-935-771

### SPAIN/PORTUGAL

**Yamaha Música Ibérica, S.A.**  
Ctra. de la Coruna km. 17, 200, 28230  
Las Rozas (Madrid), Spain  
Tel: 91-639-8888

### GREECE

**Philippos Nakas S.A. The Music House**  
147 Skiathou Street, 112-55 Athens, Greece  
Tel: 01-228 2160

### SWEDEN

**Yamaha Scandinavia AB**  
J. A. Wettergrens Gata 1, Box 30053  
S-400 43 Göteborg, Sweden  
Tel: 031 89 34 00

### DENMARK

**YS Copenhagen Liaison Office**  
Generatorvej 6A, DK-2730 Herlev, Denmark  
Tel: 44 92 49 00

### FINLAND

**F-Musiikki Oy**  
Kluuvikatu 6, P.O. Box 260,  
SF-00101 Helsinki, Finland  
Tel: 09 618511

### NORWAY

**Norsk filial av Yamaha Scandinavia AB**  
Grini Næringspark 1, N-1345 Østerås, Norway  
Tel: 67 16 77 70

### ICELAND

**Skiifan HF**  
Skeifan 17 P.O. Box 8120, IS-128 Reykjavik, Iceland  
Tel: 525 5000

### RUSSIA

**Yamaha Music (Russia)**  
Office 4015, entrance 2, 21/5 Kuznetskii  
Most street, Moscow, 107996, Russia  
Tel: 495 626 0660

### OTHER EUROPEAN COUNTRIES

**Yamaha Music Europe GmbH**  
Siemensstraße 22-34, 25462 Rellingen, Germany  
Tel: +49-4101-3030

## AFRICA

**Yamaha Corporation,**  
**Asia-Pacific Music Marketing Group**  
Nakazawa-cho 10-1, Naka-ku, Hamamatsu,  
Japan 430-8650  
Tel: +81-53-460-2312

## MIDDLE EAST

### TURKEY/CYPRUS

**Yamaha Music Europe GmbH**  
Siemensstraße 22-34, 25462 Rellingen, Germany  
Tel: 04101-3030

### OTHER COUNTRIES

**Yamaha Music Gulf FZE**  
LOB 16-513, P.O.Box 17328, Jubel Ali,  
Dubai, United Arab Emirates  
Tel: +971-4-881-5868

## ASIA

### THE PEOPLE'S REPUBLIC OF CHINA

**Yamaha Music & Electronics (China) Co.,Ltd.**  
2F, Yunhedasha, 1818 Xinzha-lu, Jingan-qu,  
Shanghai, China  
Tel: 021-6247-2211

### HONG KONG

**Tom Lee Music Co., Ltd.**  
11/F., Silvercord Tower 1, 30 Canton Road,  
Tsimshatsui, Kowloon, Hong Kong  
Tel: 2737-7688

### INDIA

**Yamaha Music India Pvt. Ltd.**  
5F Ambience Corporate Tower Ambience Mall Complex  
Ambience Island, NH-8, Gurgaon-122001, Haryana, India  
Tel: 0124-466-5551

### INDONESIA

**PT. Yamaha Music Indonesia (Distributor)**  
**PT. Nusantara**  
Gedung Yamaha Music Center, Jalan Jend. Gatot  
Subroto Kav. 4, Jakarta 12930, Indonesia  
Tel: 21-520-2577

### KOREA

**Yamaha Music Korea Ltd.**  
8F, 9F, Dongsung Bldg. 158-9 Samsung-Dong,  
Kangnam-Gu, Seoul, Korea  
Tel: 080-004-0022

### MALAYSIA

**Yamaha Music Malaysia, Sdn., Bhd.**  
Lot 8, Jalan Perbandaran, 47301 Kelana Jaya,  
Petaling Jaya, Selangor, Malaysia  
Tel: 3-78030900

### PHILIPPINES

**Yupangco Music Corporation**  
339 Gil J. Puyat Avenue, P.O. Box 885 MCPO,  
Makati, Metro Manila, Philippines  
Tel: 819-7551

### SINGAPORE

**Yamaha Music Asia Pte., Ltd.**  
#03-11 A-Z Building  
140 Paya Lebor Road, Singapore 409015  
Tel: 747-4374

### TAIWAN

**Yamaha KHS Music Co., Ltd.**  
3F, #6, Sec.2, Nan Jing E. Rd. Taipei.  
Taiwan 104, R.O.C.  
Tel: 02-2511-8688

### THAILAND

**Siam Music Yamaha Co., Ltd.**  
4, 6, 15 and 16<sup>th</sup> floor, Siam Motors Building,  
891/1 Rama 1 Road, Wangmai,  
Pathumwan, Bangkok 10330, Thailand  
Tel: 02-215-2626

### OTHER ASIAN COUNTRIES

**Yamaha Corporation,**  
**Asia-Pacific Music Marketing Group**  
Nakazawa-cho 10-1, Naka-ku, Hamamatsu,  
Japan 430-8650  
Tel: +81-53-460-2317

## OCEANIA

### AUSTRALIA

**Yamaha Music Australia Pty. Ltd.**  
Level 1, 99 Queensbridge Street, Southbank,  
Victoria 3006, Australia  
Tel: 3-9693-5111

### NEW ZEALAND

**Music Works LTD**  
P.O.BOX 6246 Wellesley, Auckland 4680,  
New Zealand  
Tel: 9-634-0099

### COUNTRIES AND TRUST TERRITORIES IN PACIFIC OCEAN

**Yamaha Corporation,**  
**Asia-Pacific Music Marketing Group**  
Nakazawa-cho 10-1, Naka-ku, Hamamatsu,  
Japan 430-8650  
Tel: +81-53-460-2312

**HEAD OFFICE** Yamaha Corporation, Pro Audio & Digital Musical Instrument Division  
Nakazawa-cho 10-1, Naka-ku, Hamamatsu, Japan 430-8650  
Tel: +81-53-460-3273



Yamaha Home Keyboards Home Page  
<http://music.yamaha.com/homekeyboard>  
Yamaha Manual Library  
<http://www.yamaha.co.jp/manual/>

U.R.G., Pro Audio & Digital Musical Instrument Division, Yamaha Corporation  
© 2008 Yamaha Corporation

WP10110 9XXPODHX.X-05C0  
Printed in Japan