

DME Designer

Version 4.0

OWNER'S MANUAL

Getting Started with DME Designer

In this manual the abbreviation “DME” refers to the DME64N/DME24N/DME8i-C/DME8o-C/DME4io-C/DME8i-ES/DME8o-ES/DME4io-ES. The abbreviation “DME Satellite” refers to the DME8i-C/DME8o-C/DME4io-C/DME8i-ES/DME8o-ES/DME4io-ES.

Your DME, SP2060, ICP1 and the DME Designer software, let you build a custom audio system installation that can support an incredible variety of conditions. You can build an entire system from input to output with the DME Designer software, then send the system data to the DME and SP2060 which become independent processors.

An amazing variety of applications are possible, including audio installations, sub-mixing, speaker system control, matrix/routing, and multi-effect processing.

NOTE

Here the abbreviation “DME” does not include the “DME32.”

NOTE

This manual is based on the English version of operating system. Illustrations, command names, window names, and similar information are from that version. Some items may differ from what you see on the computer screen, depending on which operating system you are using.

SPECIAL NOTICES

- The software and this Owner's Manual are the exclusive copyrights of Yamaha Corporation.
- Copying of the software or reproduction of this manual in whole or in part by any means is expressly forbidden without the written consent of the manufacturer.
- Yamaha makes no representations or warranties with regard to the use of the software and documentation and cannot be held responsible for the results of the use of this manual and the software.
- The company names and product names in this Owner's Manual are the trademarks or registered trademarks of their respective companies.
- The screen displays as illustrated in this Owner's Manual are for instructional purposes, and may appear somewhat different from the screens which appear on your computer.
- Future upgrades of application and system software and any changes in specifications and functions will be announced separately.
- Windows[®] is the registered trademark of Microsoft[®] Corporation.

The DME Audio System Network

In an audio system including one or more DME units and/or SP2060 units, the “control space” is logically organized using the concepts of “Area”, “Zone”, and “Device Group”. The space covered by the entire system is the “Area”, while independent sonic spaces within that Area are called “Zone”. A group of DME or SP2060 units assigned to the same function are considered a “Device Group”. An Area is comprised of one or more Zones, and each Zone can include up to 32 Device Groups. A single Device Group can include as many as 16 devices. Each Device Group has one “Group Master”.

NOTE

Meter response may deteriorate as the number of meters displayed in a single device group in DME Designer increases. In such cases meter response can be improved by dividing the device group. See “Zone Window” ([page 298](#)) for details on deleting devices from a device group.

NOTE

DME and SP2060 units cannot be combined in the same Device Group.

NOTE

All devices in a Device Group must be on the same subnet.

NOTE

A single device group cannot be controlled from multiple computers (multiple instances of DME Designer).

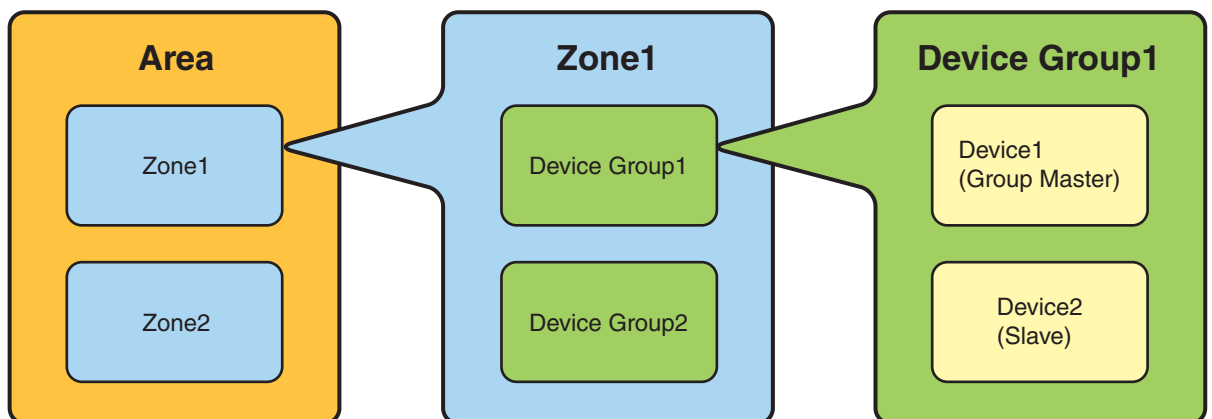

The DME Designer Software Application

The DME Designer software application provides a convenient, central interface for the creation and control of DME-based audio systems. By connecting the computer on which the DME Designer application is running to a Group Master it becomes possible to control multiple devices simultaneously. With DME Designer, DME audio systems can be designed and configured via a comprehensive block-diagram interface on the computer screen.

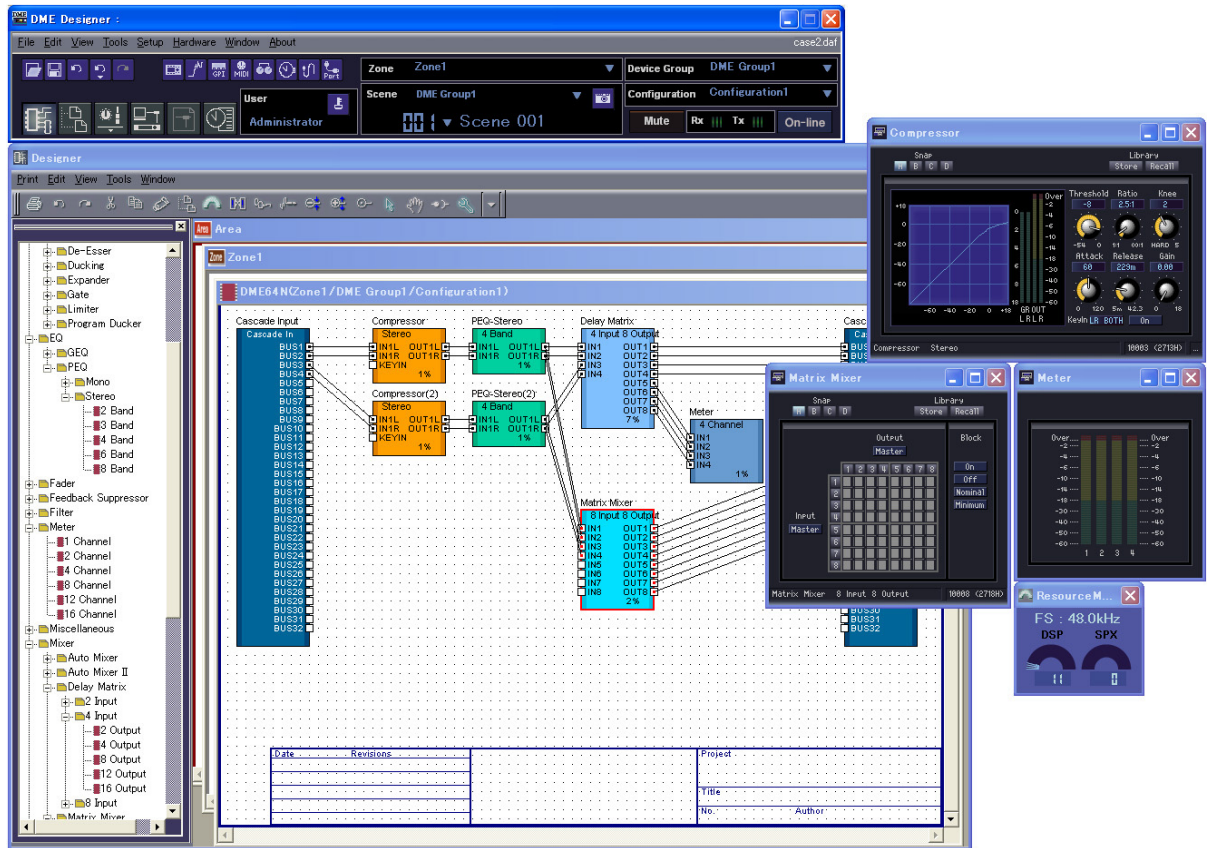

The main concepts used in the creation of DME audio systems are “Components”, “Configurations”, “Preset Parameters”, and “Scenes”.

■ Components

Any independent signal-processing block, such as an equalizer, compressor, input/output module, or external device control object is a “Component”.

■ Configurations

A “Configuration” is group of components, including their placement and interconnections.

■ Preset Parameters

The set of parameters for all components in a Configuration is know as the Configuration’s “Preset Parameters”.

■ Scenes

A Configuration and its Preset Parameters are a “Scene”.

Composition of scene

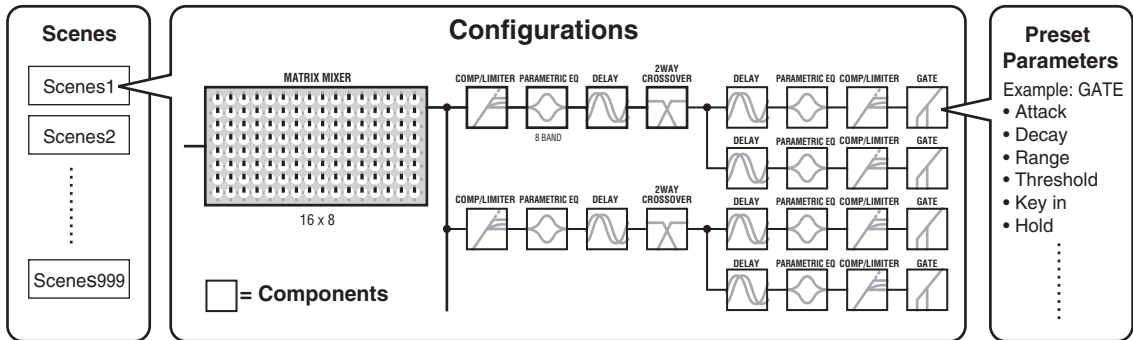

DME settings as well as Configuration and Preset Parameter settings are sent from the DME Designer application running on the computer to the Device Master via USB or Ethernet, allowing each device to function as a separate processor, independently from the computer. It is also possible to keep the DME Designer application on line and control the devices in real time.

It is possible to use the DME Designer to create Configurations that include multiple devices when the appropriate devices are connected.

Although it is possible to have multiple Zones in an Area, multiple Device Groups in a Zone, and multiple Scenes and Configurations in a Device Group, only one Area, Zone, Device Group and Configuration can be active and editable via the DME Designer at any one time. The active elements are known as the Current Zone, Current Device Group, Current Scene, and Current Configuration.

Data Handled by a DME Audio System

■ DME Data Structure

Common Overall Data	
Scene Link Settings	Settings required for linked scene operation between multiple groups.
Data for Each Device Group	
User Defined Button Settings	Settings required for component parameter control from the DME64N/DME24N or ICP1 panel. Up to 24 parameters can be registered for control.
Global Parameter Link Settings	Settings required for linked operation of the same types of parameters between multiple devices.
Data Used by the Scene Manager	
MIDI program Change Settings	Settings required to allow scene selection via MIDI commands.
Scenes	The information required to switch audio data processing setups. Scenes include configurations and preset data. The Scene Manager facilitates registration and management of scene data. Up to 999 scenes can be registered, and registered scenes are managed by their scene numbers.
Data for Each Device	
Configurations	A combination of the audio signal processing, audio input/output, and external device control components and their interconnections, created to create the desired audio system.
Local Parameter Link Settings	Settings that allow linked operation between similar types of internal DME parameters.
Component Link Settings	Settings that allow linked operation between similar types of internal DME components.
External Device Settings	Settings required to allow control of component parameters from external devices. Independent settings are required for each device. The external devices that can be used are as follows: <ul style="list-style-type: none"> • MIDI Controller (MIDI Control Change, Parameter Change). • GPI Controller. • DAW Controller. • AMX, Crestron, and other remote controllers. • PM5D or other compatible mixing console (controlling DME internal head amp)
Preset Parameters	The settings for the components in a configuration. Audio processing setups can be switched by changing the preset parameters. Components included in the preset parameter set are as follows: <ul style="list-style-type: none"> • GEQ, MatrixMixer, and other audio signal processing components. • Internal AD/DA (DME24N), Cascade (DME64N), and Mini-YGDAI card I/O components*. • Components for external devices such as the AD8HR and AD824 remote head amplifiers.
Wave file	Audio files to be played back by the Wav File Player.
File Storage	Project files and other file types can be stored.

* Some settings not included.

■ SP2060 Data Structure

Common Overall Data	
Scene Link Settings	Settings required for linked scene operation between multiple devices.
Data for Each Device	
Scenes	The information required to switch audio data processing setups. Scenes include configurations and preset data, The last Library name recalled is specified. The Scene Manager facilitates registration and management of scene data. Up to 99 scenes can be registered for 12 preset areas and 87 user areas, and registered scenes are managed by their scene numbers.
Configurations	A combination of the audio signal processing, audio input/output, and external device control components and their interconnections, created to create the desired audio system.
Local Parameter Link Settings	Settings that allow linked operation between similar types of internal SP2060 parameters.
Preset Parameters	The settings for the components in a configuration. Audio processing setups can be switched by changing the preset parameters. Preset parameters can be recalled by SP2060 units, but not edited.
Data for Each Component	
Library	Settings specific to the speakers to be used. In addition to the preset data provided, settings can be created by the DME Designer.

■ One DME unit/Device Group

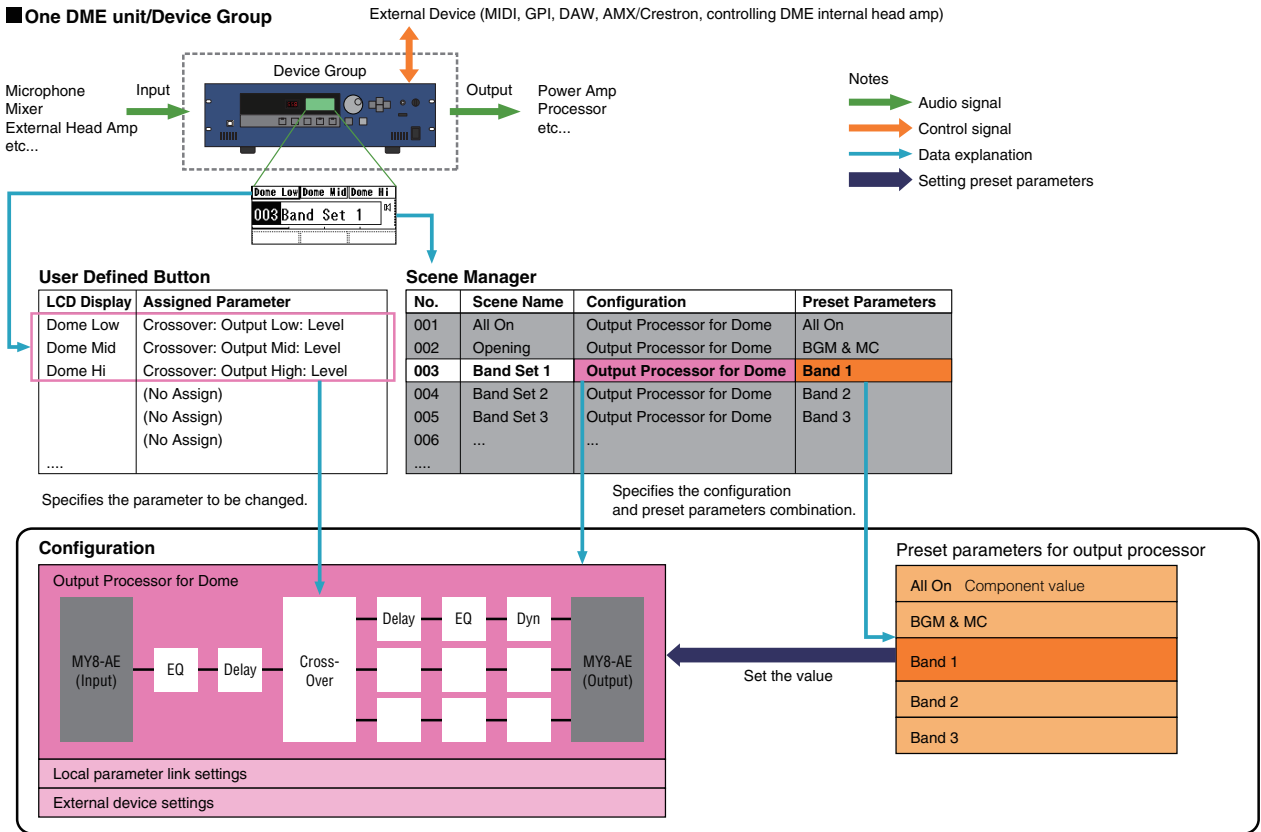

■ Two DME units/Device Group (When one DME unit doesn't provide sufficient processing power, up to 16 DME units can be used)

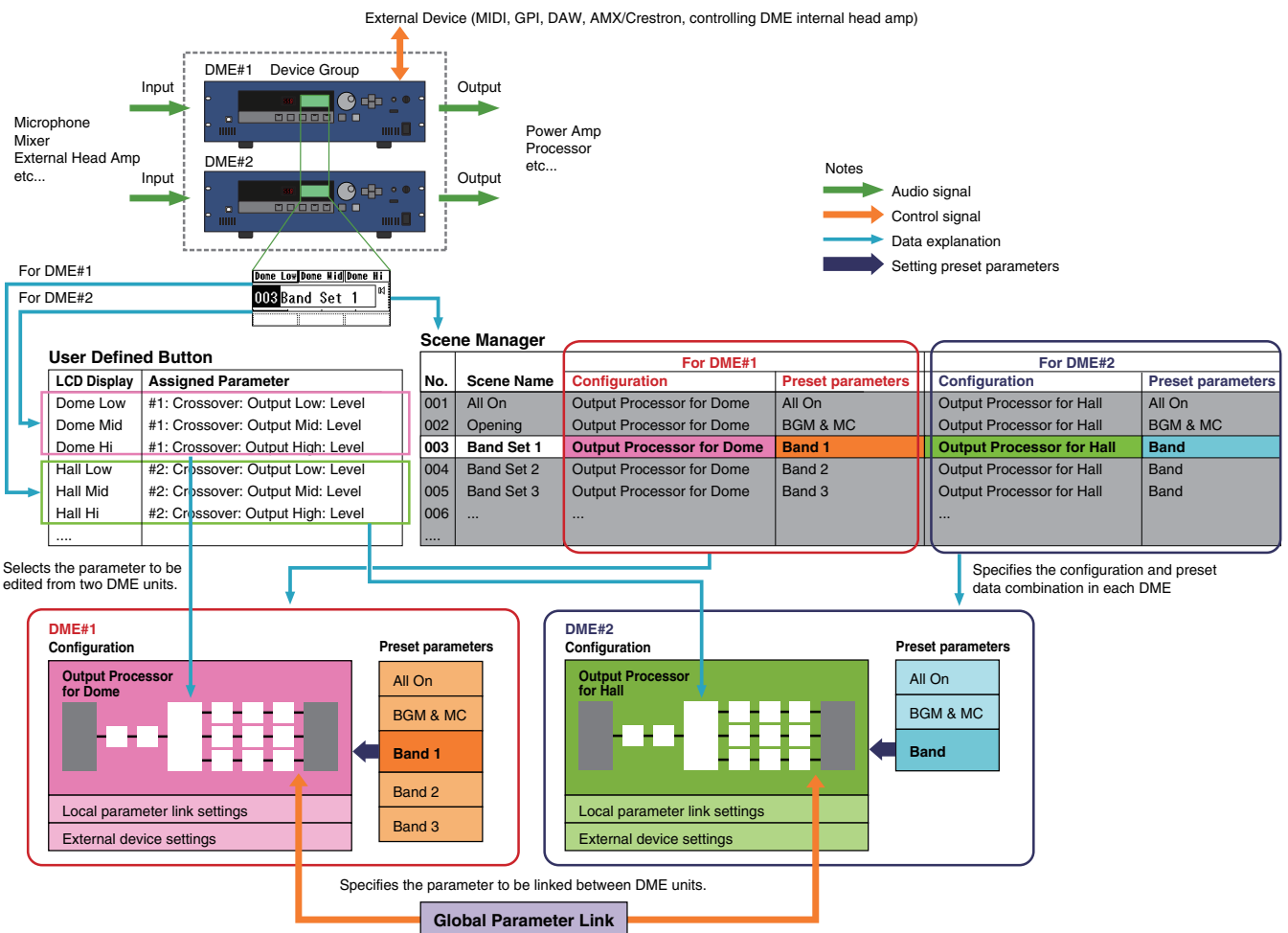

NOTE

Separate SP2060 units normally handle scenes independently, but the Scene Link function can be set from the DME Designer to allow linked scene operation. See "Scene Link Manager" on [page 151](#).

Main Changes from V1.0 to V1.1

■ Main Panel Window

- Instead of the former Parameter Link function, there are now two functions: a Global Link function that links parameters within all DMEs in a zone and a Local Link function that links parameters within a single DME unit. ([page 94](#))
- The Synchronization function can now not only send data from DME Designer to the DME unit, but can also synchronize by reading data from the DME unit. ([page 97](#))
- Scene Increment/Decrement and Time Adjustment can now be assigned in the GPI input function. ([page 114](#))
- DME unit events can now be recorded by the Event Logger function and displayed in the Event Logger window. ([page 177](#))
- The time for executing an event can now be set by using the Event Scheduler function. ([page 139](#))
- Parameters in the current configuration can now be listed on the display and printed out by using the Parameter List function. ([page 144](#))
- The Wav File Manager can manage Wave files played by the Wav File Player. ([page 151](#))
- Settings can be made by the DAW Control function that are used for controlling DMEs from a DAW controller. ([page 157](#))
- DME unit data can now be saved as a backup file by using the Backup function. ([page 157](#))

■ Designer Window

- The port name display can now be switched between long name display and short name display. ([page 206](#))
- DME64N cascade connections can now be set. ([page 221](#))
- Priority items can now be set when compiling configurations by using the [Compile Priority] function in the “Preferences” dialog box. ([page 220](#))
- Delay time can now be displayed for each component by using the Show Signal Delay function. ([page 305](#))
- Monitoring points can now be edited by using the “Monitoring Point List” dialog box. ([page 306](#))
- The status of connections in a configuration can now be analyzed in advance by using the Analyze function, without connecting the DME unit. ([page 308](#))
- You can now set the action that occurs when you double-click a user module object. You can also turn user module security ON or OFF, and set a password. ([page 246](#))
- Libraries with component parameters saved in them can now be recalled from the context menu for a component object. ([page 236](#))
- A new rule for wiring prohibits connections to terminals that would short the terminator.

■ Component Editor/Component

- A status bar has been added to the component editor. It displays the component name, component ID, and parameter IDs for parameters that are being edited. ([page 320](#))
- A Snap function has been added that records parameters in the editor temporarily. Parameter sets can then be switched by using the Snap buttons. ([page 362](#))
- The meter’s peak hold function can now be turned ON or OFF. ([page 359](#))
- A Wav File Player component has been added for playing Wave files. ([page 430](#))
- An effect component called SPX has been added that supports many different effect applications, such as reverb, delay, and modulation effects, along with complex combinations of multiple effects. ([page 471](#))
- A Slot Out component editor has been added. ([page 488](#))
- An Undo/Redo function is now available when using the design mode. It can undo the most recent operation (control movement/resize/deletion).

Changes from V1.1 to V1.2

■ Main Panel Window

- The synchronization algorithm has been refined for faster synchronization.
- Synchronization now can be executed from DME to DME Designer without any break in the sound.
- In the following cases, synchronization can be executed from DME Designer to DME without any break in the sound:
The second or later synchronization after starting DME Designer* and when differences in data between the DME and DME Designer are limited to parameters within components, AD824/AD8HR/DME24N AD/DA setting data, or Mini-YGDAI card setting parameters.
* If the file was saved when DME Designer was closed, there will be no break in sound even in the first synchronization after saving.
- Compile speed has been increased.
Up to three times faster when AutoDelayCompensation is turned On.
Up to two times faster when AutoDelayCompensation is turned Off.
- Synchronization is possible when no Mini-YGDAI card or a different Mini-YGDAI card is installed in the DME unit (a confirmation message will appear).
- An option to automatically close the dialog after synchronization has been added. (page 99)
- A progress bar has been added to the Synchronization dialog. (page 51)
- A message appears to warn when synchronization will cause muting.
- The following operations can be performed while on line:
 - Scene storage.
 - Scene name changes.
 - Fade ON/OFF and Fade Mode changes.
 - Fade time changes.
 - Parameter link setting changes.
- When a scene store is executed, that scene becomes the current scene.
- Wave files can be saved as DME data files, and are included in import/export operations. (page 44)
- Wave files can be saved in the Wav file library.
- Event Log events can be output via GPI. (page 79)
- The on-line indicator appears as a button which can be used to switch between on-line and off-line. (page 59)
- Scene edits cause the EDIT indicator to appear. (page 57)
- An auto file save function (Auto Save, post synchronization) has been added. (page 73)
- Different zones can be specified for use by different users. (page 158)
- Scene parameters related to User Defined Button, Program Change, GPI In and GPI Out can be set via the Scene Manager. (page 82)
- [Select All] and [Clear All] buttons have been added to the Scene Manager Recall Safe dialog box. (page 86)
- User Control can be created for individual users as well as security levels. (page 91)
- A Remote Control Setup List has been added. (page 139)
This list can be used to make detailed settings for a new software protocol that allow the DME to be controlled from AMX, Crestron, and similar devices.
Refer to the “DME-N Remote Control Protocol Specifications” document for details about the communication protocol. Information about the “DME-N Remote Control Protocol Specifications” document can be found at the Yamaha pro Audio website (URL below).
<http://www.yamahaproaudio.com/>
- It is possible to specify whether listed events will be executed by the Event Scheduler. (page 139)

- The order of same-time events can be changed in the Event Scheduler. ([page 139](#))
- Exceptions can be specified for Event Scheduler execution day/time. ([page 107](#))
- Event Scheduler execution times can be specified in 1-second increments. ([page 106](#))
- Head amp gain and Mini-YGDAI Card can be set via GPI, MIDI, User defined Button, DAW Control.
- Parameter values, scene recall, GPI output, Wave file playback, and head amp gain can be set via the User Defined Buttons. ([page 132](#))
- The Component Lock function dialog is separate from the Parameter List dialog. ([page 150](#))
- Shortcuts can be freely set as required. ([page 156](#))
- Files can be saved in the DME unit. ([page 70](#))
- A [Close All Editor Windows] button has been added to the Window menu. ([page 69](#))
- External head amp parameters will be recognized by the DME unit when either the DME or the external head amp (AD824, AD8HR) are turned on. Execute a scene recall to send DME settings an external head amp.
- This manual is now separate from the DME Designer installer, and can not be accessed from the DME Designer menus.

■ Designer Window

- The following operations can be carried out via the shortcut keys.
 - Navigator
 - Activate Navigator
 - Activate Toolkit
 - Activate Design Window
 - Select Left Port and Start Wiring
 - Select Right Port and Start Wiring
 - Wire Auto Single to Right
 - Wire Auto Multi to Right
 - Wire Auto Single to Left
 - Wire Auto Multi to Left
 - Delete Wire
- It is now possible to simultaneously edit multiple objects of the same type.
Example: Change the thickness or color of multiple wires at once.
- Files related to user modules (user module files, library files, user module editor files) can be combined and exported/imported as a single file.
- Port colors can be independently specified for each port type. ([page 219](#))
- Default wire thicknesses and types can be independently specified for each port type.
- An automatic hot-spot connection function has been added. ([page 285](#))
- Port display has been added to External Device, Picture, DME, and ICP1 objects.
- When drawing wires the keyboard cursor keys can be used to move the mouse cursor, and the <Enter> key can be used to create nodes.
- When drawing wires <Shift> key plus <→> key and <Shift> key plus <←> key combinations can be used to automatically connect horizontally-aligned hot spots.
- DME object ports can be freely specified.
- Compilation of configurations with loop connections is possible when Auto Delay Compensation is On.
- The name has been changed from “Foot Monitor” external device to “Floor Monitor.”
- Addition External Device types have been provided.
- External Devices can be double-clicked to open a file saved by other applications. ([page 233](#))
- Picture objects can be double-clicked to open a specified editor. ([page 249](#))
- Text objects can be double-clicked to open a specified editor. ([page 252](#))

- User module port labels can be edited. (page 246)
- Graphics can be placed to represent user modules. (page 247)
- The Legend field automatically resizes to accommodate project names and titles of different lengths.
- A Generic “MY-Others” setting has been provided to accommodate third-party Mini-YGDAI cards.

■ Component Editor Window

- Undo and Redo are now shortcut compatible.
- A scroll bar appears when the size of the component editor window is reduced.
- The size and position of the component editor window are memorized.
- An option to allow mouse-over zooming of the edit box has been added. (page 323)
- A [Back] button that allows switching between related parent and child windows has been added. (page 320)
- A [Close All Editor Windows] button has been added to the contextual menu.
- Source Selector, Speaker Processor, Limiter, Slot In, Cascade In, and Cascade Out components have been added.
- The Delay algorithm has been revised. (page 399)
 - LEVEL and MUTE are effective when Delay is Off for each channel.
 - The name of the overall Delay [On] parameter has been changed to [All Bypass].

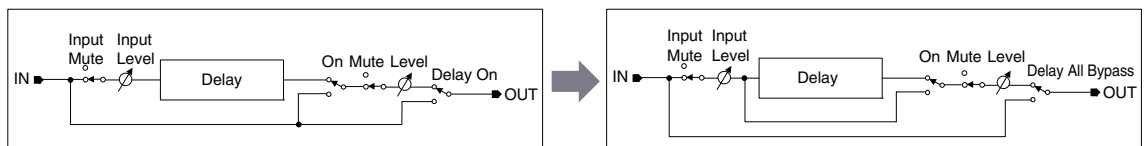

- The bus send level range for Delay, Matrix, and Matrix Mixer components has been changed to $-\infty$ through 0.0 dB.
- Snap copy is possible. (page 363)
- Snap can be retained until the application is quit or another file is opened.
- Security status is displayed in the user module editor status bar.
- Multiple controllers can be selected by clicking while holding the <Ctrl> key when the editor is in the design mode. (page 337)
- [Picture], [Text], [Box], [Ellipse], and [Frame] have been added to the tool palette of the user module editor and user control editor design mode. (page 325)
- Controller properties can be accessed by double-clicking controllers in the user module editor or user control editor design mode. (page 344)
- Picture and Text objects can be clicked to open a specified editor in the user module editor or user control editor.
- The User Module Editor and User Control Editor offer a greater range of customization options for color, size, etc., of the placed controls.

■ MIDI Setup

- A MIDI Setup minimize function has been added.

■ V1.2 Precautions

- When using project files (*.daf) created by version 1.1.5 or earlier, synchronize from the DME Designer to the DME unit for the first synchronization.
- Project files (*.daf) created using version 1.2 will not open properly on version 1.1.

Changes from V1.2 to V2.0

■ General

- Support added for DME8i-C/DME8o-C/DME4io-C, SP2060 units and MY16-CII.
- “Device Groups”, or groups of the same type of device, have been added at the lowest Zone level.
- It is now possible to have one master device per device group rather than one master device per zone. This means that it is possible to have multiple master devices in a single zone.
- Group masters can now be assigned regardless of the IP address. This makes it possible to have multiple device groups at a single network address.
- Configurations can be created and deleted for each device group.

■ Component

- A Feedback Suppressor component has been added. ([page 419](#))
- The Speaker Processor component PEQ “Q” parameter now goes to “63”. ([page 464](#))

■ Main Panel Window

- Firmware and component data can now be updated simultaneously. ([page 186](#))
- A Recovery Update function that allows recovery from program corruption has been added. ([page 188](#))
- A Component Link function that allows simultaneous linking of all component parameters has been added. ([page 94](#))
- Scene Link function that allows simultaneous control of multiple devices in different device groups has been added. ([page 151](#))
- A Protect function has been added to the scene manager. ([page 82](#))
- Card settings are no longer included in scene data.
- A Utility window has been added to allow editing of device utility settings. ([page 167](#))
- The Local Parameter Link display order has been changed. ([page 94](#))
- Parameter Link operation can now be turned on or off for each device group. ([page 94](#))
- Compilation and analysis is now possible even if no connections have been made.
- Navigator window hide/show can now be selected from the main window.
- The Event Logger can now display only the event data for a specified device. ([page 75](#))
- The GPI terminal names have been changed from [CH] to [PORT].

■ Designer Window

- A hand tool for window movement has been added. The hand tool can be selected via the hand/arrow icon in the toolbar, or from the [Tools] menu. The hand tool can also be temporarily selected by holding the spacebar on your keyboard.
- Window magnification and reduction can now be controlled via the mouse wheel while holding the keyboard “Ctrl” key.
- Horizontal scrolling can be controlled via the mouse wheel while holding the keyboard “Shift” key.
- The Edit Mode on/off can now be changed from the tool bar. ([page 192](#))
- Scene information now appears in DME objects, and the Scene Manager can be launched from the scene information display. ([page 82](#))
- An [On-line] button has been added to DME objects, and synchronization is now possible. ([page 59](#))
- Sampling frequency display has been added to the resource meter window. ([page 196](#))
- Sampling frequency display has been added to the configuration window status bar. ([page 301](#))
- The sampling frequency is now displayed during analysis.

- Double-clicking the component name now opens the properties window.
- Organization of the Tool Kit window has been changed. (page 198)
- A [Draw Image] checkbox that displays or hides the worksheet background image file has been added to the Sheet properties. (page 263)
- [Configuration Manager] has been added to the contextual menu that appears when a DME or SP2060 object is right-clicked. (page 217,page 226)
- [Recall Component Library] and [Store Component Library] now appear in the contextual menu that appears when a component is right-clicked, even when the Edit Mode is OFF.
- The Compile Settings can now be edited for each DME unit. (page 220)
- Only one Zone window is now provided for multiple configurations.
- The [Export DXF] and [Preferences] commands have been moved from the [Print] menu to the [Tools] menu.
- [Configuration] has been changed to [Configuration Manager] in the [Tools] menu.
- When [Prohibit Diagonal Connections] in the [Tools] menu is active it is possible to select 2 diagonal points and those points will automatically be connected by a combination of horizontal and vertical wires.

■ Component Editor Window

- A [Level Meter Enable] command that displays or hides the meter values has been added to the contextual menu. Hiding the meters can result in increased communication speed in some cases. (page 360)
- A [Display Order] function that allows the order of the controllers to be changed as required has been added to the User Control Editor and User Module Editor. (page 325)
- An [Add Component to Component Link] command has been added to the controller contextual menu.(page 360)
- The registered group is now displayed in the [Add Parameter to Parameter Link] submenu of the contextual menu of controllers registered for Parameter Link operation.(page 368)
- Increased speed when selecting and dragging a large number of controllers in the User Control Editor and User Module Editor
- It is now possible to switch from the Navigator window to Zone display while online.

■ V2.0 Precautions

Please use DME Designer V2.0 with DME64N/24N V2.0 or later, DME8i-C/DME8o-C/DME4io-C V2.0 or later, and SP2060 V1.1 or later.

See the Yamaha Pro Audio website for compatibility details (<http://www.yamahaproaudio.com/>). When DME64N/24N and DME8i-C/DME8o-C/DME4io-C are used together in the same device group, faster communication speed as well as smoother DME Designer meter display can be obtained by assigning a DME8i-C/DME8o-C/DME4io-C unit as the device group master.

Changes from V2.0 to V3.0

■ General

- DME8i-ES/DME8o-ES/DME4io-ES support.
- The DME Designer and DME-N Network Driver installers have been combined, so the appropriate DME-N Network Driver version is now installed automatically with the DME Designer application.
- The following connections to the Slave DME units are now possible when a DME Satellite unit is assigned as the Device Group Master:
 - USB/Ethernet connection to the computer (DME Designer).
 - Cascade connection to control from the PM5D console (DME64N only).

■ Component

- Ambient Noise Compensator component added ([page 379](#)).
- Audio Detector component added ([page 381](#)).
- Auto Gain Control component added ([page 382](#)).
- Auto Mixer II component added ([page 431](#)).
- Simple Mixer component added ([page 450](#)).
- Room Combiner component added ([page 460](#)).
- Matrix Mixer and Router component variations added.

■ Main Panel Window

- To allow project information to be easily reproduced on a different computer, it is now possible to export and import all necessary files at once, rather than only project files with the “.daf” extension ([page 45](#)).
- A Device Information window that lists the status of all devices has been added ([page 190](#)).
- It is now possible to individually set each user control to determine whether it will open automatically when the project file is opened ([page 91](#)).
- In accordance with the above change, the Startup User Control item has been removed from the Security dialog box.
- It is now possible to assign Direct Parameter Value to the GPI input function, and assign Direct Parameter Value and Audio Detector to the GPI output function ([page 112](#), [page 122](#)).
- An option that automatically saves the project file (.daf extension) in the DME unit when going online has been added ([page 98](#)).
- It is now possible to control internal DME-24N/DME8i-C/DME4io-C/DME8i-ES/DME4io-ES head amps from a PM5D or other compatible mixing console ([page 141](#)).
- Remote control from AMX, Crestron, and similar controllers is now possible via Ethernet connection only for DME Satellite units. ([page 171](#)).
- The display format of the parameter values displayed in the Remote Control Setup List and Parameter List dialog box can now be switched between the internal settings and the values displayed in the editor windows ([page 139](#), [page 147](#)).
- The Event Logger window can now display additional error messages shown on the DME display panel ([page 80](#)).
- It is now possible to set the DME unit so that the internally stored event log is not erased ([page 77](#)).
- Improvements have been made to the additional error message information shown in the Event Logger window.
- The DME unit internal clock and DME Designer time display now support daylight saving time (DST) ([page 180](#)).
- Firmware updates can now be applied to entire device groups, for improved speed and efficiency.

■ Designer Window

- It is now possible to set a “clear” background color for text, box, and ellipse objects ([page 252](#), [page 254](#), [page 256](#)).
- Password entry is now required when opening a User Module Properties dialog box or saving/exporting in a user module to which security has been applied.
- Linked software applications can now be launched from the Slot component contextual menu ([page 240](#)).
- User module templates that use the same library are now categorized and displayed as user module groups ([page 310](#)).
- Image files are now included in User Module exports.
- Component and parameter links can now be copied when DME objects, components, and user modules are copied/pasted or duplicated.
- Parameter links are now saved when User Module data is saved/exported.
- When already-placed picture files are replaced, they will be updated and displayed correctly without the need to restart the DME Designer application.

■ Component Editor Window

- [Line] and [Scene Recall] tools have been added to the User Module Editor and User Control Editor design modes, allowing placement of lines and scene recall buttons ([page 332](#)).
- In the User Module Editor and User Control Editor it is now possible to convert placed sliders to knobs, and vice-versa ([page 343](#)).
- More options are available for customizing the controls listed below in the User Module Editor and User Control Editor:
 - A property dialog box has been added for sliders, allowing customization of direction, scale, color, size, and other parameters ([page 345](#)).
 - Level meter size can be customized ([page 347](#)).
 - A property dialog box has been added for slider level meters, allowing customization of direction and size ([page 348](#)).
 - Knob color and knob background color can be customized ([page 344](#)).
 - Text background color can be customized ([page 352](#)).
 - A property dialog box has been added for indicators, allowing customization of color and size ([page 348](#)).

■ V3.0 Precautions

Use DME Designer V3.0 only with DME64N/24N V3.0 or later, DME Satellite V3.0 or later, and/or SP2060 V1.2 or later. Refer to the Yamaha Pro Audio website (<http://www.yamahaproaudio.com/>) details on combinations.

When combining DME64N/24N and DME Satellite units in a device group, be sure to assign a DME Satellite unit as the device group master. Synchronization cannot be performed if a DME64N/24N is assigned as the device group master.

When using the Windows Vista operating system, use only USB-MIDI Driver V3.0 or later, and DME-N Network Driver V1.2 or later.

Changes from V3.0 to V3.5

■ Component

- Program Ducker component added ([page 412](#)).
- (V3.5.1) During installation it is possible to select and install speaker library data for third-part speakers into the Speaker Processor component library.

■ Main Panel Window

- MIDI Setup has been discontinued. Communication ports can now be directly selected via the [Setup] menu [Communication Port] item. ([page 155](#))
- (V3.5.1) [SP2060 Backup] has been added to the main panel window [Hardware] menu, allowing internal SP2060 data to be transferred to a computer for backup. Multiple SP2060 units can be restored from the backup data. ([page 184](#))

■ Designer Window

- Improvements in the compiler algorithm achieve greater DSP resource utilization efficiency. ([page 98](#), [page 305](#), [page 308](#))
- MY16-ES64, MY16-EX, and MY16-MD64 I/O cards can now be specified for slot installation.
- The TX6n/TX5n/TX4n, ACD1, SB168-ES, IMX644, IPA8200, and NEXO products can now be specified as external devices. V3.5.1 adds the IM8, MSR250, and other devices.
- When cascade connecting DME64N units across device groups, unit numbers are automatically assigned when a connection is made between the [CAS IN] and [CAS OUT] terminals in the Zone window.

■ Others (Firmware V3.09 changes)

- When controlling DME units remotely from a PM5D using the DME Control function, it is now possible to set an ID number other than “2” for the group master DME unit. In this case the PM5D firmware must be updated to V2.20 or later.
- It is now possible to replace the default DME64N/24N startup screen (normally the model name) with an original graphic file. ([page 71](#))

■ V3.5 Precautions

Use DME Designer version V3.5 with DME64N/24N or DME Satellite units running firmware version between V3.0 and V3.8, and SP2060 units running firmware version V1.2 or later. Refer to the Yamaha Pro Audio website (<http://www.yamahaproaudio.com/>) details on combinations.

When combining DME64N/24N and DME Satellite units in a device group, be sure to assign a DME Satellite unit as the device group master. Synchronization cannot be performed if a DME64N/24N is assigned as the device group master.

When using the Windows Vista operating system, use only USB-MIDI Driver V3.0 or later, and DME-N Network Driver V1.2 or later.

When using the Windows 7 operating system, use only USB-MIDI Driver V3.0.4 or later, and DME-N Network Driver V1.2.1 or later.

Changes from V3.5 to V3.8

■ New Features

- The DME64N/24N (V3.8x or later) can now be controlled via Ethernet connection from certain external control devices.
- The DME64N/24N (V3.8x or later) can now be assigned as the device group master when the device group is formed by combining the DME64N/24N (V3.8x or later) and the DME Satellite.
- A new [Show Unconnected Node] button which displays unconnected nodes has been added into the Designer window toolbar.
- The window sizes of User Control Editor/User Module Editor can now be enlarged more than the display resolution of computers. When a size is set that is larger than the display resolution of computers in the “User Control Editor Settings” dialog box which can be selected in the context menu, a scroll bar is displayed.
- New library data has been added into the Preset Library of the Speaker Processor.
- The following devices can now be set for the external devices: M7CL-48ES, DSR series, S5, NS-AW series, NS-IC series, KMS-710, CD-S300RK, CD-C600RK, Gooseneck Microphone and Boundary Microphone.

■ Changes

- The layout of the Remote functions and MIDI functions have been changed through revisions of the operation of the Utility dialog.

■ Fixed Bugs

- Fixed problems in which the Remote Control settings were not applied to the DME Designer appropriately when synchronizing.
- Fixed a problem in which the meter laid out in User Control might not move.
- Fixed a problem in which the window might not be displayed when the external display status was changed.
- Fixed a problem in which the parameters of both Recall Safe and Global Link, might not be displayed appropriately when Scene Recall was executed.

■ V3.8 Precautions

- Use DME Designer version V3.8.0 with DME64N/24N or DME Satellite units running firmware version V3.0 or later, and SP2060 units running firmware version V1.2 or later.
- Use the latest DME Designer to update the DME firmware to the latest version.
- DME Designer cannot be used to update firmware version 3.5 or earlier to version 3.8 or later, or to downgrade from version 3.8 or later to version 3.5 or earlier (this does not apply to the SP2060 or ICP1). Contact your Yamaha dealer.
- Save an up-to-date DME project file (*.daf). Don't update unless an up-to-date “.daf” file has already been saved on your computer. Without the “daf” file, you will not be able to restore DME operation.
- When DME64N/24N units running firmware version 3.5 or earlier and DME64N/24N or DME Satellite units running firmware versions 3.8 or later are combined in the same device group, DME64N/24N units running firmware version 3.5 or earlier cannot be designated as the group master.
- If the Program Ducker component is used, both DME firmware and DME Designer versions must be V3.5 or later.

Changes from V3.8 to V4.0

■ New Features

- The MY4-AEC card can now be selected for I/O card slots. AEC components, which are available when the card is installed, have been added.
- The “Partial Recall” function has been added. Scenes can now be recalled on a per component basis. By utilizing both Recall Safe and the new Partial Recall functions, components to be recalled or not recalled can now be selected precisely.
- Configurations can now be duplicated in the “Configuration Manager” window.
- In the Main Panel window, configuration names are now displayed, and configurations may be selected.
- The VS4, VS6, and NS-IC600 can now be specified as external devices.

■ Changes

- The Remote V3.5 tab and the MIDI V3.5 tab in the “Utility” dialog box have been deleted.
- The [Cancel] button has been added in the “Project File has been modified. Save?” dialog box which is displayed before closing DME Designer to cancel closing procedure.

■ Fixed Bugs

- Fixed a problem in which SP2060 configurations could be edited when the “Configuration Manager” dialog box was opened via [Tools] menu [Configuration Manager] item.
- Fixed a problem in which configurations could be edited while online when the “Configuration Manager” dialog box was opened via the context menu displayed by right clicking a DME object in the Designer window.
- Fixed a problem in which the compiling procedure would occasionally complete successfully even though an error should occur when an IN port was connected to multiple OUT ports.
- Fixed a problem in which the compiling procedure would occasionally not complete when compiling was executed on a complex configuration with multiple SPX components.
- Fixed a problem in which the compiling procedure would occasionally not complete when compiling was executed on a complex configuration having an SPX component with an output connected to any other component.
- Fixed a problem in which the [+48V Master] indicator didn't light in the AD8HR component editor.
- Fixed a problem in which DME Designer could occasionally freeze when closing the application by means other than clicking [Exit] in the [File] menu of the Main Panel window.
- Fixed a problem in which parameter links remained functional for parameters of different types which should not be linked after the effect type was changed for an SPX component having linked parameters.
- Fixed problems in which Scene Store and Recall functions might not work when Parameter Link settings were no longer appropriate due to editing the Configuration.

■ V4.0 Precautions

- Use DME Designer V4.0 with DME64N/24N or DME Satellite units running firmware V4.0 or later, and SP2060 units running firmware V1.2 or later.
- Use the latest DME Designer to update the DME firmware to the latest version.
- DME Designer V4.0 cannot be used to update firmware V3.5 or earlier to V4.0 or later, or to downgrade from V4.0 or later to V3.5 or earlier (this does not apply to the SP2060 or ICP1). Contact your Yamaha dealer.
- The DME firmware V3.8 can be updated to V4.0 using DME Designer V4.0.

Contents

Getting Started with DME Designer	2
SPECIAL NOTICES.....	2
The DME Audio System Network	3
The DME Designer Software Application	4
Data Handled by a DME Audio System	6
Main Changes from V1.0 to V1.1.....	10
Changes from V1.1 to V1.2	11
Changes from V1.2 to V2.0	14
Changes from V2.0 to V3.0	16
Changes from V3.0 to V3.5	18
Changes from V3.5 to V3.8	19
Changes from V3.8 to V4.0	20

Chapter 1 Before Using 23

Installing DME Designer.....	23
Starting DME Designer.....	23
Closing DME Designer.....	25

Chapter 2 DME Designer Overview 26

Names and Functions of the Windows.....	26
Users and Security.....	31
Files Used by the DME DESIGNER.....	34
Configuration Creation Procedure.....	49
Online	50

Chapter 3 Main Panel Window 54

Names and Functions of the Windows.....	54
Main Panel Window Menu	60
DME File Storage.....	70
Preferences	72
Event Logger	75
Scene Manager	82
User Control	91
Parameter Link	94
Synchronization (DME Designer and Unit Synchronization).....	97
Event Scheduler	101
Wav File Manager.....	108
GPI.....	112
MIDI	125
User Defined Button (User Defined Parameters).....	132
DAW Control.....	136
Remote Control Setup List.....	139
Internal HA Control.....	141
Parameter List	147
Component Lock.....	150
Scene Link Manager	151
SP2060 Library Manager.....	153
Communication Port Setup.....	155
Shortcut Keys	156
Security (Creating Users and Making User Settings)	157
Network Setup.....	165
Utility.....	167
Word Clock.....	177
Monitor Out.....	179
Clock	180
Language Settings	182
Backup	183

SP2060 Backup.....	184
DME Firmware Update	186
Device Information	190

Chapter 4 Designer 192

Editing Configurations.....	192
Designer Window	193
Toolkit Window	198
Designer Window Menu	203
Objects.....	210
Design Window Shared Settings and Operations.....	268
Drawing and Editing Wires.....	279
Adding, Deleting, and Renaming a Zone.....	291
Changing Device Groups.....	293
Adding, Deleting, and Renaming a Configuration	295
Area Window	297
Zone Window.....	298
Configuration Window	301
User Module.....	309

Chapter 5 Editor Window 319

Component Editor Window.....	319
User Control Editor/User Module Editor	325
Operation Mode and Design Mode.....	358
Context Menu	359
Snap	362
Library	364
Creating Parameter Links.....	368
Creating Component Links.....	370

Chapter 6 Component Guide 371

Types of Components	371
Ambient Noise Compensator	379
Audio Detector	381
Auto Gain Control	382
Crossover	383
Crossover Processor	387
Delay	399
Dynamics.....	402
Equalizer (EQ)	414
Fader	418
Feedback Suppressor.....	419
Filters	420
Meter	428
Miscellaneous.....	429
Mixer	431
Pan	453
Room Combiner	460
Router.....	461
Source Selector.....	463
Speaker Processor.....	464
SPX.....	471
AEC – Acoustic Echo Canceller (MY4-AEC card required) ..	482
Slot.....	487
Cascade (DME64N only).....	489
Analog Input and Output.....	492
SP2060 Input and Output.....	494
CobraNet Input and Output.....	495

EtherSound Input and Output	497
MY-Card	498
Remote Controlled Head Amp	503
Component Glossary.....	505

Appendix	509
-----------------	------------

Options	509
Main Display.....	511
Parameter Edit Displays.....	512
Utility Displays.....	516

Troubleshooting	521
------------------------	------------

Index	522
--------------	------------

Chapter 1 Before Using

Installing DME Designer

To use DME Designer, you must first install the software on the computer. Before you can connect the DME Designer software to the DME or SP2060 unit, you must first install the USB MIDI Driver or the DME-N Network Driver, according to how you will be connecting, and then make the appropriate settings.

For instructions about the installation and setup for the DME Designer and DME-N Network Driver, and about the installation for the USB-MIDI Driver, see the “DME Setup Manual.”

NOTE

Initial settings for DME Satellite units must be transferred via USB-MIDI, so it is necessary to properly install the USB-MIDI Driver.

Starting DME Designer

The DME Designer software is started from the [Start] menu. DME Designer is used with one user logged on. The user logs on when the software is started.

■ DME Designer Start Up and Logon (When Auto-Logon Is Not Set)

- 1 Click [Start] → [All Programs] → [YAMAHA OPT Tools] → [DME Designer] → [DME Designer].

The “Log On” dialog box will be displayed.

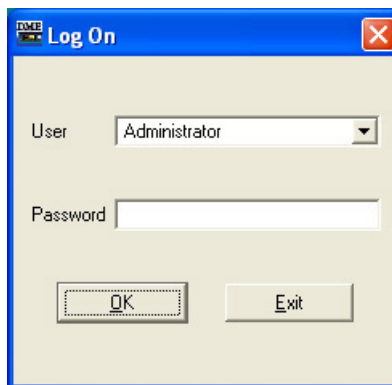

NOTE

Automatic log-on is the default setting. If the automatic logon feature is enabled, the “Log On” dialog box will not be displayed when the application is started. Instead, the auto-logon user will be logged on automatically. See [page 31](#) for information about auto-logon.

- 2 Click the [▼] at the right of the [User] box, and select the user.
If no user has been created, only [Administrator] will appear in the list. When starting DME Designer for the first time after installing, select [Administrator].
- 3 Enter the password into the [Password] box.
Enter the password set for the user.
If no password has been set, leave the password box blank when you log on.
- 4 Click the [OK] button.
DME Designer starts up.

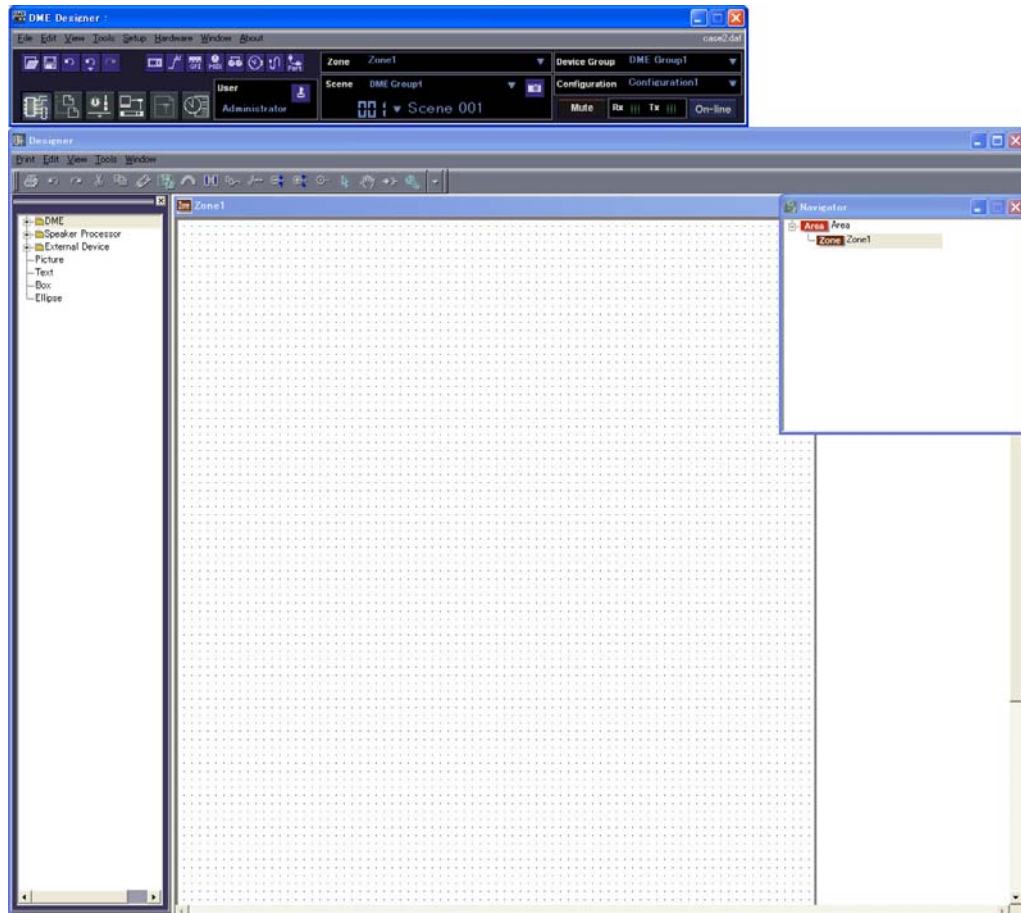

■ When Automatic Logon Has Been Set (page 31)

If automatic logon has been set, the “Log On” dialog box will not be displayed. The user set for automatic logon will be logged on.
With automatic log on, even if a password is set for a user, it will not be requested during log on. This is useful when logging on a specific user.

■ Starting by Opening a Project File

DME Designer starts when a project file with a saved configuration is opened. When the project file is opened, DME Designer is started with the window configuration that was in place when the file was last saved.

Closing DME Designer

To close DME Designer, click [Exit] on the [File] menu of the Main Panel window. It can also be closed by clicking the [Close] button on the Main Panel window.

1 Click [Exit] on the Main Panel window [File] menu.

When you try to close DME Designer, “Project File has been modified. Save?” will be displayed in a dialog box.

NOTE

Sometimes the “Project File has been modified. Save?” dialog box will not be displayed.

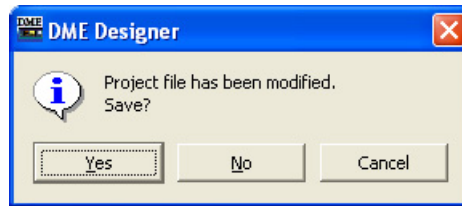

2 To save the file, click [Yes]. To close without saving, click [No]. To cancel the operation, click [Cancel].

If you click [Yes], the File Save dialog box will be displayed.

Chapter 2 DME Designer Overview

Names and Functions of the Windows

The DME Designer software has several windows, including the Main Panel window, Designer window, Component Editor window, Resource Meter window, and others.

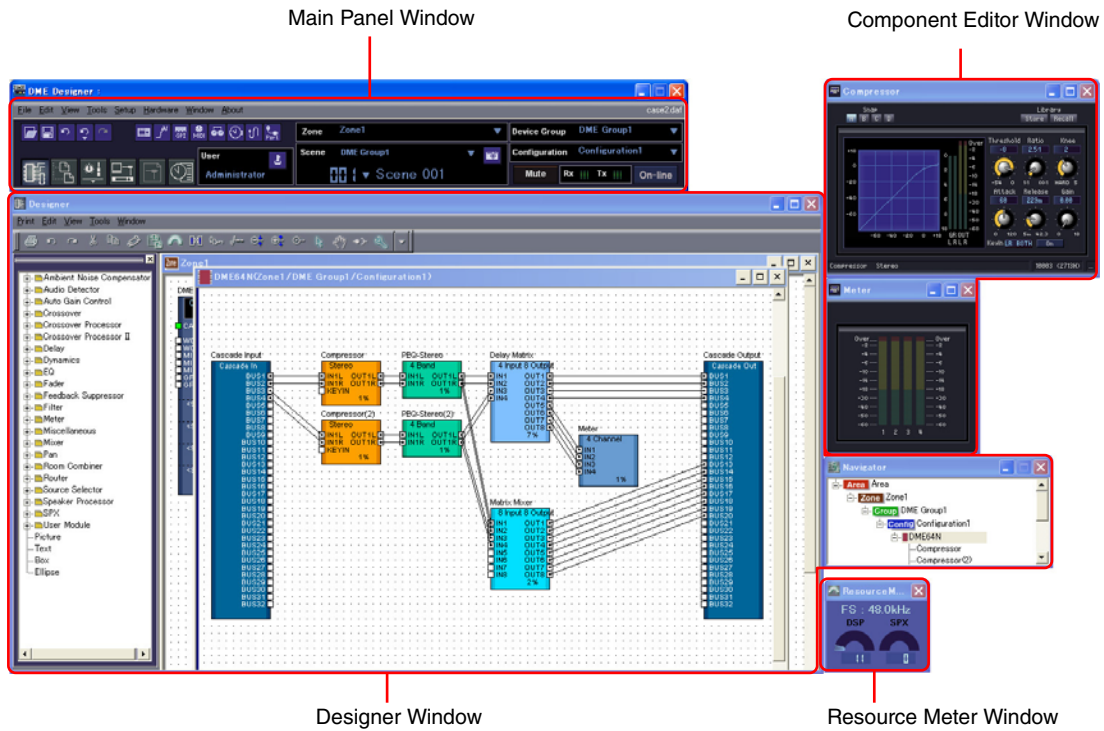

Main Panel Window

Menus and buttons are available in the Main Panel window. The current DME Designer environment, including the active zone, device group and scene the currently logged on user name, and the connection status to the DME unit are displayed on the right side of the Main Panel window.

Designer Window

The Designer window displays several different windows. First among them is the Area window, where you can manage the entire system. The Area window includes one or more Zone windows, which in turn include one or more DME or SP2060 units that are used to build a zones within the area. Next is the Configuration window, where you create the internal configuration of each DME or SP2060 unit. Within the Configuration window are the User Module windows, where you can assemble often-used components into templates the Toolkit window, which displays objects used in the other windows as the basic building blocks for sound designs; and the Navigator window, which lets you grasp the overall status of the system at a glance.

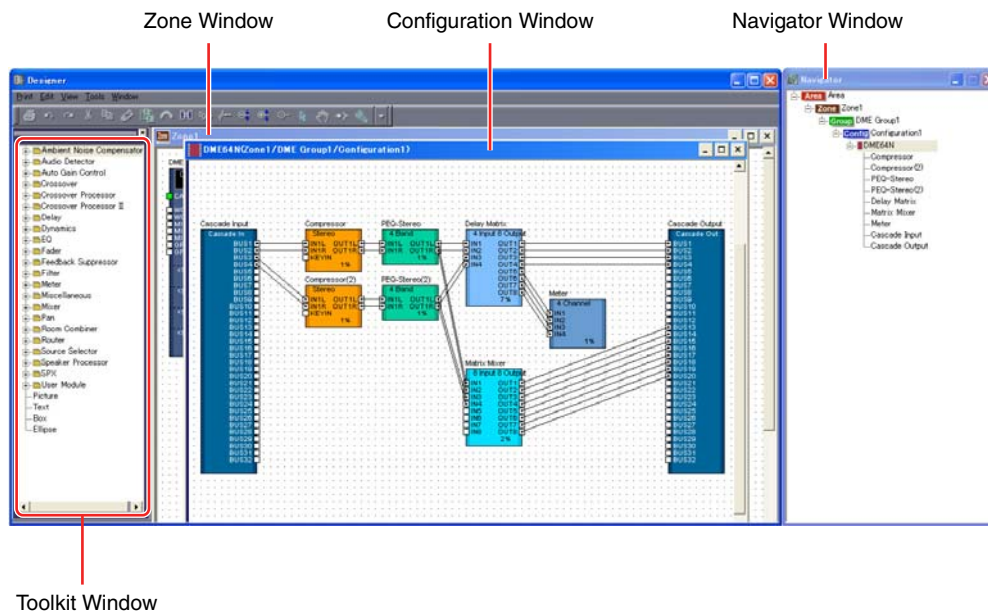

■ Area Window

The Area window is used for designing areas, which manage the entire system. While at least one zone is included within an area, multiple zones can be arranged there.

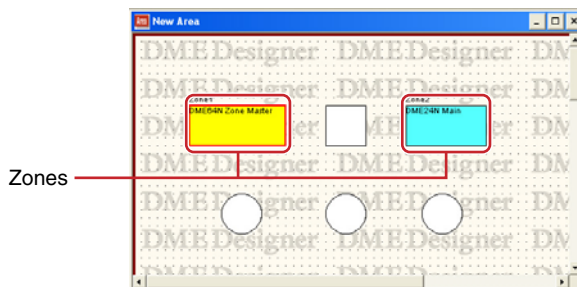

■ Zone Window

The Zone window is used to design zones within the area. A zone is a more concrete blueprint that includes at least one DME or SP2060. It shows the DME's connections with other devices and the wiring between them. You can create multiple zones.

The DME and SP2060 units and connected devices are arranged in each Zone window, creating configurations.

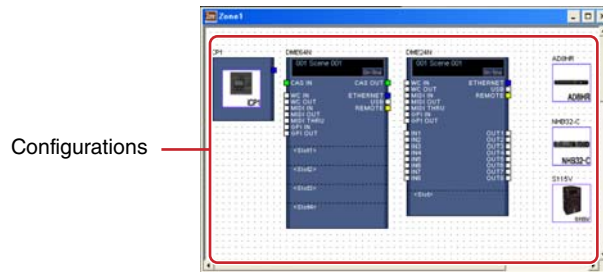

■ Configuration Window

The Configuration window is used to design the internal configuration of each DME unit contained in the Zone window. By arranging and connecting components in the Configuration window, you can create things like complex processors or matrix mixers, that determine the actual internal structure that operates each DME unit.

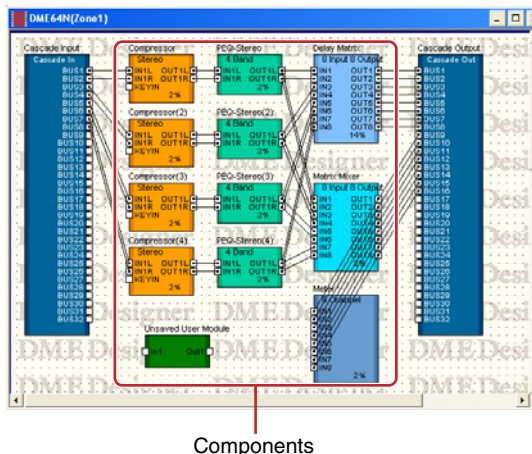

■ User Module Window

The User Module window is used for designing user modules that can be arranged in the Configuration window. You can create original modules by combining multiple examples of often-used components. When you save these modules as templates you can recall them easily whenever you want.

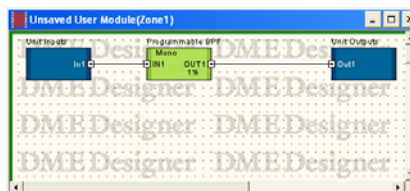

■ Toolkit Window

The Toolkit window displays the objects that you can use in each window that can be displayed in the Designer window. Those windows are the Area, Zone, Configuration, and User Module windows. The Toolkit displays different objects, according to the currently active window. To place an object in a window, double-click it in the Toolkit window where it is displayed or drag it to the currently active window.

■ Navigator Window

The Navigator window displays the area, zones, configurations, and components in a hierarchical fashion that lets you check their status as a whole. When editing offline, you can click an area name, zone name, or configuration name to make that window active. Clicking a component name will open the component editor window for that component.

■ Resource Meter Window

This window provides an indication of component usage for each DME unit currently placed in the Configuration window. The usage percentage increases as the number of components increases. The component usage percentage is shown in graph form for each DME unit.

The window appears simultaneously with the designer window, and can be used as a component usage guide while creating configurations. The sampling frequency for each DME unit is also displayed. Please note that the sampling frequency of the DME unit itself will also affect the usage percentage.

NOTE

In configurations that have a large number of connections, compilation might not be possible in some cases even if the resource meter reading is less than 100%. To determine whether compilation is possible we recommend using the “Analyze” dialog box (page 308) prior to actual compilation.

NOTE

This window is not displayed for SP2060 units.

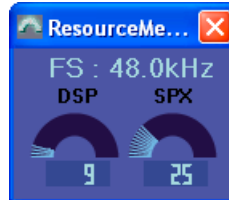

■ Objects and Components

“**Object**” is the name for the parts that are arranged in the various design windows, such as the Area, Zone, Configuration, and User Module windows. Objects are always laid out in the Toolkit window. Only the appropriate objects for each window are displayed. The blocks displayed at the higher level of the Toolkit window in particular are called “**components**.” This refers to each type of processor that operates the DME. “Object” normally refers to Picture, Text, Ellipse and other items that are used after connecting them by wire to the various components.

Component Editor

The blocks that are arranged in the configuration window are called “**components.**” When you double-click on a component block arranged in the Configuration window, the Component Editor window will open. There you can edit the parameters for that component. The types of parameters displayed will differ, depending on the component.

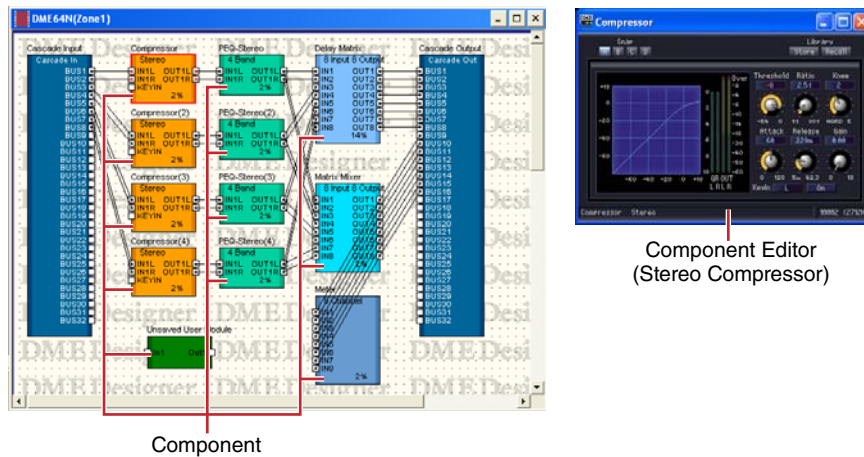

Window Operations

Operations in all windows are the same as for normal Windows applications. The windows are controlled with the [Minimize], [Maximize/Restore], and [Close] buttons at the upper right of the title bar. DME Designer is closed by clicking the [Close] button on the Main Panel window.

Users and Security

You can create multiple users in DME Designer and set the functions that are available to each user. Although users who will design and put together installations must be able to use all the functions of DME Designer, users who will only operate the system can be restricted to functions that will not allow them to accidentally change the settings.

DME Designer is used with one user at a time logged on. To change the user, click the [File] menu → [Log Off] command on the Main Panel window.

About Users

To use DME Designer, you must logon when you start the software. Except for the first time the software is started or when separate settings are made for the first time, you can logon by specifying the name and password for a user that has been set as the administrator. The administrator can build the system as a whole, or apply function limitations that let other people edit. Administrators or other people that can use DME Designer are called “**users**.” The user name for the currently logged on user appears below [User] on the Main Panel window.

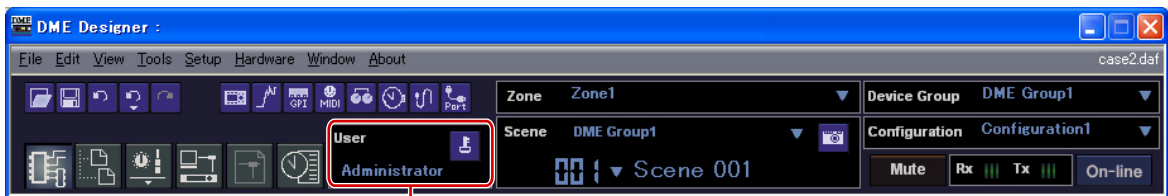

Currently Logged On User Name

The default user, named [Administrator], is set to use all of the functions. Immediately after DME Designer is installed, [Administrator] is the only user, and there is no password set. Multiple users can be created. When the system administrator creates multiple users, restrictions can be applied separately for each one of them. A user with restrictions applied can edit using only the functions the administrator enables for him.

The place to create, setup, and delete users is the “Security” dialog box. See “Scene Manager” on [page 157](#).

Automatic Logging On

With the auto-logon function, you can have a specified user automatically logged on when the application is started. If you enable the auto-logon feature, the specified user will be logged on when the application is started, without displaying the “Log On” dialog box.

Auto-logon is set from the “Security” dialog box. See “Scene Manager” on [page 157](#).

Logging On

The “Log On” dialog box is displayed whenever the application is started or a user is logged off. Whenever one user is already logged on, another user cannot be logged on. To log on as another user, first log off the currently logged on user.

NOTE

Unless you specifically want to restrict access, we recommend enabling automatic logon. If the access password is forgotten or lost it will not be possible to logon or operate the system.

NOTE

If the automatic logon feature is enabled, the “Log On” dialog box will not be displayed when the application is started. Instead, the auto-logon user will be logged on automatically.

■ The “Log On” dialog box

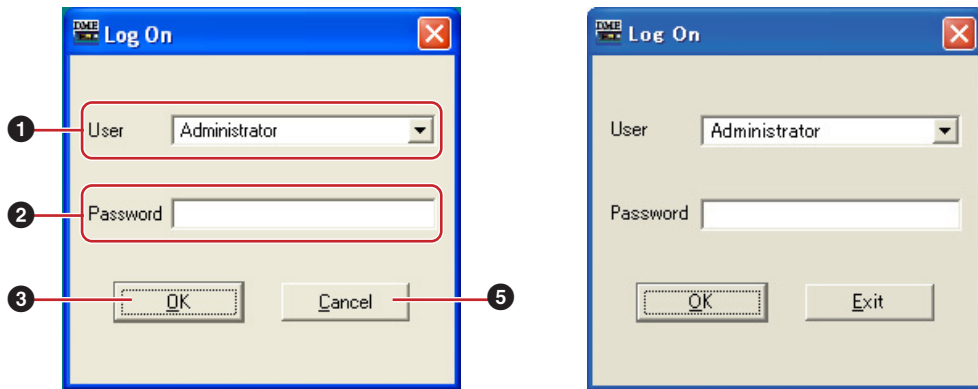

1 [User]

From the list, select the user you want to log on as.

2 [Password] Box

Enter the password.

3 [OK] Button

Log on as the selected user.

4 [Exit] Button

When the application is started, and the “Log On” dialog box is displayed, there is an [Exit] button. This closes the application without logging on a user.

5 [Cancel] Button

When the “Log On” dialog box is displayed after a user is logged off, there is a [Cancel] button instead of an [Exit] button. This cancels the logoff. The original user will continue to be logged on.

■ Logon Procedure

1 Click [▼] at the right of the [User].

A drop-down list of user names will be displayed.

2 Click the user you want to log on.

3 Enter the password into the [Password] box.

When you type in the password box, the characters you enter will display as asterisks (*).

4 Click the [OK] button.

Logging Off

Logoff is used when changing users. When you log off, the document currently being edited is closed, and the “Log On” dialog box is displayed so you can log on the next user. Log off with the [Log Off] command on the [File] menu in the Main Panel window.

- 1 Click the [File] menu → [Log Off] command on the Main Panel window.

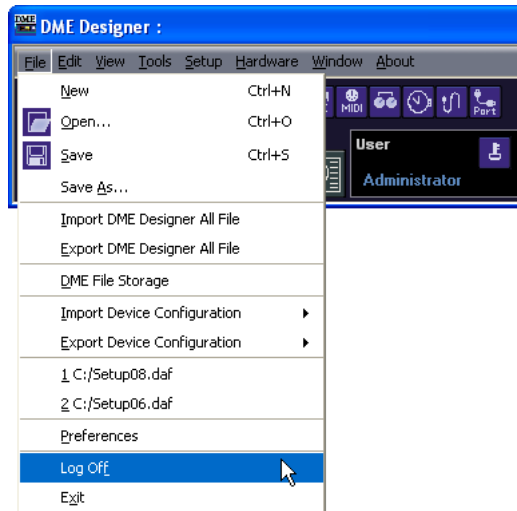

Log on the next user in the “Log On” dialog box.

Files Used by the DME DESIGNER

The following files are used by the DME designer application.

Name	Description	Extension
Project File	Stores information relating to the entire project.	.daf
DME Data File	Stores information for independent DME or SP2060 units.	.ddf
Library File	Stores component parameters.	.cel
	Stores user control parameters.	.ucl
	Stores user module parameters.	.uml
	Stores user modules.	.umf
	Stores SP2060 libraries.	.llf
Wave List File	Stores the Wav File Manager list.	.dwl
DME Backup File	Stores DME or SP2060 backup data to a file.	.dbk
SP2060 Backup File	Stores SP2060 unit data as SP2060 Backup file.	.spb
DME Designer All File	Stores the project file, library data files, and all DME Designer settings at once.	.dme

Project Files

Systems built with DME Designer are saved as project files. Project files have “.daf” as the extension for their filenames.

These files include settings for the area, zones, device groups, configurations, and each parameter.



Since only one project file can be open at a time, before you can open a second file, the first one must be closed.

The commands for opening project files, creating new ones, and saving them, are found in the [File] menu of the Main Panel window.

Creating New Project Files

Project files are created using the [File] menu → [New] command in the Main Panel window.

- 1 Click [File] menu → [New] in the Main Panel window.
 Since the currently open project file must be closed before a new one can be created, a “Project file has been modified. Save?” dialog box will be displayed.

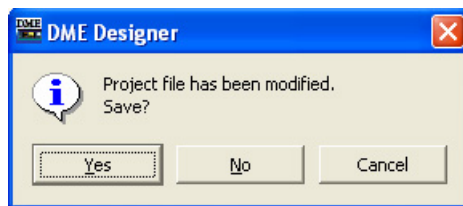

- 2 To save the file, click [Yes]. the File Save dialog box will be displayed.
 If you click [Yes], the File Save dialog box will be displayed.
 A new project file will be created.

Saving Project Files

Project files are saved using the [File] menu → [Save] and [Save As] commands in the Main Panel window. The [Save] command overwrites the previously saved version of the file. The [Save As] command lets you give a new name to the file before saving it. When you save the file with a new name, you can protect it with a password.

■ The “Save As” Dialog Box

When you click the [File] menu → [Save As] command in the Main Panel window, the “Save As” dialog box is displayed. Except for some [Security] options, this dialog box is the same as the normal Windows dialog box for saving files.

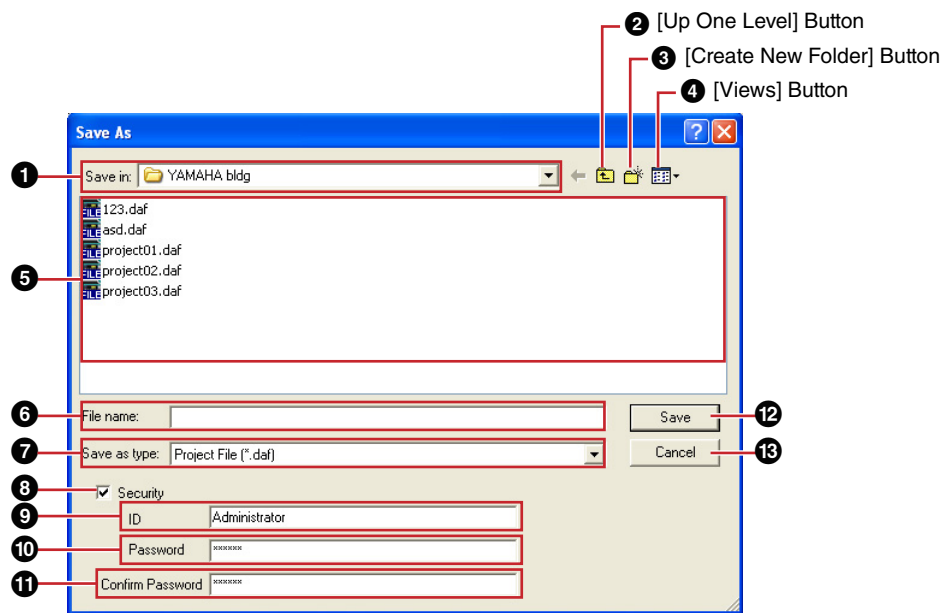

1 [Save In]

Specify the folder for saving the file. The folder name is displayed in this box. Click the [▼] on the right to move to another folder.

The large box below displays the contents of the folder in this box.

2 [Up One Level] Button

Moves to the folder one level higher in the hierarchy.

3 [Create New Folder] Button

Creates a new folder in the folder currently being displayed.

4 [Views] Button

Changes the way the folder content list is displayed. If you click this button, a menu appears that lets you change the arrangement and display format of the files in the list.

5 List

This box displays the contents of the folder shown in the [Save In] box. Only files belonging to the type selected in the [Save As Type] box will be displayed.

6 [File Name] Box

Enter the filename. If the currently open file has already been saved, its name will be already entered in this box. To save using a different filename, change the name here.

7 [Save as type]

Selects the format for the file you are saving. When saving project files including Wave files set for Wav File Player, select “Project File with wave (*.daf)”. Otherwise, select “Project File (*.daf)”.

8 [Security]

Protects files with a password. If you check here, you will be able to enter settings in the [ID], [Password], and [Confirm Password] boxes.

9 [ID] Box

Enter the ID that has been set for the file. The currently logged on user name will be pre-entered, but you can change it. This need not be the same as a user name.

10 [Password] Box

Enter the password that has been set for the file. You can enter up to 256 alphanumeric characters. The characters you enter will be displayed as asterisks (*) in the [Password] box.

11 [Confirm Password] Box

Enter the password once again to confirm it. Enter the same password as was entered into the [Password] box. The characters you enter will be displayed as asterisks (*), the same as in the [Password] box.

NOTE

When someone attempts to open a password-protected project file, the application will request an ID and password. If they are not entered correctly, the file cannot be opened. Be careful to avoid mistakes when entering the ID and password. The password cannot be reissued and the ID and password cannot be changed. Be careful not to forget them.

12 [Save] Button

Saves the project file.

If the characters entered into the [Password] and [Confirm Password] boxes were not the same, a “Password is different” dialog box will be displayed. Click the [OK] button and reenter the correct password in the [Password] and [Confirm Password] boxes.

**13 [Cancel] Button**

Cancel the file save process.

■ Saving Project Files

- 1 Click [File] menu → [Save] in the Main Panel window.

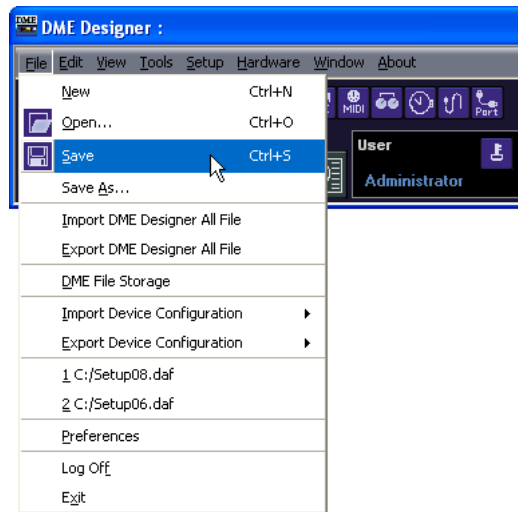

If there is a file already saved with the same name, it will be overwritten.

When saving a project file for the first time, you must name the file before saving it. The “Save As” dialog box will open, the same as when clicking the [File] menu [Save As] command. Enter a filename and specify the folder where the file will be saved.

■ Saving a File with a New Name

With the [File] menu [Save As] command in the Main Panel window, you can save the currently open file with a new filename. When saving for the first time, this creates a new file. A file that has already been saved with a name will be saved as a separate file.

- 1 Click [File] menu → [Save As] in the Main Panel window.
The “Save As” dialog box will be displayed.

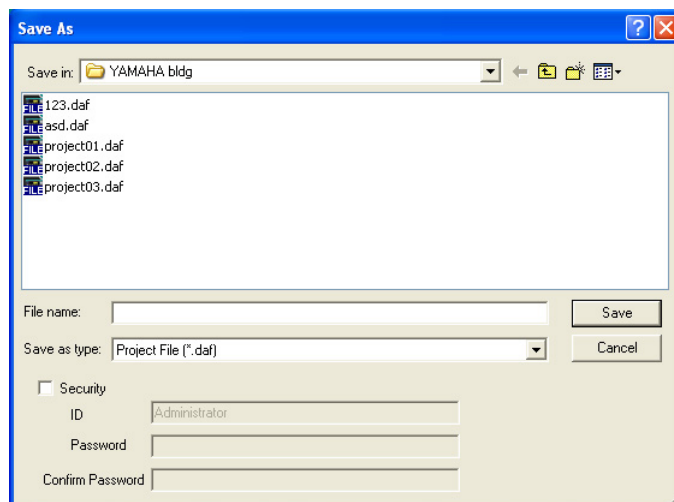

- 2 Enter a filename into the [File name] box.
- 3 Specify the folder where the file will be saved.
- 4 Click the [Save] button.

■ Protecting a Project File with a Password

When you save a project file with a new name, you can set a password and protect the file. If a password is set, an ID and password will be requested when the file is opened.

The security settings for a file cannot be changed by resaving the file with the same name. They can only be changed when saving the file with a new name using the [Save As] command. Once set, the ID and password cannot be changed. To change the ID and password for password-protected project files, use the [Save As] command to save the file as a new one with a different name.

1 Click [File] menu → [Save As] in the Main Panel window.

The “Save As” dialog box will be displayed.

2 Place a checkmark for [Security] in the file save dialog box.

3 Enter an ID into the [ID] box.

The name of the currently logged on user will be automatically entered into the [ID] box. To change it, enter another ID into the box.

When using [Save As] to save a password-protected file, the dialog box will be displayed with the ID and password boxes automatically filled in with the ID and password that were assigned to the original file. To change the ID and password, enter new ones into the boxes.

4 Enter the desired password into the [Password] box.

You can enter up to 256 alphanumeric characters for the password. The characters you enter will be displayed as asterisks (*) in the [Password] box.

5 Enter the same characters into the [Confirm Password] box as were entered into the [Password] box.

The characters you enter will be displayed as asterisks (*) in the [Password] box.

6 Click the [Save] button.

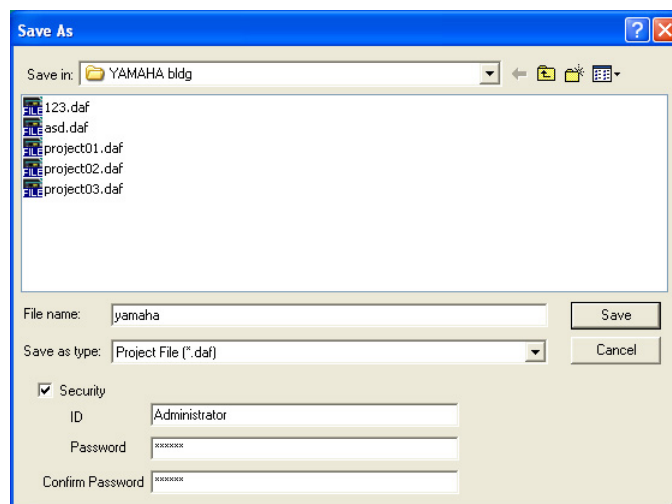

When saving a password-protected file without changing the name, the same ID and password will be set (the ID and password cannot be changed).

Using the [Save] command, you cannot password protect an already saved project file that was not already password protected. To set a password for a file that is not already password protected, save it as a separate file using the [Save As] command.

Opening Project Files

Project files are opened using the [File] menu → [Open] command in the Main Panel window. Since the currently opened project file must be closed before another one can be opened, a “Project file has been modified. Save?” dialog box may be displayed.

■ [Open] Command

Project files are opened using the [File] menu → [Open] command in the Main Panel window.

1 Click [File] menu → [Open] in the Main Panel window.

A “Project file has been modified. Save?” dialog box may be displayed.

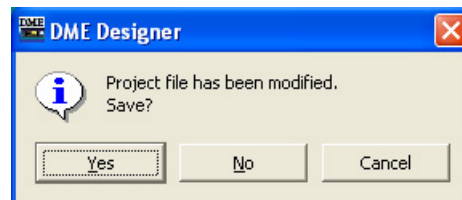

2 Click the [Yes] or [No] button.

The “Open” dialog box will be displayed.

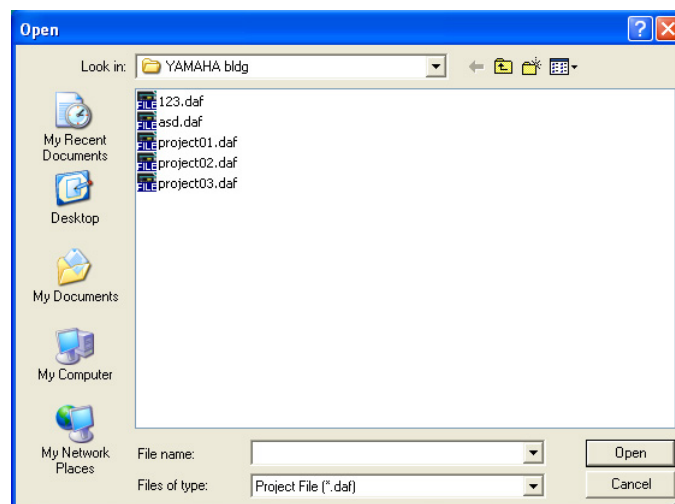

3 Selects the file to be opened.

4 Click the [Open] button.

■ Opening a Project File That Has Security Set

If security is set for a project, the “Enter ID & Password” dialog box will be displayed when you click the [Open] button in the “Open” dialog box.

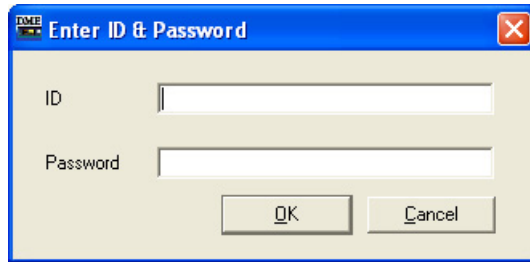

Enter the ID and password for the file into the [ID] and [Password] boxes, and click the [OK] button.

If you enter an incorrect ID or password and click the [OK] button on the “Enter ID & Password” dialog box, the “Wrong ID or password!” dialog box will be displayed.



Click the [OK] button and enter the correct ID and password the “Enter ID & Password” dialog box.

■ Opening a Project File from the “Recently Used Files” List

Recently used project files are displayed on the [File] menu in the Main Panel window. If you click one of the filenames, you can open that project file.

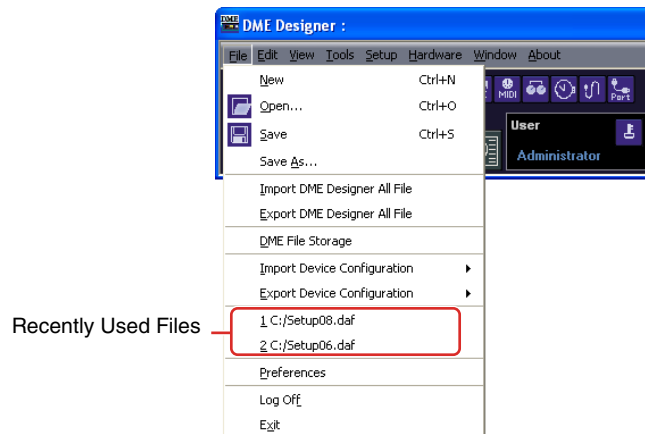

If security is set for a project file, the “Enter ID & Password” dialog box will be displayed if that file is selected from the recently used files list. Enter the ID and password to open the file.

■ Double-Click the Icon for the Project File

When you double-click the icon for the project file, the file will open. If DME Designer is not started, it will start. After logon, the project file will open.

Just as when you use the [Open] command, if DME Designer is already started, the currently open project file must be closed before another one can be opened. Therefore, a “Project file has been modified. Save?” dialog box will be displayed.

NOTE

Sometimes the “Project file has been modified. Save?” dialog box will not be displayed.

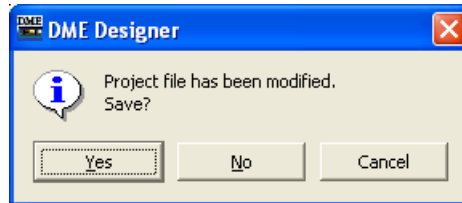

If security is set for the project file, the “Enter ID & Password” dialog box will be displayed. Enter the ID and password to open the file.

Closing Project Files

You cannot have multiple project files open simultaneously in DME Designer. To close the currently open project file, you can create a new project file or open another project file.

DME Data File

You can import or export parameters for a DME or SP2060 that is arranged in a configuration file. Parameters for a single DME or SP2060 unit in the current configuration (the one being edited) are saved as a file. Saved parameters can be imported into another project file. Files with parameters saved in them are called “**DME Data Files.**” These files have “.ddf” as the extension for their filenames.



data01.ddf

DME Data Import

This imports DME data file settings into a DME or SP2060 included in the current configuration.

- 1 Activates the DME or SP2060 configuration layout to be imported.
If multiple configurations are available, the DME or SP2060 configuration layout to be imported can be selected via the Navigator window.
- 2 Click the [File] menu in the Main Panel window, and move the mouse cursor over [Import Device Configuration].
A submenu will be displayed. The DME groups and SP groups included in the current configuration will be displayed on a submenu.

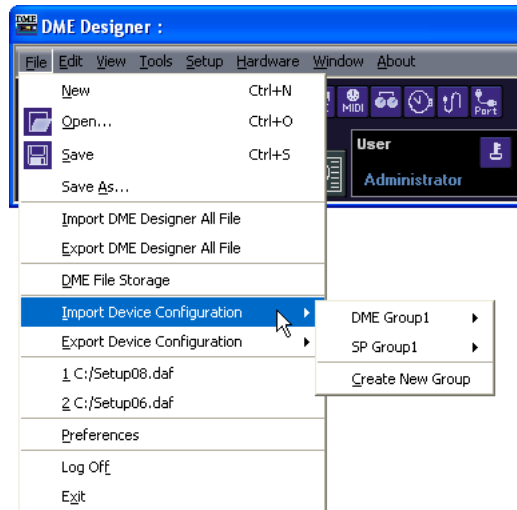

- 3 Select the device group to which the DME or SP2060 is to be imported from the submenu.
DME and SP2060 units cannot be used assigned to the same device group.

NOTE

DME and SP2060 units cannot be combined in the same Device Group.

- 4 On the submenu, click on the DME or SP2060 into which you will import settings.
The "Open" dialog box will be displayed.

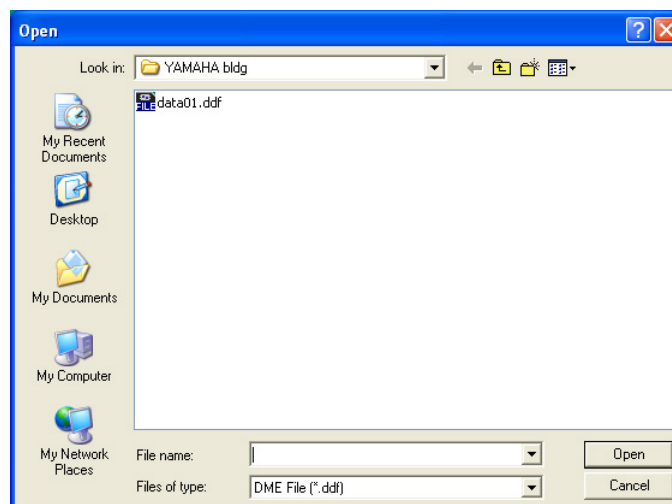

- 5 Select the DME data file and click the [Open] button.

■ [Import Device Configuration] Submenu

The device groups included in the current configuration, as well as the DME or SP2060 units included they contain, will be displayed in the [Import Device Configuration] submenu.

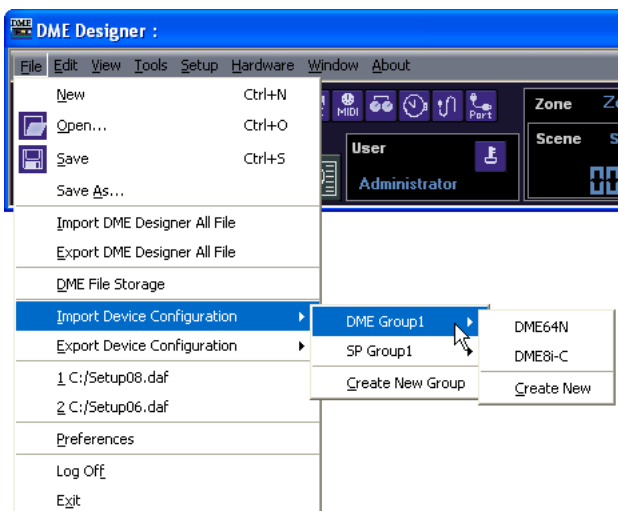

Select [Create New Group] to create a new device group
[Create New DME] creates a new DME and imports settings.

NOTE

Only users for whom the [Operation Security] → [Edit] checkbox in the "Security" dialog box has been checked can import DME data. For information about user security levels, see "Scene Manager" on [page 157](#).

NOTE

If DME data file import was not possible, a "DME file import failed." message will be displayed.

DME Data Export

This exports parameters from a DME or SP2060 included in the current configuration and saves them as a file.

- 1 Activates the DME or SP2060 configuration layout to be exported.
If multiple configurations are available, the DME or SP2060 configuration layout to be exported can be selected via the Navigator window.
- 2 Click the [File] menu in the Main Panel window, and move the mouse cursor over [Export Device Configuration].
A submenu will be displayed. The DME groups and SP groups included in the current configuration will be displayed on a submenu.

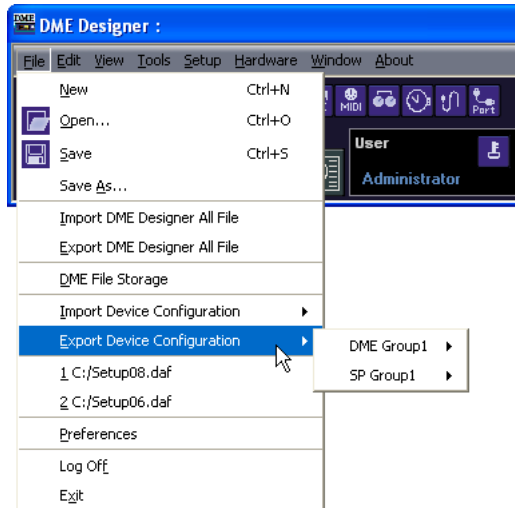

- 3 On the submenu, click on the DME or SP2060 from which you will export settings.
The "Save As" dialog box will be displayed.

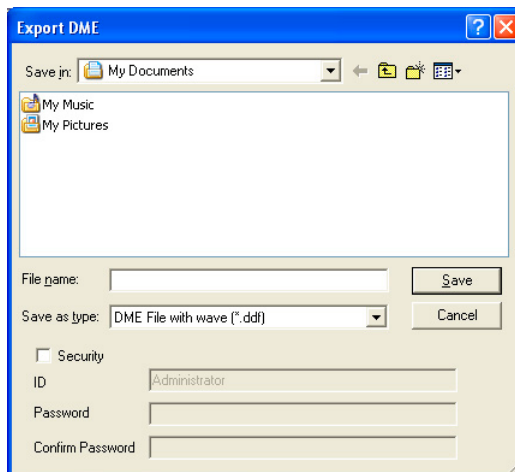

- 4 Enter the filename.
Determines whether a selected file type will be exported along with a wave file.
- 5 Specify the folder where the file will be saved, then click the [Save] button.

NOTE

Library data is not contained in the DME data files exported from SP2060.
Refer to "SP2060 Library Manager" on [page 153](#).

■ [Export Device Configuration] Submenu

The DMEs or SP2060s included in the current configuration will be displayed on the [Export Device Configuration] submenu.

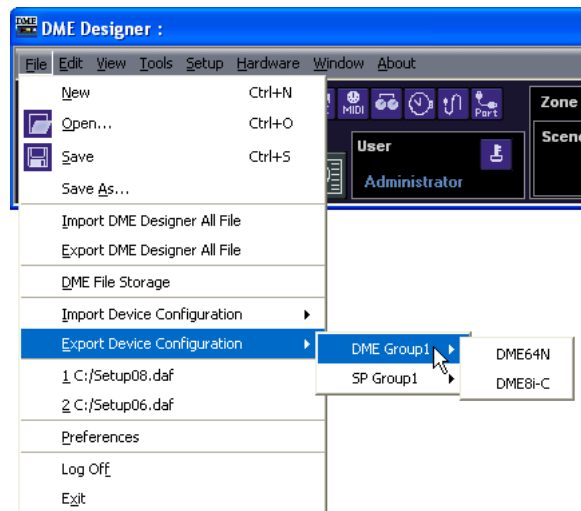

Library Files

Component Editor, User Control Editor, and User Module Editor parameters can be stored to and recalled from library files. Refer to “Library Files” on [page 325](#).

The library data for a single SP2060 unit can be imported or exported as required. Refer to “SP2060 Library Manager” on [page 153](#).

DME Designer All Files

The project file and all DME Designer settings related to the project file can be managed as a DME Designer All file. DME Designer All files have a “.dme” extension.

DME Designer All files include the settings listed below:

- Project file
- Library files
- User module files
- Wave files
- Picture files
- All DME Designer settings

DME Designer All files are a convenient way to move project data and DME settings you have created from one computer to another. The DME Designer All import and export commands are provided in the Main Panel Window [File] menu.

Importing DME Designer All Files

NOTE

Only users with Administrator access can import DME Designer All files.

- 1 Click [Import DME Designer All File] in the Main Panel Window [File] menu.
Since the imported data will overwrite the existing DME Designer settings, the confirmation message shown below will appear.

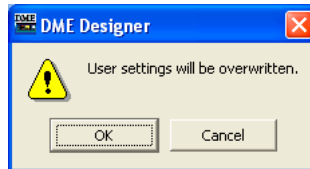

- 2 Click [OK] to continue with the import procedure, or [Cancel] to abort the import.
If you click [OK] the "Open" dialog box will appear.

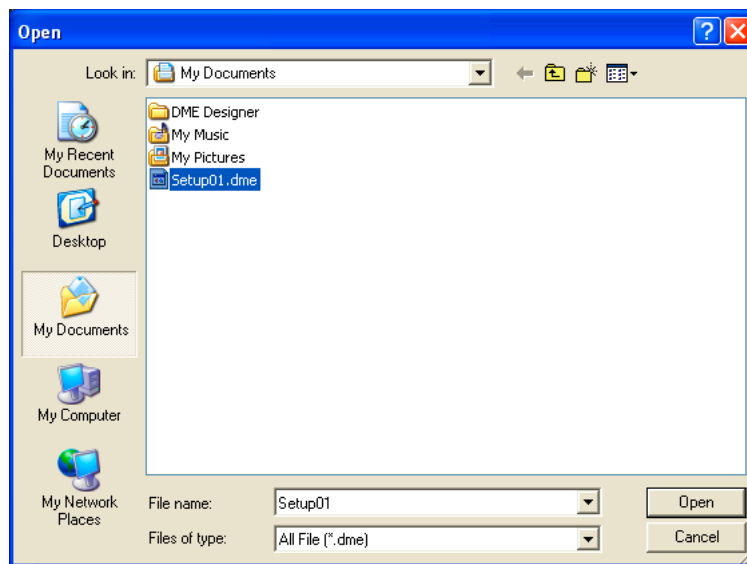

- 3 Select the DME Designer All file you want to import.
- 4 Click the [Open] button.

- 5** The “Save Project File in DME Designer All File” dialog box will appear, allowing you to save the imported project file.

For details on saving project files refer to “Saving Project Files” on [page 35](#).

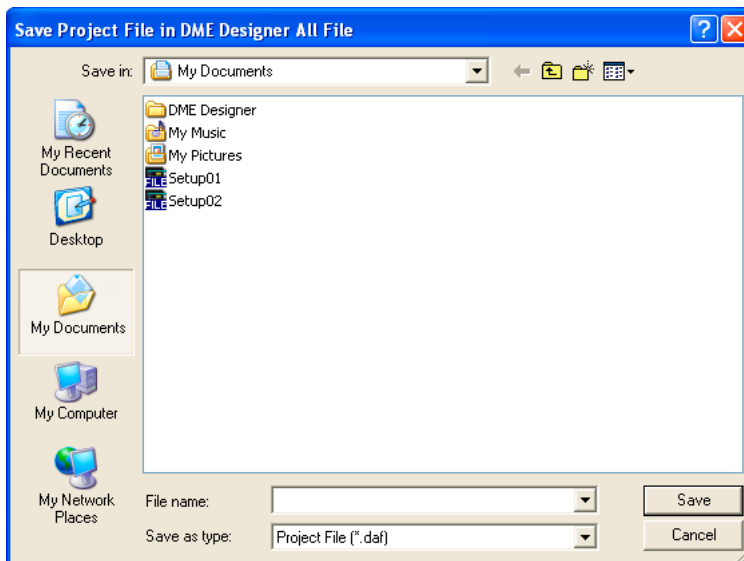

- 6** If security is set for the file the “Enter ID & Password” dialog box will appear. Enter your ID and password, and click [OK].

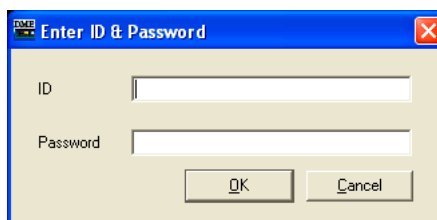

The imported files are stored in the folders listed below.

Name	Folder
Project File	Specified in step 5.
Library Files	The “Library” folder in the folder specified by the [Contents Folder] item in the Main Panel Window “Preferences” window.
Wave Files	The “Wav” folder in the folder specified by [Contents Folder].
Picture Files	The “image” folder in the folder specified by [Contents Folder].

Exporting DME Designer All Files

1 Click [Export DME Designer All File] in the Main Panel Window [File] menu.

The “Select File for Export” dialog box will appear. Check the checkboxes of the files you want to export. To select all the available files click the [Select All] button, or click [Clear All] to uncheck all the files.

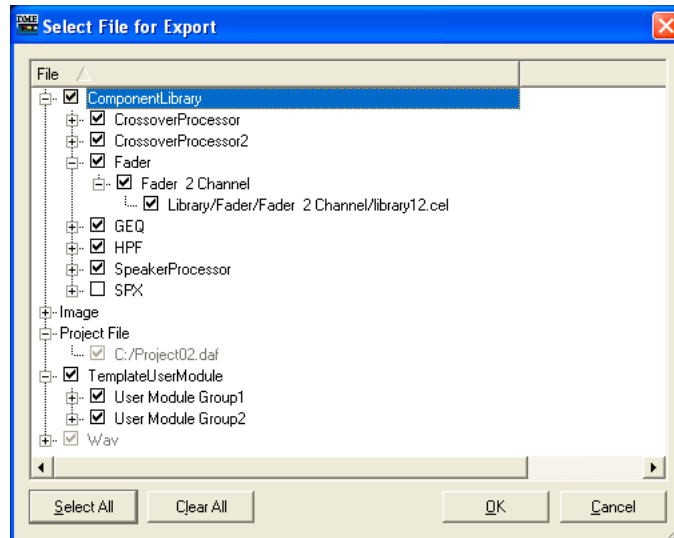

NOTE

- Only wave and image files used by the currently open project file will be displayed. All user module templates will be displayed under TemplateUserModule.
- The project file and image files will always be exported, so their checkboxes cannot be removed. The DME Designer settings will also always be exported, so they are not displayed here.

2 Check the file(s) to be exported and click [OK].

The “Save As” dialog box will appear. This is the same as the “Save As” dialog box used when saving project files, and details can be found in the “Saving Project Files” section on [page 35](#).

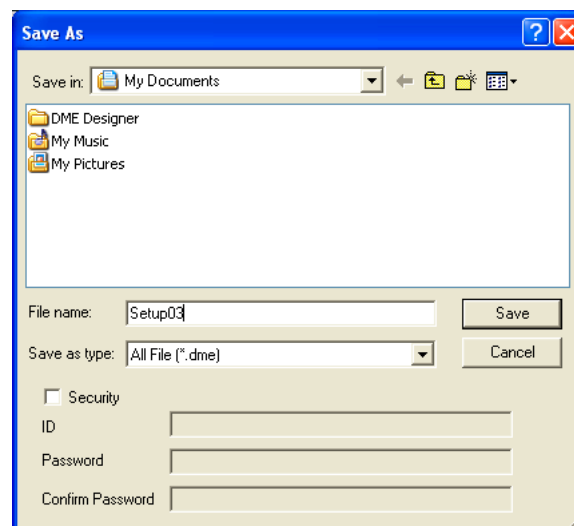

3 Enter a file name, destination folder and, if necessary, security settings including ID and password, then click the [Save] button.

Configuration Creation Procedure

The configuration is a design diagram that determines the DME configuration. Transferring this data causes the DME to operate. Follow the procedure below to create a DME Designer configuration. SP2060 configurations can be selected from scene preset data, but cannot be edited.

NOTE

Configurations can be created only when the DME unit is offline. To transfer the data, you must first go into online status. The procedure for going online is given later in this document.

1 Creating a New Project.

When you start DME Designer, a new project is created. If another project file is already open, use the [File] menu → [New] command in the Main Panel window to create a new file.

“Main Panel Window Menu” → [File] menu → [New] ([page 60](#))

2 Zone Settings.

Zone names are set, and zones are added and deleted using the “Zone Manager” dialog box.

See “Adding, Deleting, and Renaming a Zone” on [page 291](#).

3 DME, ICP, External Device Layout.

Position the required DME, ICP, and other external devices in the Designer window, set the device groups for the DME and ICP units, and set the properties.

See “Device Group Selection” on [page 276](#),

“Designer Window” on [page 193](#),

“Objects” on [page 210](#),

“Design Window Shared Settings and Operations” on [page 268](#).

4 Configuration Settings.

Configurations can be named, added, and deleted via the “Configuration” dialog box.

See “Adding, Deleting, and Renaming a Configuration” on [page 295](#).

5 Placing Components.

Place components and user modules in the Configuration window.

See “Configuration Window” on [page 301](#),

“User Module” on [page 309](#),

“Types of Components” on [page 371](#).

6 Component Logical Connections.

Use wires to connect the components and user modules you placed in the Configuration window.

See “Drawing and Editing Wires” on [page 279](#).

7 Setting Parameters.

Edit the component parameters in the component editor.

See “Component Editor Window” on [page 319](#).

8 Setting User Defined Button

Parameters can be assigned to function keys F1 through F6 in the DME unit.

See “User Defined Button (User Defined Parameters)” on [page 132](#).

9 Storing Scenes.

Store the scene using the [Tools] menu → [Scene Manager] command in the Main Panel window.

See “IP Address Setup” on [page 82](#).

Online

You can connect the DME or SP2060 unit to your computer and transfer configurations, scenes and parameters created in DME Designer into the DME or SP2060 unit. You can also read data from the DME or SP2060 unit into DME Designer, synchronizing it with the status of the DME or SP2060 unit. Because Synchronization presupposes that the DME or SP2060 unit can communicate with the computer where DME Designer is installed, the necessary drivers (USB-MIDI or DME-N Network Driver) must be installed, and appropriate settings must be made for each driver and for DME Designer communication port.

NOTE

Because there are no scene settings when the DME unit is purchased, the configuration and scene information created in DME Designer must first be transferred.

NOTE

A maximum of 32 device groups can be online.

1 DME Unit and Computer Connection.

Connect the DME unit and computer using a USB cable or an Ethernet cable.
See separate DME or SP2060 unit Owner's Manual for details.

2 Communication Driver Installation.

Install the USB-MIDI driver or DME-N Network driver in the computer.
See separate "DME Setup Manual" for details.

3 Communication Driver Setup.

Make the necessary settings for the communication driver installed in the computer. If the driver is set up already, check the settings before going online.
See separate "DME Setup Manual" for details.

4 Making Communication Port Settings in DME Designer.

The port for each device group master can be selected via the "Communication Port" dialog box. If the driver is set up already, check the settings before going online.
"Communication Port" dialog box ([page 155](#))

NOTE

Slave DME64N/DME24N units connected via Ethernet and ICP1 units cannot be set.

NOTE

Only USB x-1 can be selected for a DME Satellite unit connected via USB.

5 Storing and Checking Scenes.

When moving online, the lowest scene must be stored. You can check if a scene is stored using the "Scene Manager" dialog box.

NOTE

Since the SP2060 has scene preset data this confirmation is not necessary.

See "Scene Manager" on [page 82](#).

6 Recalling Scenes.

When going online, the scene will be recalled. Its scene number must be displayed in [Scene Number], and its scene name will be displayed in Scene Name. If [-----] is displayed of [Scene Name], the scene will be recalled.

NOTE

Since the SP2060 has scene preset data this confirmation is not necessary.

NOTE

When the scene device group display mode is "ALL" the scene link name will be displayed. Select a DME group to display the DME group scene name.

Main Panel Window → "Current Scene" (page 57)

See "Scene Manager" on page 82.

7 Display the "Synchronization" dialog box.

Click [Synchronization] in the [Tools] menu or the large [Synchronization] button on the toolbar. When the dialog box opens, a list of connected DME and SP2060 units will be obtained. DMEs and SP2060s connected to the computer are displayed in the [Network] list.

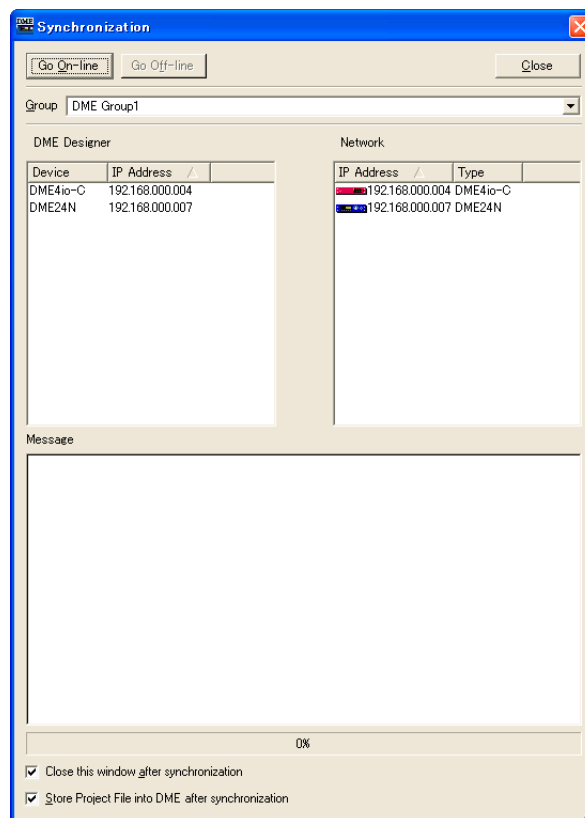

NOTE

When requesting the "Synchronization" dialog box, a one-time alert will be displayed if the Communication Port settings have not been made. After clicking the [OK] button on the alert, a dialog will open. At this time, you can make the needed settings in the displayed dialog box, and then again display the "Synchronization" dialog box.

8 Device Group Selection

Select the device group to be synchronized from the [Group] list in the [Synchronization] window.

NOTE

Only one device group can be online in one operation.

9 IP Address Selection

The DMEs and SP2060s included in the current device group are displayed in the [Designer] list in the “Synchronization” dialog box. Click the [IP Address] box, then select the DME or SP2060 unit IP address that matches the DME or SP2060 currently in the DME Designer.

NOTE

Click [▼] to display the IP addresses of all similar devices in the area.

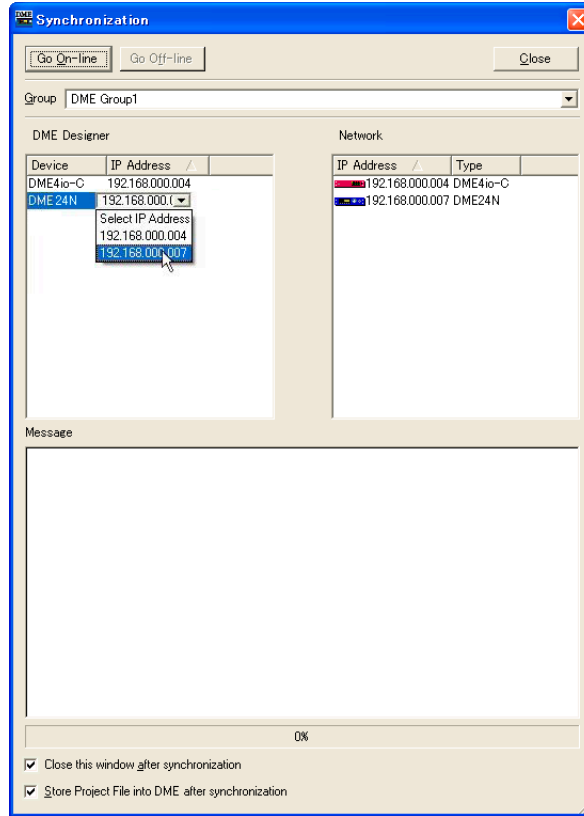

10 Going Online.

Clicking the [Go On-line] button displays a dialog box where you can decide the synchronization method.

NOTE

An alert will be displayed if no scene has been recalled.

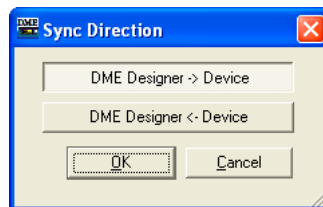

Click the [DME Designer → Device] direction button. Transfer of the configuration will begin, and DME Designer will be synchronized with the unit. If there are many zones, this process may take time.

NOTE

When a configuration has already been transferred to a DME unit, we recommend using the [DME Designer <- Device] button for synchronization. The transfer time is faster than using the [DME Designer -> Device] button. If the configuration has been edited, however, synchronization can only be achieved by using the [DME Designer -> Device] button.

When going online is finished, the [Go On-line] button will be grayed out, and the Main Panel window [On-line] button will light up. At this point if the [Store Project File into DME after synchronization] item is checked, the project file will be automatically transferred to the DME unit and stored. And if the [Close this window after synchronization] item is checked, the window will close automatically.

NOTE

It may not be possible to go online if a scene has not been stored when [Recall Safe] is selected.

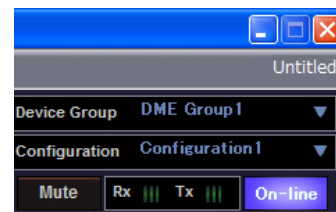
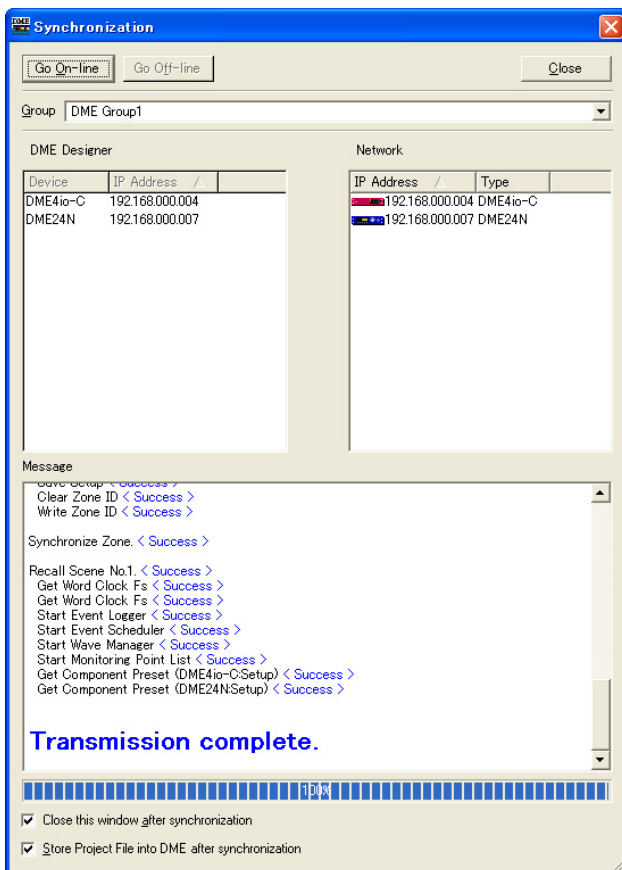

To go off line, click either the [On-line] button in the main panel window, or the [Go Off-line] button in the "Synchronization" dialog box.

NOTE

If the IP address of the DME device is changed after the device has been synchronized with DME Designer, it will be necessary to re-transfer the configuration data. The "Full Resync" operation forces a re-transfer of all configuration data, and can be initiated by clicking the [Go On-line] button while holding down the [Ctrl] key.

NOTE

If LAN cable connections are changed while DME Designer is running, the DME units will continue to attempt to connect to the original computer. If it is necessary to switch computers, either quit DME designer before changing the connections or set the Port parameter to No Assign.

Chapter 3 Main Panel Window

Names and Functions of the Windows

The Main Panel window is the main window of DME Designer.

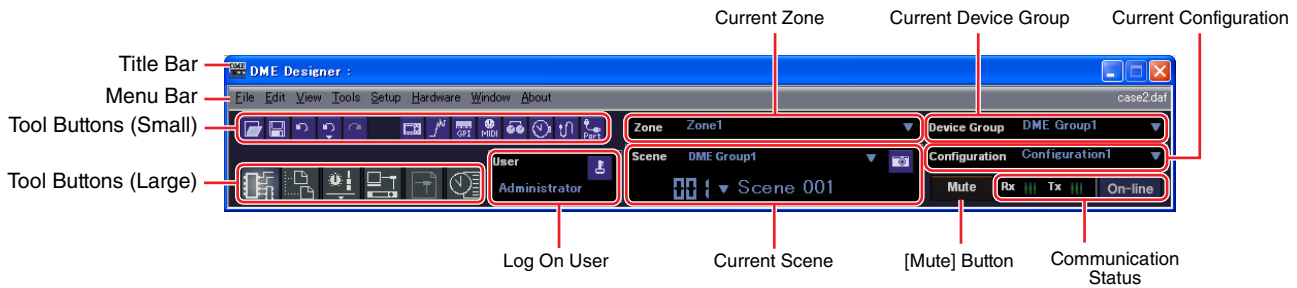

Title Bar

"DME Designer" is displayed on the title bar.

Menu Bar

Commands that can be executed in the application are collected into categories on the menu bar. When you click one of the categories, a list of commands is displayed.

Also, the name of the currently open project file is displayed at the right. When a new project file has been opened, or has not yet been saved, "Untitled" will be displayed for the file name.

Tool Buttons (Small)

Frequently used commands are arranged here as buttons. When a command cannot be used, its button will be grayed out.

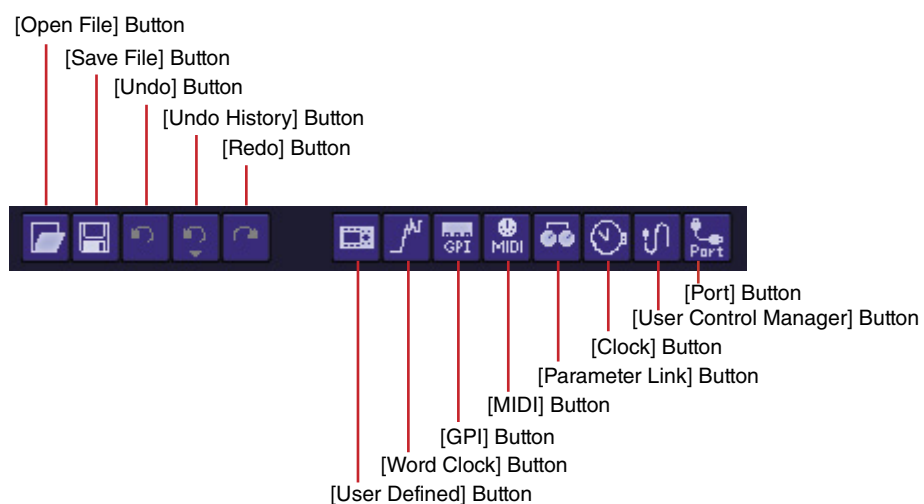

■ [Open File] Button

Opens project files.

→ [Open] on the [File] menu ([page 61](#))

■ [Save File] Button

Saves the project file currently being edited.
→ [Save] on the [File] menu ([page 61](#))

■ [Undo] Button

Undoes the most recent edit operation.
→ [Undo] on the [Edit] menu ([page 63](#))

■ [Undo History] Button

Opens the “Undo History” dialog box. Undoes multiple operations.
→ [Undo History] on the [Edit] menu ([page 63](#))

■ [Redo] Button

Restores operations undone with the [Undo] button back to their original condition.
→ [Redo] on the [Edit] menu ([page 63](#))

■ [User Defined] Button

Opens the “User Defined Button” dialog box.
→ See “[User Defined Button]” on [page 132](#).

■ [Word Clock] Button

Opens the “Word Clock” dialog box.
→ See “[Word Clock]” on [page 177](#).

■ [GPI] Button

Opens the “GPI” dialog box.
→ See “[GPI]” on [page 112](#).

■ [MIDI] Button

Opens the “MIDI” dialog box.
→ See “[MIDI]” on [page 125](#).

■ [Parameter Link] Button

Opens the “Parameter Link” dialog box.
→ See “[Parameter Link]” on [page 94](#).

■ [Clock] Button

Opens the “Clock” dialog box.
→ See “[Clock]” on [page 180](#).

■ [User Control Manager] Button

Opens the “User Control Manager” dialog box.
→ See “[User Control]” on [page 325](#).

■ [Communication Port] Button

Opens the “Communication Port” dialog box.
→ See “Communication Port” dialog box on [page 155](#).

Tool Button (Large)

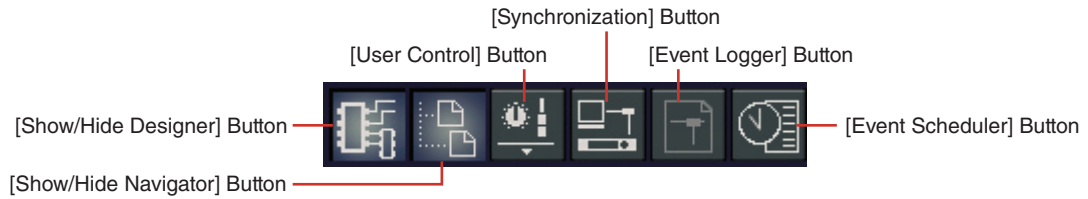

■ [Show/Hide Designer] Button

Displays or hides the Designer window.

■ [Show/Hide Navigator] Button

Displays or hides the Navigator window.

■ [User Control] Button

Works the same as the [User Control] command on the [View] menu. Clicking this button displays a menu.

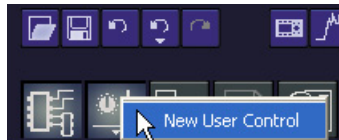

User Control will be display there, the user control window will be displayed. If you click [New User Control], the “New User Control” dialog box opens.

■ [Synchronization] Button

Opens the “Synchronization” dialog box.
→ See “Synchronization” Dialog Box on [page 98](#).

■ [Event Logger] Button

Opens the “Event Logger” window.
→ See “Event Logger” Window on [page 75](#).

■ [Event Scheduler] Button

Opens the “Event Scheduler” dialog box.
→ See “Event Scheduler” Dialog Box on [page 101](#).

Current Zone

Displays the name of the active zone. A list where you can select a zone is displayed when you press the [▼].

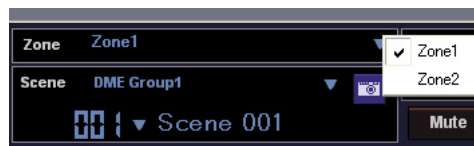

Current Scene

Displays information about the current scene. You can switch between scenes.

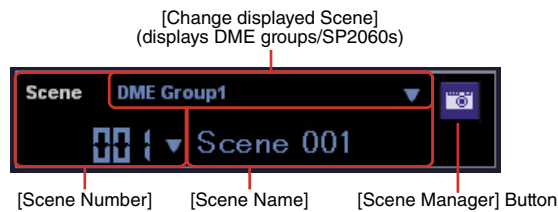

■ [Change Display Scene]

Selects the information to be displayed. When “All” is selected scene link information is displayed in [Scene Number] and [Scene Name]. When a DME group or SP2060 is selected scene information is displayed in [Scene Number] and [Scene Name].

Refer to “Scene Manager” on [page 82](#) for information on scenes, and “Scene Link Manager” on [page 151](#) for information on scene linking.

■ [Scene Number]

Displays the number of the current scene or scene link. A list where you can select a scene or scene link is displayed when you press the [▼]. The EDIT indicator will light when a parameter has been edited after recalling or storing a scene.

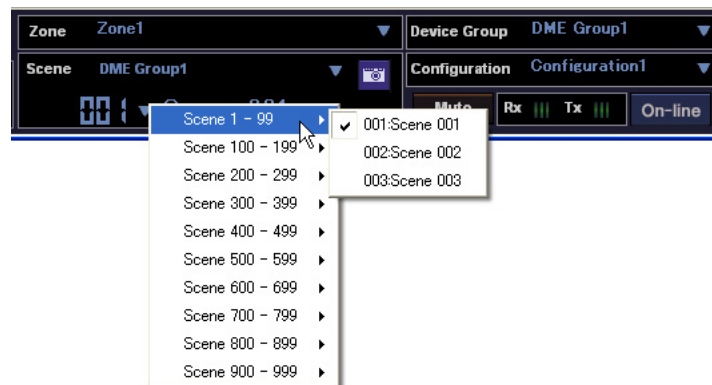

NOTE

Press <Ctrl> key and <+> key simultaneously recall the next scene and press <Ctrl> key and <-> key simultaneously recall the previous scene. These settings can be changed via the Shortcut keys dialog box ([page 156](#)).

■ [Scene Name]

Displays the name of the current scene or scene link.

■ [Scene Manager] Button

Opens the “Scene Manager” dialog box.

[User] (Logged On User)

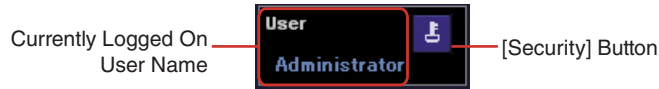

■ Currently Logged On User Name

Displays the currently logged on user name.

■ [Security] Button

Opens the “Security” dialog box.

Current Device Group

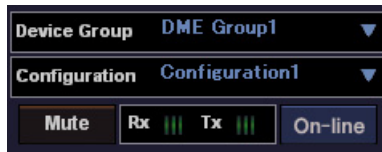

Displays the name of the currently active device group. Click [▼] to display a list that allows selection of a different device group.



Current Configuration

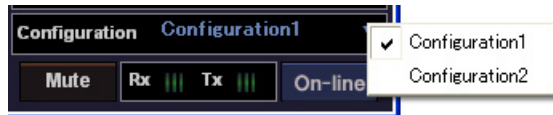

Displays the name of the currently active configuration. Click [▼] to display a list that allows selection of a different configuration.

■ [Mute] Button



Mute OFF

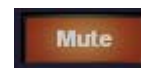

Mute ON

Turns ON and OFF the DME mute button for the current device group.

To turn it ON, press the <Shift> key while clicking. If you click the button while it is OFF without pressing the <Shift> key, the following message will be displayed: “Click the Mute Button with the Shift Key.”

To turn it OFF, click on the button. There is no need to press the <Shift> key.



■ Communication Status

Displays the status of communication between the group master of the current device group and the computer.



[On-line] Button

When the group master of the current device group is connected to a computer, clicking this button alternately switches the unit's on-line/off-line status. The indicator will light when the DME unit is on-line.

Message Transmit/Receive Indicators

- [Rx]
Lights when MIDI messages from the group master of the current device group are received by DME Designer.
- [Tx]
Lights when MIDI messages are transmitted from DME Designer to the group master of the current device group.

Main Panel Window Menu

[File] Menu

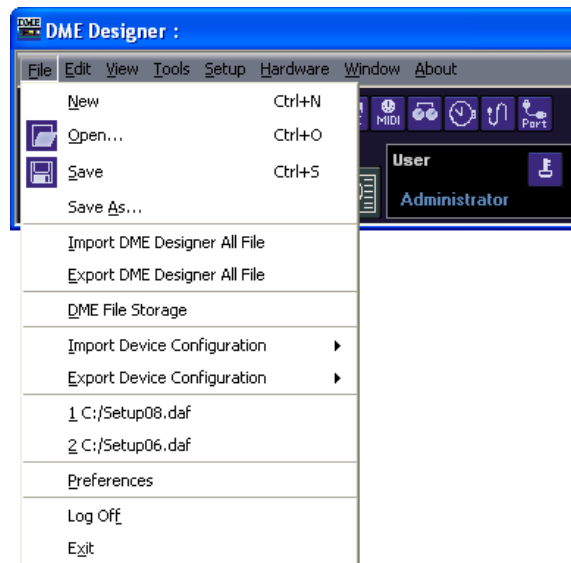

■ [New]

Creates a new project. When a new project is created, the current project will be closed. A confirmation message asking “Project file has been modified. Save?” will be displayed.

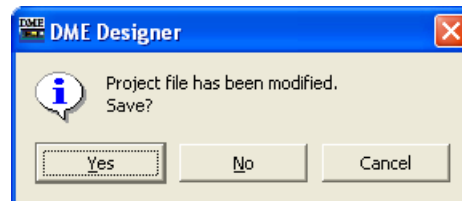

[Yes] Button

Saves the currently open project.

If the currently open file was already given a name and saved, that saved file will be overwritten. The “Save As” dialog box will be displayed for files that have not yet been saved. In this dialog box, you can name the file when you save it.

[No] Button

Closes the project without saving it. If the file has already been given a name and saved, the most recently saved version will remain as is. If the project has not been given a name and saved, it will be lost.

[Cancel] Button

Cancels creation of a new project.

■ [Open]

Opens saved project files. Because the currently open project will be closed, a confirmation message asking “Project file has been modified. Save?” will be displayed.

When you select this command, the “Open” dialog box will be displayed. Select the project file you want to open and click the [Open] button.

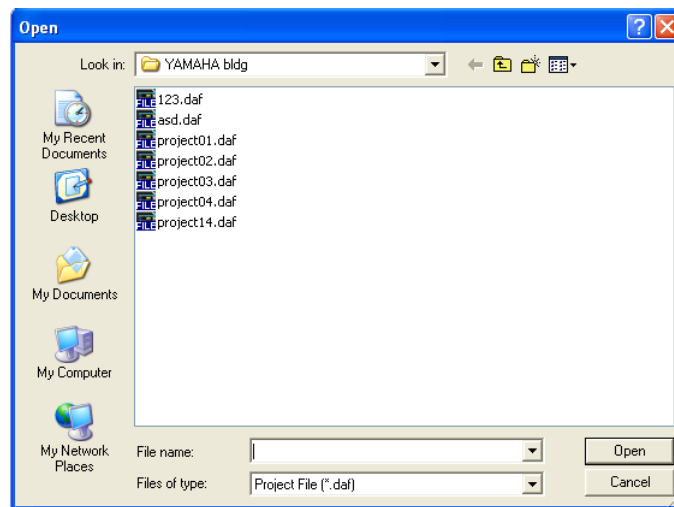

If security is enabled for the project file, the “Enter ID & Password” dialog box will be displayed. Enter the ID and password to open the file and click the [OK] button. The project file will open.

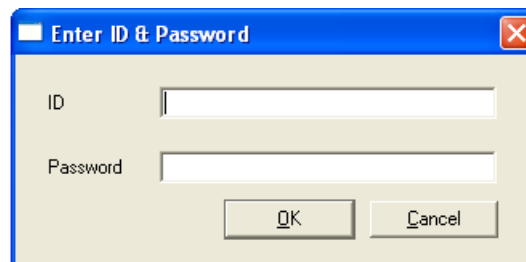

■ [Save]

Overwrites an already saved project file with the current changes. If the file is being saved for the first time, the “Save As” dialog box will be displayed.

→ See “Project Files” on [page 34](#).

■ [Save as]

Saves the current project file as another file with a new name or in a new location. When you select this command, the “Save as” dialog box will be displayed.

→ See “Project Files” on [page 35](#).

■ [Import DME Designer All File]

Imports DME Designer All files (.dme extension).

→ See “Importing DME Designer All Files” on [page 46](#).

■ [Export DME Designer All File]

Exports the DME Designer All file (.dme extension).

→ See “Exporting DME Designer All Files” on [page 48](#).

■ [Import Device Configuration]

Imports parameters for a device that is arranged in a configuration file.

→ See “DME Data Import” on [page 42](#).

■ **[Export Device Configuration]**

Exports parameters of a device that is arranged in a configuration file.
→ See “DME Data Export” on [page 44](#).

■ **DME File Storage**

Opens the “DME File Storage” dialog box.
→ See “DME File Storage” on [page 70](#).

■ **Recently Used Files**

Displays recently saved files. If you click one of the file names, you can open that file.

■ **[Preferences]**

Opens the “Preferences” dialog box.
→ See “Preferences” on [page 72](#).

■ **[Log Off]**

Logs off the currently logged on user. Because the currently logged on user must be logged off before a new one can be logged on, the “Log On” dialog box will be displayed so you can log on the next user.
→ See “Users and Security” on [page 31](#).

■ **[Exit]**

Closes “DME Designer.” A confirmation message asking “Project file has been modified. Save?” will be displayed. To save, click [Yes]. To close without saving, click [No.]

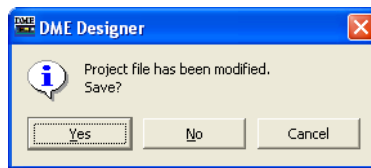

[Edit] Menu



■ [Undo]

Undoes a single operation. The name of the operation that will be undone by [Undo] is displayed in the command name. You can also select the commands that come after that. When [Undo] is not possible, the command will be grayed out.

■ [Redo]

Returns to the status before the [Undo] command was executed. The name of the operation that will be restored by [Redo] is displayed. You can [Redo] only as many operations as were undone with the [Undo] command. When [Redo] is not possible, the command will be grayed out.

■ [Undo History]

Opens the “Undo History” dialog box. Undoes multiple operations. Also deletes the history of operations.

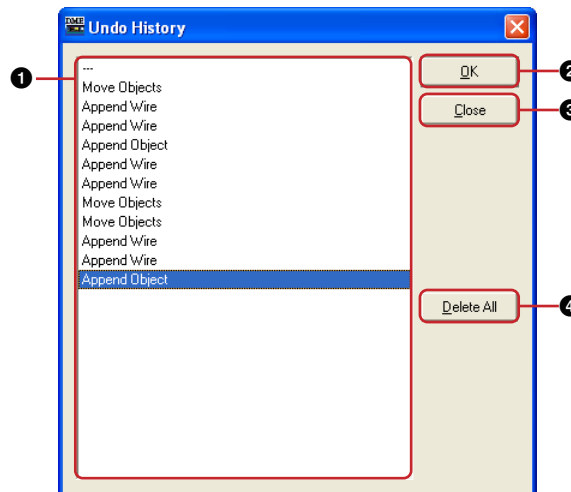

① List

Displays all operations performed so far, in order starting with the oldest. You can select an operation by clicking on it.

② [OK] Button

Undoes all operations below the one selected on the list. The operation selected on the list does not get undone.

③ [Close] Button

Closes the dialog box.

④ [Delete All] Button

Deletes the entire history of operations displayed on the list. When an operation is deleted from the list, it cannot be undone.

Operations undone from the [Undo History] can be re-executed one-by-one using [Redo].

[View] Menu



■ [Designer]

Displays or hides the Designer window.

■ [Event Logger]

Displays the network event log.

Not displayed if selected while the network event log is showing.

→ See "Event Logger" on [page 75](#).

■ [User Control]

This opens User Control.

The user controls that can be opened by the currently logged on user are displayed on a submenu.

If you click [New User Control] on the submenu, the "New User Control" dialog box opens.

→ See "User Control/User Module Editor" on [page 325](#).

NOTE

Controls that are not available to the currently logged-on user are not shown in the menu.

NOTE

The User Controls that are displayed when the DME Designer is launched can be set on the "User Control Manager" dialog box.

→ See "'User Control Manager' Dialog Box" on [page 91](#), [page 325](#).

■ [Navigator]

Displays or hides the Navigator window.

[Tools] Menu

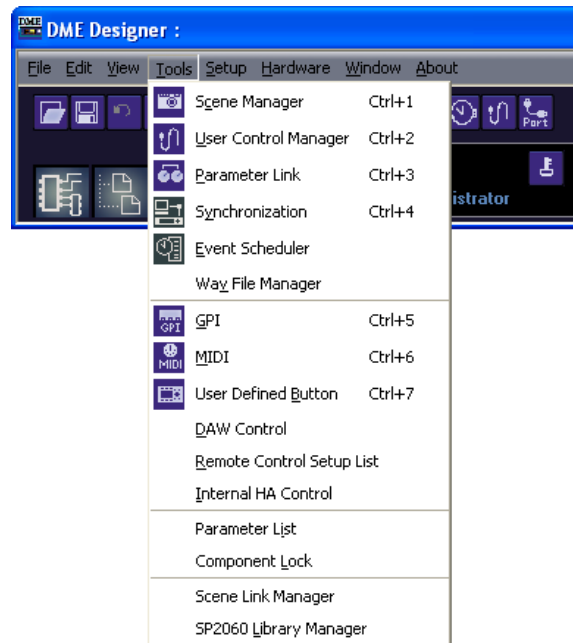

■ [Scene Manager]

Opens the “Scene Manager” dialog box.
→ See “Scene Manager” on [page 82](#).

■ [User Control Manager]

Opens the “User Control Manager” dialog box.
→ See “User Control” on [page 91](#), [page 325](#).

■ [Parameter Link]

Opens the “Parameter Link” window.
→ See “Parameter Link” on [page 94](#)

■ [Synchronization]

Opens the “Synchronization” dialog box.
→ See “Synchronization (DME Designer and Unit Synchronization)” on [page 97](#).

■ [Event Scheduler]

Opens the “Event Scheduler” dialog box.
→ See “Event Scheduler” on [page 101](#)

■ [Wav File Manager]

Opens the “Wav File Manager” dialog box.
→ See “Wav File Manager” on [page 108](#).

■ [GPI]

Opens the “GPI” dialog box.
→ See “GPI” on [page 112](#).

■ **[MIDI]**

Opens the “MIDI” dialog box.
→ See “MIDI” on [page 125](#).

■ **[User Defined Button]**

Opens the “User Defined Button” dialog box.
→ See “User Defined Button (User Defined Parameters)” on [page 132](#).

■ **[DAW Control]**

Opens the “DAW Control” dialog box.
→ See “DAW Control” on [page 136](#).

■ **[Remote Control Setup List]**

Opens the “Remote Control Setup List” Dialog box.
→ See “Remote Control Setup List” on [page 139](#).

■ **[Internal HA Control]**

Opens the “Internal HA Control” dialog box.
→ See “Internal HA Control” on [page 141](#).

■ **[Parameter List]**

Opens the “Parameter List” dialog box.
→ See “Parameter List” on [page 144](#).

■ **[Component Lock]**

Opens the “Component Lock” dialog box.
→ See “Component Lock” on [page 150](#).

■ **[Scene Link Manager]**

Allows scene link setup.
→ See “Scene Link Manager” on [page 151](#).

■ **[SP2060 Library Manager]**

Allows setup of SP2060 libraries.
→ See “SP2060 Library Manager” on [page 153](#).

[Setup] Menu



■ [Communication Port]

Opens the “Communication Port” dialog box.
→ See “Communication Port Setup” on [page 155](#).

■ [Shortcut Keys]

Opens the “Shortcut Keys” dialog box.
→ See “Shortcut Keys” on [page 156](#).

■ [Security]

Opens the “Security” dialog box.
→ See “Security (Creating Users and Making User Settings)” on [page 157](#).

[Hardware] Menu

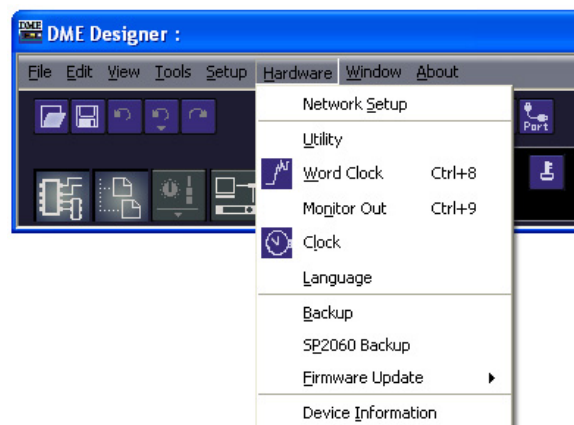

■ [Network Setup]

Opens the “Network Setup” dialog box.
→ See “Network Setup” on [page 165](#).

■ [Utility]

Opens the “Utility” dialog box.
→ See “Utility” on [page 167](#).

■ [Word Clock]

Opens the “Word Clock” dialog box.
→ See “Word Clock” on [page 177](#).

■ **[Monitor Out]**

Opens the “Monitor Out” dialog box.
→ See “Monitor Out” on [page 179](#).

■ **[Clock]**

Opens the “Clock” dialog box.
→ See “Clock” on [page 180](#).

■ **[Language]**

Opens the “Language” dialog box.
→ See “Language Settings” on [page 182](#).

■ **[Backup]**

Opens the “Backup” dialog box.
→ See “Backup” on [page 183](#).

■ **[SP2060 Backup]**

Opens the “SP2060 Backup” dialog box.
→ See “SP2060 Backup” on [page 184](#).

■ **[Firmware Update]**

Updates the DME, SP2060, or ICP1 firmware.
→ See “DME Firmware Update” on [page 186](#).

■ **[Device Information]**

Opens the “Device Information” dialog box.
→ See “Device Information” on [page 190](#).

[Window] Menu



Displays the open windows. Click a window name to bring that window to the front.

■ [Close All Editor Windows]

Closes all editor windows.

NOTE

Each design windows within the Designer window can be switched using the [Window] menu in the Designer window.

[About] Menu

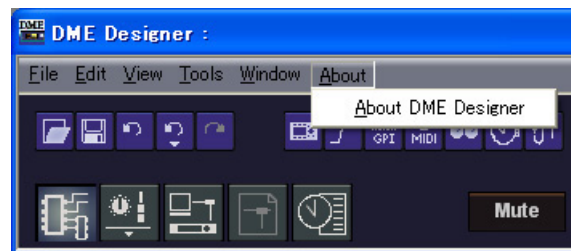

■ [About DME Designer]

Displays information about this application.

DME File Storage

Allows management of DME files. Project files can be managed on the DME, eliminating the need to manage them on the computer. Project files can be managed on a DME unit without the need for a computer. Since project files are necessary to allow synchronization of DME and SP2060 units, we recommend that you save your project files to the DME unit for enhanced reliability. Click [DME File Storage] in the [File] menu to display the “DME File Storage” dialog.

NOTE

Does not apply to SP2060 units

NOTE

If the file name is to include Japanese characters, select “Japanese” via the “Language” dialog box (page 182). If the file name is to include non-English Latin characters (Latin-1), select “English/German/French/Spanish”. Inappropriate combinations of file names and Language settings can make files unreadable in some cases.

Names and Functions

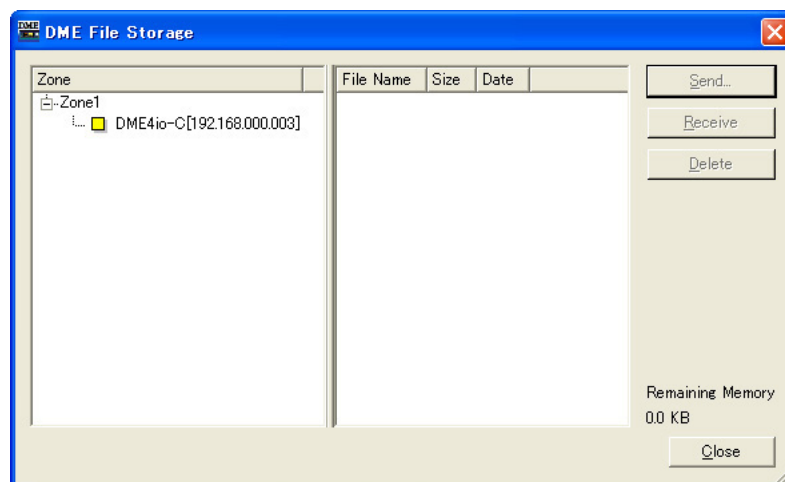

■ Zone List

Select the desired zone and device group and DME from the list.

■ File List

A list of the files stored on the selected DME.

■ [Send] Button

Transfers selected files from the computer to the DME.

■ [Receive] Button

Transfers selected files from the DME to the computer.

■ [Delete] Button

Deletes selected files from the DME.

■ [Close] Button

Closes the dialog box.

NOTE

Synchronization may become impossible if the [Remaining Memory] value (the amount of remaining DME memory) becomes too small. If this occurs, delete unwanted scenes or files to increase the amount of available memory.

Replacing the DME64N/24N startup screen

The screen image appearing when the DME64N/24N starts up can be replaced with a graphic file of your choice in the following way. This function allows you to display a desired startup screen—for example, one that includes your facility's name and logo.

■ Preparing the graphic data

Create the desired graphic data at a size of 160 x 48 dots in black-and-white bitmap format (extension .bmp) and save it as a file with the name “opening.bmp.”

■ Replacing the graphic data

Transmit the graphic file (“opening.bmp”) to the DME unit using the DME File Storage function from the DME Designer. This image will be displayed at the startup screen from the next time when the DME starts up.

NOTE

- To restore the default startup screen, create a dummy file and change the name to “blank.bmp.” and storage it in the same way as above. The default startup screen will be displayed from the next time when the DME starts up.
- The file transmitted to the DME unit using the DME File Storage function will be automatically erased after completing the internal configuration. This means the file is not stored on the DME unit.
- Compatible graphic files are limited to black-and-white bitmap format at a size of 160 x 48. Other graphic files cannot be displayed.
- The “Copyright” indication at the bottom of the screen cannot be erased.
- Only the DME64N/24N is compatible with this function. The ICP1 is incompatible.

Preferences

When you click the [Preferences] command on the [File] menu in the Main Panel window, the “Preferences” dialog box is displayed. Here you can make environmental settings for using DME Designer.

Names and Functions

■ [Application] Tab

Here you can set the general usage environment.

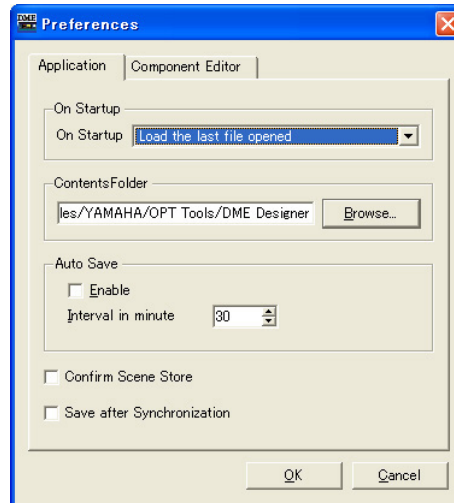

On Startup

Selects the action when the application starts up or a user logs on.

- [Load the last file opened]
Opens the last opened file. If the file cannot be found because it was moved, deleted, or its name was changed, a new project will be opened.
- [Create an empty file]
Opens a new project.
- [Load File & Synchronization]
Opens the last opened file and synchronizes with the DME or SP2060 unit.

Contents Folder

Specifies the folder in which common files that are not project dependent are saved. Click the [Browse] button to locate and specify the folder. The files listed below are saved in the specified folder.

- User module template files
- All types of library files
- Wave files
- Graphic files

NOTE

If the folder is changed, files that were stored in the previous folder will not be automatically moved or copied to the new folder. To carry the files over to the new folder, export the files as “DME Designer All” before changing the folder, then re-import the files after the new folder has been specified.

Auto Save

Set up the automatic file save feature.

This setting has no effect when the file being worked on has not previously been saved, or the computer is online.

- **[Enable]**
Auto save of project files being worked on will occur when checked. The file will be overwritten, but the Undo history will not be cleared.
- **[Interval in minutes]**
Specifies the auto-save interval in minutes.

[Confirm Scene Store]

Place a checkmark here to have a confirmation message displayed when storing a scene.

[Save after synchronization]

If a save is performed after the DME Designer is synchronized to the DME or SP2060 unit, the next synchronization will be significantly faster because one the difference needs to be synchronized. Check this checkbox to specify auto-save after the DME Designer is synchronized to the DME or SP2060 unit.

■ [Component Editor] Tab

Sets up operation of the Component Editor knobs, sliders, and edit boxes.

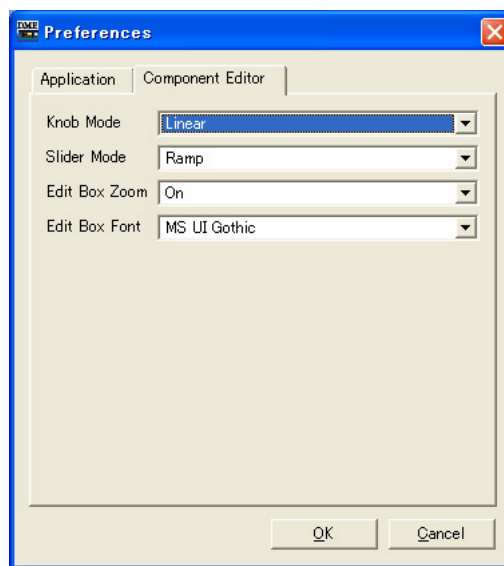

Knob Mode

Sets how the knobs operate.

- **Circular**
The knob is dragged following its shape, as though you were drawing a circle.
- **Linear**
As you drag the knob to the upper, the value increases. Dragging it down decreases the value.

Slider Mode

Sets the action that occurs when you click on the scale located under the sliders.

- **Ramp**

When the fader bar is clicked the knob will move a preset amount in the corresponding direction.

- **Touch**

The slider does not move without directly touching it, even if you click the mouse button.

- **Jump**

The slider jumps to the location where you click.

Edit Box Zoom

When "On" the edit box will enlarge on mouse-over.

Edit Box Font

When "On" the edit box will enlarge on mouse-over.

NOTE

This is the font when the box is enlarged, not the font that is used when the box is at its smallest size. The text may bleed beyond the box with some fonts.

NOTE

To make a finer setting, press the <Shift> key while dragging the slider.
If you click a slider while pressing the <Ctrl> key, the setting will return to its default value.

■ Common to All Tabs

[OK] Button

Applies any setting changes and closes the window.

[Cancel] Button

Closes the window without changing any settings.

Event Logger

Click [Event Logger] in the [View] menu to open the “Event Logger” window. This window displays the DME unit event log, and it allows specifying the log file to be stored on the computer as well as the log file to be store in the DME unit.

If the window is opened while online the event log is automatically retrieved from the DME unit and displayed as a list in the “Event Logger” window. New events are displayed in real time while the window is opened and the system is online. If [Enable Logging] in the “Log Setup” dialog box is ON, the event data will be written to the computer log file at the same time.

NOTE

Does not apply to SP2060 units.

NOTE

Only users for whom the [View Log Window] checkbox in the “Security” dialog box has been turned ON can display the “Event Logger” window. The default setting for this parameter is OFF.

NOTE

The events you wish to display in the Event Logger window must be set in advance in the “Event Log List” dialog box.

NOTE



Up to 1,536 events can be stored in the DME unit, while the maximum number of events that can be displayed in the “Event Logger” window is 12,288. When the DME unit even log becomes full, further events cannot be stored. When the DME event log does become full, use the “Get Log” dialog box to retrieve the event log and then click the [DME Log Clear] button to clear the DME unit log as necessary. If the “Event Logger” window event log becomes full, the oldest events are automatically deleted to make room for new events.

Periodically make [Enable Logging] in the “Log Setup” dialog box active so that the event log is saved as a file on the computer. This operation will automatically clear the DME unit event log.

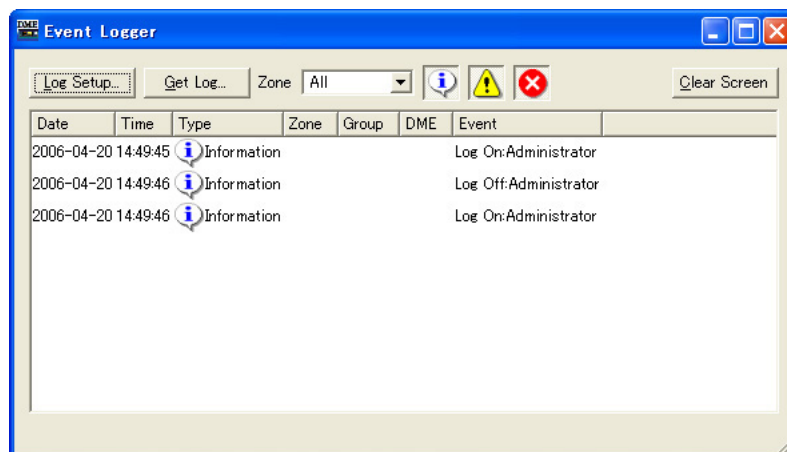
Names and Functions



■ DME List

- **[Date]**
Displays the date the event occurred. (Example Display: 2004-08-24)
- **[Time]**
Displays the time the event occurred.
- **[Type]**
Displays the event type and icon.
There are three event types:
 -  (Warning): Warning event
 -  (Error): Error event
 -  (Information): Other events
- **[Zone]**
Displays the name of the zone in which the event occurred.
- **[Group]**
Displays the name of the device group in which an event has occurred.
- **[DME]**
Displays the name of the DME in which the event occurred.
- **[Event]**
Displays the content of the event.

[Log Setup] Button

Displays the “Log Setup” dialog box ([page 77](#)). Here you can make Event Log settings.



[Get Log] Button

When offline, this opens the “Get Log” dialog box ([page 78](#)). The event log data can be taken from the DME units, and written to a file on the computer.

[Zone]

Selects the zone, device group and device for which events will be displayed. Only events from the selected device will be displayed in the window. If [All] is selected, events will be displayed for all.

Display button (Information/Warning/Error)

-  **[Display Information] Button**
Switches between displaying and hiding Information events.
When turned ON, Information events are displayed in the “Event Logger” window.
-  **[Display Warning] Button**
Switches between displaying and hiding Warning events.
When turned ON, Warning events are displayed in the “Event Logger” window.
-  **[Display Error] Button**
Switches between displaying and hiding Error events.
When turned ON, Error events are displayed in the “Event Logger” window.

[Clear Screen] Button

Clears the event log from the “Event Logger” window. The DME unit event log is not cleared.

“Log Setup” dialog box

Click the [Log Setup] button in the “Event Logger” window to display the “Log Setup” dialog box. Here you can make Event Log settings. These settings apply to the system as a whole.

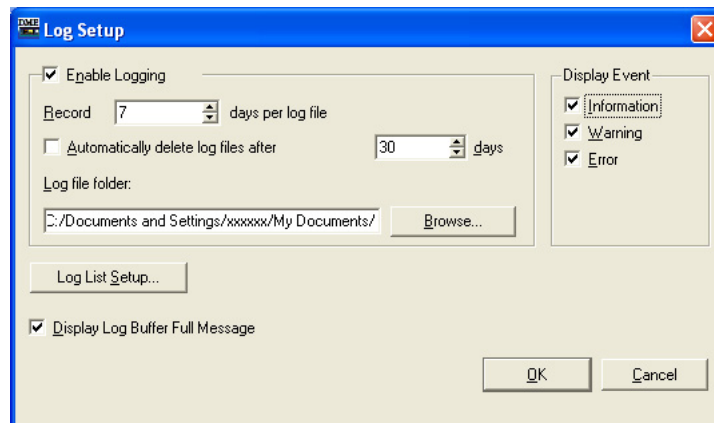

■ [Enable Logging]

Turns the function that writes the event log to a file ON or OFF.

When the checkbox is checked the event log is saved to a file, and the saved event log is cleared from the DME unit.

If the checkbox is unchecked the DME event log is saved in the DME unit.

When checked, it is set in the [Enable Logging] frame.

Record _ days per log file

Sets the number of days recorded into a single log file. When the specified number of days is exceeded, a new log file is created, and future log events are recorded there.

When “1” is set for the number of days at 10:00 AM, information will be recorded in the same file until the next day at 9:59 AM. The number of days counted is cleared and a new log file is created when the system goes online, or when the “Log Setup” dialog box is closed by changing the settings such as the number of days or the log file folder, and then clicking the [OK] button.

Automatically delete log files after _ days

When a check is placed here, log files exceeding the specified number of days are automatically deleted. Specifies the number of days after which log files are automatically deleted.

Log file folder

Specify the folder for saving log files. Clicking the [Browse] button opens the standard operating system dialog box for specifying folders. Here you can select a folder.

Log files are saved with the following file name: “LOG + Start_Date.txt”.

If there is a file with the same name already in the specified folder, a number will be affixed to the end of the file name, and it will be saved as a separate file. (Example: LOG20040824-2.txt)

■ [Display Event]

Displays events with checks next to them. This operates together with the [Display Information], [Display Warning], and [Display Error] buttons in the “Event Logger” window. You can place checks next to multiple events.

■ [Display Log Buffer Full Message]

This applies to DME64N/24N units in all zones. When checked, if the DME event log becomes full a “Log Buffer Full” message will appear on the display of the corresponding DME unit.

■ [Log List Setup] Button

Sets events sent from the DME units. Clicking here displays the “Event Log List” dialog box.

■ [OK] Button

Applies any setting changes and closes the window.

■ [Cancel] Button

Closes the window without changing any settings.

“Get Log” dialog box

Click the [Get Log] button in the “Event Logger” window while offline to open the “Get Log” dialog box. The event log can be retrieved from the DME unit while offline and saved as a file on the computer.

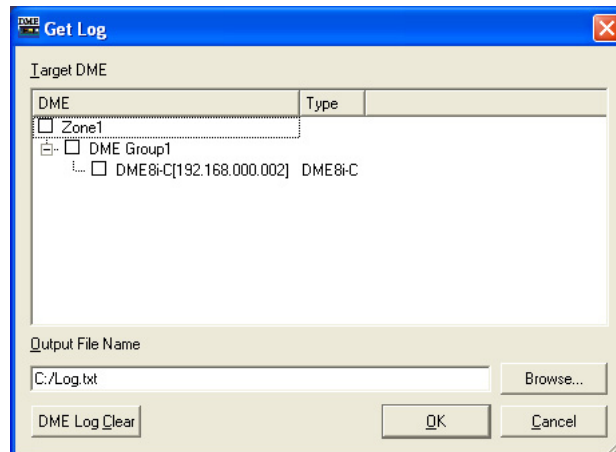

■ DME List

Displays the IP addresses and types of DME units included in the device group. Click the DME from which to obtain events by placing a check next to it.

■ [Output File Name]

Sets the file name and save location for the log file. Clicking the [Browse] button opens the file select dialog box, where you can select a file.

■ [DME Log Clear]

Clears (erases) logs in the DME units checked. When you click this button, a confirmation dialog is displayed.

■ [OK] Button

Applies any setting changes and closes the window.

■ [Cancel] Button

Closes the window without changing any settings.

“Event Log List” Dialog Box

Click the [Log List] button in the “Log Setup” dialog box to open the “Event Log List” dialog box. This allows selection of the events to be stored in each DME unit. Events not selected here will not be saved either in the DME unit or to a log file.

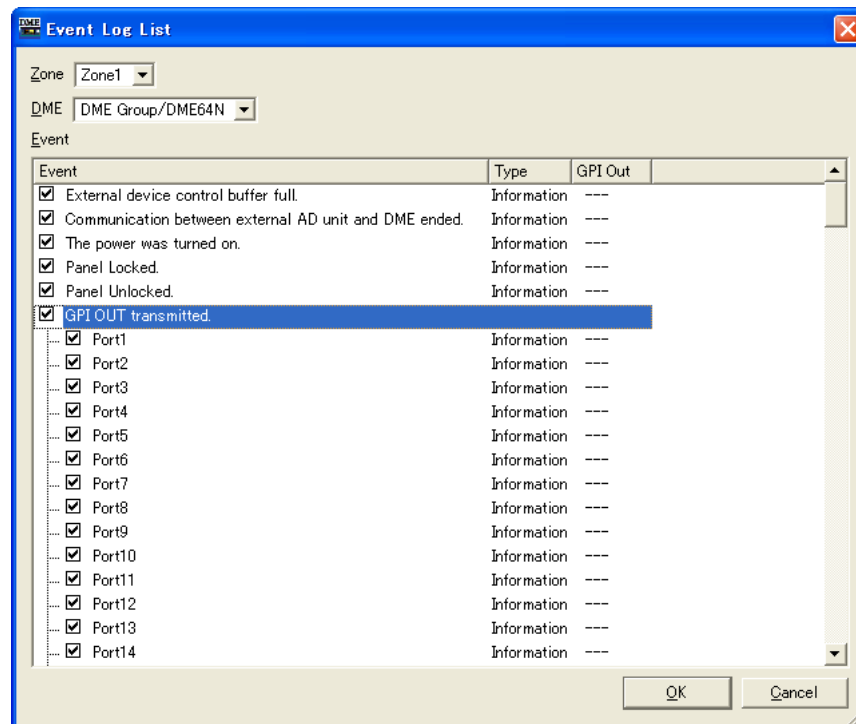

■ [Zone]

If you click here, a list will be displayed. Specifies a zone.

■ [DME]

If you click here, a list will be displayed. Specifies DMEs.

■ [Event]

Selects the events to be logged.

■ [Type]

Selects the event type for each event: [Information]/[Warning]/[Error].

■ [GPI OUT]

Specifies the port for event-triggered GPI output. If the same GPI port is specified for multiple events GPI output will be produced when any of the specified events occurs.

■ [OK] Button

Applies any setting changes and closes the window.

■ [Cancel] Button

Closes the window without changing any settings.

Event Log List

The event logs that can be retrieved from the DME unit as well as their content and countermeasures are listed below.

Displayed Messages	Contents/Countermeasures
Communication between PC and DME ended.	Communication between the computer and DME (device group master) has stopped. Check cable connections and router/hub operation.
Communication between PC and DME started.	Communication between the computer and DME (device group master) has started.
Communication between mixer (PM5D) and DME ended.	Communication between the mixing console (PM5D) and DME (device group master) has stopped. Check cable connections.
Communication between mixer (PM5D) and DME started.	Communication between the mixing console (PM5D) and DME (device group master) has started.
Communication between master DME and slave [IP:*.*.*.] DME ended.	Communication between the device group master DME and slave (IP Address: *.*.*) has stopped. Check cable connections and router/hub operation.
Communication between master DME and slave [IP:*.*.*.] DME started.	Communication between the device group master DME and slave (IP Address: *.*.*) has started.
Scene [***] recalled.	Scene number *** has been recalled.
Scene [***] stored.	Scene number *** has been stored.
DME Designer to DME unit synchronized.	A configuration has been transferred from DME Designer to the DME unit and synchronized.
MUTE was turned on. [IP:***]	DME (IP Address: *.*.*) turned the MUTE function ON.
MUTE was turned off. [IP:***]	DME (IP Address: *.*.*) turned the MUTE function OFF.
Input gain too high. AD [ChannelNo.*] Input gain too high. [SlotNo.*, ChannelNo.*] Input gain too high. CobraNet [ChannelNo.*] Input gain too high. EtherSound [ChannelNo.*]	The input signal (slot number/channel number will be displayed) has exceeded the clipping level. Reduce the input signal level or head amplifier gain.
Output level too high. DA [ChannelNo.*] Output level too high. [SlotNo.*, ChannelNo.*] Output level too high. CobraNet [ChannelNo.*] Output level too high. EtherSound [ChannelNo.*]	The output signal (slot number/channel number will be displayed) has exceeded the clipping level. Reduce the output signal level.
Scene store failure.	The scene data is protected. This may have been set by the administrator to prevent unwanted data changes due to improper operation. To change this setting turn "Protect" OFF in the "Scene Manager" dialog box.
Word clock unlocked.	An appropriate word clock is not being received or cannot be detected. Re-check the word clock connections and the "Word Clock" dialog box settings.
Word clock not synchronized. [Slot] (Slot*, Channel */*) Word clock not synchronized. [WC IN] Word clock not synchronized. [Cascade IN] Word clock not synchronized. [Cascade OUT]	The received word clock (input connector/slot number/channel number will be displayed) is not synchronized with the DME word clock. Revise the "Word Clock" dialog box settings so that an external word clock that is in sync with the DME word clock is received.
External word clock changed. [Fs=(*)kHz]	The external word clock (frequency: *kHz) has been changed.
Internal word clock changed. [Fs=(*)kHz]	The internal word clock (frequency: *kHz) has been changed.

Displayed Messages	Contents/Countermeasures
Communication between DME is busy and load is applied.	Heavy network traffic is causing communication delays. Check the devices connected to the network. It may be advisable to reduce the number of devices connected to the network. If the current link mode is 10Base-T, it may be advisable to upgrade to 100Base-TX
No Battery.	The backup battery is completely depleted or not connected. The current settings will be lost and the default settings restored when the power is turned off. Cease operation immediately and contact your Yamaha dealer.
Low Battery.	The backup battery is running low. This will not affect operation immediately, but if operation is continued current settings may be lost and the default settings restored. Contact your Yamaha dealer as soon as possible.
MIDI buffer full.	The MIDI receive buffer is full. Too much MIDI data may have been received.
Flash ROM full.	The flash memory used for data storage is full. Delete unneeded configurations, presets, and/or wave files.
GPI IN reception. [PortNo. *, AD(0-1023)= *]	A control signal (Level: *) has been received at the GPI IN terminal (Port number: *).
GPI OUT transmission. [PortNo. *->HIGH] GPI OUT transmission. [PortNo. *->LOW]	A high or low level control signal has been sent via the GPI OUT terminal (Port number: *).
Panel Unlocked.	Panel lock has been disengaged.
Panel Locked.	Panel lock is engaged so panel operations cannot be performed. Panel operation may have been locked by the administrator to prevent unwanted data changes due to improper operation. To unlock the panel press and hold the [CANCEL] button for longer than 2 seconds.
The power was turned on.	DME power has been turned on.
Communication between external AD unit and DME ended.	Communication between the external head amp unit and DME device has stopped. Check cable connections.
External device control buffer full.	The receive buffer for control commands from external devices has become full. Too much control may have been received.
Invalid password.	An incorrect password has been entered via the panel. If you have forgotten the correct password contact your Yamaha dealer.
Current Settings lost.	The memory has been erased and current settings have been lost. Try a scene recall. If that doesn't rectify the problem contact your Yamaha dealer.
Network hardware error.	A network device error has occurred. Contact your Yamaha dealer.
Duplicate IP address.	Duplicate IP address. Set IP addresses so that no two devices with the same address are connected to the network.
DSP power shortage.	Audio input/output has been muted due to insufficient DSP resources. This can occur if a configuration created for 48kHz word clock is run at 96kHz. To ensure full word clock operation, create configurations with word clock set to 96kHz.

Scene Manager

Scenes

Configuration contents can be given a name and saved as “**Scenes.**” Saving scenes is called “**Scene Store.**” Parameter settings in the configuration for each site used can be stored multiple times and recalled and used when needed. There are 999 scene memories available. When a scene is stored, DME and SP2060 parameters are saved as “**preset parameters.**” Presets are automatically created when a scene is stored.

Bringing back a scene (making a scene the current scene) is called “**scene recall.**” Scenes are recalled using the [▼] button next to the current scene on the Main Panel window or by using the “Scene Manager” dialog box.

■ “Scene Manager” Dialog Box

Click either the [Tools] menu [Scene Manager] item or the “Scene Link Manager” window [Scene Manager] button to open the “Scene Manager” window that allows editing of scene data. Scene names, security levels, and presets can be changed and copy/pasted as required. The DME scene memory is comprised of 999 user memories, while the SP2060 has 12 preset memories and 87 user memories. The preset memories are read-only, while settings and changes can be stored to the user memories as required.

NOTE

Security for the Logged On User

The currently logged on user can store, recall, or edit scenes that have a security level equal to or lower than his or her own. User security levels are set with the [Edit] → [Store/Recall/Edit] item in the “Security” dialog box.

NOTE

There is no [OK] button or [Cancel] button in the “Scene Manager” dialog box. To close the dialog box, click the [Close] button at the upper-right of the dialog box.

Changes from storing/recalling scenes or editing, such as changing names or contents, will be applied immediately. With the dialog box open, you can make the Designer window active and add components or change parameters.

Names and Functions

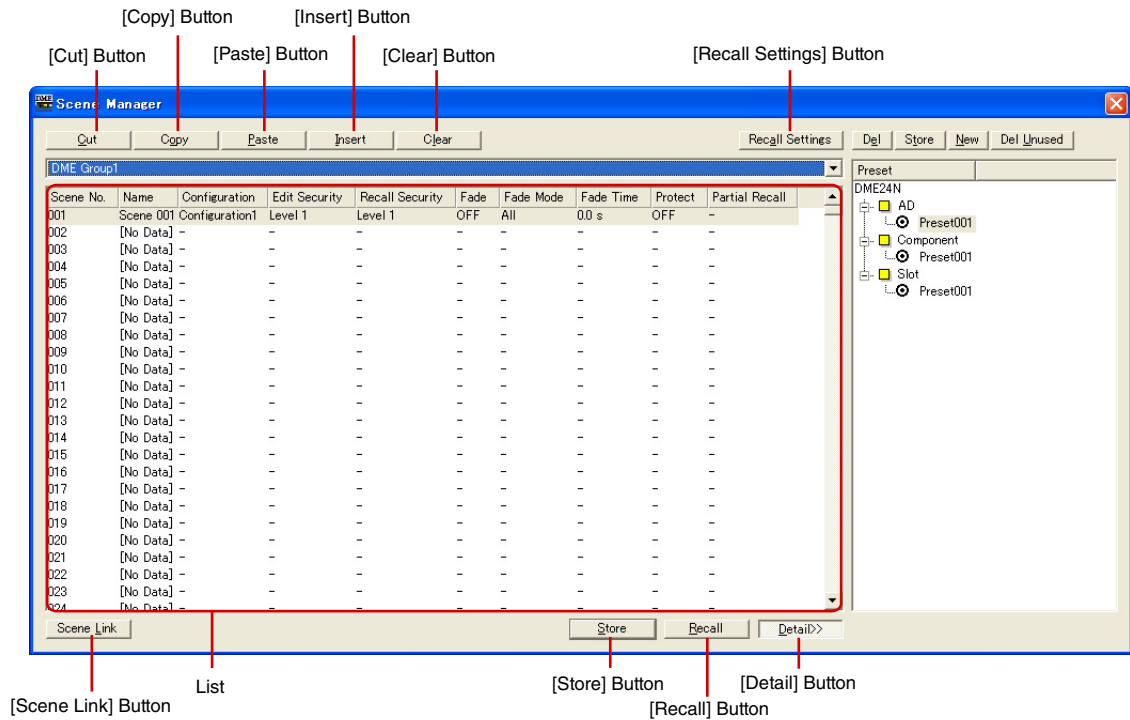

■ DME Group/SP2060 Selection

Selects a DME group or SP2060.

NOTE

The selected DME group or SP2060 is linked with the current device group.

■ List

Displays the contents of the scene.

Scene No.

Displays the scene number. Click here to select a scene.

Name

Displays the name of the scene. Click the [Name] box to enter a scene name. Up to 18 characters can be entered.

If the scene has not been stored, “[No Data]” will be displayed. A name can be entered when a scene is stored. The default names are “Scene001,” “Scene002,” etc. The three-digit number is the same as the scene number (displayed in [Scene Number]) for the stored scene.

NOTE

The SP2060 display can only display up to 16 single-byte characters. Some characters that appear correctly on the DME Designer may change when displayed on the SP2060 display. For example, a backslash character will appear as a yen symbol on the SP2060 display.

Configuration

Displays the configuration name. If the scene has not been stored, a hyphen (-) will be displayed.

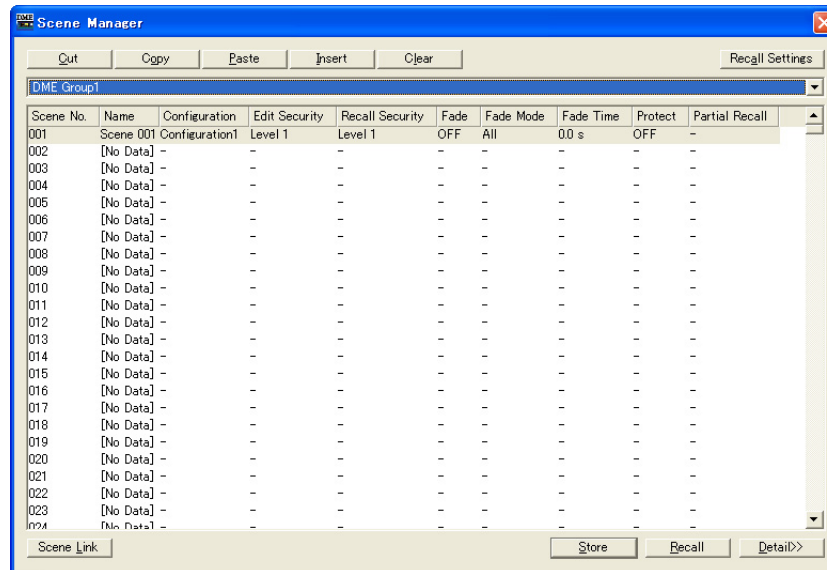

Edit Security

Displays the scene edit security levels. Clicking here will display a list where you can change these security levels. Only levels at or below the security level of the currently logged on user are displayed in the list. Scenes are stored with the same security level as the user, but their store and edit security levels can be set lower if required.

Recall Security

Displays the scene recall security level. Clicking here will display a list where you can change the security level. Only levels at or below the security level of the currently logged on user are displayed in the list. Scenes are stored with the same security level as the user, but their recall security levels can be set lower if required.

Fade

It sets whether fade is applied (ON) or not (OFF) when a scene is recalled.

When "ON" the faders in fader components will "fade" to their new settings according to the specified fade mode and fade time when a scene is recalled. This only applies to fader components.

NOTE

The fade function cannot be simulated in DME Designer.

Fade Mode

Sets the fade mode. You can select "All" or "Selected."

If you select "All," all channels using Fader components in their configuration will be affected. Even when multiple components are used, all channels are targeted. If you select "Selected," the only channels affected will be those for which the Fade switch in the component editor has been set to ON.

NOTE

The Fade switch for each channel is set to OFF by default. The fade effect will not be applied, even if Fade=ON and Fade Mode=Selected is selected. To apply the effect, you must set the Fade switch to ON for the channels where you need it.

Fade Time

Sets the fade time: i.e. the time it will take fader parameters to reach their new settings when a scene is recalled. The changes are smooth and continuous. If only the presets in the recalled scene are set when that scene is recalled, the volume will be adjusted while the sound from the previous scene is playing, until the new level is reached. If the configuration also changes, the volume will rise from silence until it reaches the new value. This can be set from zero to 60 seconds, in 0.1 second increments.

Protect

Turns the Protect function ON or OFF.

When ON scene data cannot be deleted, overwritten, edited, or renamed.

NOTE

Right-click in the list and use the contextual menu that appears to set User Defined Button, Program Change, GPI In, or GPI Out for the scene.

Partial Recall

Partial Recall sets created in the [Partial Recall] tab (page 87) accessed from the “Recall Settings” dialog box can be selected for each scene.

■ [Cut] Button

Cuts the scene selected on the list. The button will be grayed out and cannot be used when the unit is online or when an SP2060 preset is being used.

■ [Copy] Button

Copies the scene selected on the list. The button will be grayed out and cannot be used when the unit is online.

■ [Paste] Button

Pastes the contents of the cut or copied scene into the scene selected on the list. Cuts the scene selected on the list. The button will be grayed out and cannot be used when the unit is online or when an SP2060 preset is being used. The selected scene will be overwritten.

■ [Insert] Button

Inserts the contents of the cut or copied scene into the location of the scene selected on the list. The selected scene and those below are moved down by one. For example, if “Door_Open” was stored as scene number “005,” and selected when the [Insert] button was clicked, the inserted scene would become scene number “005,” and “Door_Open” would be moved to scene number “006.”

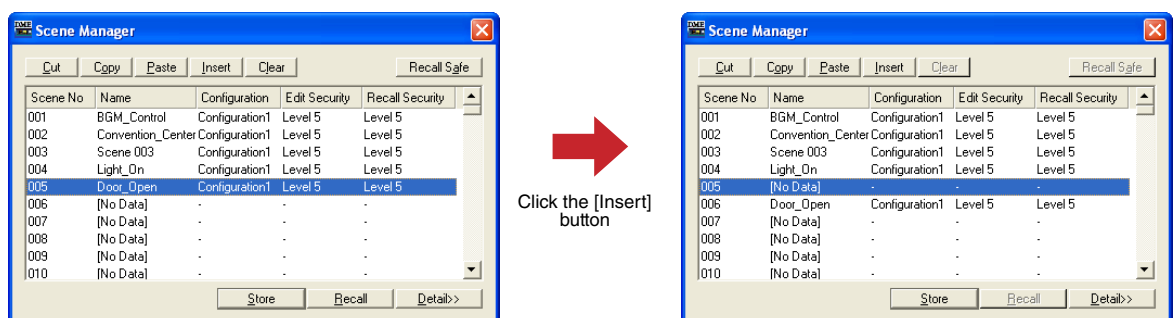

If a scene is stored in the lowest scene on the scene memory list, the button will be grayed out and the insert function will not be available. Delete the contents of the lowest scene before attempting to use the insert function.

NOTE

Move the scene data to a different scene memory when you don't want to erase the contents of the lowest scene.

■ [Clear] Button

Deletes the contents of the scene selected on the list. The button will be grayed out and cannot be used when the DME unit is online or when an SP2060 preset is being used. If the preset parameters included in a scene are not used in another scene, a “Delete preset?” message will be displayed.

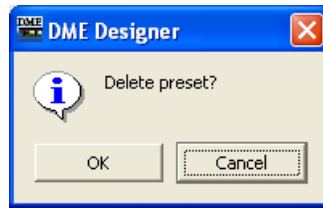

If the preset parameters are not needed, click the [OK] button. If you click the [Cancel] button, the preset parameters will not be deleted. Whichever you click, the scene itself will be deleted.

NOTE

The [Cancel] button on the “Delete Preset?” message does not cancel the [Clear] for the scene. It merely cancels deletion of the presets.

■ [Recall Settings] Button

This button opens the “Recall Settings” dialog box.

Recall Safe and Partial Recall

Recall Safe and Partial Recall parameters can be set up so that only specified components are recalled, or specified components are omitted, with a scene is recalled. Recall Safe specifies the components that will be omitted (i.e. not recalled) when a scene is recalled. Recall safe settings can be made independently for each configuration, and apply to all scenes that use the same configuration.

Conversely, Partial Recall specifies the components that will be recalled when a scene is recalled. Partial Recall “sets” can be saved for use with single or multiple scenes.

The Recall Safe and Partial Recall settings are accessed via the [Recall Safe] and [Partial Recall] buttons, respectively.

[Recall Safe] Tab

The components that will not be recalled when a scene is recalled are selected via this tab.

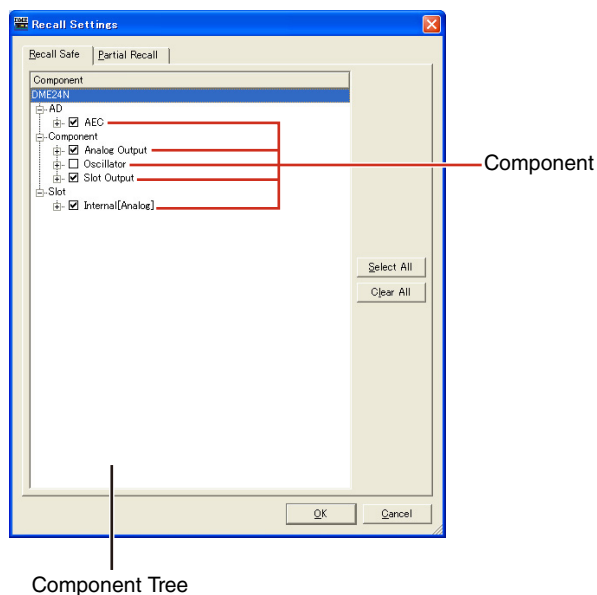

- **Component Tree**

Displays all components included in the scene. Check the checkboxes to the left of the components that you do not want to recall when a scene is recalled.

NOTE

Components that are checked in the [Recall Safe] tab component tree will not be recalled. If you want all components to be recalled there is no need to make any settings in this tab.

This function is useful when you want most of the scene's components to be recalled normally while preventing specified components from being recalled.

[Partial Recall] tab

In this tab you can select only the components you want to be recalled when a scene recall operation is carried out. All other (unchecked) components will not be recalled. The selections made here can be saved as sets. Saved sets can be used with multiple scenes, copied, and edited as required.

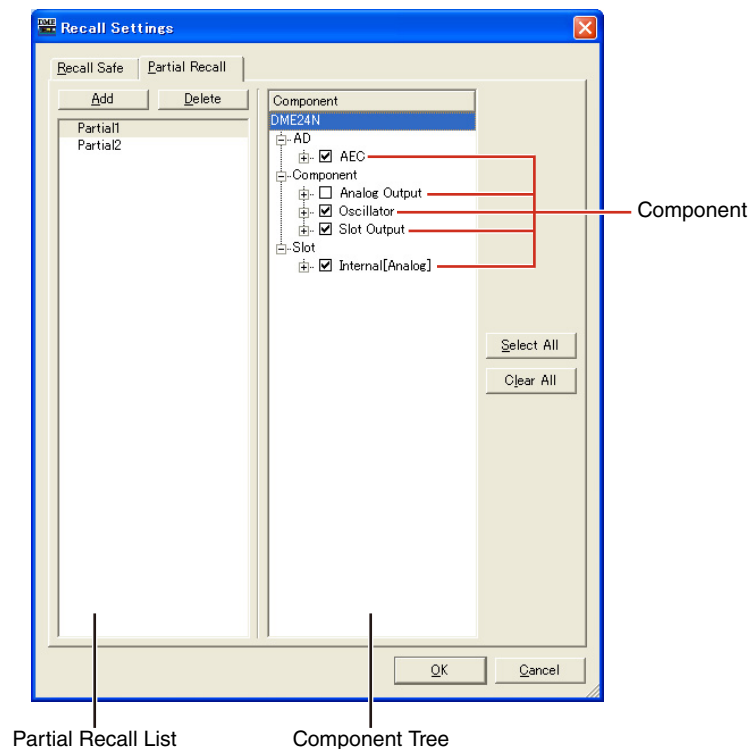

- **Component Tree**

Displays all components included in the scene. Check the checkboxes to the left of the components that you want to be recalled when a scene is recalled.

- **Partial Recall List**

Displays the sets of Partial Recall components settings that have been saved. Up to 64 Partial Recall sets can be saved for each configuration. Saved sets can be selected via the "Partial Recall" menu in the "Scene Manager" dialog box.

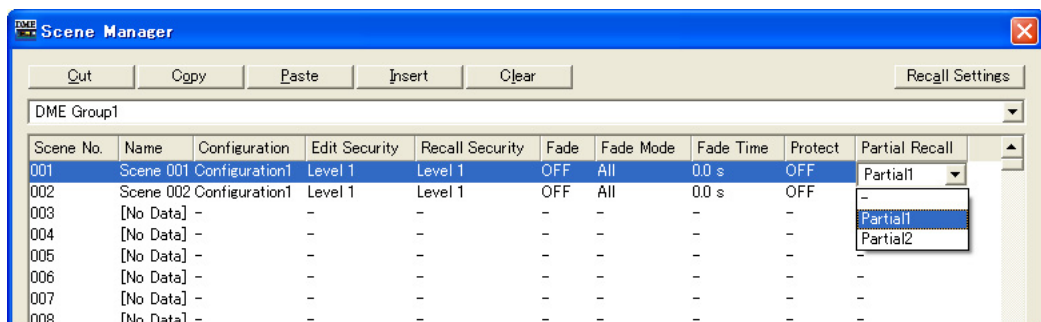

Click the [Add] button to create a new set with all components selected.
 Click the [Delete] button to delete the currently selected set from the list.
 Right-clicking in the Partial Recall list displays a contextual menu that provides access to the following operations:

Add: Add a new set with all components selected (same function as the [Add] button).

Delete: Deletes the currently selected set (same function as the [Delete] button).

Cleanup: Deletes sets that are not being used in the current scene.

Rename: Allows a new name to be entered for the selected set.

Copy: Copies the contents (component selections) of the currently selected set.

Paste: Pastes copied contents to the currently selected set.

Duplicate: Creates a duplicate copy of the currently selected set.

NOTE

Appropriate icons appear to the left of Partial Recall set names when the set is being used by a scene, and when the scene the set is being used by is protected. Partial Recall sets that are being used in a scene cannot be deleted.

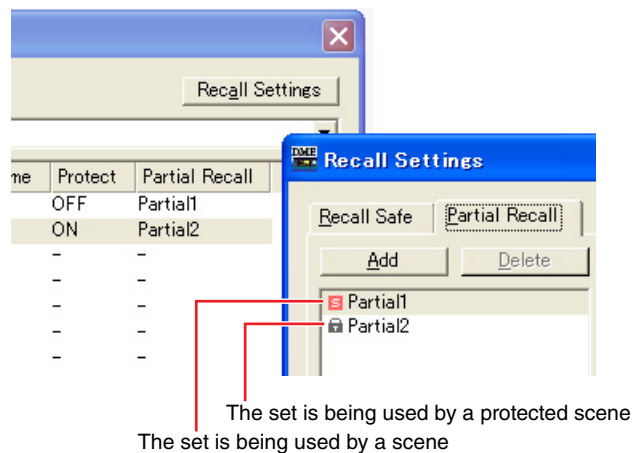

NOTE

Partial Recall sets cannot be created or edited while online.

Common Tab Functions

- **[Select All] Button**
Checks all components.
- **[Clear All] Button**
Unchecks all components.
- **[OK] Button**
Applies any settings that have been made and closes the dialog box.
- **[Cancel] Button**
Closes the dialog box without applying or saving any settings.

NOTE

If the same component is checked in both the Recall Safe and Partial Recall tabs, the Recall Safe function takes priority and that component will not be recalled.

NOTE

When a scene that includes Local Link or Component Link settings made via the Parameter Link window ([page 94](#)) is recalled, the linked parameters are recalled.

■ [Store] Button

Stores the contents of the current configuration into the scene selected in the list. If an empty scene is selected and the contents stored there, a new scene is created. If a scene is already stored in the selected scene number, it will be overwritten. If [Confirm Scene Store] is checked on the [Application] tab of the “Preferences” dialog box, a confirmation message will be displayed before the scene is stored.

NOTE

The currently logged on user can store scenes at a security level equal to or lower than his or her own only.

NOTE

When the computer and DME/SP2060 unit are online, a scene stored in the DME Designer will also be stored on the DME or SP2060 unit, regardless of the DME or SP2060 settings.

The DME64N/24N utility display Misc. page [Scene Store] setting only affects store operation from the DME panel controls.

When a scene is stored, the configuration parameters at that time are saved as “preset parameters.” Preset parameters are created automatically.

■ [Recall] Button

Recalls the scene selected in the list and makes it the current scene.

NOTE

The currently logged on user can recall scenes at a security level equal to or lower than his or her own only.

■ [Detail] Button

Expands the dialog box and displays a preset parameters list. If you click the preset parameters list while it is displayed, the preset parameters list will be hidden. When the dialog box is opened, its status will be the same as the last time it was closed.

NOTE

Not available for SP2060 groups.

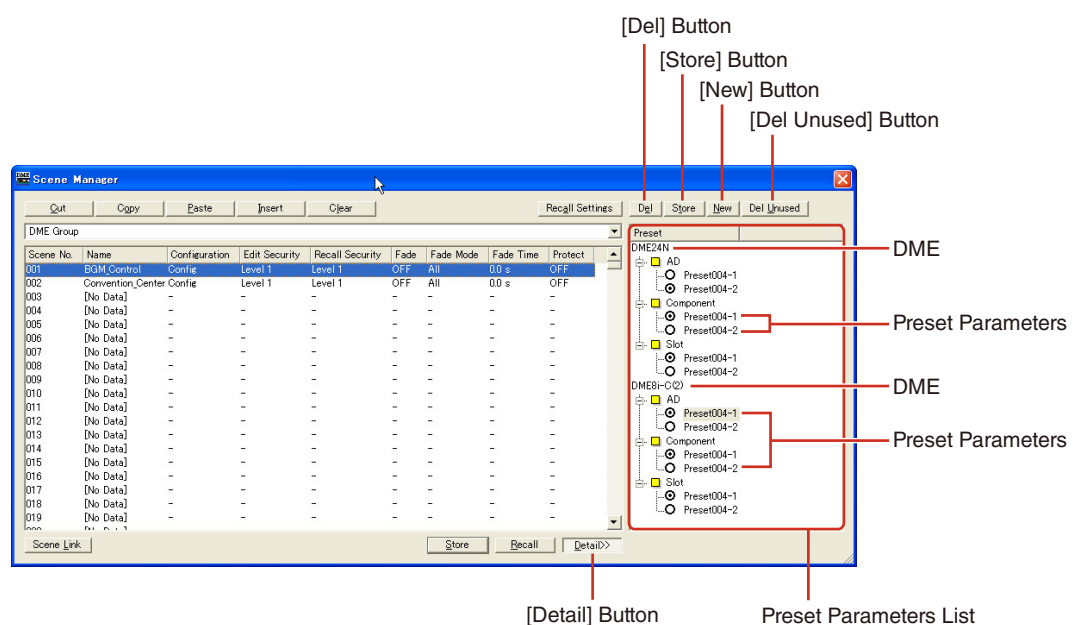

■ Preset parameters List

Displays the preset parameters for each DME unit in the scene selected in the list. When another scene is selected on the list, the contents of the preset parameters list will be changed.

You can change the preset parameters used in the scene by clicking the radio buttons to the left of the preset parameters names. You can also create, delete, and store preset parameters or change their names.

DME

Displays the DME. Below the DME there are [Slot], [Component], and [AD]. If there are preset parameters below them, a [+] button will be displayed. When you click the [+] it becomes a [-] and the presets are displayed.

Preset parameters

Displays DME preset parameters.

If you click the preset parameters name, selecting the text that is there, you can change the preset parameters name. When preset parameters are automatically created when a scene is stored, they are named "Preset001," "Preset002," and so on. preset parameters created with the [New] button are named "New Preset."

You can select the preset parameters used in a scene by clicking the radio buttons to the left of the preset parameters names.

■ [Del] Button

Deletes the preset parameters selected on the preset parameters list.

NOTE

Presets used in a scene cannot be deleted.

■ [Store] Button

Stores the current parameter status in the preset parameters selected in the preset list. The contents of the selected preset parameters will be overwritten.

■ [New] Button

Stores the current status and creates a new preset parameters. The newly created preset parameters is named "New Preset1", "New Preset2" etc.

■ [Del Unused] Button

Deletes unused preset parameters from DME units in the selected device group.

■ [Scene Link] Button

Opens "Scene Link Manager" dialog box.

Refer to "Scene Link Manager" on [page 151](#)

User Control

User Controls

You can create an original control by arranging knobs and sliders in the component editor. Controls you create are called “**user controls.**”

Those created user controls are displayed in the [View] → [User Control] submenu in the Main Panel window

Refer to “User Control Editor/User Module Editor” on [page 325](#) for information on user control editing.

“User Control Manager” Dialog Box

When you click [User Control Manager] on the [Tools] menu, the “User Control Manager” dialog box is displayed. This dialog box displays a list of user controls included in the configuration of the current device group. There they can be created or deleted. You can also edit the name and security level of user controls here.

NOTE

Security for the Logged On User

The currently logged-on user can create and edit the user controls of all users at lower security levels as well as the controls specified for that user. Available user controls are displayed in the User Control manager dialog box that can be accessed through the [User Control] sub-menu of the main panel window [View] menu.

The user control security level for each user is set with [Operation Security] → [User Control Level] in the “Security” dialog box. For information about user security, see [page 157](#).

Names and Functions

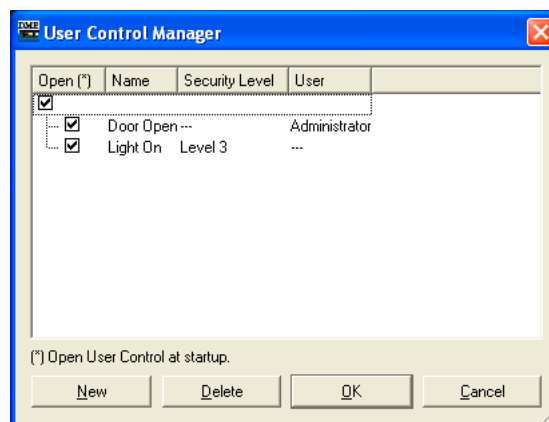

NOTE

Only controls available to the currently logged on user are shown in the list.

■ Open

If this checkbox is checked, the user control will open automatically when the project file is opened.

■ Name

Displays the names of the user controls. Clicking here will select the characters in the name, allowing you to change it.

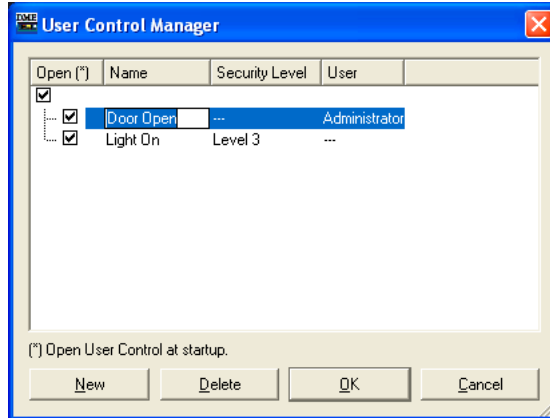

■ Security Level

Displays the security level set for each user control. Clicking here will display a list where you can change the security level.

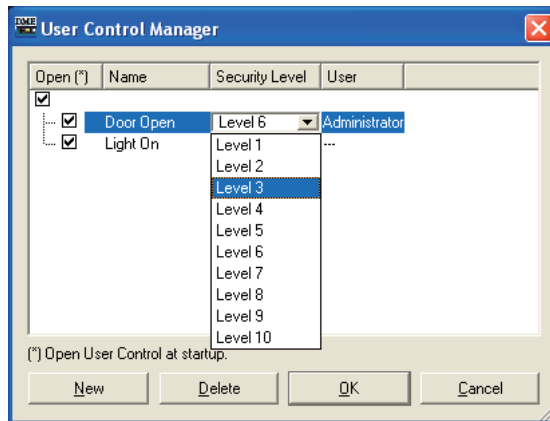

■ User

Displays the name of the user specified in User Control. Clicking here will display a list of the available users.

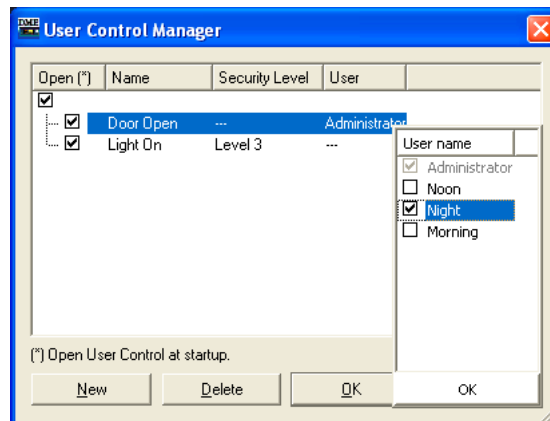

■ [New] Button

Creates new user controls. Clicking here displays the “New User Control” dialog box.

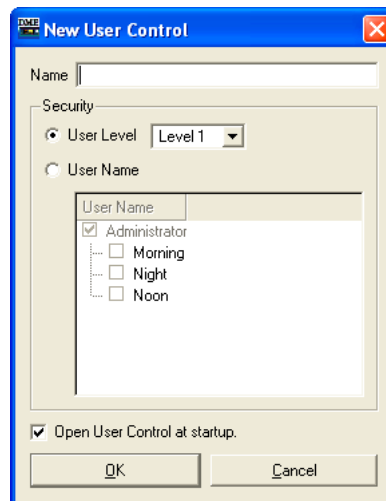

Enter the User Control name in the [Name] box.

[User Level]/[User Name]

Use the radio buttons to the left to select security-level or user dependent control.

- [User Level]
Select a security level from the drop-down list.
- [User Name]
Check a checkbox.
Click [OK] to create the specified User Control setup.

[Open User Control at startup]

If this checkbox is checked, the user control will open automatically when the project file is opened.

■ [Delete] Button

Deletes the user control selected on the list.

■ [OK] Button

Accepts the changed settings and closes the dialog box.

■ [Cancel] Button

Closes the dialog box without changing the settings.

Parameter Link

About Parameter Links

You can group parameters of the same type and link them. These groups are called “Parameter Links.” When one parameter in a parameter link group is changed, all parameters in the parameter link group will change in the same way.

There are three parameter link types: global links, local links and component links. Global links link parameters for DMEs within a device group. Local links and component links link parameters that are included for a single DME.

NOTE
Parameters can not apply to multiple groups.

NOTE
When a library is recalled, the linked parameters in other components will not change even if parameter linking is enabled.

Groups can be created and parameters added to groups in the user control/user module control editor and component editor. For information about creating parameter links, see “Creating Parameter Links” on [page 368](#).

You can check the status of parameter links and edit them in the Parameter Link window.

Parameter Link Window

When you click [Parameter Link] in the [Tools] menu, the “Parameter Link” window is displayed. You can also display the window by selecting [Open Parameter Link] from the context menu displayed in the user control/user module editor and component editor.

Names and Functions

[Global Link] button/[Local Link]/[Component Link] buttons

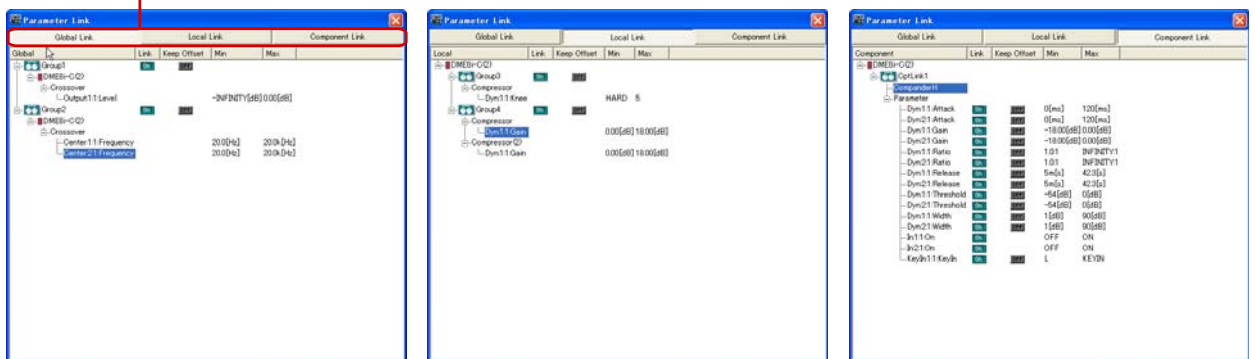

[Global Link] button/[Local Link] button/[Component Link] button
Switches the window display.

- **Global Link**
Links to the parameters of multiple DME units in the zone.

NOTE
Recall Safe and Partial Recall settings ([page 86](#)) do not apply to linked parameters when a scene is recalled.

NOTE
Because there is a large load on the network, the maximum number of Global Links will be limited to eight.

- **Local Link**
Links to the parameters of one DME unit.

NOTE

When a scene is recalled using Recall Safe or Partial Recall settings (page 86), linked parameters will be recalled with the same settings.

- **Component Link**
Links component parameters of the same type within a single DME unit.

NOTE

When a scene is recalled using Recall Safe or Partial Recall settings (page 86), linked parameters will be recalled with the same settings.

NOTE

Component Link cannot be used with SPX components.

Parameter Link Group List

Displays a hierarchical list of parameter link group and the parameters that belong to them. When a parameter link group name is selected, the controls that belong to that parameter link group are selected.

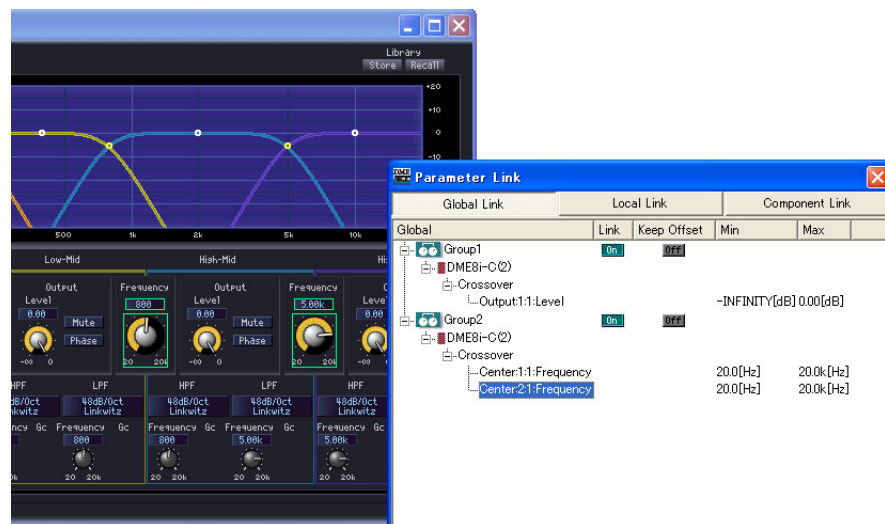

- **Group Name**
You can select a parameter link group name by clicking on it. Clicking the selected parameter link group name again will select the characters in the name, allowing you to change it. Clicking the plus (+) or minus (-) sign to the left of the parameter link group name displays or hides items that belong to that parameter link group. You can delete a parameter link group by selecting it and pressing the <Delete> key. You can also delete a parameter link group by right-clicking on the parameter link group name and selecting [Delete] in the context menu that is displayed.
- **DME Icon**
Displays the DME that includes the parameters that belong to a parameter link group. The components can be displayed or hidden by clicking the plus (+) or minus (-) signs for the DME icon. The parameters, Min, and Max can be displayed or hidden by clicking the plus (+) or minus (-) signs for the component.
- **Link**
Click to turn ON or OFF. Turn OFF to disable parameter linking. Component linking for multiple parameters can be turned ON or OFF via the contextual menu that appears when the group name is right-clicked.

- **Keep Offset**

Click to turn ON or OFF. When “ON” the parameter offset is maintained so that when any parameter in the group reaches its minimum or maximum value, further decrease or increase is not possible.

Keep Offset for multiple parameters can be turned ON or OFF via the contextual menu that appears when the group name is right-clicked.

- **Parameter**

Displays the parameters that belong to a parameter link group. You can display or hide minimum and maximum values for a parameter by clicking the plus (+) or minus (-) signs.

You can delete a parameter from a parameter link group by selecting the parameter name and pressing the <Delete> key.

NOTE

Components for user modules are also listed in a hierarchical display, but if user module security is enabled, the components are not displayed. However, parameters displayed in the user module editor are displayed here.

Synchronization

(DME Designer and Unit Synchronization)

The DME or SP2060 unit and DME Designer are synchronized by Synchronization. The DME or SP2060 operates according to the configuration and scene information transferred during this process.

This Synchronization is used when transferring the configuration in DME Designer and when controlling the DME or SP2060 unit in real time.

NOTE

Because Synchronization presupposes that the DME or SP2060 unit can communicate with the computer where DME Designer is installed, the necessary drivers (USB-MIDI or DME-N Network Driver) must be installed, and appropriate settings must be made for the driver and for DME Designer communication ports ([page 155](#)).

For information about driver installation and settings, see "DME Setup Manual". For DME Designer communications settings, see "Online" ([page 50](#)).

NOTE

Because there are no scene settings when the DME unit is purchased, the configuration and scene information in DME Designer must first be transferred.

NOTE

When combining DME64N/24N and DME Satellite units in a device group, be sure to assign a DME Satellite unit as the device group master. Synchronization cannot be performed if a DME64N/24N is assigned as the device group master.

NOTE

For information about the online procedure, see "Online" ([page 50](#)).

Online and Offline

When a DME or SP2060 unit is connected to the computer and synchronized with DME Designer, its status is called "**Online**." When a DME or SP2060 unit is not physically connected to the computer or is not synchronized even when it is connected, its status is called "**Offline**." You can check the online/offline status and message transmission in [Communication Status] in the Main Panel window.

■ Online

Sends configurations created in DME Designer to the DME or SP2060 unit and reads data from the DME or SP2060 unit, so that the DME unit configuration is reflected in the DME Designer configuration. You can also control the DME or SP2060 in real time from DME Designer. Operations performed in the DME Designer control editor are reflected in the DME or SP2060 unit, and operations on the DME or SP2060 side are reflected in DME Designer.

You can not perform configuration editing using the Designer while online.

■ Offline

The communication status becomes offline when editing configurations.

■ Switching Between Online and Offline

You can switch between online and offline in the "Synchronization" dialog box.

NOTE

For information about the online procedure, see "Online" ([page 50](#)).

“Synchronization” Dialog Box

When you click the [Synchronization] command on the [Tools] menu, the “Synchronization” dialog box is displayed. The data from the current device group in the Designer is synchronized with the DME or SP2060 unit.

Here you can make settings for synchronizing the unit in DME Designer one-on-one with the DME or SP2060 that actually exists on the network.

NOTE

When synchronization is executed the connections, components, and other data are automatically checked as part of the compilation process. A progress bar will appear during compilation, but in some cases it may not exactly match the progress of the compilation process. Also, the appearance of the progress bar is no guarantee that compilation will be completed successfully. If compilation continues for an inordinately long period of time, click the [Abort] button to stop processing. Try eliminating unnecessary components and connections, and replacing components that place a heavy load on resources with more efficient ones, then compile again.

NOTE

The Analyze function (page 308) can be used to check whether there are any problems with component layout or connections without having to actually connect the DME unit. This is a convenient way to check for compile errors that might occur at the time of synchronization.

NOTE

Once a configuration has been analyzed or compiled successfully, subsequent analysis or compilation will run quicker unless changes are made to the configuration. Also, if you save the project file the analysis/compilation data is saved as well.

Names and Functions

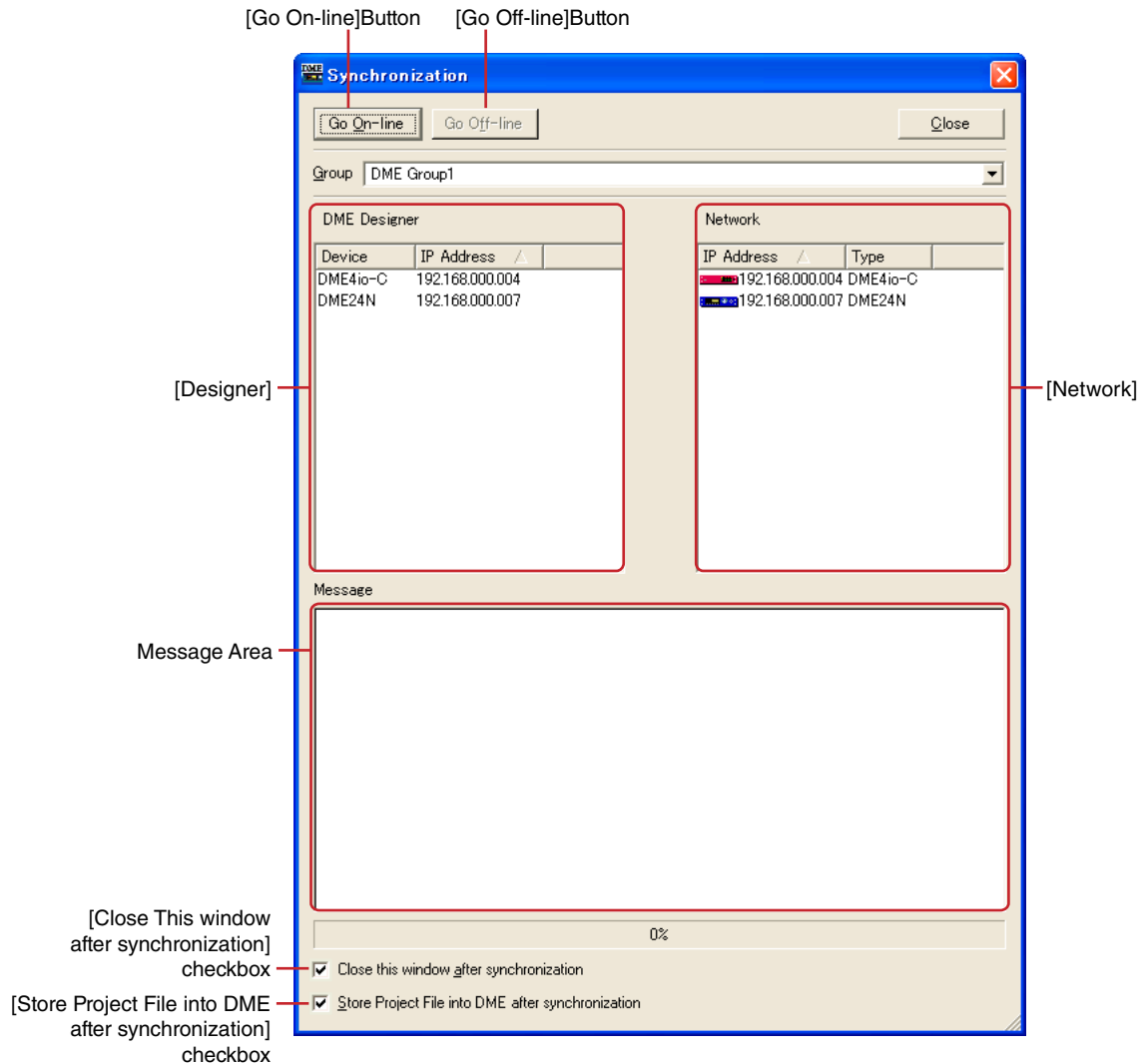

■ [Group] List

Allows selection of a device group to be synchronized.

■ [Go On-line] Button

This button will be grayed out when the software is online.

Clicking the button displays a dialog box where you can decide the synchronization method.

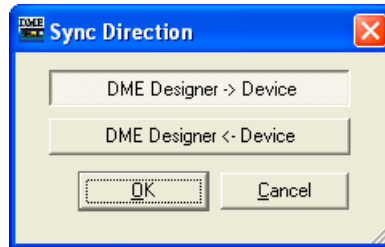

[DME Designer → Device] button

A consistency check is performed between the data in the current device group and the DME or SP2060 data, then the communication status changes to online. Transmits data from the DME Designer to the DME or SP2060 unit and synchronizes the two.

[DME Designer ← Device] button

Data from the DME or SP2060 unit is read into DME Designer. Current data stored in the DME or SP2060 unit, such as scenes, are read into DME Designer. The configurations in the DME unit and DME Manager must be identical to allow synchronization. If the configuration has been edited, synchronization can only be achieved by using the [DME Designer -> Device] button. SP2060 configurations cannot be edited, so synchronization is always possible.

NOTE

If the IP address of the DME device is changed after the device has been synchronized with DME Designer, it will be necessary to re-transfer the configuration data. The "Full Resync" operation forces a re-transfer of all configuration data, and can be initiated by clicking the [Go On-line] button while holding down the [Ctrl] key.

NOTE

For details on backing up the DME or SP2060 data as a file, refer to "Backup" on [page 183](#).

NOTE

Project files can also be saved internally in the DME unit using the DME File Storage function ([page 70](#)). Synchronization to DME or SP2060 units requires a project file. We recommend saving the project file to the DME unit itself to ensure that the file is always available.

■ [Go Off-line] Button

Clicking this button changes from online to offline. While offline, this button will be grayed out.

■ [Close] Button

Closes the dialog box.

■ [Close this window after synchronization] Checkbox

When this checkbox is checked the dialog window will close automatically after synchronization.

■ [Store Project File into DME after synchronization] Checkbox

When this checkbox is checked the project file (.daf extension) will be automatically saved in the DME unit after synchronization.

■ Designer

The Designer list displays DME or SP2060 units arranged in the currently valid device group in the DME Designer.

The unit in the DME Designer is matched with a recognized IP address, and they are compared one-to-one.

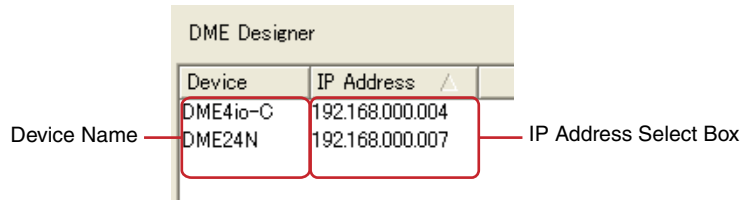

DME Name

Displays the names of DME or SP2060 units included in the project.

When multiple DMEs and SP2060s of the same type are arranged in a zone window, it is a good idea to change the name of each one.

IP Address Select Box

Matches the units in the Designer with recognized IP addresses. Click the [IP Address] column [V] button to see a list of the IP addresses of all devices of the same type in the area. If the unit is a DME24N, IP addresses for all DME24N devices in the area will be displayed on the list.

If you click the title bar with "IP Address" written on it (pale [▲]/[▼] mark appears), you can line them up vertically.

■ Network

The devices currently connected to the network are displayed in the Network list. To keep consistency with the Designer list on the left side, the status of DMEs on the network is displayed.

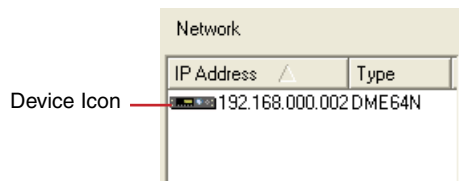

IP Address

- **Device Icon**

Displays DME, SP2060 and ICP1 devices connected to the network. The device group master DME or SP2060 icon is red. Icons for slave DMEs and SP2060s are blue. DMEs and SP2060s and ICP1 devices with no relation to DMEs and SP2060s in Designer have gray icons.

- **IP Address**

Displays the DME or SP2060 IP address.

■ Message Area

Displays a message that synchronization is in progress.

Event Scheduler

“Event Scheduler” Dialog Box

When you click [Event Scheduler] in the [Tools] menu, the “Event Scheduler” dialog box is displayed. This sets the scheduling for events. You can schedule events by specifying the date, time, and the action to execute. You can set up schedules for events to be executed at a specified time, and events that are to be repeated periodically. Periodic events are those that repeat each year, month, week, or day. Up to 50 events can be scheduled. Scheduling can be set separately for each device group. Settings and changes are sent to the DME unit during online status. Scene changes, parameter changes, GPI output, and Wave file playback can all be scheduled.

NOTE

Does not apply to SP2060 units

NOTE

Only users for whom the [Edit] checkbox in the “Security” dialog box has been turned ON can edit scheduling settings.

Names and Functions

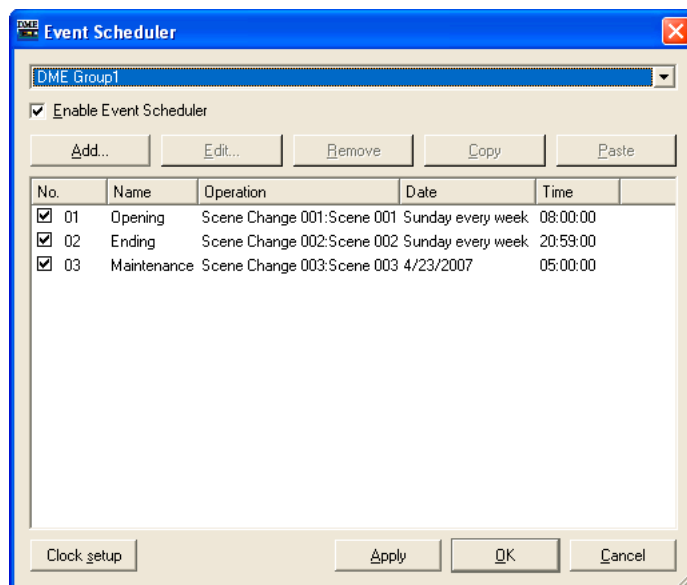

■ Event View

Displays registered scheduling events. When periodic events (cyclical events) are first displayed together, they are displayed in order of date.

The order of same-time events can be changed by dragging and dropping.

Click to select an event.

■ [No.]

Displays the event number. Numbers are added from the top in order.

This function will not be executed if the checkbox is not checked.

■ [Name]

Displays the event names. Clicking an event will select it, allowing you to change its name. There is no limit to the number of characters.

■ [Operation]

Displays the function that will be executed when the event starts.

■ [Date]

Displays the event start date.

Periodic events are displayed as shown below, with an icon and text that indicate a periodic event.

- **[January 1 every year]**
Each New Year's Day
- **[First Monday of January every year]**
First Monday in January each year
- **[Day 1 every month]**
First day of each month
- **[Second Monday of every month]**
The second Monday of each month.
- **[Monday every week]**
Each week on Monday
- **[Every day]**
Every day

■ [Time]

Displays the time for starting the event.

■ Group List

selects the device group for which events are to be specified/displayed. Only events for the selected device group will appear in the window.

■ [Enable Event Scheduler]

Enables the scheduled events.

■ [Add] Button

Adds an event. Clicking here displays the "Add Event" dialog box. If the maximum of 50 events has already been registered, this button is grayed out.

■ [Remove] Button

Deletes the event selected on the list. This button is grayed out when no event is selected.

■ [Edit] Button

Lets you edit the selected event. Displays the "Edit Event" dialog box. This button is grayed out when no event is selected.

■ [Copy] Button

Copies the selected event. This button is grayed out when no event is selected.

■ [Paste] Button

Pastes the copied event. The event is added. This button is grayed out when no event has been copied.

■ [Clock setup] Button

Opens the “Clock” dialog box to set the DME internal clock.
→ See “Clock” on [page 180](#).

■ [Apply] Button

Applies any current setting changes.

■ [OK] Button

Applies any setting changes and closes the window.

■ [Cancel] Button

Closes the window without changing any settings.

[Add Event (Edit Event)] Dialog Box

The dialog box is displayed when you click on the [Add] or [Edit] button in the “Event Scheduler” dialog box. Here you can add or edit a scheduling event.

The screenshot shows the "Add Event" dialog box with the following details:

- Title Bar:** DME Add Event
- Event Name:** Empty text input field.
- Event Operation:** Operation dropdown menu set to "Scene Change".
- Operation Setting:** Scene dropdown menu set to "001:Scene 001".
- Event Schedule:**
 - Calendar for October 2005. Today is 10/28/2005 (Friday).
 - Time field: 00:00:00 (hr:min:sec).
- Repeating Event:**
 - Repeating Event checkbox is unchecked.
 - Year, Month, Week, Day, and Hour radio buttons are present.
 - Day dropdown: January, 1.
 - Day of the week dropdown: January, First, Sunday.
 - Exception button.
- Buttons:** OK, Cancel.

■ [Event Name] Box

Enter the event name. There is no limit to the number of characters.

■ [Event Operation]

Set the operation that is executed when the event starts.

[Operation]

When you click this button, a list of events is displayed. Specify the operation that is executed when the event starts.

The following four items are on the list:

- [Scene Change]
Changes the scene.
- [Parameter Value Edit]
Changes a parameter.

NOTE

If user module security is enabled, the components are not displayed. However, parameters displayed in the user module editor are displayed here.

- [GPI Out]
Sends GPI output.
- [Play Wav File]
Allows initiation of Wave file playback.

[Operation Setting]

The content changes according to the event selected for [Operation].

- When [Scene Change] is selected:

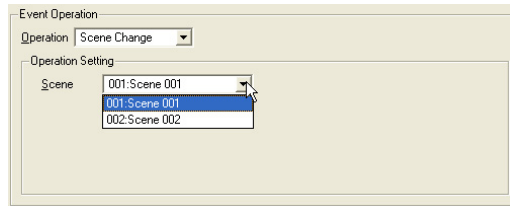

Select the scene to be recalled from the [Scene] list. Stored scenes are displayed in the list.

- When [Parameter Value Edit] is selected:

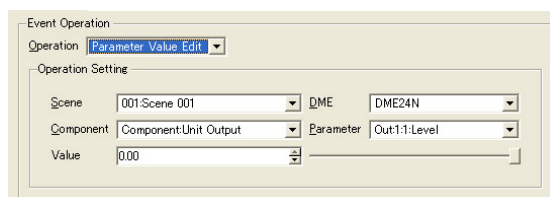

[Scene]

Select a scene from the list.

If the DME unit's current scene differs from the scene specified in event scheduling, the scheduled scene will be recalled. If the DME unit's current scene is the same as the scene specified in event scheduling, the scheduled scene will not be recalled.

[DME Unit]

From the list, select the DME unit to which this scheduled event will apply. The DMEs included in the zone are displayed in the list.

[Component]

Select the component that has the parameter to be changed. The list displays the components arranged for the DME that is selected in the [DME Unit] box.

[Parameter]

Select the parameter that will change. Parameters for the component that is selected in the [Component] box are displayed in a list.

[Value]

Set a value for the parameter. Change the parameter using the spin buttons or the slider on the right.

- When [GPI Out] is selected:

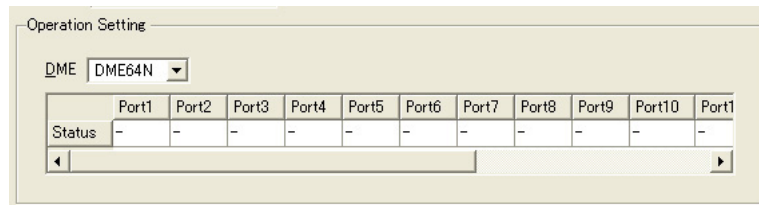
**[DME]**

From the list, select the DME where you will be making settings.

[Port1]/[Port2]/[Port3] ...

Set [ON], [OFF], or [---] for each port. If it is set to [OFF], the [LOW→HIGH] port outputs [HIGH→LOW] signal, the [HIGH→LOW] port outputs [LOW→HIGH] signal.

- When [Play Wav File] is selected:

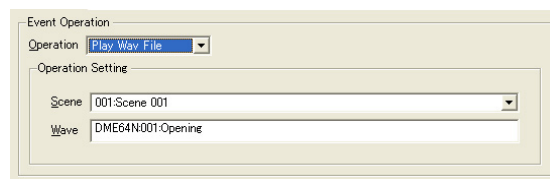
**[Scene]**

Select a scene from the list.

[Wave]

Select a Wave file from the list.

Wave files set by the Wav File manager can be specified. Files can not be selected unless a Wav File Player is included in the DME configuration.

■ [Event Schedule]

Set the year/month/date to start the event.

The screenshot shows the 'Event Schedule' dialog box. At the top, there is a calendar for 'October, 2005'. The 28th is selected with a red circle. Below the calendar, the 'Today' is shown as '10/28/2005'. To the right of the calendar is a 'Time' field with a spin box set to '00:00:00' and the label '(hr:min:sec)'. Below the time field is a 'Repeating Event' section with a checked checkbox. Underneath, there are radio buttons for 'Year', 'Month', 'Week', 'Day', and 'Hour'. To the right of these are dropdown menus for 'Day' (set to 'January') and 'Day of the week' (set to 'First' and 'Sunday'). An 'Exception' button is at the bottom right.

Calendar

Sets the date the event will start.

Change the year and month using the [<] and [>] buttons. Click on a day to set that date. February 29 can be set on the calendar, where it appears every four years (each leap year).

[Time]

Sets the time the event will start.

Click the hour and minute, then set numerical values using the spin boxes.

Only the time is set for periodic events.

[Repeating Event]

When a check is placed here, the event becomes a periodic event, and the calendar is ignored.

- [Year]/[Month]/[Week]/[Day]/[Hour]
Set the period for the event, using the radio buttons to the left.
- [Day]/[Day of the week]
Set the conditions on the right side. Select [Day]/[Day of the week], and set the date and other information. The items that can be set vary according to the selected period.

When the event period is [Year]

All settings can be made.

When the event period is [Month]

If [Day] is selected, only the date can be set.

If [Day of the Week] is selected, settings such as “the third Sunday” or “the first Monday” can be made.

When the event period is [Week]

Only [Day Of The Week] can be selected. Set the day of the week.

When the event period is [Day]/[Hour]

Condition settings on the area on the right are not needed.

[Exception] Button

Opens the “Event Exceptions” dialog box.

[OK] Button

Applies any setting changes and closes the window.

[Cancel] Button

Closes the window without changing any settings.

■ [Event Exceptions]

Specifies “exception” year/month/day and time settings at which events will not be executed.



The available settings will depend on the event cycle.

- **When the event cycle is [Year]**
Only the [Year] setting is available.
- **When the event cycle is [Month]**
Only the [Month] and [Week] setting is available.
- **When the event cycle is [Week]**
Only the [Month], [Week] and [Day] settings are available.
- **When the event cycle is [Day]**
Only the [Month], [Week], [Day], and [Day of the week] settings are available.
- **When the event cycle is [Hour]**
Only the [Month], [Week], [Day], [Day of the week], and [Hour] settings are available.

Wav File Manager

When you click [Wav File Manager] on the [Tools] menu, the “Wav File Manager” dialog box is displayed. Here you can manage playback settings for Wave files played in the Wav File Player. This is set for each DME. The setting can be made only when in offline status. Up to 100 Wave files can be managed.

If a Wave file is added that exceeds the memory limit, a warning message will be displayed.

NOTE

Does not apply to SP2060 units

NOTE

These settings can be edited only by users for whom the [Edit] checkbox in the “Security” dialog box has been turned ON.

NOTE

Only Wave files with file names of 31 characters or less, (including the extension) can be registered. Check the Wave file name beforehand. Change the name if it has 32 or more characters, including the extension.

NOTE

When saving project files including Wave files, select “Project File with wave (*.daf)” in the file save dialog box.

Names and Functions

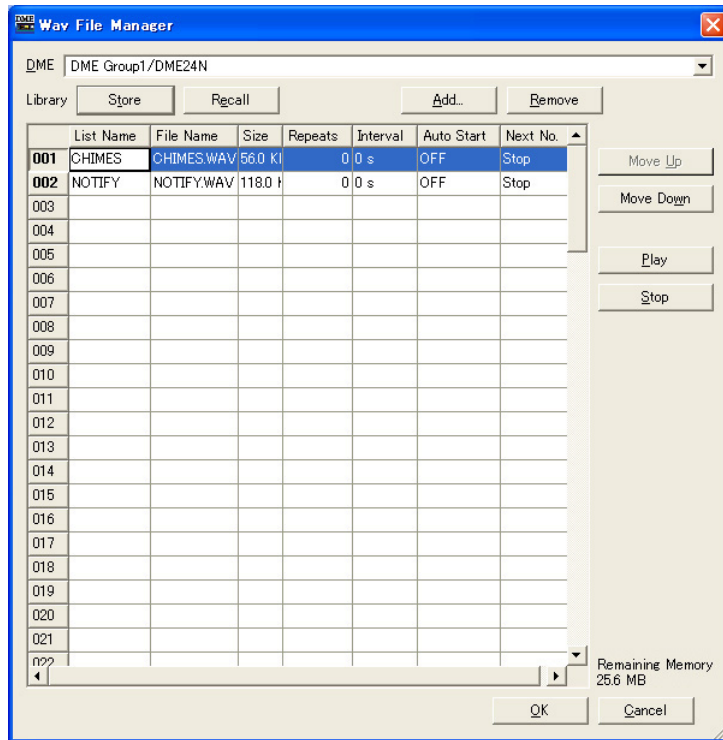

■ [DME]

From the list, select the DME where you will be making settings.

■ [Wave File]

Displays the Wave file information. Settings can be made here as well.

[No.]

The Wave file number is displayed in the leftmost column. Numbers are added from the top in order.

[List Name]

You can set up to 27 characters as a label separate from the Wave file name. The Wave file name is displayed here by default.

[File Name]

Up to 31 characters are displayed as the wave file name.

[Size]

Displays Wave file size information. The units vary, depending on the file size. The size is displayed to the first decimal.

Size	Display
Up to 1023 bytes	0.X KB
1024 bytes to 1023.9 kilobytes	XXX.X KB
1024 kilobytes or more	X.X MB

[Repeats]

Sets the number of repeats for playback.

Clicking here will display a list where you can select the number of times.

Select [0] to [98] or [INFINITY].

Since external input cannot be edited, [---] is displayed.

[Interval]

Sets the time until the next playback when [Repeats] is set to a value higher than 1. If you click here, a list will be displayed. You can set [0] to [99].

Since external input cannot be edited, [---] is displayed.

[Auto Start]

Turns automatic playback ON or OFF. When ON, playback begins automatically when the file is loaded.

If you click here, a list will be displayed. Select [ON] or [OFF].

[Next No.]

Specifies the number for the Wave file to be played next.

If you click here, a list will be displayed. Select the number for the Wave file to be played next.

- [Stop]

This stops playback after this Wave file is finished playing, without specifying the next wave file.

Since external input cannot be edited, [---] is displayed.

■ [Store] Button

Saves the current settings in the "Wav File Manager" dialog box in a file, as a library. Clicking here displays the file save dialog box.

■ **[Recall] Button**

Reads a saved library.

Clicking this button displays a menu. A menu displays library files saved in the folder that has been set as the Contents Folder. Click the library to be read.

[Open File Dialog]

Displays the file select dialog box. You can select a library file that is saved in the folder set as the Contents Folder, and read it.

■ **[Add] Button**

When you click here, External Input and the file select list is displayed.

To add a Wave file, select the row to which it is to be added and click the [Add] button.

It is also possible to add Wave files by dragging and dropping the files from the desktop directly onto the list in the “Wav File Manager” window.

[Wave File]

The file selection dialog box is displayed, where you can select a Wave file.

If the selected table already has data, an overwrite confirmation message is displayed.

[External Input]

Sets [External Input].

You can select multiple Wave files. If multiple files are specified, they are added after the selected table. If a Wave file is registered to the number being added, it will be overwritten.

The following Wave file formats are supported: 48, 44.1, 24, 22.05 kHz, 16bit/8bit, Mono/Stereo. If a file is selected with a format different than these, a message is displayed that says the file cannot be used.

There is an upper limit to size beyond which a file cannot be used. This limit varies according to the format. If the size of the selected file is beyond the limit, a message is displayed that says the file cannot be used.

Maximum Size Per File and Playback Time

			DME64N/24N (Memory Limit: 25.8M)		DME Satellite (Memory Limit: 11.8M)	
22.05 kHz	8bit	Mono	3.6 Mbyte	174 sec	1.3 Mbyte	65 sec
		Stereo	7.3 Mbyte	174 sec	2.7 Mbyte	65 sec
	16bit	Mono	7.3 Mbyte	174 sec	2.7 Mbyte	65 sec
		Stereo	14.7 Mbyte	174 sec	5.5 Mbyte	65 sec
24 kHz	8bit	Mono	4.0 Mbyte	174 sec	1.5 Mbyte	65 sec
		Stereo	8.0 Mbyte	174 sec	3.0 Mbyte	65 sec
	16bit	Mono	8.0 Mbyte	174 sec	3.0 Mbyte	65 sec
		Stereo	16.0 Mbyte	174 sec	6.0 Mbyte	65 sec
44.1 kHz	8bit	Mono	7.3 Mbyte	174 sec	2.7 Mbyte	65 sec
		Stereo	14.7 Mbyte	174 sec	5.5 Mbyte	65 sec
	16bit	Mono	14.7 Mbyte	174 sec	5.5 Mbyte	65 sec
		Stereo	25.8 Mbyte	153 sec	11.0 Mbyte	65 sec
48 kHz	8bit	Mono	8.0 Mbyte	174 sec	3.0 Mbyte	65 sec
		Stereo	16.0 Mbyte	174 sec	6.0 Mbyte	65 sec
	16bit	Mono	16.0 Mbyte	174 sec	6.0 Mbyte	65 sec
		Stereo	25.8 Mbyte	140 sec	11.8 Mbyte	64 sec

NOTE

The values in the above chart are all approximate. Playback time will also vary according to the Wave file format.

NOTE

When a Wave file is played back while the DME is set to operate at 88.2 kHz or 96 kHz, only the OUT1 output of the Wav File Player will be delivered via the Left channel. There will be no output from OUT2.

■ [Remove] Button

Deletes settings from the selected line. This button is grayed out when no Wave file is selected in the list.

■ [Move Up] Button

Moves the selected line up one. It is switched with the line immediately above.
The button will be grayed out if nothing is selected in the list, or if [No. 1] is selected in the list.

■ [Move Down] Button

Moves the selected line down one. It is switched with the line immediately below.
The button will be grayed out if nothing is selected in the list, or if [No. 100] is selected in the list.

■ [Play] Button

Plays the selected Wave file on the computer. Allows monitoring and checking of the Wave file.

■ [Stop] Button

Stops playback of the Wave file.

■ [Remaining Memory]

Displays the amount of available Wave file memory.

■ [OK] Button

Updates the settings and closes the dialog box.

■ [Cancel] Button

Closes the dialog box without changing the settings.

GPI

About GPI

GPI is an abbreviation for General Purpose Interface. Using GPI input and output, DMEs can be remotely controlled from custom-made controllers or external equipment. The number of GPI ports depends on the type of device. Sets GPI input/output for each DME.

Using GPI input data, you can switch DME scenes and change component change component parameters.

Refer to the DME owner’s manual for information on making GPI connections and other hardware-related issues.

NOTE
Only users for whom the [Operation Security] → [Edit] checkbox has been checked can make GPI settings.



NOTE
This cannot be set when online.

NOTE
Does not apply to SP2060 units









GPI Input/Output Setup Example







■ Control Faders (Levels and On) via a CP4SF

A CP4SF control panel connected to the GPI terminal can be used to control the faders (Level and On parameters) of Fader and Mixer components.

By assigning the component's Level and On parameters via the Parameter Value Edit function in the GPI IN field it becomes possible to use the CP4SF faders and switches to control the assigned Level and On parameters. If the port assigned to the Level parameter is set to [Min]=-INFINITYdB, [Max]=10.00dB, [Terminal]= , the parameter will be controlled in proportion to the input voltage (= fader position). The minimum input voltage will produce a level setting of -∞dB, and the maximum input voltage will produce a level setting of 10.00dB. If the port assigned to the On parameter is set to [Min]=OFF, [Max]=ON, [Terminal]= , the parameter will toggle between ON and OFF each time the input voltage goes from low to high (= the moment that the switch is pressed).

By assigning the component's On parameter via the Parameter Value Edit function in the GPI OUT field, the CP4SF switch LED can be toggled by the ON parameter. If [Terminal] is set to , a high level will be output when the On parameter is on, lighting the LED.

GPI IN						
Port	Function	Parameter	Min	Max	Terminal	
Port1	Parameter Value Edit	Component:Fader:Fader:1:1:Level	-INFINITYdB	10.00dB		
Port2	Parameter Value Edit	Component:Fader:Fader:2:1:Level	-INFINITYdB	10.00dB		
Port3	Parameter Value Edit	Component:Fader:Fader:3:1:Level	-INFINITYdB	10.00dB		
Port4	Parameter Value Edit	Component:Fader:Fader:4:1:Level	-INFINITYdB	10.00dB		
Port5	Parameter Value Edit	Component:Fader:Fader:1:1:On	OFF	ON		
Port6	Parameter Value Edit	Component:Fader:Fader:2:1:On	OFF	ON		
Port7	Parameter Value Edit	Component:Fader:Fader:3:1:On	OFF	ON		
Port8	Parameter Value Edit	Component:Fader:Fader:4:1:On	OFF	ON		





GPI OUT						
Port	Function	Parameter	Threshold	Terminal	Polarity	Event S
Port1	Parameter Value Edit	Component:Fader:Fader:1:1:On	0.5			
Port2	Parameter Value Edit	Component:Fader:Fader:2:1:On	0.5			
Port3	Parameter Value Edit	Component:Fader:Fader:3:1:On	0.5			
Port4	Parameter Value Edit	Component:Fader:Fader:4:1:On	0.5			
Port5	No Assign					
Port6	No Assign					
Port7	No Assign					







■ Control Source Selection via a CP4SW

A CP4SW control panel connected to the GPI terminal can be used to switch the channel source of Source Selector (Position 4) components.

Assign the Source Selector component's Position parameter via the Parameter Value Edit function in the GPI IN and GPI OUT fields and set the parameter values ([Max] in the GPI IN field, and [Threshold] in the GPI OUT field) to 1 through 4 for the corresponding ports. The CP4SW switches will then select the corresponding channel sources, and the corresponding switch LED will light.

[Terminal] in the GPI IN field cannot be altered. If [Terminal] in the GPI OUT field is set to , a high level voltage will be output and the LED will light when the Position parameter matches the [Threshold] setting.

GPI IN					
Port	Function	Parameter	Min	Max	Terminal
Port1	Direct Parameter Value	Component:Source Selector:Position:1:1:Position	---	---	1 
Port2	Direct Parameter Value	Component:Source Selector:Position:1:1:Position	---	---	2 
Port3	Direct Parameter Value	Component:Source Selector:Position:1:1:Position	---	---	3 
Port4	Direct Parameter Value	Component:Source Selector:Position:1:1:Position	---	---	4 
Port5	No Assign				
Port6	No Assign				
Port7	No Assign				
Port8	No Assign				

GPI OUT					
Port	Function	Parameter	Threshold	Terminal	F
Port1	Direct Parameter Value	Component:Source Selector:Position:1:1:Position	1 		
Port2	Direct Parameter Value	Component:Source Selector:Position:1:1:Position	2 		
Port3	Direct Parameter Value	Component:Source Selector:Position:1:1:Position	3 		
Port4	Direct Parameter Value	Component:Source Selector:Position:1:1:Position	4 		
Port5	No Assign				
Port6	No Assign				
Port7	No Assign				

“GPI” Dialog Box

When you click the [GPI] command on the [Tools] menu, the “GPI” dialog box is displayed. Sets GPI input/output for the DME.

Names and Functions

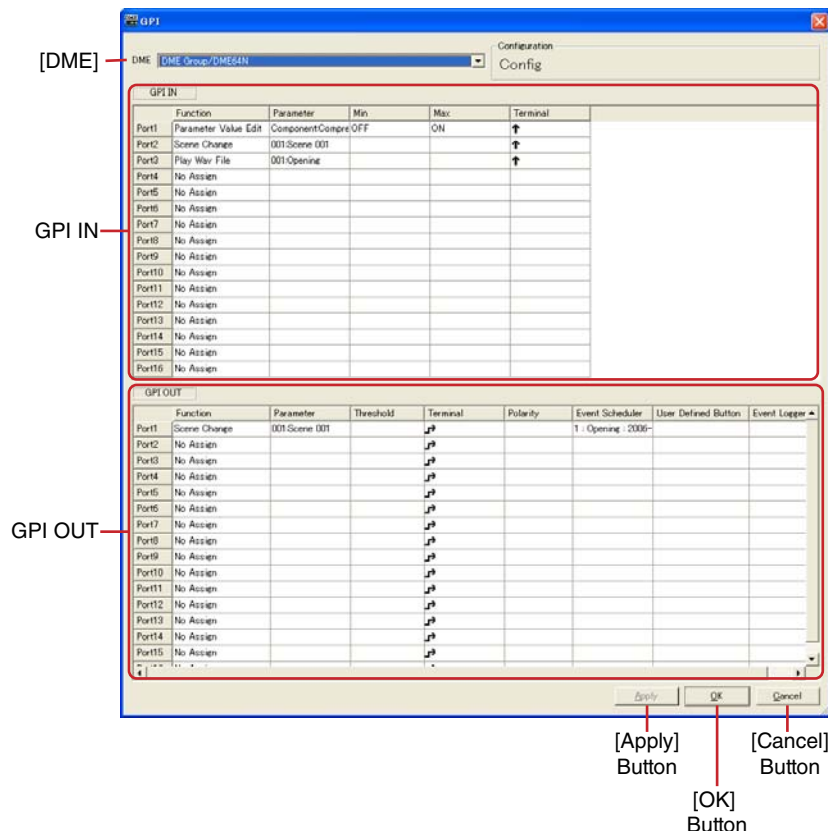

■ [DME]

From the list, select the DME where you will be making settings.

■ Configuration

The current configuration name will be displayed.

■ GPI IN

The DME64N has 16 GPI IN channels, and the DME24N/DME Satellite has 8 GPI IN ports. These settings determine which DME parameters will be controlled by input received at each individual GPI IN port. The port numbers are shown in the leftmost column.

[Function]

Specifies the function to be controlled by GPI input. Click to see a list from which you can choose the function to be assigned to the corresponding GPI IN port.

The ten available functions are: [No Assign], [Parameter Value Edit], [Direct Parameter Value], [Scene Change], [Scene Increment], [Scene Decrement], [Mute], [GPI Lock], [Time Adjustment], [Play Wav File].

The [Parameter], [Min], [Max], and [Terminal] items will change according to the selected function.

GPI IN					
	Function	Parameter	Min	Max	Terminal
Port1	Parameter Value Edit	Component:Delay-Lc	-INFINITYdB	0.00dB	↑
Port2	Direct Parameter Value	Component:Delay-Lc...		0.00dB	↔
Port3	Scene Change	001:Scene 001			↑
Port4	No Assign				↑
Port5	Parameter Value Edit				↑
Port6	Direct Parameter Value				↑
Port7	Scene Change				↑
Port7	Scene Increment				↑
Port8	Scene Decrement				↑
Port9	Mute				↑
Port10	GPI Lock				
Port11	Time Adjustment				
Port11	Play Wav File				
Port12	No Assign				

- [No Assign]

No function assigned. This is the default setting.

Select [No Assign] to clear an assigned function.

The [Parameter], [Min], [Max], and [Terminal] items are not available.

- [Parameter Value Edit]

Allows component parameters to be changed via GPI input.

In this case [Parameter] is used to select the parameter to be controlled.

[Min] and [Max] specify the range over which the parameter can be changed.

[Terminal] determines how the GPI input voltage will affect the specified parameter.

NOTE

Components for user modules are also listed in a hierarchal display, but if user module security is enabled, the components are not displayed. However, parameters displayed in the user module editor are displayed here.

↑ and ↓ specify continuous control of continuously-variable parameters from an external fader, knob, or similar device.

↔ and ↵ specify on/off control of 2-state parameters via an external switching device.



The parameter value changes in proportion to the voltage applied to the GPI input. The minimum voltage applied to GPI IN will produce the specified [Min] parameter value, and the maximum voltage applied to GPI IN will produce the specified [Max] parameter value, with intermediate voltages produced the corresponding intermediate parameter values.

Example: Relationship between the voltage applied to GPI IN and the Fader Level when [Fader Level] is set in the [Parameter] box.

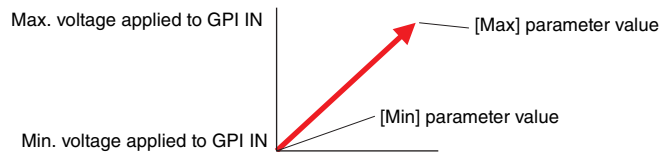

The parameter value changes in inverse proportion to the voltage applied to the GPI input. The minimum voltage applied to GPI IN will produce the specified [Max] parameter value, and the maximum voltage applied to GPI IN will produce the specified [Min] parameter value, with intermediate voltages produced the corresponding intermediate parameter values.

Example: Relationship between the voltage applied to GPI IN and the Fader Level when [Fader Level] is set in the [Parameter] box.

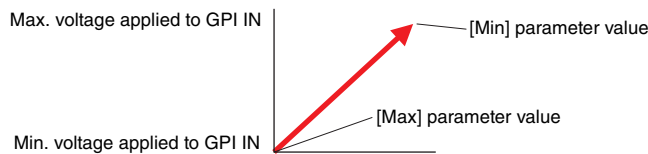

The specified [Min] and [Max] parameter values are alternately selected each time the voltage applied to GPI IN rises from below to above the median voltage.*

Example: Relationship between the voltage applied to GPI IN and the Fader Level when [Fader Level] is set in the [Parameter] box.

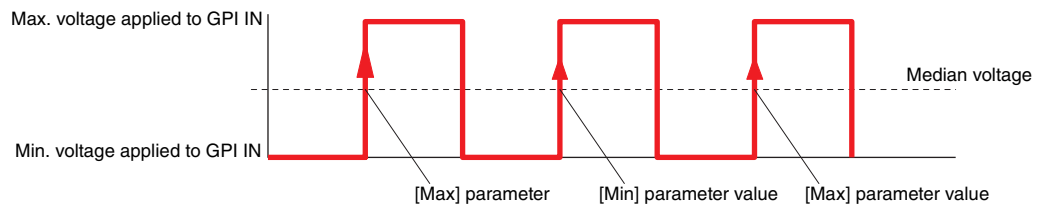

The specified [Min] and [Max] parameter values are alternately selected each time the voltage applied to GPI IN drops from above to below the median voltage.*

Example: Relationship between the voltage applied to GPI IN and the Fader Level when [Fader Level] is set in the [Parameter] box.

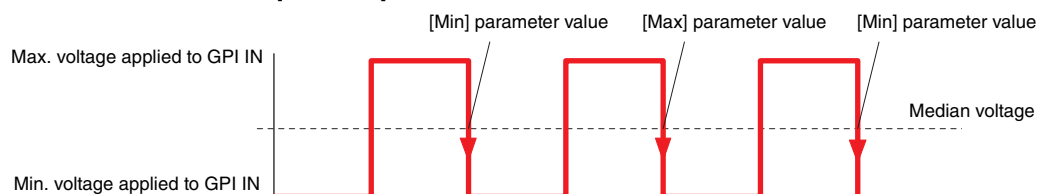

- **[Direct Parameter Value]**

Sets component parameters to a specified value. Select the parameter to be set via [Parameter], and [Max] sets the parameter value. [Min] and [Terminal] are unavailable. When the voltage at the GPI input changes from below to above the median voltage, the parameter is set to the value specified by [Max].

- **[Scene Change]**

GPI input can be used to recall a specified scene.

[Parameter] specifies the number of the scene to be recalled.

[Min] and [Max] are not available.

[Terminal] determines how the GPI input voltage will affect the specified parameter.



The scene specified by [Parameter] will be recalled each time the voltage applied to GPI IN rises from below to above the median voltage.*

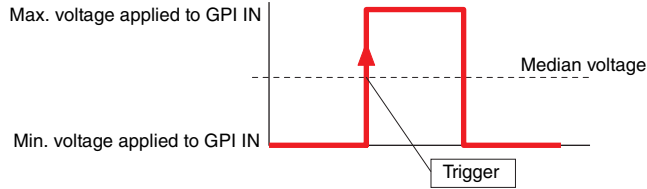

The scene specified by [Parameter] will be recalled each time the voltage applied to GPI IN drops from above to below the median voltage.*

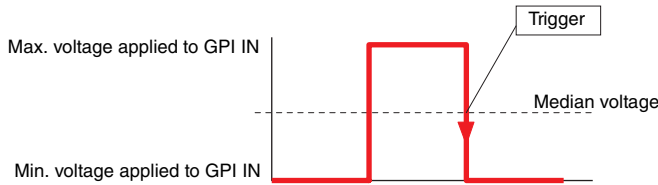

Same as ↑.



Same as ↓.

- **[Scene Increment]**

GPI input can be used to increment the scene number.

[Parameter], [Min], and [Max] are not available.

[Terminal] determines how the GPI input voltage will affect the specified parameter.



The scene number will be incremented each time the voltage applied to GPI IN rises from below to above the median voltage.*

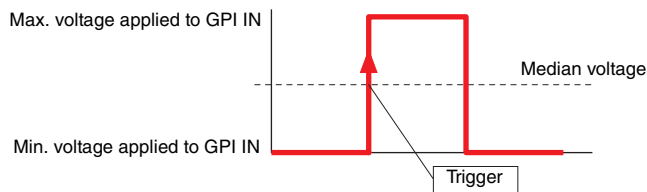

The scene number will be incremented each time the voltage applied to GPI IN drops from above to below the median voltage.*

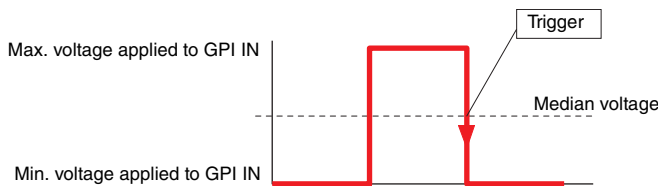

Same as ↑.



Same as ↓.

- [Scene Decrement]

GPI input can be used to decrement the scene number.

[Parameter], [Min], and [Max] are not available.

[Terminal] determines how the GPI input voltage will affect the specified parameter.



The scene number will be decremented each time the voltage applied to GPI IN rises from below to above the median voltage.*

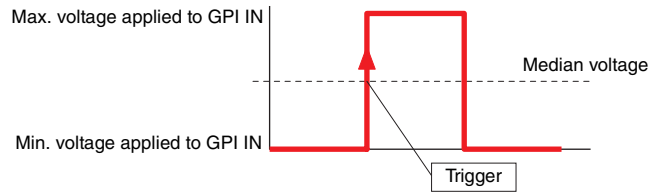

The scene number will be decremented each time the voltage applied to GPI IN drops from above to below the median voltage.*

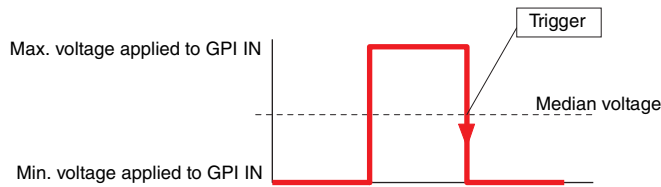

Same as ↑.



Same as ↓.

- [Mute]

GPI input can be used to engage or disengage the DME mute function.

[Parameter], [Min], and [Max] are not available.

[Terminal] determines how the GPI input voltage will affect the specified parameter.



Mute will be ON when the voltage applied to GPI IN is above the median voltage*, and OFF when the voltage is below the median.

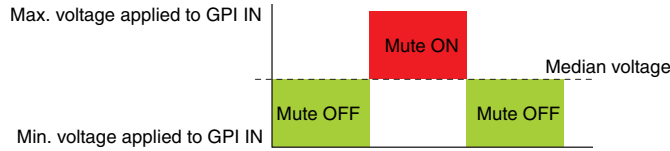

Mute will be OFF when the voltage applied to GPI IN is above the median voltage*, and ON when the voltage is below the median.

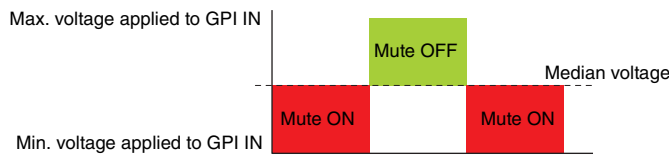

Mute will be alternately turned ON and OFF each time the voltage applied to GPI IN drops from below to above the median voltage.*

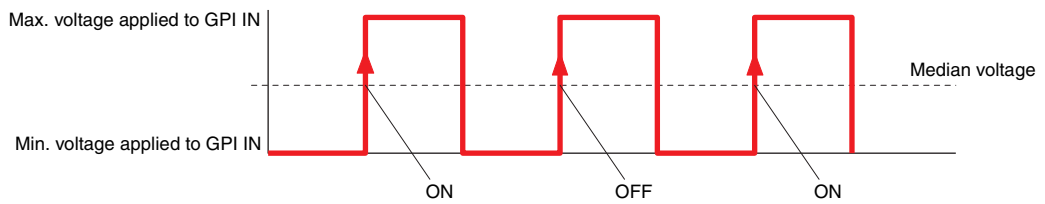

Mute will be alternately turned ON and OFF each time the voltage applied to GPI IN rises from above to below the median voltage.*

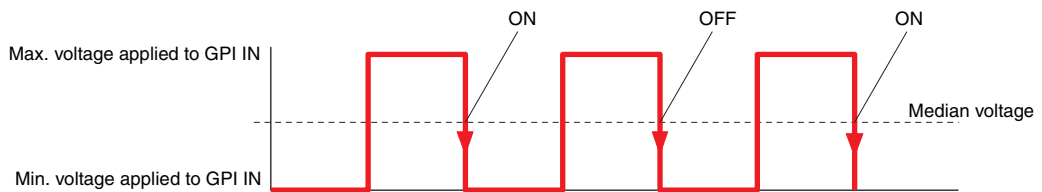

- [GPI Lock]

GPI Lock can be turned on or off via GPI input. When GPI Lock is ON, all GPI inputs other than the one being used for GPI Lock control are locked and input will be ignored.

[Parameter], [Min], and [Max] are not available.

[Terminal] determines how the GPI input voltage will affect the specified parameter.



GPI lock will be ON when the voltage applied to GPI IN is above the median voltage*, and OFF when the voltage is below the median.

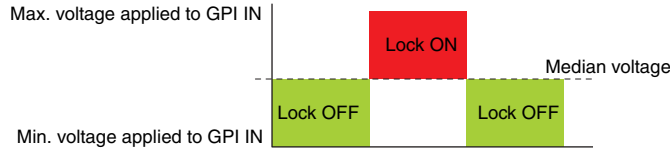

GPI Lock will be OFF when the voltage applied to GPI IN is above the median voltage*, and ON when the voltage is below the median.

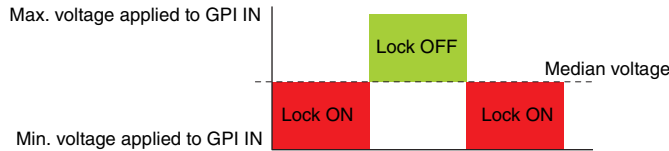

GPI Lock will be alternately turned ON and OFF each time the voltage applied to GPI IN drops from below to above the median voltage.*

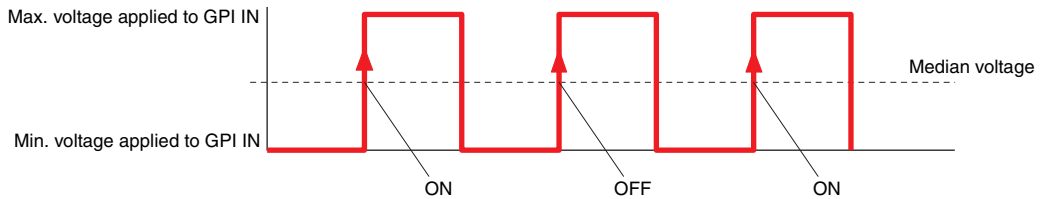

GPI Lock will be alternately turned ON and OFF each time the voltage applied to GPI IN rises from above to below the median voltage.*

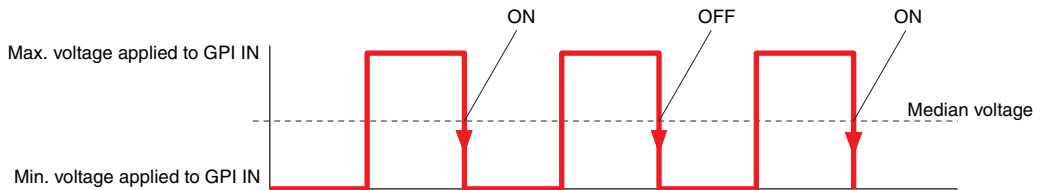

• [Time Adjustment]

GPI input can be used to adjust the DME internal clock as follows:

Internal clock time	Time after adjustment
0~14 seconds	Returned to 0 seconds
15~29 seconds	Advanced to 30 seconds
30~44 seconds	Returned to 30 seconds
45~59 seconds	Advanced to 0 seconds

[Parameter], [Min], and [Max] are not available.

[Terminal] determines how the GPI input voltage will affect the specified parameter.

⬆ and ⬇ specify continuous control of continuously-variable parameters from an external fader, knob, or similar device.

⬆ and ⬇ specify on/off control of 2-state parameters via an external switching device.



The internal clock time will be adjusted each time the voltage applied to GPI IN rises from below to above the median voltage.*

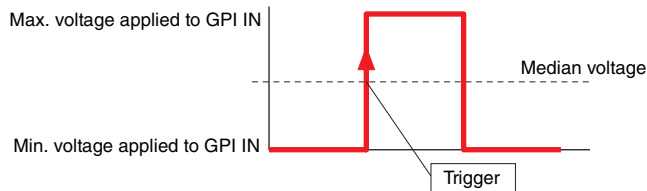

The internal clock time will be adjusted each time the voltage applied to GPI IN drops from above to below the median voltage.*

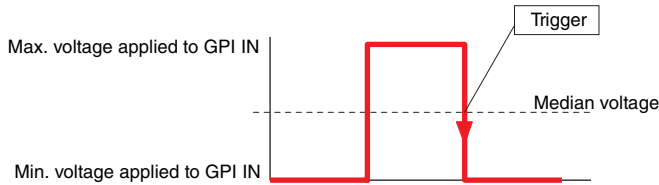

Same as ⬆.



Same as ⬇.

- [Play Wav File]

GPI input can be used to initiate playback of the specified Wave file.

[Parameter] specifies the Wave file to be played. Files specified by the Wav File Manager can be selected. Wave files can only be selected if a Wav File Player is included in the DME configuration.

[Min], and [Max] are not available.

[Terminal] determines how the GPI input voltage will affect the specified parameter.

↑ and ↓ specify continuous control of continuously-variable parameters from an external fader, knob, or similar device.

↔ and ↵ specify on/off control of 2-state parameters via an external switching device.



The specified Wave file will be played each time the voltage applied to GPI IN rises from below to above the median voltage.*

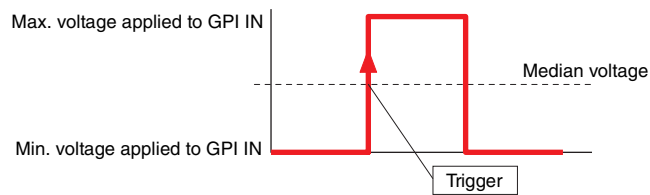

The specified Wave file will be played each time the voltage applied to GPI IN drops from above to below the median voltage.*

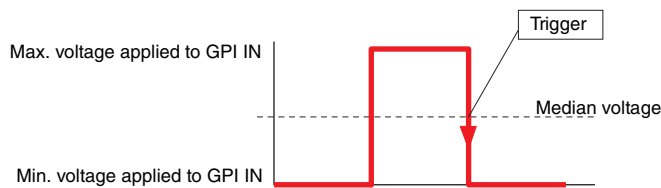

Same as ↑.



Same as ↓.

* "Median voltage" refers to the voltage halfway between the maximum and minimum voltages detectable by the GPI input terminals. Refer to the DME owner's manual for details on GPI voltages.

■ GPI OUT

The DME64N has sixteen GPI OUT ports, the DME24N has eight, and the DME Satellite has four. These settings determine which DME parameter values will be output via each individual GPI IN ports. The ports numbers are shown in the leftmost column.

[Function]

Specifies the function to be transmitted via a GPI output.

The six available functions are: [No Assign], [Parameter Value Edit], [Scene Change], [GPI Lock], [Direct Parameter Value], and [Audio Detector].

The [Parameter], [Threshold], [Terminal], and [Polarity] items will change according to the selected function.

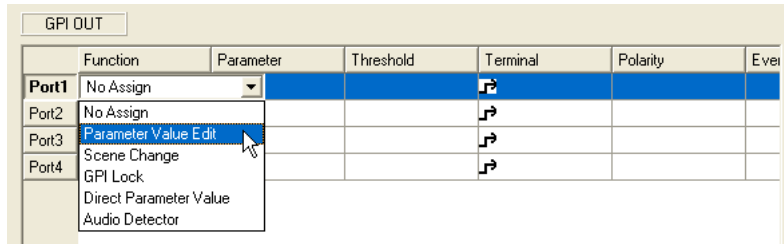

- **[No Assign]**
No function assigned, and no GPI output will occur. This is the default setting. Select [No Assign] to clear an assigned function. The [Parameter], [Threshold], [Terminal], and [Polarity] items are not available.
- **[Parameter Value Edit]**
Allows component parameter values to be output via GPI. [Parameter] selects the parameter to be output via the GPI OUT terminals. [Threshold] specifies the parameter threshold value. [Terminal] and [Polarity] determine how the GPI voltage will be output in response to parameter changes.

Terminal	Polarity	GPI Output
	Ignored	When value of the specified parameter is above the threshold level the output will be high, and when below the threshold level the output will be low.
	Ignored	When value of the specified parameter is below the threshold level the output will be high, and when above the threshold level the output will be low.
	↑	A pulse ^{*1} will be output when the value of the parameter changes from below to above the threshold.
	↓	A pulse ^{*1} will be output when the value of the parameter changes from above to below the threshold.
	↑	A pulse ^{*2} will be output when the value of the parameter changes from below to above the threshold.
	↓	A pulse ^{*2} will be output when the value of the parameter changes from above to below the threshold.





- **[Scene Change]**

The recall status of the specified scene is transmitted via GPI output.

[Parameter] specifies the scene for which the recall status is to be output.

[Threshold] and [Polarity] are not available.

[Terminal] determines how the GPI voltage will be output in response to parameter changes.



Terminal	GPI Output
	When the current scene is the same as the scene specified by [Parameter] the output will be high, and when different the output will be low.
	When the current scene is the same as the scene specified by [Parameter] the output will be low, and when different the output will be high.
	A pulse ^{*1} will be output when the current scene is the same as the scene specified by [Parameter].
	A pulse ^{*2} will be output when the current scene is the same as the scene specified by [Parameter].

- **[GPI Lock]**

The GPI Lock status is transmitted via GPI output.

[Parameter], [Threshold], and [Polarity] are not available.

[Terminal] determines how the GPI voltage will be output in response to parameter changes.





Terminal	GPI Output
	When GPI Lock is ON the output will be high, and when OFF the output will be low.
	When GPI Lock is ON the output will be high, and when OFF the output will be low.

- **[Direct Parameter Value]**

GPI output is produced when a component parameter reaches a specified value. [Parameter]

sets the parameter name. [Threshold] sets the parameter value. [Polarity] is unavailable.

[Terminal] specifies the type of GPI output produced.





Terminal	GPI Output
	A high level is output when the value specified by [Parameter] is equal to [Threshold].
	A low level is output when the value specified by [Parameter] is equal to [Threshold].
	Pulse waveform 1 (*1) is output at the instant the value specified by [Parameter] becomes equal to [Threshold].
	Pulse waveform 2 (*2) is output at the instant the value specified by [Parameter] becomes equal to [Threshold].

- **[Audio Detector]**

The audio signal status detected by the Audio Detector component is output via GPI OUT.

[Parameter] selects the Audio Detector component that will produce GPI output according to the detected audio signal status. [Terminal] and [Polarity] specify the type of GPI output

produced.

Terminal	Polarity	GPI Output
	Ignored	High level while an audio signal is detected, low level while no audio signal is detected.
	Ignored	High level while no audio signal is detected, low level while an audio signal is detected.
		Pulse waveform 1 (*1) is output when the status changes from no audio signal detected to audio signal detected.
		Pulse waveform 1 (*1) is output when the status changes from audio signal detected to no audio signal detected.

Terminal	Polarity	GPI Output
T ⁺	↑	Pulse waveform 2 (*2) is output when the status changes from no audio signal detected to audio signal detected.
	↓	Pulse waveform 2 (*2) is output when the status changes from audio signal detected to no audio signal detected.

*1 Pulse waveform 1

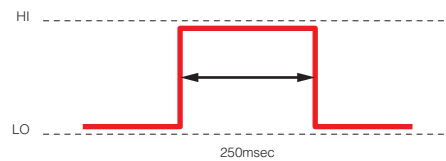

*2 Pulse waveform 2

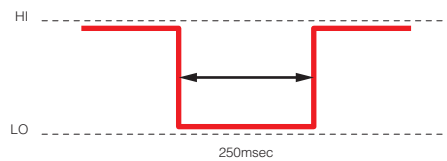

Event Scheduler

Event Schedule is shown when [GPI OUT] is set in "Event Scheduler."

See "Event Scheduler" on [page 101](#).

User Defined Button

User Defined Button is shown when [GPI OUT] is set in "User Defined Button."

See "User Defined Button (User Defined Parameters)" on [page 132](#).

Event Logger

Event Log is shown when [GPI OUT] is set in "Event Logger."

See "Event Logger" on [page 75](#).

[Apply] Button

Applies any current setting changes.

[OK] Button

Applies any setting changes and closes the window.

[Cancel] Button

Closes the window without changing any settings.

MIDI

When you click the [MIDI] command on the [Tools] menu, the “MIDI” dialog box is displayed. Here you can make remote control and other settings.

NOTE

Does not apply to SP2060 units

Names and Functions

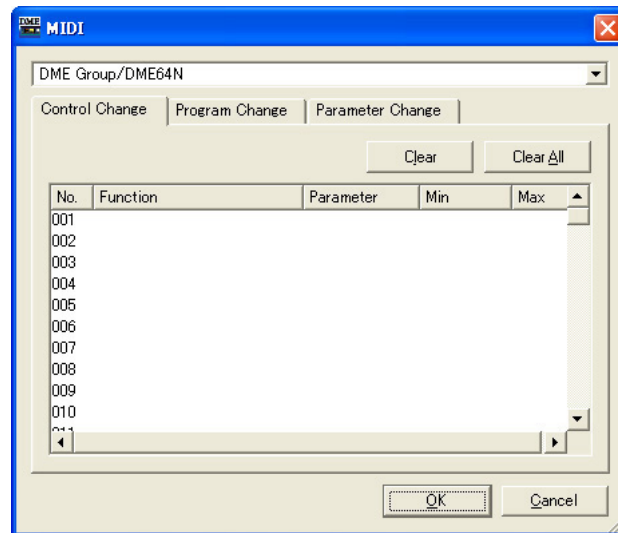

■ Common to All Tabs

DME

From the list, select the DME where you will be making settings.

[OK] Button

Applies any setting changes and closes the window.

[Cancel] Button

Closes the window without changing any settings.

[Control Change] Tab

Assigns components to control change for each DME. You can change DME parameters by sending control change messages from external equipment. You can assign to control change numbers 1-31, 33-95, and 102-119.

NOTE

Because control change numbers 0 and 32 are used for bank select MSB, numbers 96-101 are RPN/NRPN related, and 120-127 are used for mode messages, they cannot be used for component assignment.

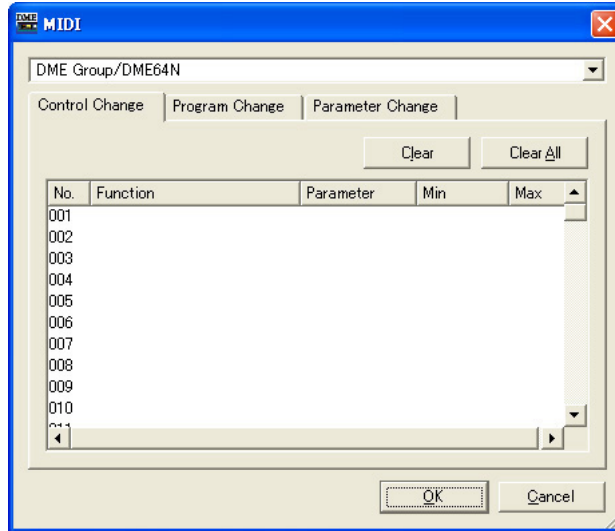

■ Control Change List

The control change numbers and current settings are displayed in the list in the center.

No.

Displays the control change numbers.

Component

Displays the assigned components. Control changes that have no component assigned to them are blank. If you click here, a list will be displayed. Usable components are on the list. Click the component name to select it.

NOTE

If user module security is enabled, the components are not displayed. However, parameters displayed in the user module editor are displayed here.

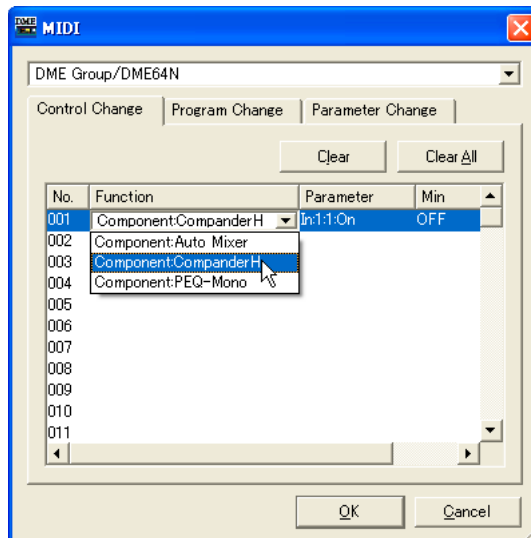

Parameter

Set the assigned component link parameter.

When you click here, a list of parameters included in the component is displayed. Select the parameter you want to assign.

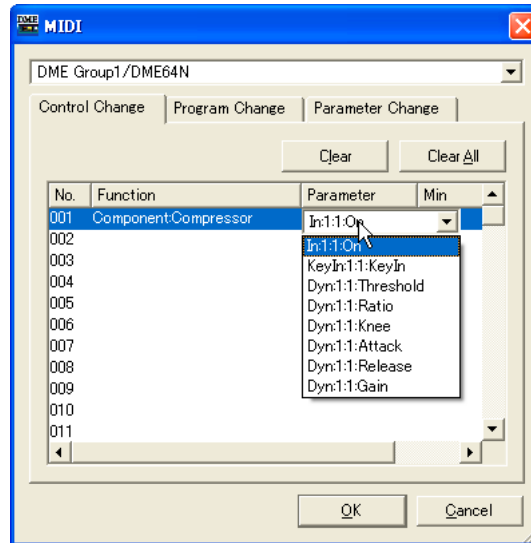

Min/Max

Sets the range of operation for the parameter. The current values for the [Min] (lower limit) and [Max] (upper limit) are displayed. If you click here, a slider will be displayed. The range and parameter units that can be set will vary, depending on the parameter selected in the [Parameter] box.

You can change the parameter by dragging the slider. To make a finer setting, press the <Shift> key while dragging the slider. The value for the parameter will be shown while you are dragging the slider. When you finish dragging and release the mouse button, the slider will disappear.

The same slider is displayed whether you click the [Min] box or the [Max] box. The black part is the parameter range. If you drag the left edge of the black part, the [Min] value will change. If you drag the right edge, the [Max] will change.

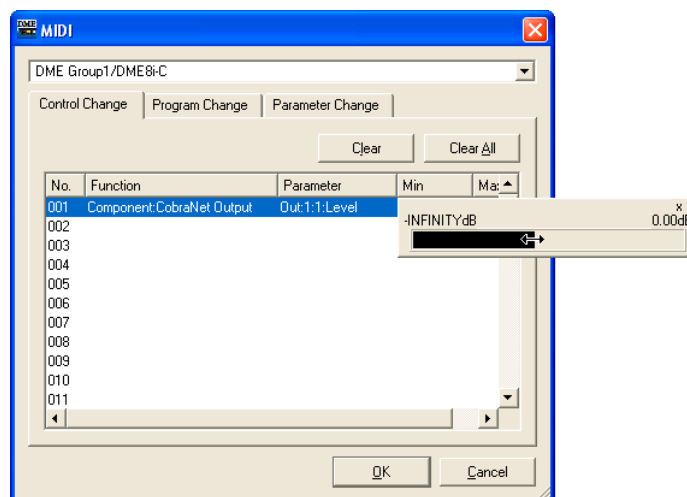

■ [Clear] Button

Clears assignments for the selected control change numbers.

■ [Clear All] Button

Clears assignments for all control change numbers.

[Program Change] Tab

Assigns scenes to program control change numbers 1 through 128. Switches scenes when program changes are received. These settings are shared by all DMEs in the device group. Up to 999 assignments can be made. Scenes above number 128 are assigned by changing banks.

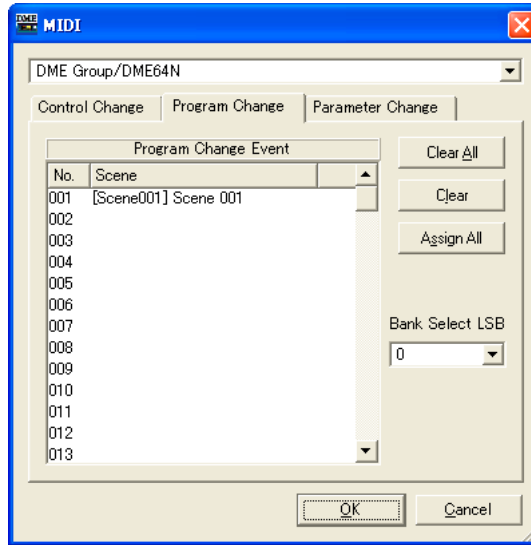

■ Program Change Event

Program numbers and the scenes assigned to them are displayed in a list.

No.

This displays program numbers from 1 to 128.

Scene

Displays the scene number and name of the assigned scene. Program changes that have no scene assigned to them are blank.

When you click here, a list of scenes is displayed. Select the scene you want to assign.

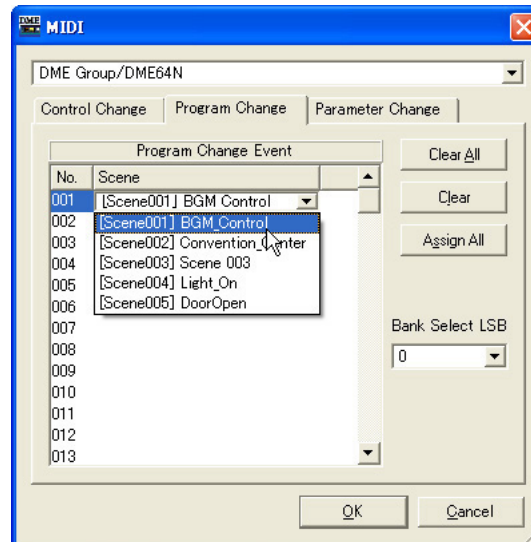

■ [Clear All] Button

Clears all scene assignments.

■ [Clear] Button

Clears the scene assignment for the program number selected in the list, so that no scene is assigned to that number.

■ [Assign All] Button

Assigns all scenes in order starting from program number 1.

■ Bank Select LSB

The bank is changed when assigning scenes numbered 129 and higher. Eight banks can be used, numbered from zero to seven. Click the [▼] and select the bank where you will make settings.

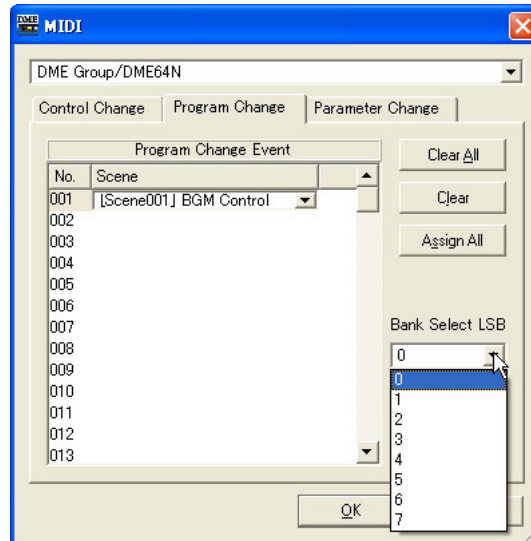

[Parameter Change] Tab

Specifies the parameter to be controlled by parameter change commands for each address. Up to 128 can be set.

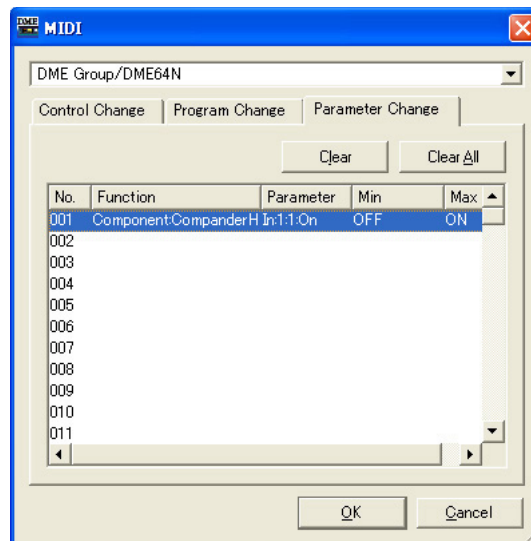

■ Parameter Change List

The current settings are displayed in the list in the center.

No.

This displays the parameter change numbers.

Component

Assigns components. If you click here, a list will be displayed. Assignable components are on the list. Click the component name to select it.

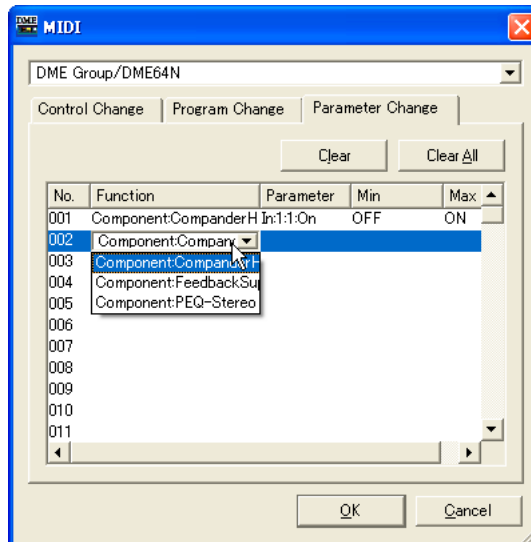

Parameter

Set the assigned component link parameter.

When you click here, a list is displayed of parameters included in the component selected in the [Component] box.

Select the parameter you want to assign.

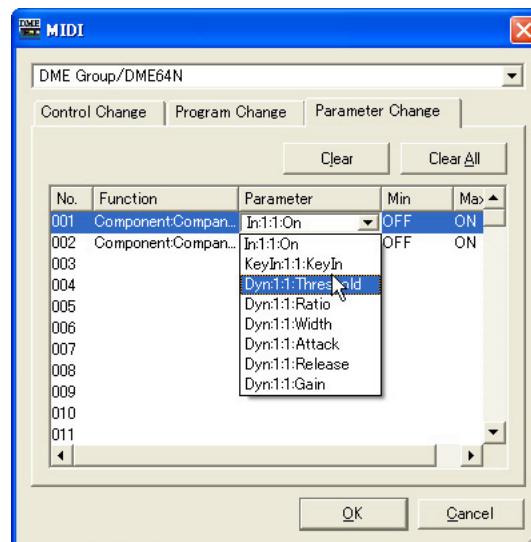

Min/Max

This sets the parameter range. The current values for the [Min] (lower limit) and [Max] (upper limit) are displayed. The range and units that can be set will vary, depending on the parameter selected. If you click here, a slider will be displayed.

You can change the parameter by dragging the slider. To make a finer setting, press the <Shift> key while dragging the slider. The value for the parameter will be shown while you are dragging the slider. When you finish dragging and release the mouse button, the slider will disappear.

The same slider is displayed whether you click the [Min] box or the [Max] box. The black part is the parameter range. If you drag the left edge of the black part, the [Min] value will change. If you drag the right edge, the [Max] will change.

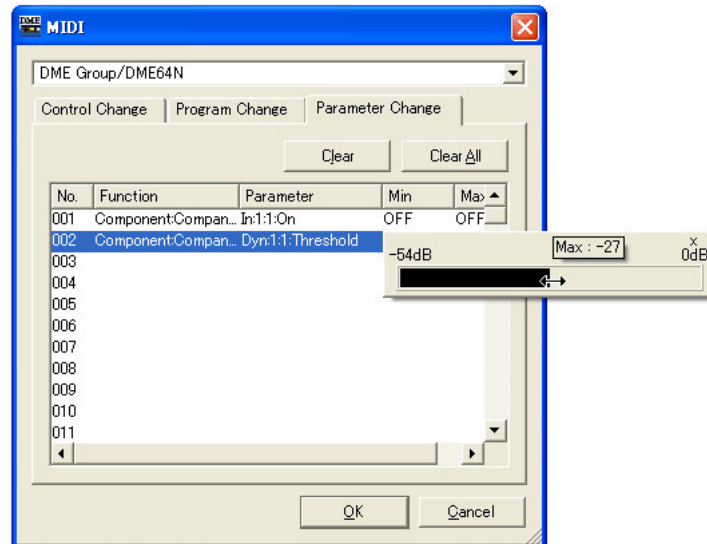

■ [Clear] Button

Clears the assignment for the parameter change selected in the list, so that nothing will be assigned to it.

■ [Clear All] Button

Clears all parameter change assignments.

User Defined Button (User Defined Parameters)

User Defined Parameters

Parameters that the user can operate using function keys <F1> through <F6> in the DME64N/24N unit or ICP1 are called “User Defined Button.” Frequently changed parameters can be assigned in advance to any of 24 (four pages times six) presets, and operated on the DME64N/24N unit or ICP1 even if DME Designer is not being used.

This function sets parameters in DME Designer that can be called by these function keys <F1> through <F6>.

In DME Designer, user defined parameter settings are made using the “User Defined Button” dialog box. The user defined parameter settings are shared between device group configurations.

“User Defined Button” Dialog Box

When you click [User Defined Button] in the [Tools] menu, the “User Defined Button” dialog box is displayed.

NOTE

Does not apply to SP2060 units

Names and Functions

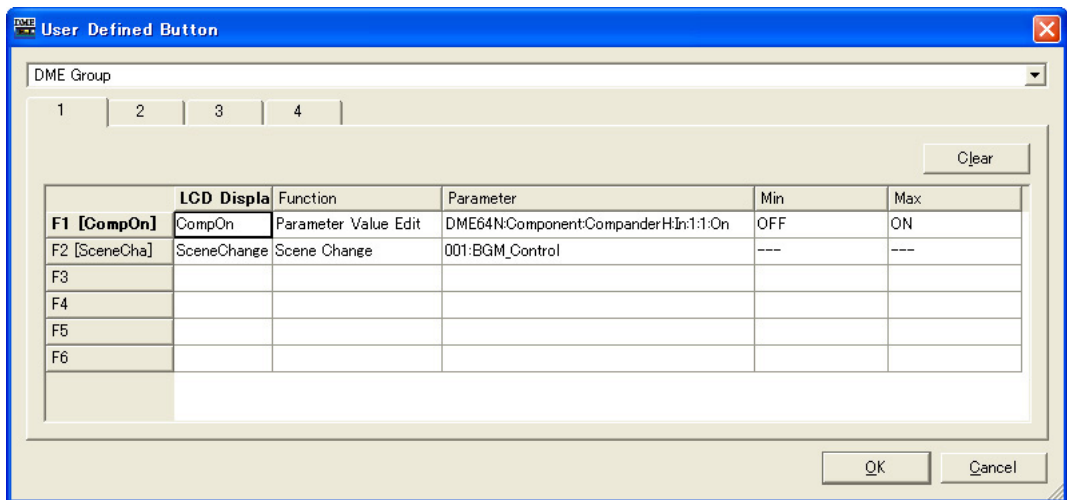

[Group]

Select the device group to be set up from the list.

[1]/[2]/[3]/[4] Tabs

Switches the set to which settings will apply. You can set up to six function keys in each set. The user defined parameters set on a single tab are displayed on one page in the DME64N/24N unit or ICP1 main screen.

Function Keys

The function keys are displayed in the leftmost column of the table. When you enter text for [LCD Display], a short name with up to eight characters will be created and displayed to the right of the function key.

Function

Specifies the function to be assigned to the function keys.

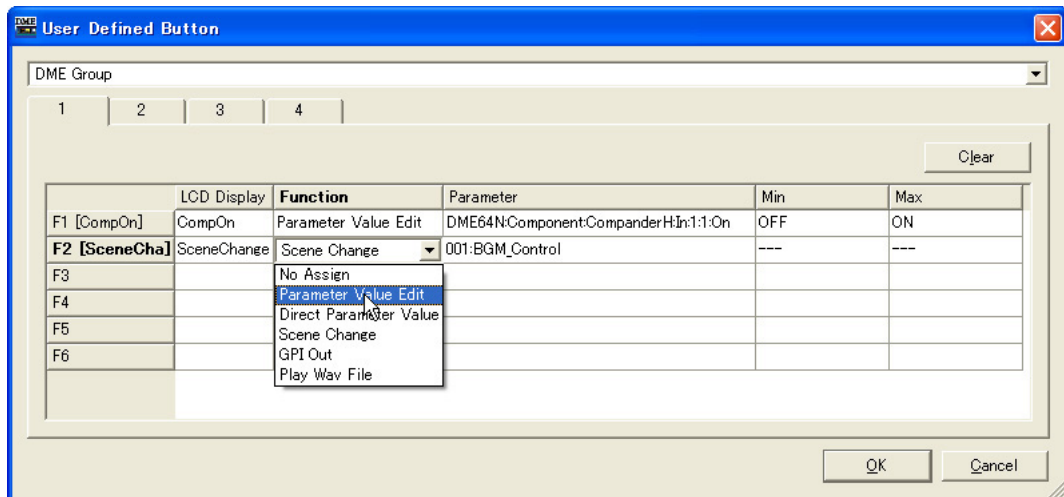

- **[No Assign]**
No assignment. Select this option to clear an assigned function.
- **[Parameter Value Edit]**
Allows the parameter specified in the [Parameter] field to be changed.

NOTE

Components for user modules are also listed in a hierarchal display, but if user module security is enabled, the components are not displayed. However, parameters displayed in the user module editor are displayed here.

- **[Direct Parameter Value]**
Allows the value of a parameter to be set directly. The target parameter is specified in the [Parameter] field, and the value to be set is specified in the [Max] field.

NOTE

Components for user modules are also listed in a hierarchal display, but if user module security is enabled, the components are not displayed. However, parameters displayed in the user module editor are displayed here.

- **[Scene Change]**
Allows scene recall. The scene to be recalled is specified in the [Parameter] field.
- **[GPI OUT]**
Allows GPI output. The GPI setting is made in the [Parameter] field.
- **[Play Wav File]**
Allows initiation of Wave file playback. The Wave file setting is made in the [Parameter] field. Wave files set by the Wav File manager can be specified. Files can not be selected unless a Wav File Player is included in the DME configuration.

Parameter

Sets the parameter assigned to each function key. If you click here, a list will be displayed. This list displays the parameters that are included in the current configuration. Select the parameter you want called by the function key.

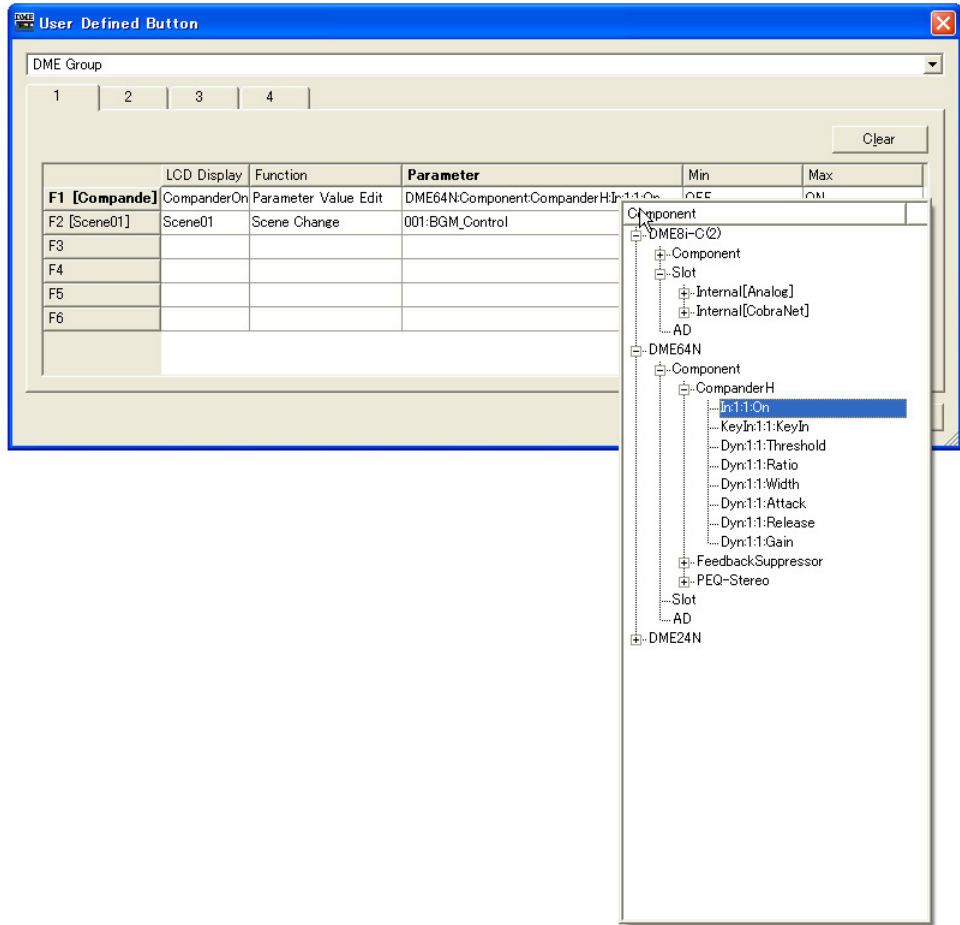

LCD Display

Sets the text displayed on the DME unit or ICP1. Click the [LCD Display] box and enter text. Up to 23 characters can be entered into the [LCD Display] box.

After you confirm the name by pressing the <Enter> key, a short name will be created and displayed in the function key area as follows: "F1 [shortnam]." The short name will also be displayed in the DME unit or ICP1 main display. A short name is automatically created with up to eight characters for display as the user defined parameter name on the DME unit or ICP1 main screen

Min, Max

Sets the lower and upper limits for a parameter.

■ [Clear] Button

Clears assignments for the selected function keys. This is the same as "No Assign."

■ [OK] Button

Accepts the changed settings and closes the dialog box.

■ [Cancel] Button

Closes the dialog box without changing the settings.

Setting User Defined Parameters

Set the user defined parameter.

- 1 Create a configuration.
- 2 Click [User Defined Button] in the [Tools] menu.
The “User Defined Button” dialog box will be displayed.

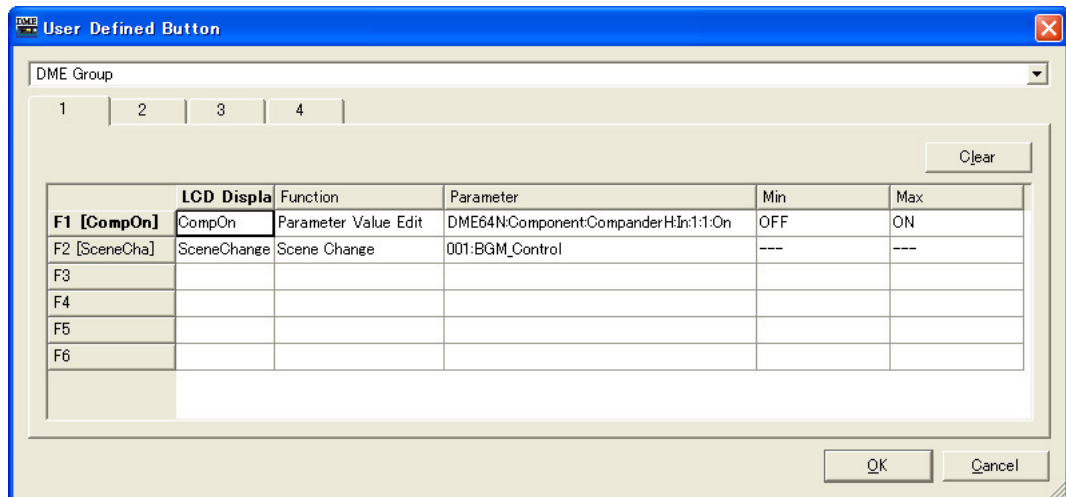

- 3 Click one of the tabs numbered [1] through [4] to select the set of user defined parameters you will assign your parameters to.
The four tabs correspond to the pages on the DME unit or ICP1 main screen.
- 4 Click the [Parameter] box for the function key to which you will assign the parameter.
A list of parameters included in the current configuration will be displayed.
- 5 Select the parameter to assign to the function key.
- 6 Click the [LCD Display] box and enter text for the user defined parameter name.
The [LCD Display] box can accept up to 23 characters, but only eight characters can be displayed in the DME unit or ICP1 main screen. When making a user defined parameter name, the first eight characters should be understandable.

Note

When making multiple registrations, you can save time by first setting just the [Parameter] box for all keys, then setting the [LCD Display] box names. When you enter a user defined parameter name into an [LCD Display] box and press the <Enter> key to confirm it, the next [LCD Display] box down will be selected, and you can enter text there immediately.

DAW Control

When you click [DAW Control] on the [Tools] menu, the “DAW Control” dialog box is displayed. Here you can make settings for when the DME64N/24N is controlled from a DAW controller. This is set for each zone configuration. The setting can be made only when in offline status.

NOTE

DAW Control can be set on DME64N/24N units only.

NOTE

DAW control editing can be performed only by users for whom the [Edit] security checkbox has been checked.

Names and Functions

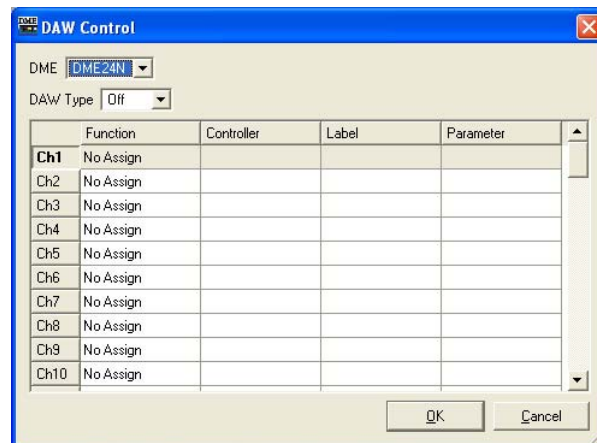

■ [DME]

From the list, select the DME64N/24N where you will be making settings.

■ [DAW Type]

Select the DAW type. The available settings are: MIDI, DAW(Type1), and DAW(Type2). The [DAW Type] parameter has the same function as Protocol in the “Utility” dialog box MIDI tab.

MIDI: Use this setting when any MIDI device other than a general purpose ProTools controller (HUI protocol) or general-purpose Logic or Cubase controller (Mackie control protocol) is to be connected.

DAW (Type1): Use this setting when a general purpose ProTools controller (HUI protocol) is to be connected.

DAW (Type2): Use this setting when a general purpose Logic or Cubase controller (Mackie control protocol) is to be connected.

■ DAW Control Table

The following can be set for each channel from 1 to 64: [Function], [Controller], [Label], [Parameter].

[Function]

Selects the function that will be changed by the DAW controller. If you click here, a list will be displayed.

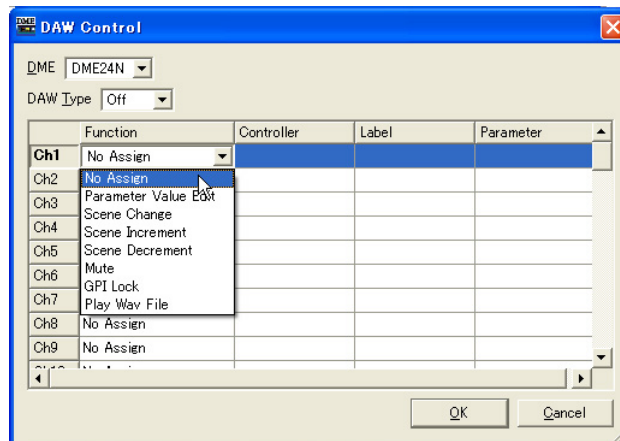

- **[No Assign]**
Makes no assignments. Select this when you are erasing an already set assignment.
- **[Parameter Value Edit]**
Allows the parameter of the component specified in the [Parameter] field to be changed.

NOTE

Components for user modules are also listed in a hierarchal display, but if user module security is enabled, the components are not displayed. However, parameters displayed in the user module editor are displayed here.

- **[Scene Change]**
Recalls a scene. The scene is recalled even if the current scene, and the one changed by the DAW controller, are the same.
When a selection has been made, [SCENE] is displayed in the [Label] field. The last scene is set in the [Parameter] field.
- **[Scene Increment]**
Sets the scene increment. Recalls the next valid scene after the current scene.
When a selection has been made, [SINC] is displayed in the [Label] field.
- **[Scene Decrement]**
Selects the scene decrement. Recalls the next valid scene before the current scene.
When a selection has been made, [SDEC] is displayed in the [Label] field.
- **[Mute]**
Sets all mute. Mute is set ON and OFF by the DAW controller.
When a selection has been made, [MUTE] is displayed in the [Label] field.
- **[Component]**
Changes the component parameters. Selectable component names that are arranged in the configuration are displayed in a list.
When selected, the first parameter included in the component is set in the [Parameter] field.
- **[GPI Lock]**
Assigns GPI Lock. GPI Lock is set ON and OFF by the DAW controller.
When a selection has been made, [LOCK] is displayed in the [Label] field.
- **[Play Wav File]**
Allows initiation of Wave file playback. The Wave file setting is made in the [Parameter] field. Wave files set by the Wav File manager can be specified. Files can not be selected unless a Wav File Player is included in the DME configuration.

[Controller]

Selects a controller from the list when [Parameter Value Edit] is set in [Function]. [Switch], [Fader], or [Knob] can be selected.

[Label]

Enter a label. Double-click to enter the text. You can enter up to 16 characters of text. Set the value with the <Enter> key, or cancel it with the <ESC> key.

NOTE

If [Scene Change], [Scene Increment], [Scene Decrement], [Mute], or [GPI Lock] is selected for [Function], the label name is fixed.

[Parameter]

If [Scene Change], [Parameter Value Edit] or [Play Wav File], is set in [Function], set the parameters.

If you click here, a list will be displayed.

- **When [Scene Change] is set in [Function]**
Displays scenes that can be selected.
- **When [Parameter Value Edit] is set in [Function]**
Selectable parameters are displayed.
- **When [Play Wav File] is set in [Function]**
Selectable Wave files are displayed.
To select a Wave file, the file must first be specified in the Wav File Manager and then the Wav File Player must be placed in the DME configuration.

[OK] Button

Applies any setting changes and closes the window.

[Cancel] Button

Closes the window without changing any settings.

Remote Control Setup List

When you click the [Remote Control Setup List] command on the [Tools] menu, the “Remote Control Setup List” dialog box is displayed.

Registers the parameters to be controlled from an external controller.

NOTE

DME V3.8 or later/DME Satellite units allow remote control via the [NETWORK] connector as well as via the [REMOTE] connector. The port to be used is specified via the “Remote” tab of the “Utility” dialog box (page 172).

NOTE

For details about the communication protocol, refer to the “DME Remote Control Protocol Specifications” on the Yamaha Pro Audio website (URL below).
<http://www.yamahaproaudio.com/>

NOTE

Does not apply to SP2060 units.

Names and Functions

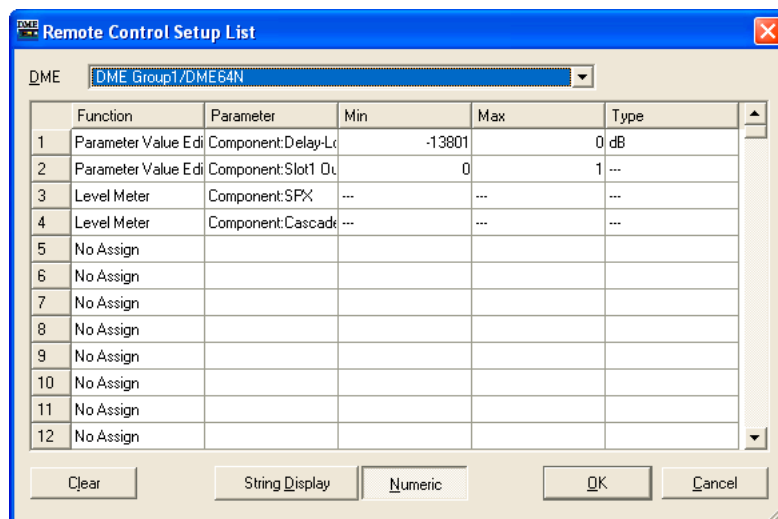

[DME]

From the list, select the DME where you will be making settings.

[Function]

Select [No Assign], [Parameter Value Edit] or [Level Meter].

[Parameter]

Specifies the parameter to be controlled. A list of parameters will be displayed according to the selection of [Function].

NOTE

Components for user modules are also listed in a hierarchical display, but if user module security is enabled, the components are not displayed. However, parameters displayed in the user module editor are displayed here.

[Min]/[Max]

Displays the minimum and maximum values for the parameter.

[Type]

Selects a fader curve when level, etc., is select for [Parameter].

Select [dB] to directly control the level in dB, or [Curve Table] to use one of the DME fader curves for level adjustment.

[Clear] Button

Clears the selected row.

[String Display]/[Numeric] Buttons

Switches the parameter value display format.

String Display: The value displayed in the editor windows.

Numeric: The internal value.

[OK] Button

Applies any setting changes and closes the window.

[Cancel] Button

Closes the window without changing any settings.

Internal HA Control

The gain and phantom power (+48V) of the DME24N/DME8i-C/DME4io-C/DME8i-ES/DME4io-ES internal head amplifiers can be controlled from a PM5D, and LS9 or other compatible mixing console. The digital mixer communicates serially with one DME unit in a device group, and that DME unit controls all other DME units in the group. Only one DME unit in a device group may be connected to a digital mixer for direct serial communication. This can be a DME unit other than the group master or a DME unit that does not have head amplifiers.

There are three possible ways to connect a DME unit to a digital mixer for serial communication: 1) via the [REMOTE] connector, 2) via CobraNet, and 3) via EtherSound. In all cases it is necessary to set the communication port that the DME unit will use, and if CobraNet or EtherSound are to be used it is necessary to make the appropriate settings for those protocols as well.

It is also necessary to assign an ID to the internal head amp of the DME that is to be controlled ([page 146](#)). Since AD8HR protocol is used for communication between the DME units and digital mixer, the head amp IDs allow multiple DME units to be viewed and controlled as AD8HR head amps from the mixer. Details on making the appropriate settings are provided on the following pages.

NOTE

- Only one mixer can be communicated serially within each device group.
 - If the connection between DME series units is interrupted, communication with DME units with ID numbers higher than that of the unit at which the interruption occurred will not be possible.
 - The variable range of GAIN differs between the AD8HR and the DME series. You cannot use the mixer to specify a value that exceeds the variable range of the DME series.
 - If the DME unit that is communicating serially with the digital mixer is changed, or its internal head amp ID assignment is changed, it will be necessary to restart the DME unit.
-

Remote Connection

Connect the digital mixer to the [REMOTE] connector of one of the DME units, and set the port to be used for head amp control to “Remote” via the [Internal HA Control] parameter in the “Remote” tab in the “Utility” dialog box (page 172). Use an Ethernet cable connected to the [NETWORK] connectors to make connections between DME series units.

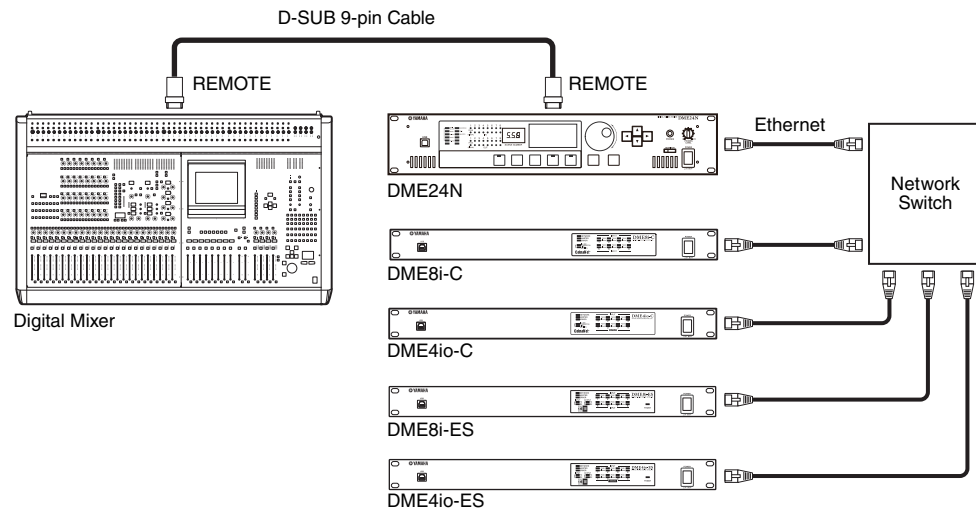

NOTE

- Only control signals are transmitted and received via the REMOTE connection. Audio connections must be made separately.
- Connection can also be made to the [REMOTE] connector of a DME unit with built-in head amplifiers.

CobraNet Connection

Use a CobraNet interface card such as the MY16-CII to make CobraNet connections between the digital mixer and DME units. Use an Ethernet cable connected to the [NETWORK] connectors to make connections between DME series units. The port to be used for head amp control is specified via the [Internal HA Control] parameter in the “Remote” tab in the “Utility” dialog box ([page 172](#)). Select “Slot 1” when the DME unit to be used for serial communication is a DME24N, “Slot 1” through “Slot 4” if it is a DME64N, or “CobraNet” if it is a DME Satellite unit. The settings for all other DME units should be “OFF”.

It is also necessary to match the CobraNet serial communication channels of the interface card installed in the serially connected DME unit with that of the interface card in the digital mixer. Refer to [page 495](#) for DME8i-C/8o-C/4io-C information. Refer to the CobraNet Manager Lite for Yamaha Owner’s Manual for more information on setting the MY16-CII. Set the serial channel for all other devices to “OFF”.

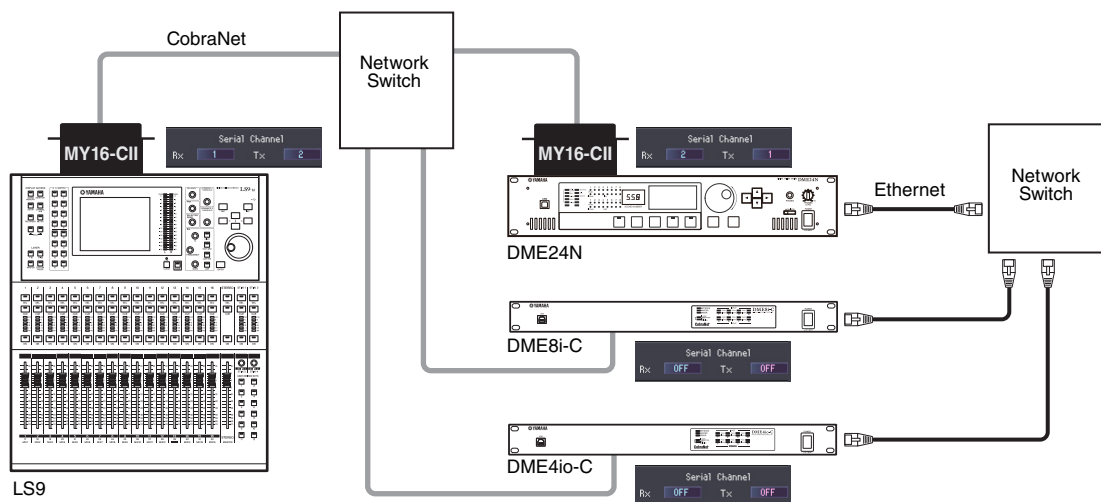

NOTE

When two MY16-CII or similar CobraNet interface cards are installed in an LS9-32 in order to control multiple DME units, use the COMM PORT parameter in the LS9 EXTERNAL HA display to select the slot to be used.

EtherSound Connection

■ Digital Mixers Without a [REMOTE] Connector

Use an EtherSound interface card such as the MY16-ES64 to make EtherSound connections between the digital mixer and DME units. Use an Ethernet cable connected to the [NETWORK] connectors to make connections between DME series units.

The port to be used for head amp control via direct serial communication with a DME unit is specified by the [Internal HA Control] parameter in the “Remote” tab in the “Utility” dialog box (page 172). Select “Slot 1” when the DME unit to be used for serial communication is a DME24N, “Slot 3” or “Slot 4” if it is a DME64N, or “EtherSound” if it is a DME Satellite unit. The settings for all other DME units should be “OFF”.

Use the AVS-ESMonitor software from AuviTran to specify the following EtherSound settings for both the digital mixer’s interface card and the DME unit.

- Serial Communication mode: Unicast for bidirectional operation.
- AD8HR Remote Option: Mode 2
- Baud Rate: 38400

In order to turn serial communication off for the interface cards installed in all other DME units, set the Serial Communication mode to “Slave”.

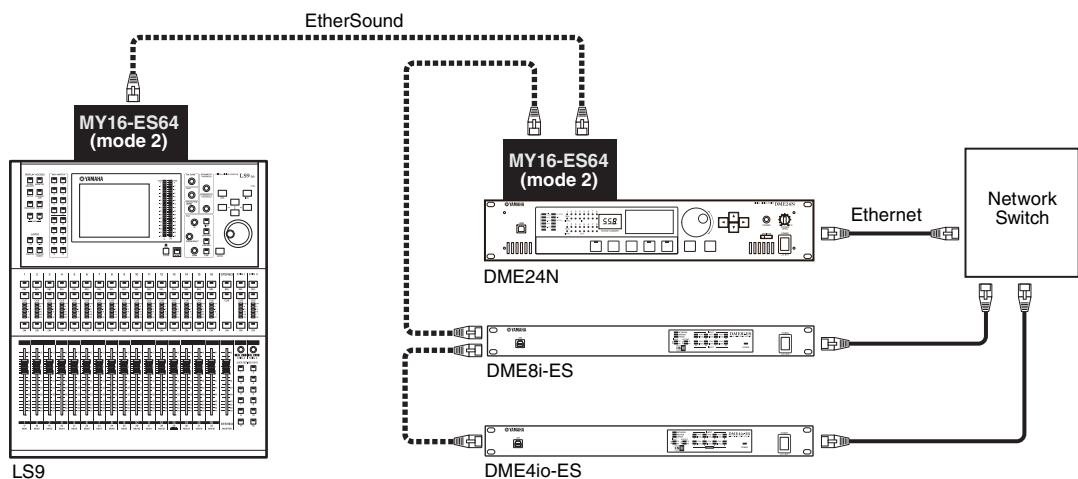
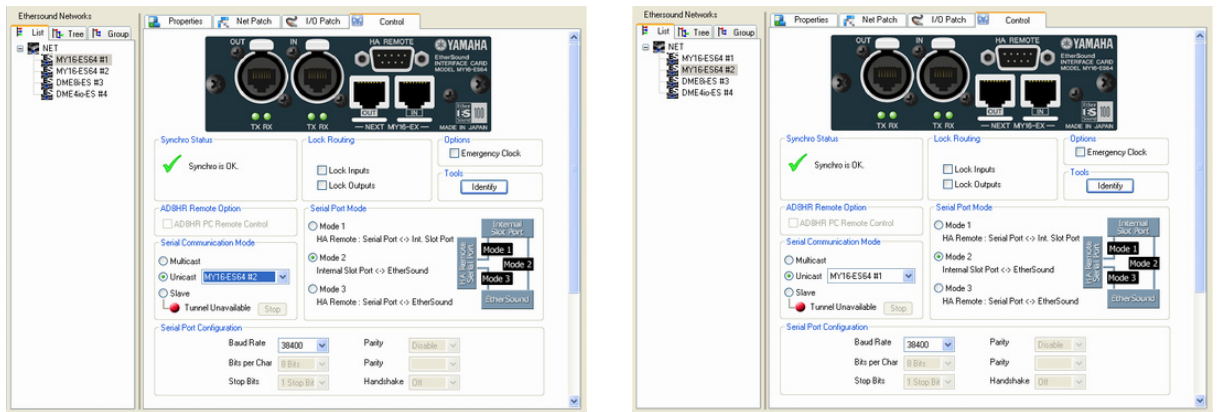

NOTE

- When installing an MY16-ES64 or similar EtherSound interface card in an LS9-32, be sure to install it in SLOT 1. Also select “SLOT 1” using the COMM PORT parameter in the LS9 EXTERNAL HA display.
- DME24N units with firmware version V3.04 or later are compatible.
- You can download the AVS-ESMonitor software from the AuviTran website. <http://www.auvitran.com/>

■ Digital Mixers With a [REMOTE] Connector

Connect the mixer's [REMOTE] connector to the MY16-ES64 or similar EtherSound interface card via a 9-pin D-sub cross cable, and make the appropriate EtherSound connections between the interface card and DME units. Use an Ethernet cable connected to the [NETWORK] connectors to make connections between DME series units.

The port to be used for head amp control via direct serial communication with a DME unit is specified by the [Internal HA Control] parameter in the "Remote" tab in the "Utility" dialog box (page 172).

Select "Slot 1" when the DME unit to be used for serial communication is a DME24N, "Slot 3" or "Slot 4" if it is a DME64N, or "EtherSound" if it is a DME Satellite unit. The settings for all other DME units should be "OFF".

Use the AVS-ESMonitor software from Auvitrans to specify the EtherSound serial communication settings for both the digital mixer's interface card and the interface card installed in the serially connected DME unit.

- Serial Communication mode: Unicast for bidirectional operation.
- Set the digital mixer's interface card to "Mode 3," and the DME unit to be used for serial communication to "Mode 2."
- Baud Rate: 38400

In order to turn serial remote communication off for the interface cards installed in all other DME units, set the Serial Communication Mode to "Slave".

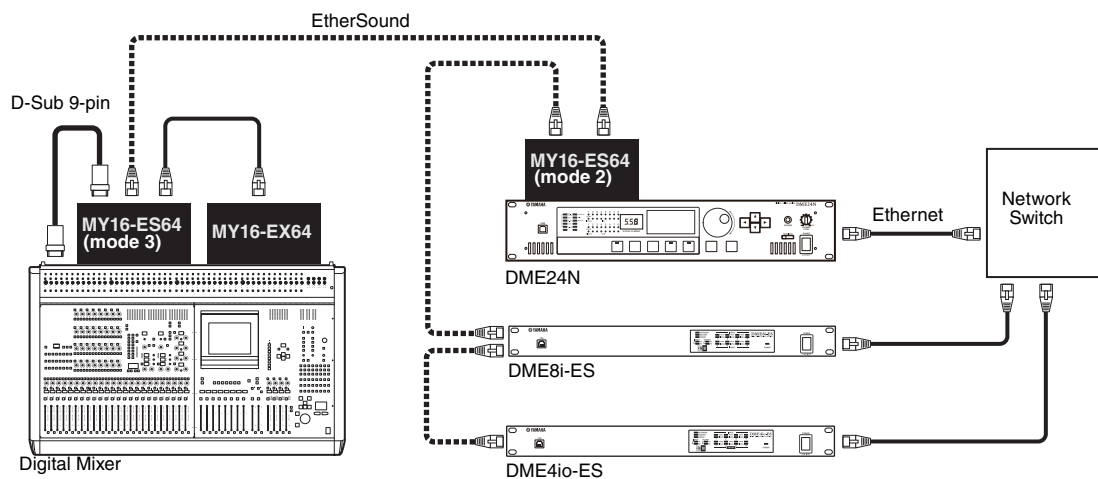
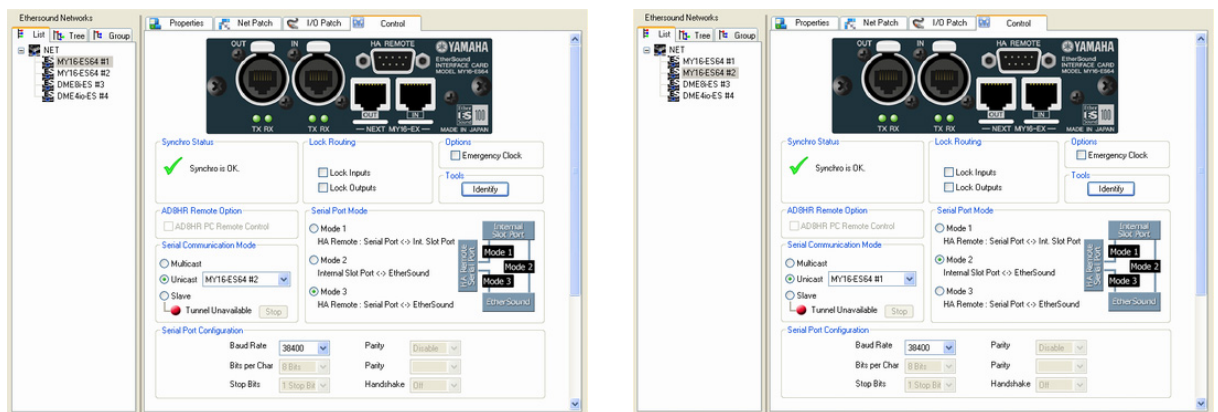

NOTE

- DME24N units with firmware version V3.04 or later are compatible.
- You can download the AVS-ESMonitor software from the Auvitrans website.
<http://www.auvitrans.com/>

Setting the Internal Head Amp ID

Click [Internal HA Control] in the [Tools] menu to open the “Internal HA Control” dialog box. ID numbers for the internal DME head amplifiers that are to be controlled from the digital mixer are assigned via this dialog box. The ID numbers are displayed as AD8HR IDs on the digital mixer. Click on a [Device Label] field and select the target DME unit from the drop-down menu that appears.

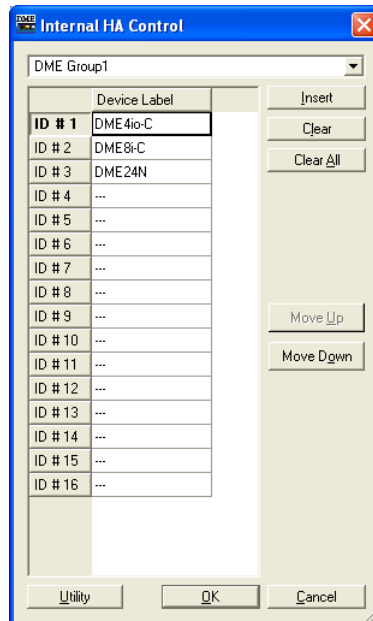

Device Group Select Field

Selects the target device group.

[Device Label]

Selects the DME unit to which head amp control is to be applied.

[Insert] Button

Inserts an unassigned row at the currently selected DME in the list. The originally selected DME will be moved to the next row.

[Clear] Button

Deletes the currently selected DME from the list.

[Clear All] Button

Clears all settings from the list.

[Move Up]

Moves the selected DME up one row in the list.

[Move Down]

Moves the selected DME one row down in the list.

[Utility] Button

Opens the “Remote” tab in the Utility dialog box. Select the DME unit to be used for serial communication with the digital mixer and specify the port to be used for head amp control via the [Internal HA Control] parameter.

[OK] Button

Applies the settings and closes the dialog box.

[Cancel] Button

Closes the dialog box without applying the setting changes.

Parameter List

When you click [Parameter List] in the [Tools] menu, the “Parameter List” dialog box is displayed. A list of parameters in the current configuration of the current zone are displayed. Here you can check things like the parameter IDs. You can also print the list of parameters.

When the dialog box is opened or when a DME is selected from the [DME] list, the parameter values are displayed.

NOTE

Does not apply to SP2060 units.

Names and Functions

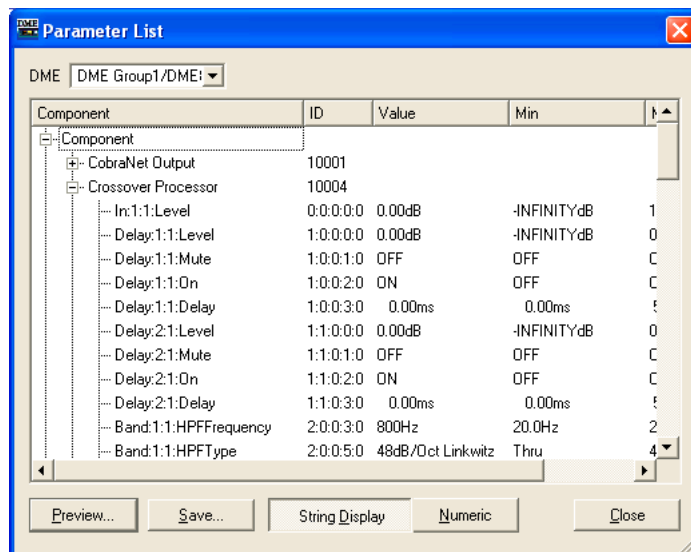

■ [DME]

From the list, select the DME where you will be making settings. Components in the selected DME are displayed in the component list.

Component List

The components and user modules included in the DME, their IDs, and the component parameters are displayed in hierarchal list. The AD and slot are also displayed.

NOTE

Components for user modules are also listed in a hierarchal display, but if user module security is enabled, the components are not displayed. However, parameters displayed in the user module editor are displayed here.

[ID]

Displays the component or parameter ID.

The following is displayed for the parameter ID: “Element No. : X : Y : Parameter No. : Index No.”

[Value]

Displays the value for the parameter.

[Min]/[Max]

Displays the minimum and maximum values for the parameter.

NOTE

The displayed parameter values are those that were in effect when the dialog box was opened or when the displayed DME was selected from the [DME] list. They cannot be changed here.

■ [Preview] Button

Prints a list of parameters. When you click this button a preview screen is displayed.

■ [Save] Button

Saves the parameter list as a CSV file. When you click this button, the standard operating system save dialog box is displayed.

NOTE

The CSV format is a comma delimited text file that can be read by many types of software, such as word processor, spreadsheet, or database programs.

NOTE

The parameter values are saved in the display format selected by the [String Display] or [Numeric] button.

■ [String Display]/[Numeric] Buttons

Switches the parameter value display format.

String Display: The value displayed in the editor windows.

Numeric: The internal value.

■ [Close] Button

Closes the dialog box.

■ Printing a List of Parameters

Prints all parameters for the component selected in the list, all parameters for the selected DME, or all parameters for all DMEs.

When you click the [Preview] button, the dialog box display will change, and the print preview will be displayed in the center. Buttons will be added to the upper part of the dialog box.

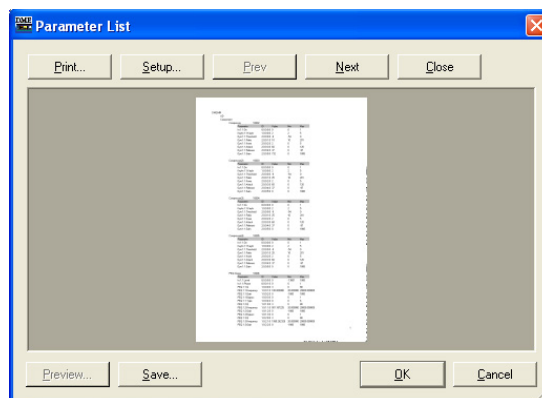

[Print] Button

Prints a list of parameters. Clicking here displays the "Print" dialog box. When you click the [Print] button, printing begins.

■ [Setup] Button

Clicking here displays the “Print Setup” dialog box. Here you can set the paper size, paper orientation, and font.

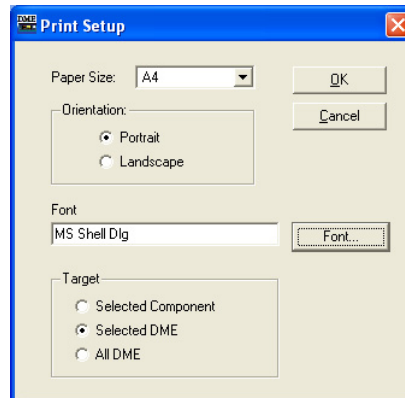

[Paper Size]

Select the paper size from the list.

[Orientation]

Set the orientation of the paper by clicking one of the radio buttons.

- **[Portrait]**
Prints on the paper with it oriented vertically.
- **[Landscape]**
Prints on the paper with it orientated horizontally.

[Font]

Displays the set font. Clicking the [Font] button displays the “Font” dialog box, where you can change the font.

[Target]

Set the parameters to be printed by clicking one of the radio buttons.

- **[Selected Component]**
Prints all parameters for the component selected in the list.
- **[Selected DME]**
Prints all parameters for the selected DME.
- **[All DME]**
Prints all parameters for all DMEs.

[Close] Button

Ends the preview and returns the screen to the original dialog box.

[Prev] Button/[Next] Button

Switches the page being previewed when there are multiple pages. The [Prev] button goes to the previous page. The [Next] button goes to the next page.

Component Lock

Click [Component Lock] in the [Tools] menu to display the Component Lock dialog.]

NOTE

Does not apply to SP2060 units

Names and Functions

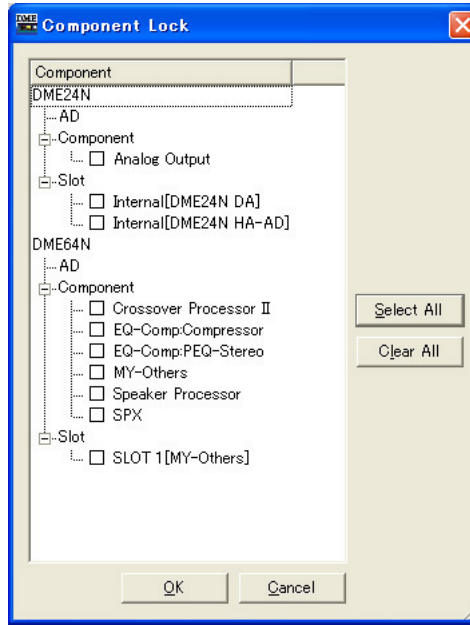

The component/user module names included in the DME will be displayed. AD and Slot will also be displayed.

When the checkbox to the left of the component name is checked, the component is locked so that it is not possible to change parameters from a PM5D or other external device controlling the DME unit via the RS-422 interface. While the component is locked it is still possible to control the internal DME head amps via the Internal HA Control function. The lock settings will be transferred to the DME when the unit is placed on-line. The settings can only be changed while off-line.

NOTE

If user module security is enabled the components will not be displayed. Components displayed by the User Module Editor will be displayed.

NOTE

Only users who's [Edit] box is checked can edit the lock status.

■ [Select All] Button

Checks all component checkboxes.

■ [Clear All] Button

Clears all component checkboxes.

■ [OK] Button

Enters the settings and closes the dialog box.

■ [Cancel] Button

Closes the dialog box without entering the settings.

Scene Link Manager

Either click the [Scene Link Manager] item in the [Tools] menu, or the [Scene Link] button the “Scene Manager” window to open the “Scene Link Manager” window.

“Scene Link Manager” Window

This window allows setup and recall of scene linking between DME groups and SP2060 units. Scene linking makes it possible to simultaneously recall scenes on multiple DME groups and/or SP2060 units. Up to 999 scene link setups can be specified.

NOTE

Only users with security status in which [Edit] is checked can edit this feature.

NOTE

This is a DME Designer feature and it does not affect scene recall or store operations carried out from the device panel or external devices.

Names and Functions

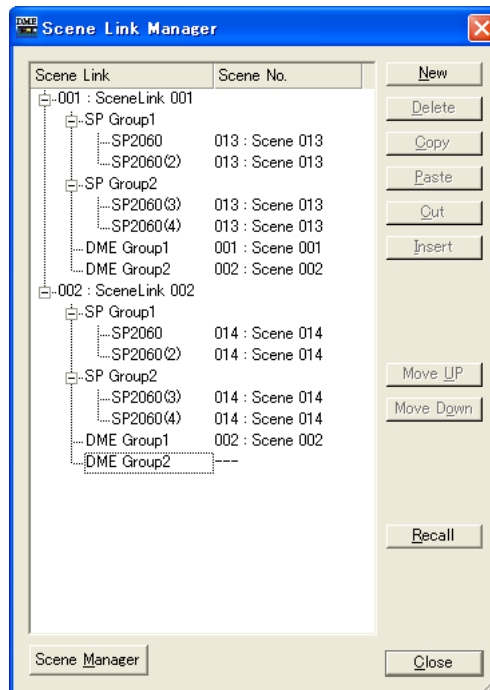

■ Scene Link Tree View

Displays the scene link name, DME group and/or SP2060 scene number, and scene name for each Scene Link setup. Clicking on scene number or scene name opens a list from which a new selection can be made. Click on the scene link name to edit it.

■ [New] Button

Creates a new scene link setup. Enter a name and click the [OK] button to add a new scene link setup.

■ [Delete] Button

Deletes the scene link setup currently selected in the scene link tree view. When clicked an “Are you sure?” dialog will appear. Click the [Yes] button to delete the selected scene link setup. Click the [No] button to abort the scene link delete operation. The [No] button will be grayed out and inoperable if a scene link setup is not selected.

■ [Copy] Button

Copies the selected scene link setup. The [Copy] button will be grayed out and inoperable if a scene link setup is not selected.

■ [Paste] Button

Pastes a cut or copied scene link setup to the currently selected scene link setup in the scene link tree view. The selected scene link setup will be overwritten. The [Paste] button will be grayed out and inoperable if no scene link setup has been cut or copied.

■ [Cut] Button

Cuts the selected scene link setup. The [Cut] button will be grayed out and inoperable if a scene link setup is not selected.

■ [Insert] Button

Inserts a cut or copied scene link at the currently selected scene link position in the scene link tree view. The selected scene link setup and all others below it will be moved down one position. The [Insert] button will be grayed out and inoperable if no scene link setup has been cut or copied.

■ [Move UP] Button

Moves the currently selected scene link setup up one position in the scene link view. The [Move UP] button will be grayed out and inoperable if a scene link setup is not selected.

■ [Move Down] Button

Moves the currently selected scene link setup down one position in the scene link view. The [Move Down] button will be grayed out and inoperable if a scene link setup is not selected.

■ [Recall] Button

Recalls the scene number specified for the currently selected scene link setup in the scene link view to the corresponding devices. The [Recall] button will be grayed out and inoperable if a scene link setup is not selected.

NOTE

Scenes can only be recalled in real time for DME and SP2060 units in an online device group.

■ [Scene Manager] Button

Opens the “Scene Manager” window.

■ [Close] Button

Closes the window.

SP2060 Library Manager

Click the [SP2060 Library Manager] item in the [Tools] menu to open the “SP2060 Library Manager” window.

“SP2060 Library Manager” Window

Allows editing of SP2060 Speaker Processor component libraries. Up to 60 libraries can be stored for each component, and up to 360 libraries can be stored for each SP2060 unit

NOTE

Only users with security status in which [Edit] is checked can edit this feature.

Names and Functions

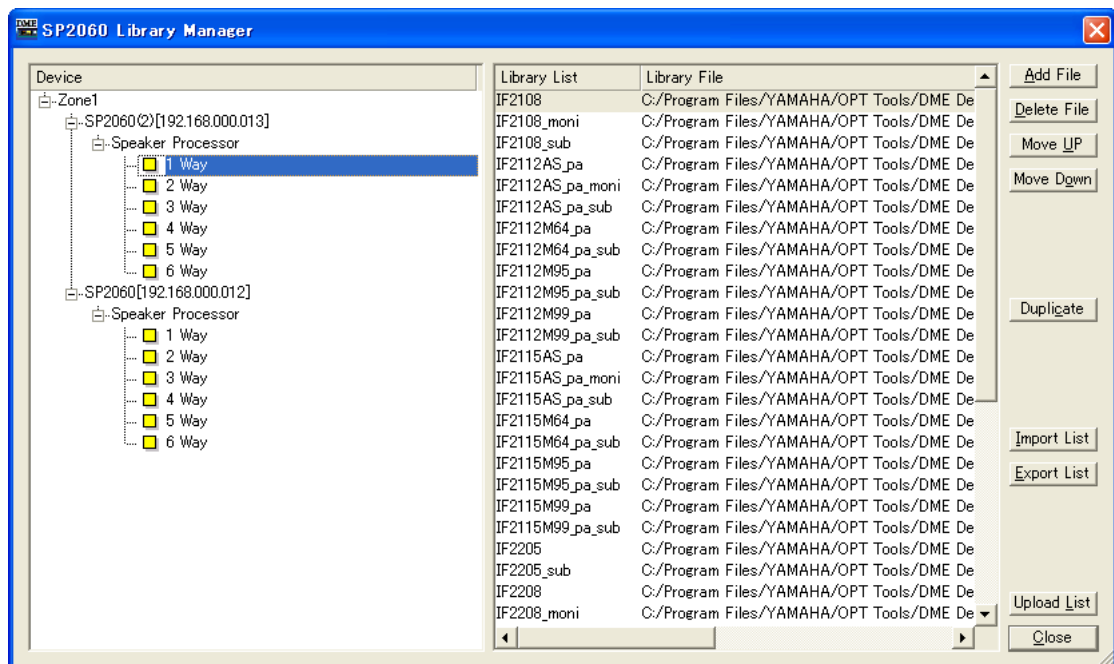

Speaker Processor List

Displays a list of the SP2060 units connected to the specified port.

Library List

Library titles and library file names are displayed in this list. The default titles are the file names minus the file extension. Click a title to edit it. Titles can be up to 23 characters in length, but the SP2060 display will only show 16 characters. 2-byte characters can also be used, but they will not appear on the SP2060 display.

[Add File] Button

Adds a library file saved by the component editor (.cel extension) to the SP2060 selected in the SP2060 list. When the [Add File] button is clicked the “Open” window will appear. Select a library file and click the [Open] button to add the library.

The [Add File] button will be grayed out and inoperable if no SP2060 is selected.

Refer to the “Libraries” section on [page 364](#) for information on component editor libraries.

■ [Delete File] Button

Deletes the selected library from the library list. When this button is clicked an “Are you sure?” dialog box will open. Click the [YES] button to delete the selected library. Click the [NO] button to abort the library delete operation. The [Delete] button will be grayed out and inoperable if a library is not selected.

■ [Move UP] Button

Moves the currently selected library up one position in the library list. The [Move UP] button will be grayed out and inoperable if a library is not selected.

■ [Move Down] Button

Moves the currently selected library down one position in the library list. The [Move Down] button will be grayed out and inoperable if a library is not selected.

■ [Duplicate] Button

Copies the library from the SP2060 selected in the SP2060 list to a different SP2060. When the [Copy] button is clicked the “Duplicate” window will open. Select the destination SP2060 and click the [OK] button to copy the library. Multiple destination SP2060 units can be selected. Click the [Cancel] button to abort the library copy operation. The [Copy] button will be grayed out and inoperable if no SP2060 is selected.

■ [Import List] Button

Imports a library file (.lff extension) to the SP2060 selected in the SP2060 list. When the [Import List] button is clicked the “Open” window will appear. Select a library file and click the [Open] button to import all libraries included in the library file. Click the [Cancel] button to abort the import operation. The [Import List] button will be grayed out and inoperable if no SP2060 is selected.

■ [Export List] Button

Exports and saves the library of the SP2060 selected in the SP2060 list as a library file (.lff extension). When the [Export List] button is clicked the “Save As” window will appear. Select a file format and click the [Save] button to save the library file. If you select the “Library List File” format only the paths will be saved, and if you select the “Library List File with data” format the actual library data will be saved to the file. Click the [Cancel] button to abort the export operation. The [Export List] button will be grayed out and inoperable if no SP2060 is selected.

■ [Upload List] Button

Sends the SP2060 library to an SP2060 unit. When the [Export List] button is clicked the “Select Device” window will open. Select an SP2060 and click the [OK] button to send the library. Multiple destination SP2060 units can be selected. Click the [Cancel] button to abort the send operation.

NOTE

The library is not sent to the SP2060 unit until the [OK] button is clicked even when the SP2060 unit is online. It can be sent even when the SP2060 unit is offline.

■ [Close] Button

Closes the window.

Communication Port Setup

Click the [Communication Port] item in the [Setup] menu to open the “Communication Port” dialog box. In this window you can set the communication port of the master current device to be used by the DME Designer.

NOTE

Selects either the USB-MIDI Driver or DME-N Network Driver for the communication port. Refer to the “DME Setup Manual” for driver installation and setup instructions.

NOTE

Only USB x-1 can be selected for a DME Satellite unit connected via USB.

“Communication Port” Dialog Box

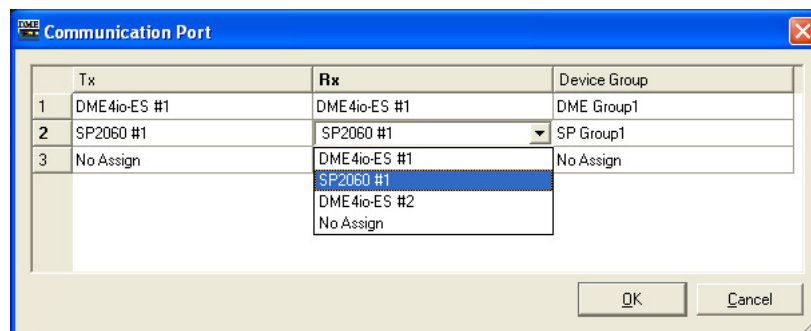

[Tx]

Selects the driver communication port to be used for transmission.

[Rx]

Selects the driver communication port to be used for reception.

[Group]

Select the device group to be set up from the list.

Shortcut Keys

Click [Shortcut Keys] in the [Setup] menu to display the “Shortcut Keys” dialog.

Names and Functions

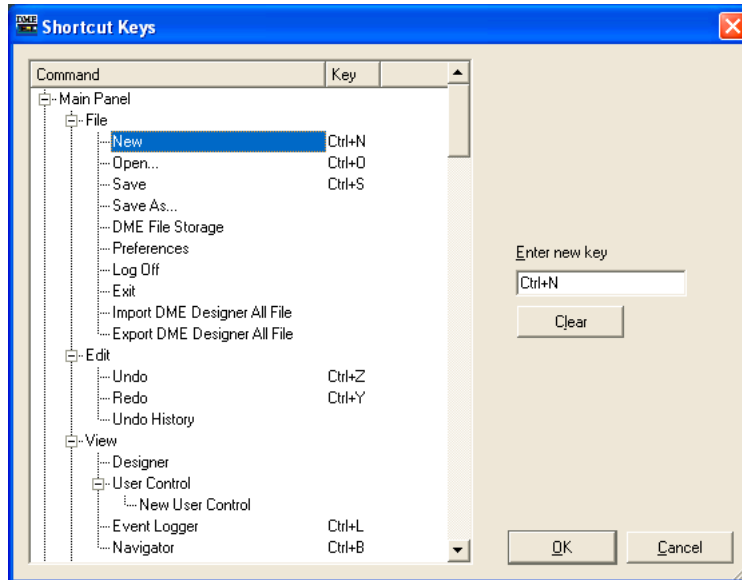

Click to select the desired shortcut item.

■ [Enter New Key]

If assigned, the current shortcut will be displayed.
A shortcut entered via the computer keyboard will be displayed.

■ [OK] Button

Enters the settings and closes the dialog box.

■ [Cancel] Button

Closes the dialog box without entering the settings.

Security (Creating Users and Making User Settings)

When you click the [Security] command on the [Setup] menu, the “Security” dialog box is displayed. Here you can create and delete users. You can also set the security level for each user. Users are saved as DME Designer settings. You don’t need to create users for each file.

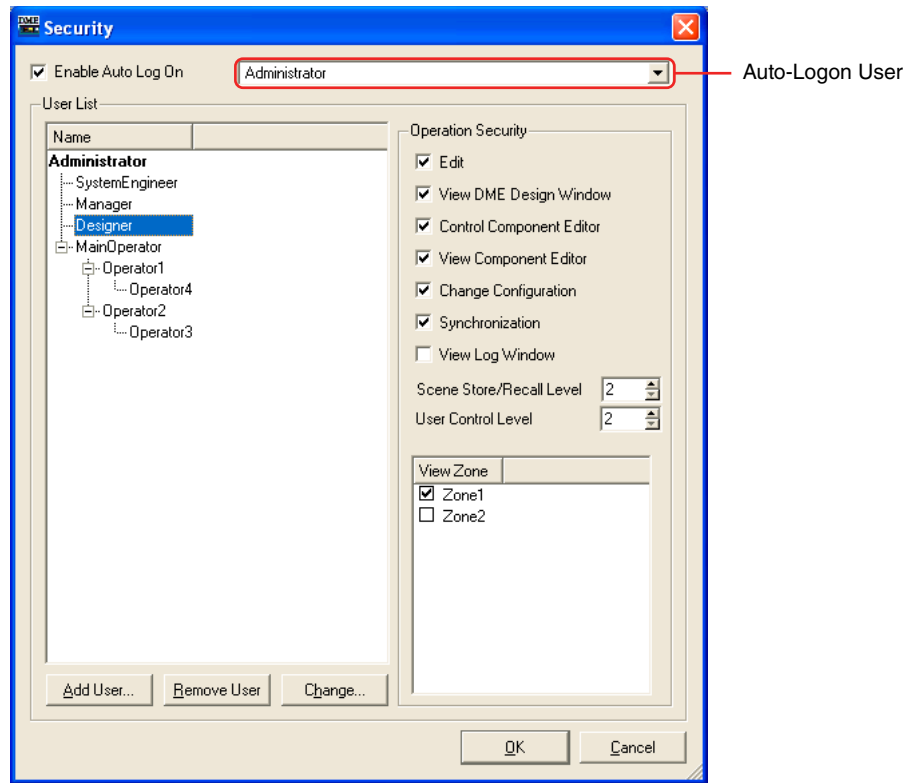

■ User Setting Restrictions

Various restrictions apply, depending on the security level of the user that is currently logged on.

- The currently logged on user can edit only users at a security level lower than his or her own.
- The currently logged on user cannot raise his or her own security level.

■ [Administrator] User

The [Administrator] user is registered by default, and can use all functions. Immediately after DME Designer is installed, there is no password set for the [Administrator] user.

■ Security Level

User security levels are set with the [Operation Security] item at the right of the “Security” dialog box.

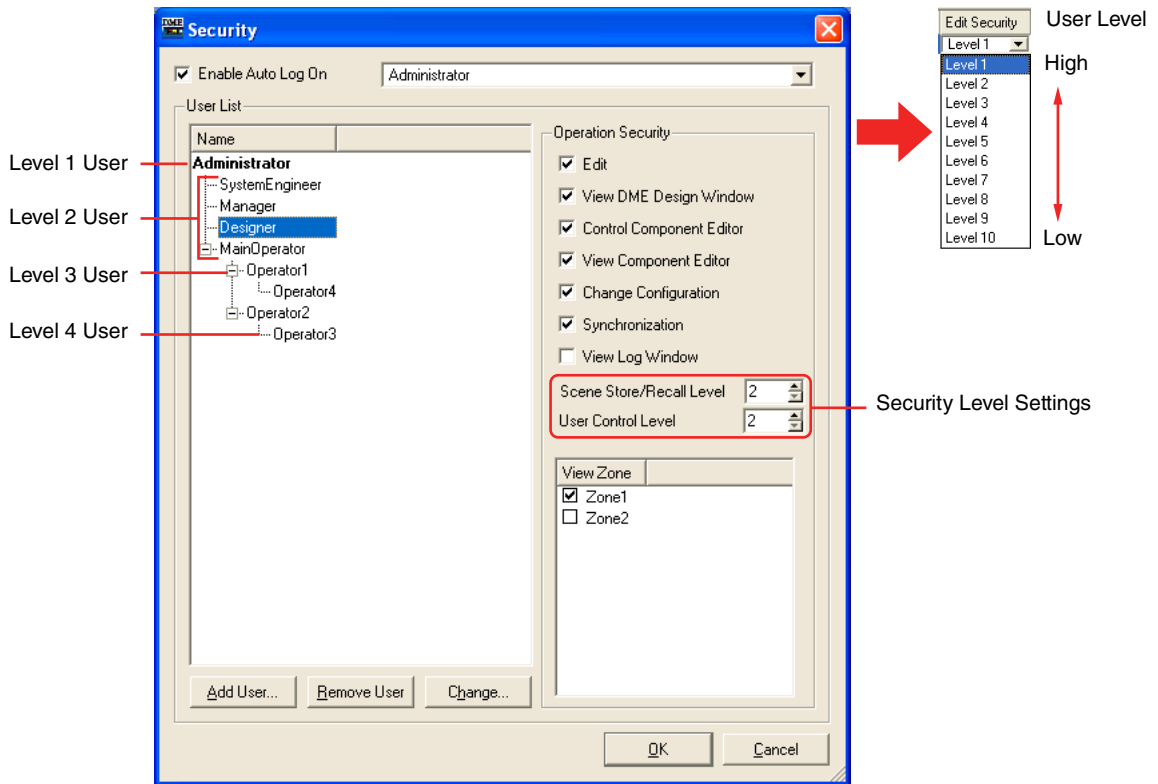

You can allow or disallow editing and the ability to open windows or set controls. Ten levels, 1 through 10, are set for scene storage/recall and user controls. Level 1 is the highest level and 10 is the lowest. By default, level 1 is set for the [Administrator] user. Level 1 can be set for the [Administrator] only. Users created by the [Administrator] directly below itself can be set at levels 2 through 10. New users created subordinate to users at level 2 can be set at levels 3 through 10. New users can be created no higher than one level below the user that created them. Scene sets the level for storing and recalling scenes. The logged on user can store or recall scenes at levels equal to or lower than his or her own level. For example, a user at level 3 can recall scenes set for scene recall at levels 3 through 10. Levels are also set for user control. The logged on user can display or edit user controls at levels equal to or lower than his or her own level. The log-on user can use zones that are checked in the [View Zone] field. Users with security level lower than level 2 form groups with a level-2 user as the leader. Regardless of user security level, user controls and scenes created by users of a different group cannot be used or edited.

Names and Functions

[Enable Auto-Log On]

Enables auto-logout. If this checkbox is selected, the user displayed in the box to the right will be logged on automatically when DME Designer is started. Auto-logout logs on the user without any password entry.

Click the [▼] at the right of the box, and select the user for auto-logout from the displayed user list. If auto-logout is turned OFF, the “Log On” dialog box will be displayed whenever the DME Designer is started. Each time a user must be selected and a password entered in order to log on. If auto-logout is changed from ON to OFF, “Confirmation of Current User” dialog box will be displayed.

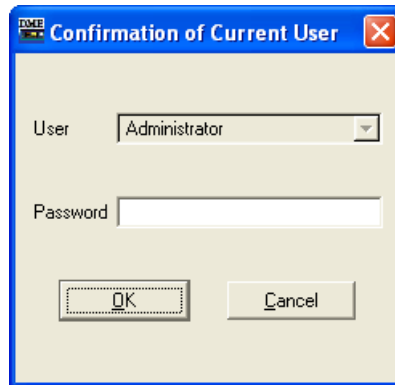

Enter the user's password into the [Password] box, and click the [OK] button. If you click the [Cancel] button, auto-logout will remain ON.

■ Auto-Logout User

Selects the user for auto-logout when [Enable Auto Log On] is checked.

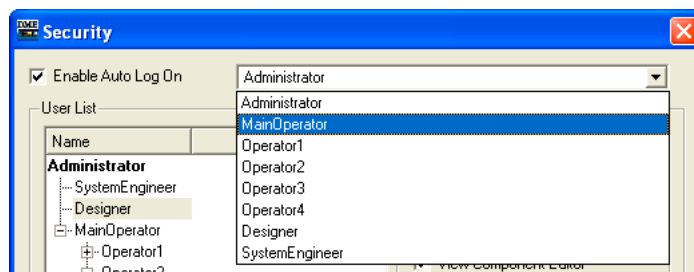

The currently logged on user can set this command for users at a security level equal to or lower than his or her own. If a user at a higher level is selected, a message that warns “Cannot access higher user level.” will be displayed. Click the [OK] button.

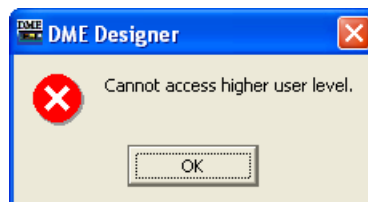

To set auto-logout for a user at a security level higher than the currently logged on user, first log off as the current user, then log on as a user at a higher security level.

User List

The registered users are displayed here. The currently logged on user is displayed in bold text. Click the name of the user whose settings you want to edit.

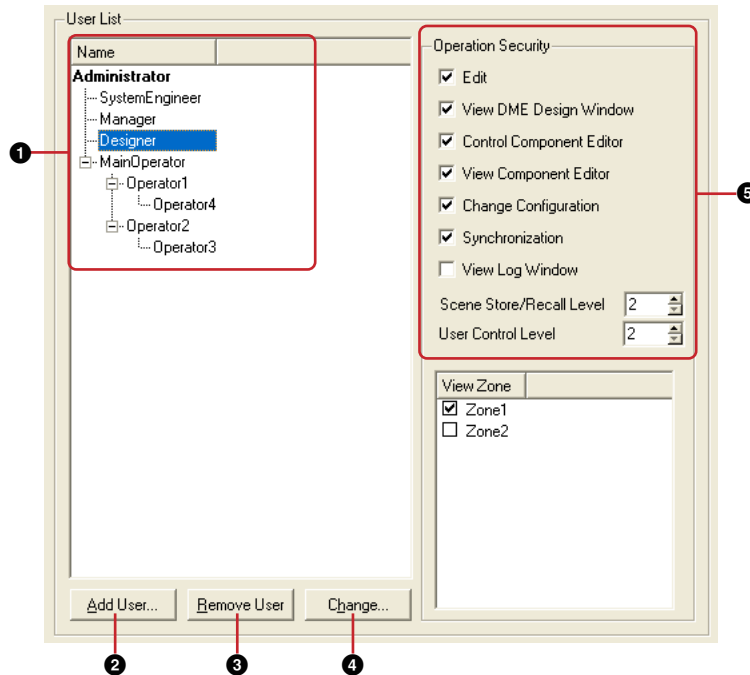

The [Administrator] is the user set by default, and it is used for administering the system. The [Administrator] user has the highest level and can use all functions.

All new users are created at a level lower than the [Administrator] user, and are displayed below the [Administrator].

If a user at level 2 and below has other users subordinate to him or her, a [+] or [-] button will be displayed to the left of higher level user's name on the list. Clicking the [+] or [-] buttons displays or hides the users subordinate to that higher user.

The currently logged on user can create multiple users at lower levels.

1 Name

Displays the user names. The currently logged on user is displayed in bold text.

2 [Add User] Button

Adds a user subordinate to the user selected on the list. Clicking here displays the "Add User" dialog box. Select the user that will be superior to the new user, then click this button.

If a user higher than the currently logged on user is selected, the button will be grayed out and no user can be added.

3 [Remove User] Button

Deletes the user selected on the list. Only users at levels lower than the currently logged on user can be deleted.

Furthermore, the currently logged on user cannot delete himself.

4 [Change] Button

Changes settings for the user selected on the list. Opens the "Change User Information" dialog box. The contents of the dialog box are the same as the "Add User" dialog box.

5 Operation Security

Sets the functions that can be used by the user selected on the [User List] to the left. Selecting a checkbox enables use of the corresponding function.

- **[Edit]**
You can change the following settings: editing in the Designer window, user control edit, user defined parameter edit, word clock, scene edit, GPI and MIDI.
- **[View DME Design Window]**
Allows display of the Designer window.
- **[Control Component Editor]**
Allows parameter editing in the component editor.
- **[View Component Editor]**
Allows display of the component editor.
- **[Change Configuration]**
Allows switching between configurations.
- **[Synchronization]**
Allows synchronizing with the DME or SP2060 unit.
- **[View Log Window]**
Displays the “Event Logger” window.
- **[Scene Store/Recall Level]**
Sets the level at which scenes can be stored and recalled. Click the [▲] and [▼] buttons or enter a number into the box to set the level. While levels 1 through 10 are available, the range of levels that can be actually set varies according to the level of the user doing the setting. When a user is created, automatically this is set to “One level lower than the user above.” The initially set level is the highest level that can be set for that user.
- **[User Control Level]**
Sets the user control level. Click the [▲] and [▼] buttons or enter a number into the box to set a level from 1 through 10. While levels 1 through 10 are available, the range of levels that can be actually set varies according to the level of the user doing the setting. When a user is created, automatically this is set to “One level lower than the user above.” The initially set level is the highest level that can be set for that user.

[OK] Button

Applies any setting changes and closes the window.

[Cancel] Button

Closes the window without changing any settings.

“Add User” Dialog Box/“Change User Information” Dialog Box

When you click the [Add User] button in the “Security” dialog box, the “Add User” dialog box is displayed. If you click the [Change] button in the “Security” dialog box, the “Change User Information” dialog box is displayed.

The “Add User” dialog box is for setting a user name and password when adding a new user. You can change user settings in the “Change User Information” dialog box. The contents of the dialog boxes are the same.



“Add User” dialog box

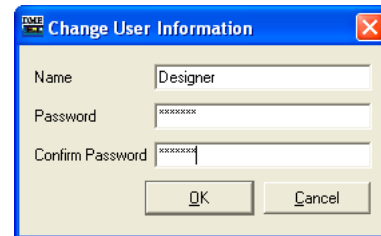

“Change User Information” dialog box

■ [Name] Box

Enter the user name. Enter a name different than other existing user names.

■ [Password] Box

Enter the password. When you type in the password box, asterisks (*) will be displayed instead of the characters you enter. If you do not want to set a password the user, leave the box blank.

■ [Confirm Password] Box

Enter the password once again to confirm it. When you type in the password box, asterisks (*) will be displayed instead of the characters you enter. If you do not want to set a password the user, leave the box blank.

■ [OK] Button

In the “Add User” dialog box, this creates new users according to the settings made there. In the “Change User Information” dialog box, this applies the dialog box settings and changes the user settings.

■ [Cancel] Button

Cancels user creation or setting changes, and closes the dialog box.

Creating Users

Users are created as follows:

1 Click [Security] on the Main Panel window [Setup] menu.

The “Security” dialog box will be displayed.

You can open the “Security” dialog box by clicking the [Security] button in the Main Panel window.

2 Select a user from the [User List] in the “Security” dialog box.

A user will be created subordinate to the selected user. [Administrator] can be selected only if the logged on user is the [Administrator]. If there are multiple users, select the user that will be above the new user.

Multiple users can be created subordinate to a single user.

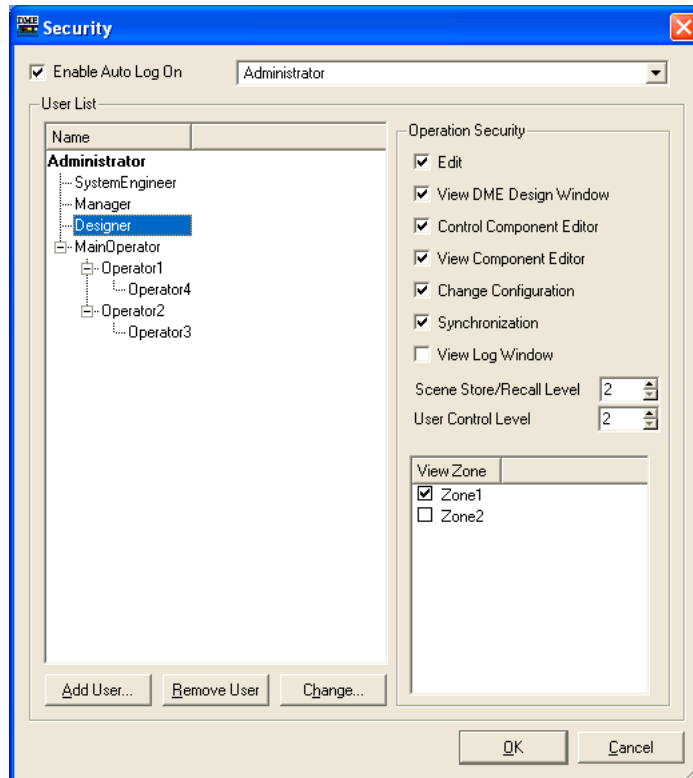

3 Click the [Add User] button.

The “Add User” dialog box will be displayed.

4 Enter the user name into the [Name] box.

5 Enter the password into the [Password] box.

You can also create users with no password. If you do not want to set a password for the user, leave the [Password] box blank.

6 Enter the password into the [Confirm Password] box also.

If you do not want to set a password for the user, leave the [Confirm Password] box blank also.



NOTE

If the text entered into the [Password] and [Confirm Password] boxes is not the same, a "Different password!" message will be displayed. Click the [OK] button and reenter the correct password in the [Password] and [Confirm Password] boxes in the "Add User" dialog box.



7 Click the [OK] button.

This closes the "Add User" dialog box. The new user will be added to the "Security" dialog box list.

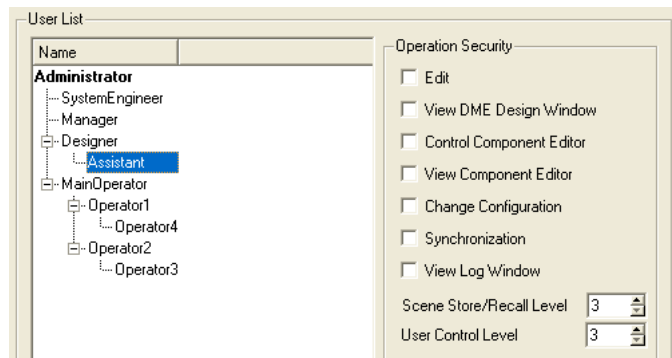

8 Set the security level for the user, using [Operation Security] in the "Security" dialog box.

When creating a new user, all the checkboxes in [Operation Security] will be turned OFF. Click and turn ON the functions you want to permit the new user to use. [Scene Store/Recall Level] and [User Control Level] will be set to one level lower than the user above the newly created user. The initially set level will automatically be the highest level that can be set for that user. To lower the level, enter a larger number in the box.

Click the [OK] button and the dialog will close. You can continue creating new users without closing the dialog box.

Network Setup

Click the [Network Setup] item in the [Hardware] menu to open the “Network Setup” window. This window can be used to set the IP address and device group master/slave status of DME and SP2060 units.

NOTE

These settings can be edited regardless of the current settings of the DME and SP2060 units. The DME Utility screen Lock page and SP2060 Utility screen User Lock settings only apply to the device panels.

NOTE

DME64N/24N and SP2060 slave devices will not be displayed.

NOTE

The settings cannot be changed for devices in a device group that is online.

“Network Setup” Window

Names and Functions

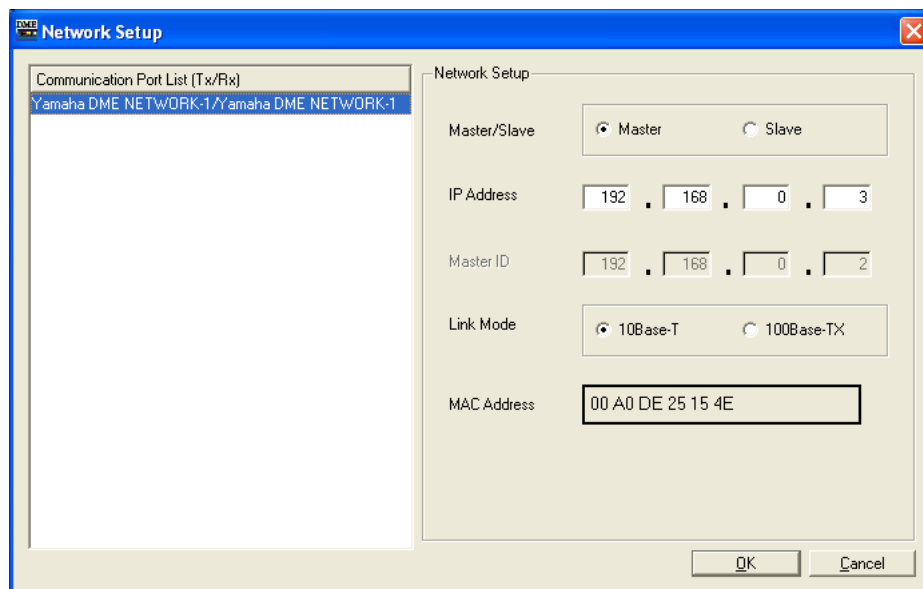

■ Communication Port List (Tx/Rx)

Selects the communication port for the device to be set up.

■ Master/Slave

Displays and sets whether the DME or SP2060 unit connected to the port specified by the “Communication Port” dialog box is the device group master or slave.

■ IP Address

Displays and sets the IP address of the DME or SP2060 unit connected to the port specified by the “Communication Port” dialog box.

NOTE

If the IP address of the DME device is changed after the device has been synchronized with DME Designer, it will be necessary to re-transfer the configuration data. The “Full Resync” operation forces a re-transfer of all configuration data, and can be initiated by clicking the [Go On-line] button while holding down the [Ctrl] key.

NOTE

If the device group master IP address is changed and you are using the DME-N Network Driver, quit the DME Designer and then restart it after changing the DME-N Network Driver settings.

NOTE

The subnet mask is fixed at “255.255.255.0”.

NOTE

Always use a local address (192.168.0.2 through 192.168.255.253) unless it is absolutely necessary to use a global address. Consult with the network administrator if it is necessary to use a global address.

■ Master ID

If the DME or SP2060 unit connected to the port specified by the “Communication Port” dialog box is a slave device, the fourth octet of the of the device group master IP address is displayed and can be edited here. This parameter is display only if the device is the device group master.

NOTE

Be sure to set the DME and SP2060 to a different device group.

■ Link Mode

Displays and sets the link mode of the DME or SP2060 unit connected to the port specified by the “Communication Port” dialog box.

■ MAC Address

Displays the MAC address of the DME or SP2060 unit connected to the port specified by the “Communication Port” dialog box.

Utility

Click the [Utility] item of the [Hardware] menu to open the “Utility” window.

“Utility” Window

This window provides a variety of utility settings for DME and SP2060 units. These settings can be made when the target unit is not only online but also offline. A password will be required to open this window if the DME64N/24N Utility screen is locked.

NOTE

Only users with security status in which [Edit] is checked can edit Utility parameters.

Names and Functions

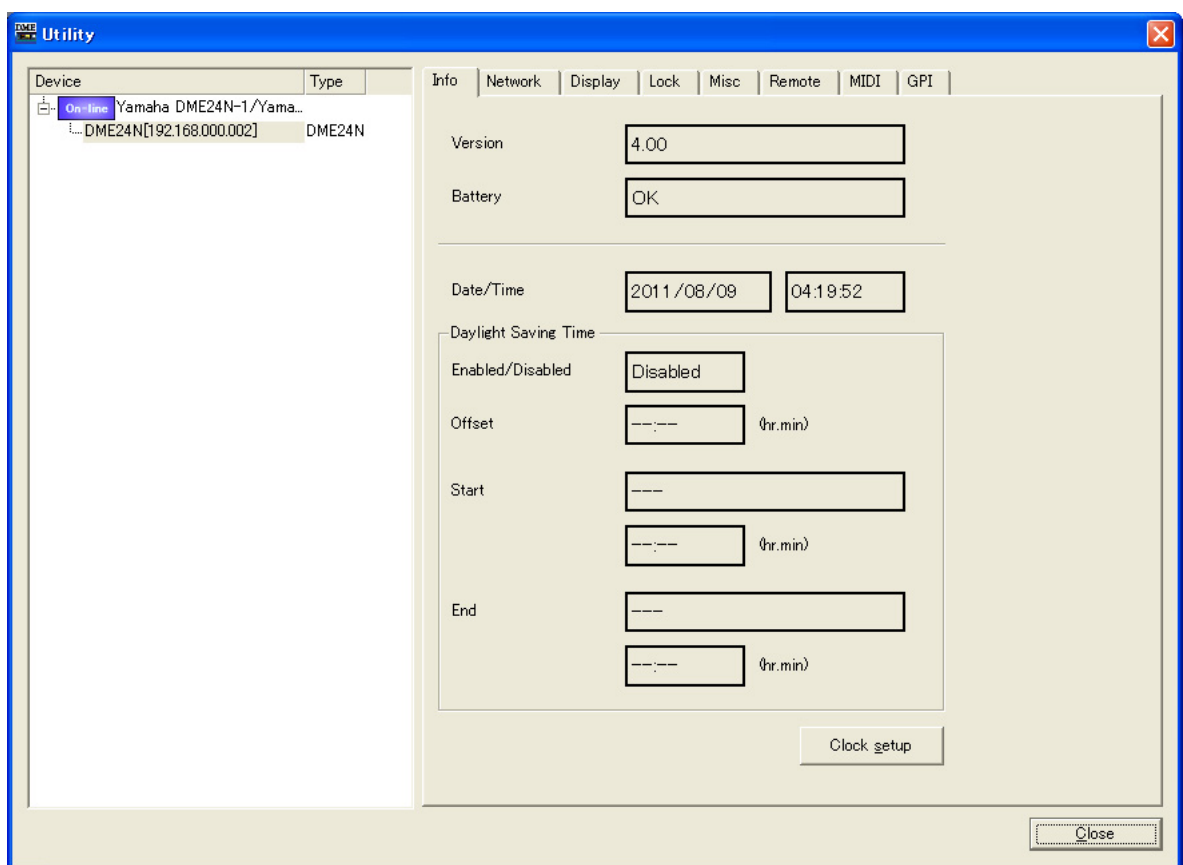

■ Device Select Field (Device/Type Field)

Select the DME or SP2060 to be displayed or edited from the list.

■ [Close] Button

Closes the window.

■ Info Tab

The screenshot shows the 'Info' tab of the DME Designer software. The interface is organized into several sections:

- Version:** A text box containing the value '4.00'.
- Battery:** A text box containing the value 'OK'.
- Date/Time:** Two text boxes showing the date '2011/08/09' and the time '04:19:52'.
- Daylight Saving Time:** A section containing:
 - Enabled/Disabled:** A dropdown menu set to 'Disabled'.
 - Offset:** A text box with '---:--' and '(hr.min)' next to it.
 - Start:** A text box with '---:--' and '(hr.min)' next to it.
 - End:** A text box with '---:--' and '(hr.min)' next to it.
- Buttons:** A 'Clock setup' button is located at the bottom right of the form.

Displays basic information for the selected DME or SP2060 unit.

Version

Displays the firmware version number of DME or SP2060 unit.

Battery

Displays the battery status of DME or SP2060 unit.

Date/Time

Displays the date and time of the DME internal clock.

Daylight Saving Time

Displays the daylight saving time settings.

[Clock setup] Button

Opens the "Clock" dialog box to set the DME internal clock.

→ See "Clock" on [page 180](#).

■ Network Tab

Info	Network	Display	Lock	Misc	Remote	MIDI	GPI
Master/Slave	Master						
Link Mode	100Base-TX						
MAC Address	00 A0 DE 25 02 00						

Displays DME and SP2060 network information.

Master/Slave

Displays the device group master and slave.

Link Mode

Displays whether the network connection is via 10Base-T or 100Base-TX.

MAC Address

Displays the MAC address.

■ Display Tab

Info	Network	Display	Lock	Misc	Remote	MIDI	GPI
LCD Contrast	55 %						
LCD BackLight	<input checked="" type="radio"/> ON <input type="radio"/> OFF						
Meter Fall Time	<input checked="" type="radio"/> Slow <input type="radio"/> Fast						

Displays and allows editing of the DME64N/24N panel display.

LCD Contrast

Displays and sets the display contrast. The parameter range is 0 ... 100%.

LCD Backlight

Displays and sets the display backlight status. The settings are "ON" or "OFF".

ON: The display backlight is continuously on.

OFF: The display will light when a panel control is operated, but will go out 10 seconds after panel operation stops.

Meter Fall Time

Displays and sets the meter fall time. The settings are "Slow" and "Fast".

Slow: Slow meter fall time.

Fast: Fast meter fall time.

■ Lock Tab

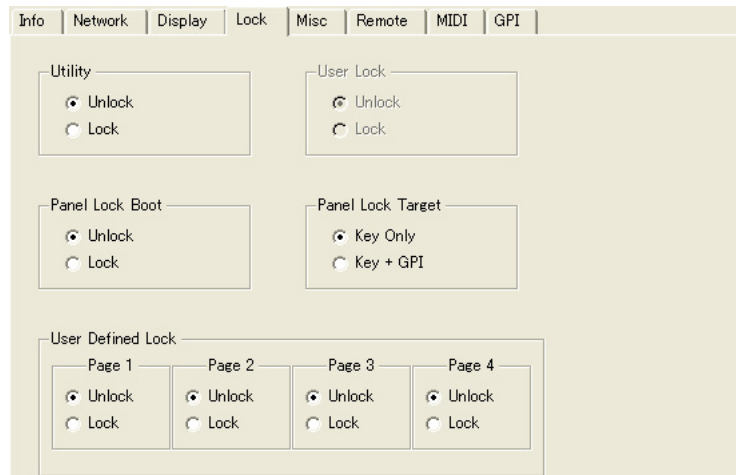

Displays and allows editing of the DME64N/24N and SP2060 panel lock parameters. Only the User Lock parameter is displayed and can be edited for SP2060 units. All other parameters are displayed and can be edited for DME64N/24N units.

Utility

Displays and sets the Utility screen lock status. The settings are “Unlock” and “Lock”.

Unlock: The Utility screen can be opened without a password.

Lock: An 8-character password is required to open the Utility screen.

NOTE

The password is also required to switch from “Unlock” to “Lock” status.

Panel Lock Boot

Displays and determines whether the panel lock will be automatically engaged when the unit is turned on. The settings are “Unlock” and “Lock”.

Unlock: The panel will not be locked when power to the unit is turned on.

Lock: The panel will be locked when power to the unit is turned on.

Panel Lock Target

Displays and sets the panel lock target. The settings are “Key Only” and “Key+GPI”.

Key Only: Only input via the panel controls will be locked.

Key+GPI: Input via the panel controls and GPI inputs will be locked.

User Defined Page Lock

Displays and sets the User Defined Button lock status for each page. The settings are “Unlock” and “Lock”.

Unlock: The corresponding User Defined Button page will be displayed.

Lock: The corresponding User Defined Button page will not be displayed.

User Lock

Displays and sets the panel lock status. The settings are “Unlock” and “Lock”.

Unlock: Panel not locked.

Lock: Panel locked.

The following operations cannot be performed when the panel is locked:

- Parameter changes.
- Scene recall/store.
- Scene title editing.
- Scene protect changes.
- Library recall.

■ Misc Tab

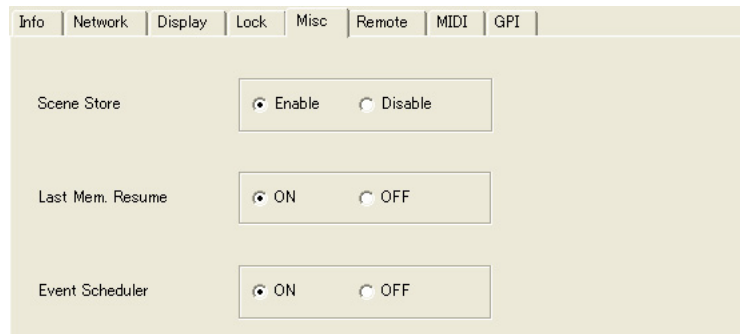

Displays and sets parameters not provided in the other tabs.

Scene Store

Displays and sets whether scene store operations can be performed on a DME64N/24N unit. The settings are “Enable” and “Disable”.

Enable: Scene store possible.

Disable: Scene store not possible.

Last Mem. Resume

Determines whether the scene number that was selected when the power was last turned off will be recalled when the power is turned on, or whether the overall status of the unit when the power was last turned off will be recalled when the power is turned on. The settings are “ON” and “OFF”.

ON: The status of the unit when the power was last turned off will be recalled.

OFF: The scene number that was selected when the unit was last turned off will be recalled.

Event Scheduler

Displays and sets whether the DME unit's Event Scheduler function is active or not. The settings are “ON” and “OFF”.

ON: The Event Scheduler is active.

OFF: The Event Scheduler is not active.

■ Remote Tab

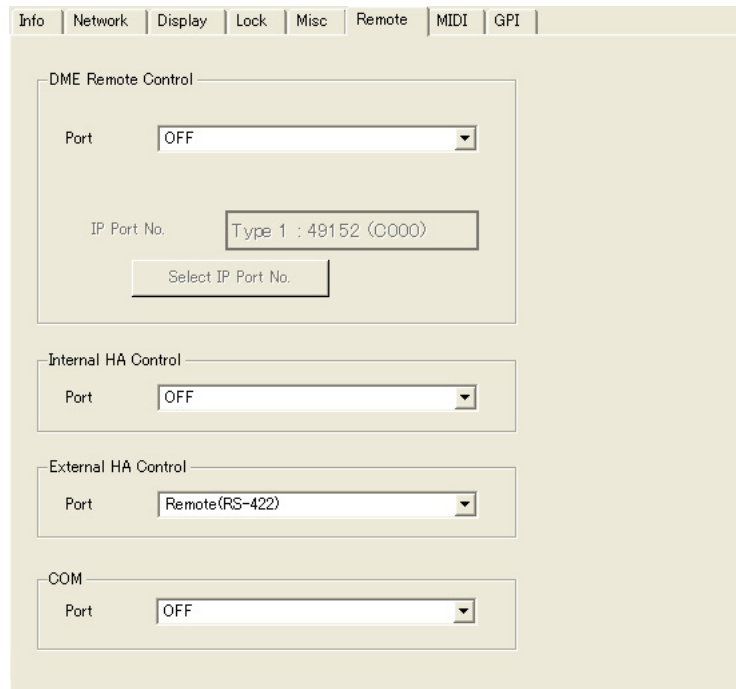

NOTE

The SP2060 and ICP1 are not supported.

DME Remote Control

Displays/sets the connector and connection type to be used for DME remote control protocol* communication. If the selected terminal was previously assigned to a different function, a confirmation message will appear. The available ports depend on the device.

DME64N/DME24N: OFF, Remote (RS-232C), Remote (RS-422), Network

DME Satellite: OFF, Remote, Network

OFF: Select “OFF” when this function is not to be used.

Remote (RS-232C): External controllers (AMX, Crestron, etc.) control the DME64N/24N via the [REMOTE] connector using an RS-232C connection.

Remote (RS-422): External controllers (AMX, Crestron, etc.) control the DME64N/24N via the [REMOTE] connector using an RS-422 connection.

Network: This setting allows the DME to be controlled via the [NETWORK] terminal. When “Network” is selected it is also possible to select the port number to be used. The Ethernet port to be used for remote control will be displayed in the “IP Port No.” field. Change the port as necessary via the “Select IP Port No.” dialog box that appears when the [Select IP Port No.] button is clicked.

Since the DME network connection will automatically be broken when the port is changed, DME Designer will have to be re-launched.

Remote: External controllers (AMX, Crestron, etc.) control the DME Satellite via the [REMOTE] connector connection.

NOTE

Switch the [REMOTE] terminal setting (RS-232C, RS-422) via the DIP switch on the rear panel of the DME Satellite.

* Refer to “DME Remote Control Protocol Specifications” Yamaha Pro Audio website:
(<http://www.yamahaproaudio.com/>)

Internal HA Control

Displays/sets the connector to be used for internal head amp control. From a single digital mixer, you can control the internal head amps of multiple DME series units within the device group. Set this parameter only on the DME series units that is connected directly to the digital mixer, and turn in "OFF" for other units. If the selected terminal was previously assigned to a different function, a confirmation dialog will appear.

The available ports depend on the device.

DME64N: OFF, Remote (RS-422), Slot 1 through 4

DME24N: OFF, Remote (RS-422), Slot1

DME8i-C/DME8o-C/DME4io-C: OFF, Remote, CobraNet

DME8i-ES/DME8o-ES/DME4io-ES: OFF, Remote, EtherSound

OFF: Select "OFF" when this function is not to be used.

Remote (RS-422): Allows a digital mixer to control the DME64N/24N's internal head amps via the [REMOTE] connector using an RS-422 connection.

Slot1–Slot4: Allows a digital mixer to control the internal head amps via the specified expansion slot.

Remote: Allows a digital mixer to control the DME Satellite's internal head amps via the [REMOTE] connector connection.

CobraNet: Allows a digital mixer to control the DME8i-C/DME8o-C/DME4io-C's internal head amps via the [CobraNet] connector connection.

EtherSound: Allows a digital mixer to control the DME8i-ES/DME8o-ES/DME4io-ES's internal head amps via the [EtherSound] connector connection.

NOTE

An ID must be assigned to the DME unit to be controlled. Refer to "Setting the Internal Head Amp ID " ([page 146](#)) for details on assigning device IDs.

NOTE

Change to RS422 via the rear-panel DIP switches to select "Remote" for a DME Satellite unit.

External HA Control

Displays/sets the type of connection to be used for external head amp control. If the selected terminal was previously assigned to a different function, a confirmation dialog will appear.

The available ports depend on the device.

DME64N/DME24N: OFF, Remote (RS-422)

DME Satellite: OFF, Remote

OFF: Select "OFF" when this function is not to be used.

Remote: Allows connection to and control of an external head amp such as the AD8HR. Always use this setting when a remote head amp unit (AD8HR, AD824) is connected.

NOTE

Change to RS422 via the rear-panel DIP switches to select "Remote" for a DME Satellite unit.

COM

Displays/sets the type of connection to be used for DME protocol communication. This is a Yamaha maintenance function. Normally, set this to "OFF"

■ MIDI Tab

The screenshot shows the MIDI Tab interface with the following settings:

- MIDI Control:**
 - Port: MIDI
 - Protocol: MIDI (selected), DAW(Type1), DAW(Type2)
- MIDI Channel:**
 - Tx: 1
 - Rx: 1
- MIDI Control Settings:**

	Tx	Rc	OMNI	Echo
Program Change	ON	ON	OFF	OFF
Control Change	ON	ON	OFF	OFF
Parameter Change	ON	ON		OFF

Port

Selects the MIDI port to be used. If the selected terminal was previously assigned to a different function, a confirmation dialog will appear. The available ports depend on the device.

DME64N: OFF, Remote(RS-232C), Remote(RS-422), MIDI, USB-1–2, Slot1–4

DME24N: OFF, Remote(RS-232C), Remote(RS-422), MIDI, USB-1–2, Slot1

DME Satellite: OFF, Remote, USB-2

OFF: Select “OFF” when this function is not to be used.

Remote(232C): MIDI data will be received via the DME64N/24’s [REMOTE] connector using an RS-232C connection.

Remote(422): MIDI data will be received via the DME64N/24’s [REMOTE] connector using an RS-422 connection.

MIDI: The MIDI connector is the currently active MIDI port.

USB-1, USB-2: The corresponding USB port is selected for MIDI input.

Slot1–Slot4: A card installed in the corresponding I/O slot is currently selected for MIDI input.

Remote: The [REMOTE] connector of the DME Satellite is currently active MIDI port.

NOTE

When “Remote” is selected for a DME Satellite unit, be sure to change the [REMOTE] connector setting (RS-232C or RS422) via the rear-panel DIP switches.

Protocol

Displays/sets the protocol to be used for communication with devices connected via MIDI. The available settings are: MIDI, DAW (Type1), and DAW (Type2).

MIDI: Use this setting when any MIDI device other than a general-purpose ProTools controller (HUI protocol) or general-purpose Logic or Cubase controller (Mackie control protocol) is to be connected.

DAW (Type1): Use this setting when a general purpose ProTools controller (HUI protocol) is to be connected.

DAW (Type2): Use this setting when a general purpose Logic or Cubase controller (Mackie control protocol) is to be connected.

NOTE

If the Protocol setting is changed while online, the DAW Type specified in the DAW Control dialog box will also change accordingly.

NOTE

The following parameters are available when the Protocol parameter is set to MIDI.

MIDI CH

Sets the MIDI channel. This number is also used as the Parameter Change Device ID.

- **[Tx]**
Select the MIDI transmit channel from the list.
- **[Rx]**
Select the MIDI receive channel from the list.

Program Change/Control Change/Parameter Change

Sets transmit (Tx), receive (Rx), OMNI, and Echo for program change/control change/parameter change. When ON, clicking turns this OFF. When OFF, clicking turns this ON. When OMNI is [ON] channel messages are received regardless of the receive channel setting. When ECHO is [ON] the input data is "echoed" (re-transmitted) via the output port that corresponds to the input port via which it was received.

Program change, control change, and parameter change details can be set up via the "MIDI" window [Program Change], [Control Change], and [Parameter Change] tabs, respectively.

■ GPI Tab

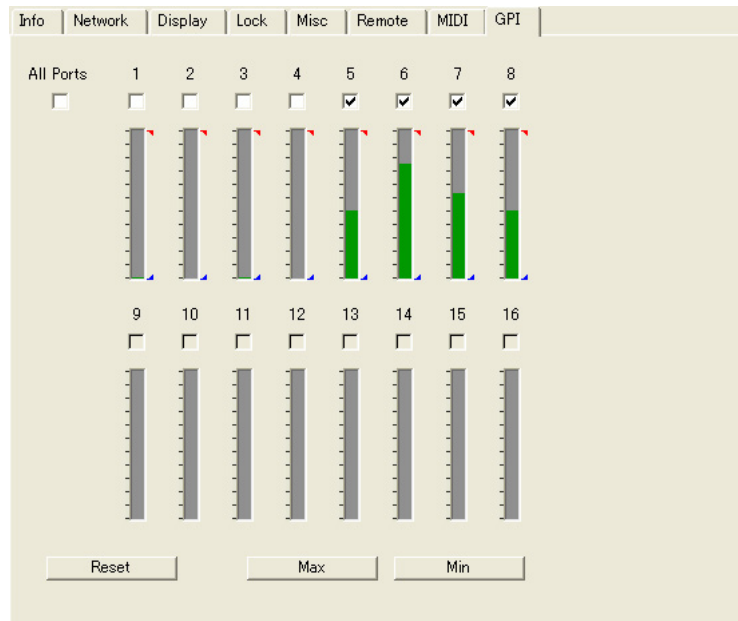

Calibrates the input voltage detection range for a DME unit GPI terminal.

[ALL] Checkbox

Automatically checks all channel checkboxes.

[Ch] Checkbox

These checkboxes specify the channels to be calibrated.

Calibration Information

Displays the input voltage in real time.

[Reset] Button

Resets the calibration of checked channels.

[Max] Button

Sets the current input voltage as the maximum input voltage for checked channels. The specified maximum voltage is indicated by a red bar.

[Min] Button

Sets the current input voltage as the minimum input voltage for checked channels. The specified minimum voltage is indicated by a blue bar.

Word Clock

The signal that synchronizes all devices connected to the DME or SP2060 is called the “Word Clock.” It uses the same frequency as the sampling frequency. The word clock is set for each DME or SP2060 in the “Word Clock” dialog box.

When you click [Word Clock] on the [Hardware] menu, the “Work Clock” dialog box is displayed.

Names and Functions

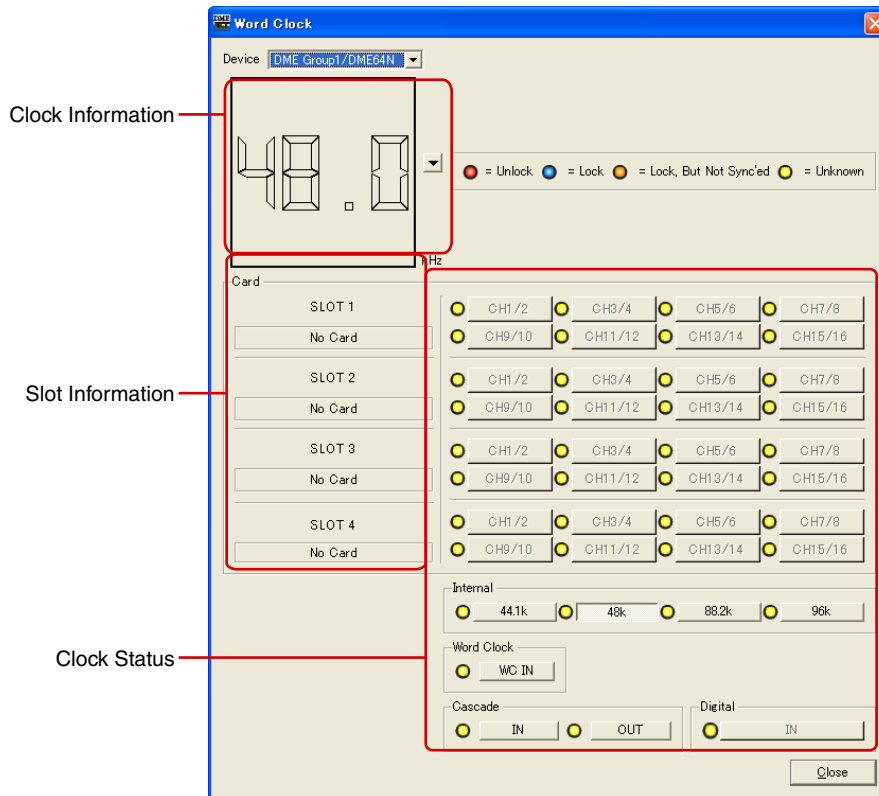

• The number of channels varies according to the card inserted into the slot.

■ DME

From the list, select the DME or SP2060 where you will be making settings.

■ Clock Information

Displays the word clock frequency for the DME or SP2060 selected in [DME].

The frequency of the operational word clock is displayed when the device is online.

When offline, the frequency information used at the time of compilation is displayed regardless of the frequency of the device’s word clock. Click the [V] button to the right of the frequency display to select the frequency of the operational word clock.



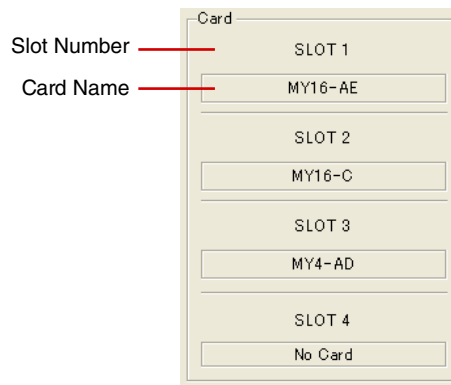

■ Card (Slot Information)

Displays the name of the card inserted into the slot.



■ Clock Status

The clock status is displayed using a color code:

Status	Meaning
 = Unlock	Indicates that there is no input signal.
 = Lock	Indicates there is an input signal and sync is possible with the current word clock.
 = Lock, But Not Sync'ed	Indicates there is an input signal but cannot sync with word clock (clocks are different).
 = Unknown	Indicates that there is no DME or SP2060 unit information.

■ Internal/Word Clock/Cascade

You can select one of the following for the word clock:

Device Name	Slot	Internal	Word Clock	Cascade	Digital
DME64N	1 ~ 4	44.1kHz/48kHz/88.2kHz/96kHz	WC IN	IN/OUT	—
DME24N	1	44.1kHz/48kHz/88.2kHz/96kHz	WC IN	—	—
DME Satellite	—	CobraNet/EtherSound: 48kHz/96kHz	—	—	—
SP2060	—	96kHz	—	—	IN(*)

* This settings can only be made when the target unit is offline and the DIGITAL IN is selected as the input signal to the SP2060 unit.

Clock buttons that are grayed out cannot be selected.

■ [Close] Button

Closes the dialog box.

NOTE

You can close the dialog box using the Close button, or by pressing <Esc> or <Alt>+<F4>.

Monitor Out

When you click the [Monitor Out] command on the [Hardware] menu, the “Monitor” dialog box is displayed. Sets the monitor output destination for monitoring point or probe monitor.

NOTE

Monitor Out can be set on DME64N/24N units only.

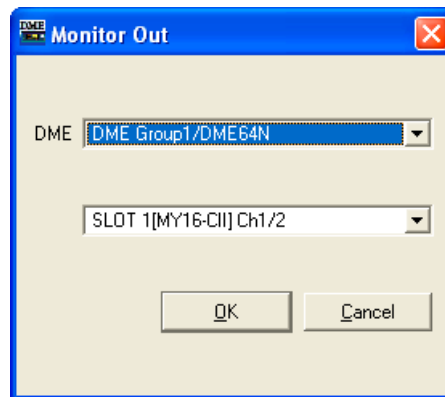
**■ [DME]**

From the list, select the DME64N/24N where you will be making settings.

■ Drop down list

From the list, select the monitor output port. You can select from the ports that are not connected in the configuration window.

■ [OK] Button

Accepts the changed settings and closes the dialog box.

■ [Cancel] Button

Closes the dialog box without changing the settings.

Clock

When you click the [Clock] command on the [Hardware] menu, the “Clock” dialog box is displayed after the “Utility” window has been displayed once. Here you can set the DME internal clock. This can be set only when online. The default is the computer date and time. The daylight saving time can also be set.

NOTE

Does not apply to SP2060 units

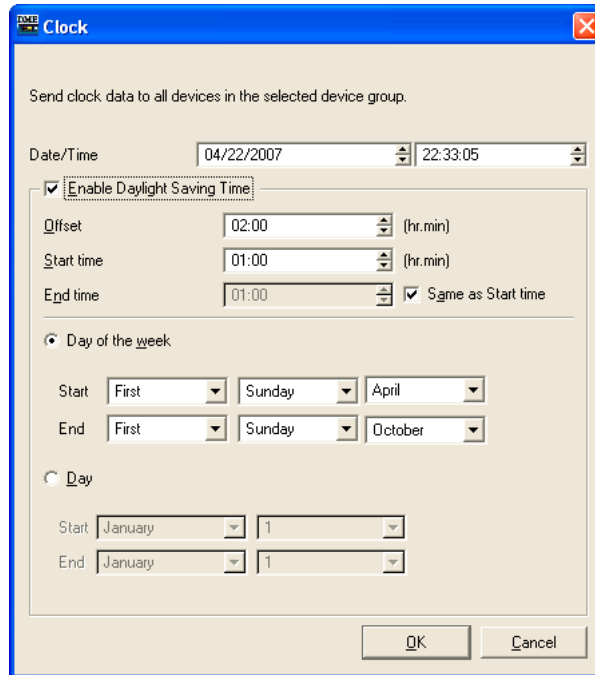

■ [Date/Time]

Sets the date via the left button and the time via the right button. Change the values via the up and down arrow buttons at the right edge of the box.

NOTE

The date and time display format can be changed via the Windows control panel “Regional and Language Options” item. This will also change the display format for the “Utility”, “Event Logger”, “Event Scheduler” and other dialog boxes.

■ [Enable Daylight Saving Time]

When this checkbox is checked daylight saving time display is enabled. The [DST] indicator will also appear in the Date field of the DME64N/24N display.

[Offset]

Sets the time offset for the daylight saving time period.

[Start Time]

Sets the time at which daylight saving time will start.

[End Time]

Sets the time at which daylight saving time will end. If the end time is the same as the start time, check [Same as Start Time].

NOTE

Time settings may not register properly if the current time or daylight savings end time is set to within 2 hours of the daylight savings start time, or if the current time or daylight savings start time is set to within 2 hours of the daylight savings end time. Also, events set within 2 hours of the daylight savings start or end times may not be executed properly.

[Day of the Week]

When checked the daylight saving time period can be specified by the day of the week. [Start] sets the start day, and [End] sets the end day as the nth Monday, Tuesday, Wednesday, Thursday, Friday, Saturday, or Sunday of the month. For example, the first Sunday of April is specified as [First] [Sunday] [April], and the last Sunday of October is specified as [Last] [Sunday] [October].

[Day]

Specifies the daylight saving time period by day. The [Start] and [End] day are specified as the day of the month.

■ [OK] Button

Applies any setting changes and closes the window.

■ [Cancel] Button

Closes the window without changing any settings.

NOTE

You can close the dialog box using the Close button, or by pressing <Esc> or <Alt>+<F4>.

Language Settings

When you click the [Language] command on the [Hardware] menu, the “Language” dialog box is displayed. This sets the language of scene names, User Defined parameter names, and labels that will be shown on the DME64N/24N unit display. This setting also applies to the names of files saved using the DME File Storage function.

NOTE

This setting does not apply to the SP2060. As for the DME Satellite, this setting only applies to the names of files saved using the DME File Storage function.

Names and Functions

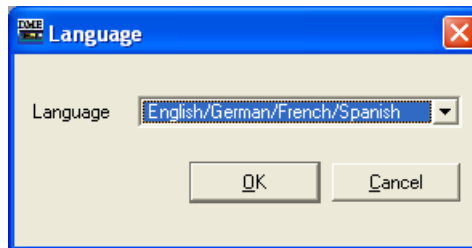

■ [Language]

Select the language. [English/German/French/Spanish] and [Japanese] are in the list.

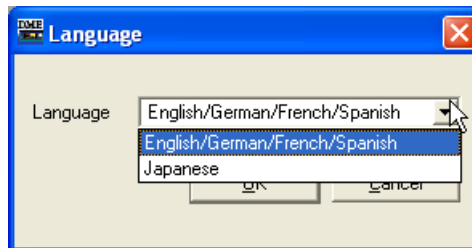

■ [OK] Button

Accepts the changed settings and closes the dialog box.

■ [Cancel] Button

Closes the dialog box without changing the settings.

NOTE

You can close the dialog box using the Close button, or by pressing <Esc> or <Alt>+<F4>.

Backup

When you click the [Backup] command on the [Hardware] menu, the “Backup” dialog box is displayed. Data in the DME or SP2060 is gathered in the computer and saved as a file. Backup files are created for each DME or SP2060. You can also send the information saved in a file to a DME or SP2060. Backup can be performed only when in offline status.

NOTE

If a backup file from a DME unit running firmware version V3.8 or later is loaded into a DME unit running a firmware version earlier than V3.5, the Remote and MIDI control settings will not apply (all other settings will apply).

NOTE

Backup operations can be performed only by users for whom the [Edit] security checkbox has been checked.

NOTE

The event log can be retrieved from the DME unit in the “Event Logger” window.

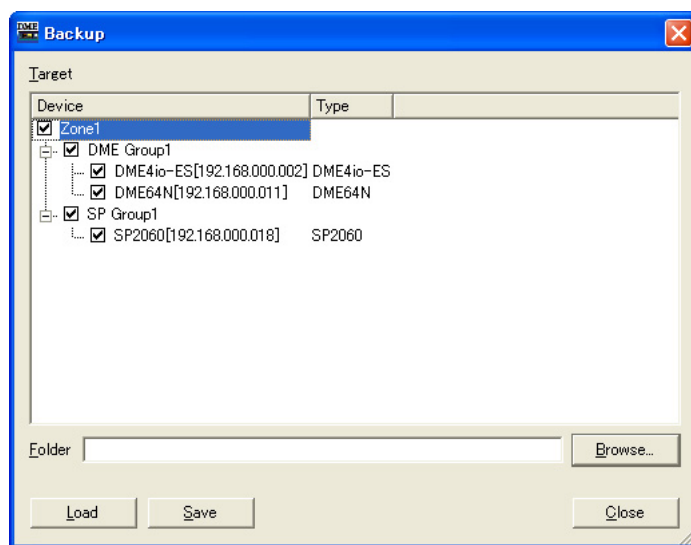

■ [Target DME]

The DME and SP2060 IP addresses and types are displayed for each device group. Check the DME and/or SP2060 units from which data is to be obtained. Multiple DME and SP2060 units can be checked.

■ [Folder] Box

Specifies the folder that will be the destination for saving and reading operations. Clicking the [Browse] button opens the folder select dialog box, where you can specify a folder. The backup file name will be the DME's IP address. If the folder is specified when sending DME data, the file sent to the DME will be the file in the folder whose file name that matches the DME's IP address.

■ [Load] Button

Sends the backed up file to the specified DME or SP2060.

■ [Save] Button

Obtains data from the specified DME or SP2060, and saves it as a backup file.

■ [Close] Button

Closes the dialog box.

SP2060 Backup

Click [SP2060 Backup] in the [Hardware] menu to open the “SP2060 Backup” dialog box. Internal SP2060 data can be transferred to a computer for backup, and the backup data can be used to restore multiple SP2060 units. This makes it possible to set up a single SP2060 unit, and then distribute the settings to a group of SP2060 units.

Backup can also be carried out using the “Backup” dialog box, but the “SP2060 Backup” dialog box has the following differences:

- “SP2060 Backup” can only be used for SP2060 backup.
- Data from only one SP2060 can be backed up at a time, but that data can be used to simultaneously restore multiple SP2060 units.
- Network settings are not affected when the data is restored.

NOTE

- Backup files cannot be edited using DME Designer.
- Backup/restore can only be carried out while offline.
- Only users for whom [Edit] security is checked (enabled) can perform backup and restore operations.
- If backup data is restored to an SP2060 unit running a firmware version prior to V1.3, the network settings will be changed.

■ [Backup] Tab

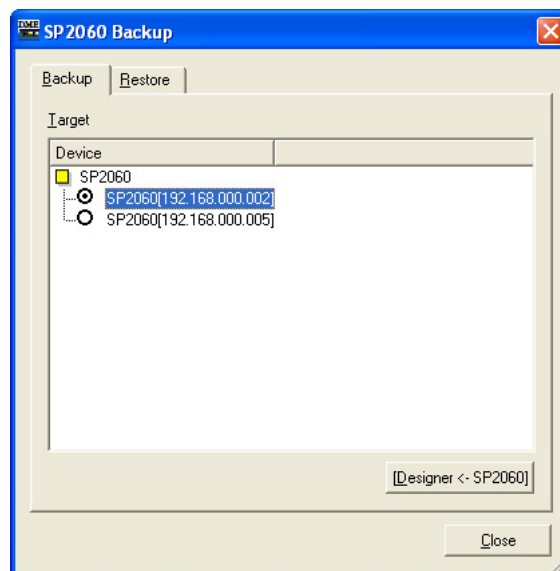

Target

Displays the label and IP address of connected SP2060 units that are offline. One SP2060 unit can be selected for backup.

[Designer <- SP2060] Button

The data is acquired from the specified SP2060 unit and saved as an SP2060 backup file (file extension “.spb”).

■ [Restore] Tab

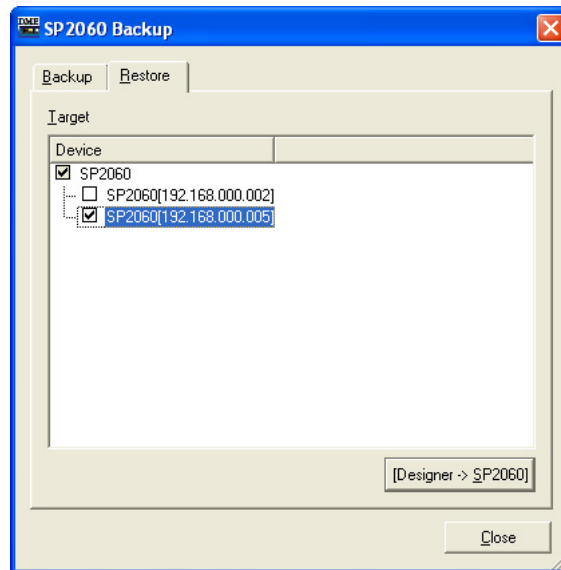

Target

Displays the label and IP address of connected SP2060 units that are offline. Check the SP2060 units to which the data is to be restored. Multiple SP2060 units can be selected.

[Designer -> SP2060] Button

Transmits and restores the SP2060 backup file (file extension “.spb”) to the specified SP2060 unit. Backup files with the “.dbk” file extension stored in the “Backup” dialog box cannot be selected. When the restore operation is finished the SP2060 unit will automatically restart. At this time please also manually restart DME Designer.

DME Firmware Update

You can update the DME or SP2060 unit, ICP1 firmware using the [Firmware Update] command on the [Hardware] menu. When you move the mouse cursor over the [Firmware Update] command on the [Hardware] menu, a submenu is displayed.

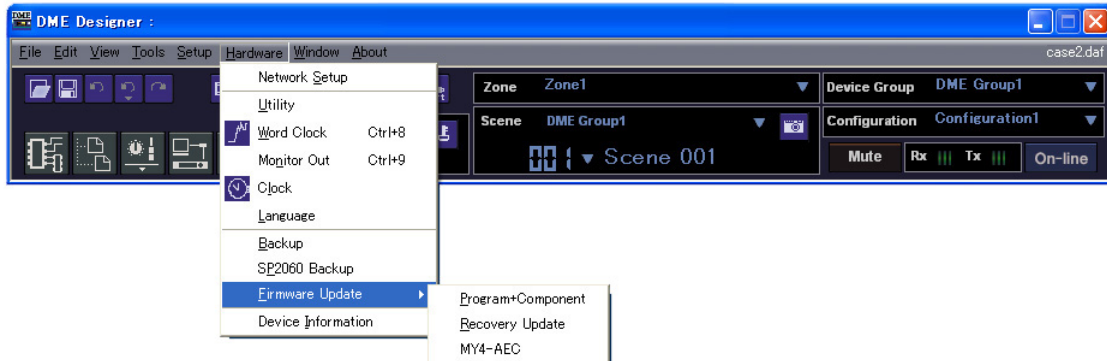

When you select [Program+Component] or [Recovery Update] on the submenu, the folder select dialog box will be displayed.

When performing a firmware update, connect the DME or SP2060 unit, ICP1 and the computer.

When the DME or SP2060 unit, ICP1 update is finished, the DME or SP2060 unit, ICP1 will be automatically restarted. You also need to restart DME Designer.

NOTE

When performing the DME or SP2060 unit firmware update, connect the DME or SP2060 unit and the computer by USB or Ethernet. The USB-MIDI or DME-N Network Driver must be installed in the computer.

NOTE

To perform the ICP1 firmware update, the ICP1 and the device group master DME unit must be connected by Ethernet. In addition, the device group master DME unit must be connected to the computer as described above.

NOTE

If the DME64N/24N has been updated from V1.07 or earlier to V1.10 or later, perform the update twice. Because the text display data in the DME64N/24N unit is changed, text display for Japanese is not possible with one update only.

NOTE

It may be impossible to complete the firmware update, and "Error" may occur in the Status field if the [Remaining Memory] value (the amount of remaining DME memory) (page 111) becomes too small. If this occurs, delete unwanted data such as DME File Storage files, Library data, and scene data to increase the amount of available memory.

NOTE

You can download the latest firmware from the following Yamaha Pro Audio website.
<http://www.yamahaproaudio.com/>

■ [Program+Component]

Updates the DME/SP2060/ICP1 unit firmware.

NOTE

DME Designer cannot be used to upgrade firmware version 3.5 or earlier to version 3.8 or later, or to downgrade from version 3.8 or later to version 3.5 or earlier (this does not apply to the SP2060 or ICP1). Contact your Yamaha dealer.

1 Select [Firmware Update] → [Program+Component] in the [Hardware] menu.

The folder select dialog box will be displayed.

2 Select the folder that contains the update file, then click the [OK] button.

The “Firmware Update” window will open. The names, firmware version numbers and IP addresses of DME, SP2060 and ICP1 units in the current device group will be displayed in a list.

NOTE

All connected DME units are displayed in the Device field.

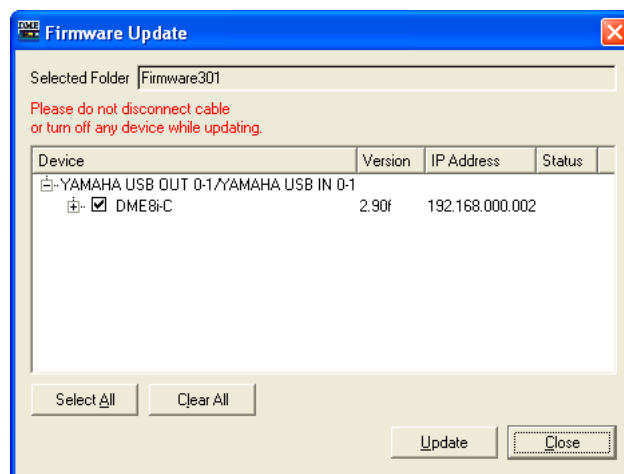

3 Check the DME, SP2060, or ICP1 unit you wish to update.

Clicking the checkboxes alternately turns the check mark on and off. The [Select All] button can be used to check all DME, SP2060, and ICP1 units. The [Clear All] button removes the check marks from all DME, SP2060, and ICP1 units.

4 When the DME, SP2060, and ICP1 units to be restored have been checked, click the [Update] button.

The firmware update will begin.

When the restore update is complete the DME, SP2060, and ICP1 units will restart automatically. It is also necessary to restart the DME designer.

NOTE

If a cable is disconnected or the power is interrupted during a firmware update operation, it may not be possible to restart the unit after the update has finished and the conditions listed below may occur. If this happens it will be necessary to carry out the Recovery Update procedure described below.

- “Recovery Update” appears on the DME64N/24N and/or ICP1 display.
- The DME Satellite “ERROR” indicator lights and the channel 2 PEAK indicator flashes.
- “Download Mode” appears on the SP2060 display.

■ [Recovery Update]

Recovers (restores) the DME, SP2060, or ICP1 firmware. If a cable is unplugged or the power is cut off during a firmware update, the firmware may be corrupted and unable to launch. In such cases the Recovery Update function can restore the firmware.

- 1 Disconnect the device which is to undergo the Recovery Update procedure from the network, and connect it directly to the computer. Restart the firmware.
- 2 Launch DME Designer and make the necessary communication port settings. (Page 155)
- 3 Select [Firmware Update] → [Recovery Update] from the “Hardware” menu. The folder select dialog box will be displayed.
- 4 Select the folder that contains the update file, then click the [OK] button. The “Firmware Update” window will open.

NOTE

All connected DME units are displayed in the Device field.

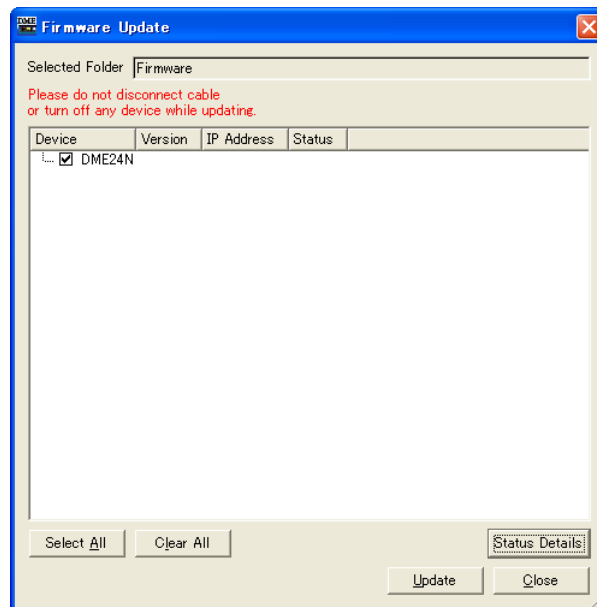

- 5 Check the DME, SP2060, or ICP1 unit to be restored. Clicking the checkboxes alternately turns the check mark on and off. The [Select All] button can be used to check all DME, SP2060, and ICP1 units. The [Clear All] button removes the check marks from all DME, SP2060, and ICP1 units.
- 6 When the DME, SP2060, and ICP1 units to be restored have been checked, click the [Update] button. The firmware restore process will begin.

NOTE

During the restore process do not disconnect any USB or Ethernet cables, or turn the DME, SP2060, or ICP1 power off. Doing so can result in loss of the DME Designer communication port settings.

When the restore update is complete the DME, SP2060, and ICP1 units will restart automatically. It is also necessary to restart the DME designer.

- 7 Update the firmware in the normal way. Select [Firmware Update] → [Program + Component] from the “Hardware” menu. (Page 187)

■ [MY4-AEC]

Update the firmware on an MY4-AEC Acoustic Echo Canceller card installed in a DME unit.

- 1 Select [Firmware Update] → [MY4-AEC] from the “Hardware” menu.
The “MY4-AEC Firmware Update” dialog box will appear.

NOTE

All connected DME units and MY4-AEC cards will appear in the “Device” column.

NOTE

The current MY4-AEC firmware version number is also displayed in this dialog box.

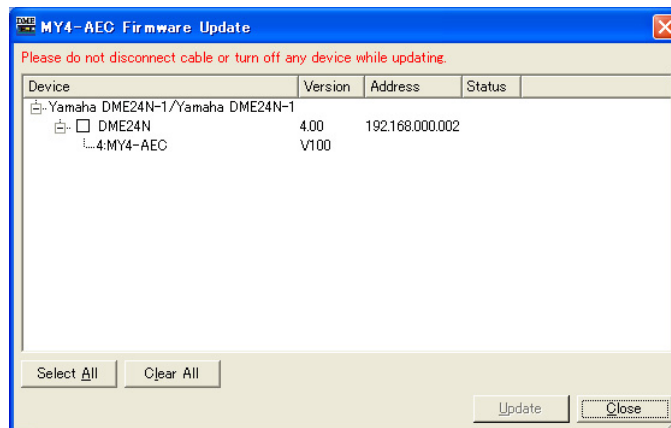

- 2 Check the checkbox for the DME unit in which the MY4-AEC card to be updated is installed.
Clicking the checkbox alternately checks and un-checks it. Click the [Select All] button if you want to select all connected DME units. Click the [Clear All] button to un-check all connected DME units.
- 3 Click the [Update] button.
The folder selection dialog box will appear.
- 4 Select the folder that contains the update file and click [OK].
The MY4-AEC update process will begin. The DME unit will automatically restart twice during the update process. The update process finishes when the second restart has completed. When the update process has finished it will be necessary to restart DME Designer.

NOTE

Be carefully not to disconnect any USB or Ethernet cables, or interrupt the power supply during the update process. Doing so can damage the MY4-AEC card and/or cause the DME Designer communication port settings to be lost.

NOTE

After the update check the firmware version number in the “MY4-AEC Firmware Update” dialog box to be sure that the update has been successful.

NOTE

If insufficient [Remaining Memory] is available (the amount of memory available in the DME unit – [page 111](#)), it may not be possible to complete the update process and an error message may appear in the Status field. If this occurs you will need to delete unnecessary files (files stored using the DME File Storage function, libraries, scenes) to make more memory available.

Device Information

Click [Device Information] in the [Hardware] menu to open the “Device Information” dialog box. The status of DME and SP2060 units connected to the network will be displayed as a list, even if they are offline or a configuration has not yet been created. This capability allows centralized DME management for effective troubleshooting and system maintenance.

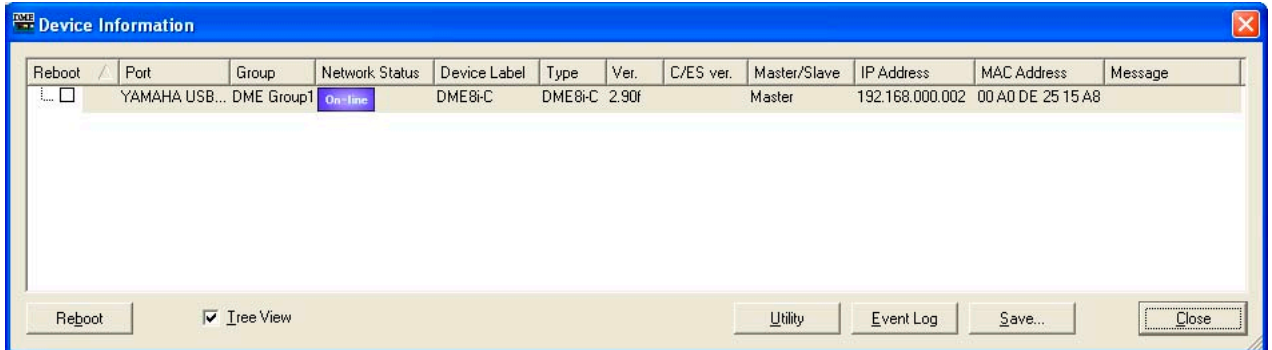

■ [Reboot]

If this checkbox is checked the [Reboot] button can be clicked to simultaneously reboot multiple DME and SP2060 units.

■ [Port]

Displays the name of the connected input/output port.

■ [Group]

Displays the name of the device group when online.

■ [Network Status]

Displays the online/offline status as an icon.

■ [Device Label]

Displays the name assigned to the DME or SP2060 unit.

■ [Type]

Displays the device type (DME64N, etc.).

■ [Ver.]

Displays the firmware version number.

■ [C/ES Ver.]

Displays the version number of CobraNet or EtherSound interface for DME Satellite units.

■ [Master/Slave]

Displays the device group master/slave setting.

■ [IP Address]

Displays the IP address.

■ [MAC Address]

Displays the MAC address.

■ [Message]

Displays messages being displayed on the DME unit display panel. On the most recent message is displayed.

■ [Tree View] Checkbox

When checked slaves are displayed below the master in tree form. When unchecked the devices are displayed as a list.

■ [Utility] Button

Opens the “Utility” dialog box for the currently selected device in the list.

■ [Event Log] Button

Opens the “Event Logger” dialog box for the currently selected device in the list.

■ [Save] Button

Saves the information being displayed as a CSV file (comma-delimited text file).

■ [Close] Button

Closes the dialog box.

Editing Configurations

Configurations

Information about inputs/outputs, along with the arrangement of components and how they are connected, is called a “**configuration.**” Configurations are created in the Designer window and sent to the DME unit.

In the Designer window, configurations are designed using various design windows, such as the Area, Zone, Configuration, and User Module windows. In each window a sheet is displayed, on which objects can be arranged.

New Configurations

Multiple zones can be created for an area, multiple device groups can be created for a zone, and multiple configurations can be created for a device group.

Zones can be added via the “Zone Manager” window, device groups can be added via the “Device Group and Sampling Frequency Settings” window, and configurations can be added via the “Configuration manager” window. Information about the “Zone Manager” window can be found in the “Adding, Deleting, and Renaming a Zone” section on [page 291](#), information on the “Device Group and Sampling Frequency Settings” window can be found in the “Device Group Selection” section on [page 276](#), and information on the “Configuration Manager” window can be found in the “Adding, Deleting, and Renaming a Configuration” section on [page 295](#).

Security

Editing in the Designer window can be restricted based on the user security settings. Only users for whom the [Operation Security] → [Edit] checkbox in the “Security” dialog box has been checked can display the Designer window and edit configurations.

For information about the “Security” dialog box, see “[Security \(Creating Users and Making User Settings\)](#)” on [page 82](#).

Edit Mode

There is an “Edit Mode” in the Designer window when offline status. When the Edit Mode is ON, configurations can be edited. When it is turned OFF, configurations cannot be edited. When online, the Edit Mode is OFF.

NOTE

SP2060 configurations cannot be edited.

■ Edit Mode ON/OFF

The edit mode can be turned on or off via the [Edit Mode] command in either the [Tools] menu or the contextual menu that appears when you right-click on the worksheet. You can also use the [Edit Mode] button in the menu bar. To turn Edit Mode ON click the command, placing a checkmark to the left of the command name. When there is a checkmark next to the command (when Edit Mode is ON), clicking the command again removes the checkmark and turns OFF the Edit Mode.

Edit Mode=ON

When Edit Mode is ON, you can do configuration editing tasks such as arranging objects, making connections, and changing properties.

Edit Mode=OFF

When Edit Mode is OFF, you can control the component editor, but cannot edit configurations. When offline, Edit Mode is OFF.

NOTE

Only users for whom the [Operation Security] → [Edit] checkbox in the "Security" dialog box has been checked can turn the Edit Mode ON.

Designer Window

You can display or hide the Designer window using the [Designer] command on the [View] menu in the Main Panel window.

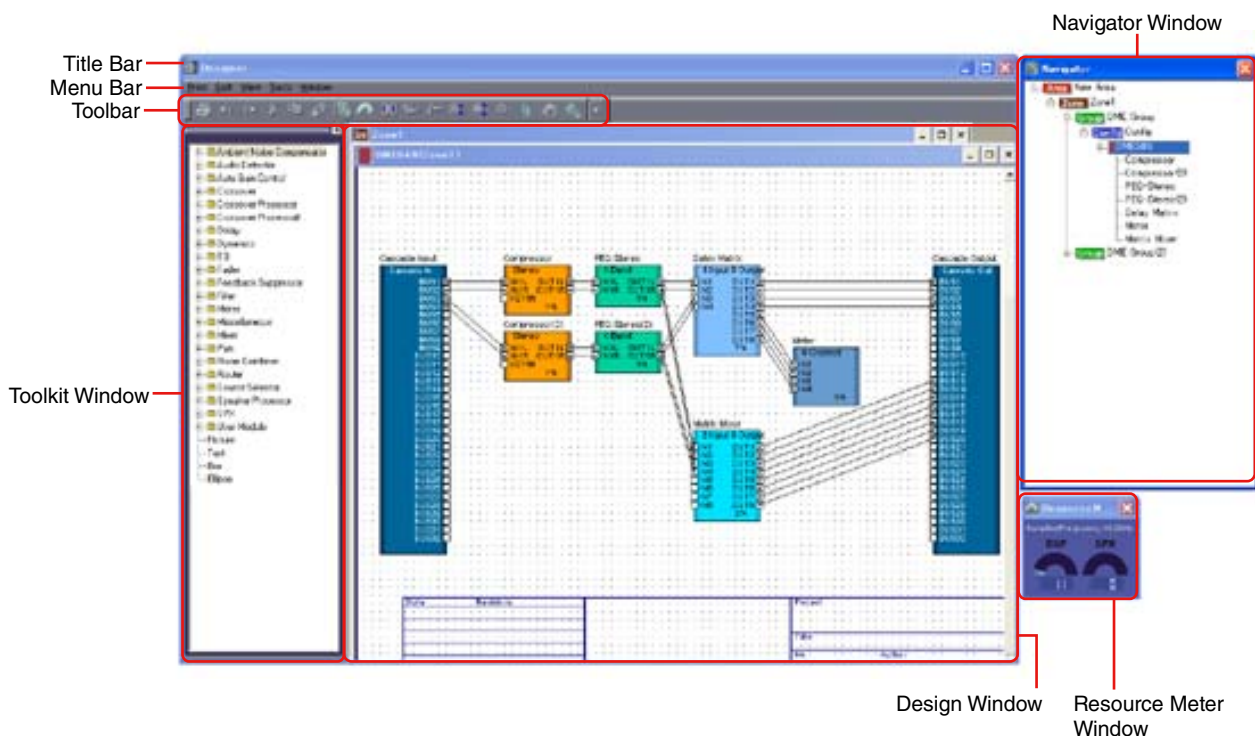

Title Bar

"Designer" is displayed on the title bar. You can move the window by dragging the title bar. There are [Minimize], [Maximize]/[Restore], and [Close] buttons at the right edge of the title bar.

Menu Bar

Commands that can be executed in the application are collected into categories on the menu bar. When you click one of the categories, a list of commands is displayed.

Toolbar

Frequently used commands are arranged here as buttons.

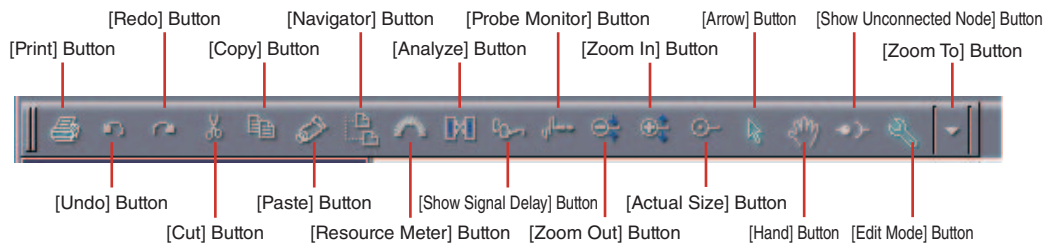

■ [Print] Button (page 203)

Prints the active design window.

■ [Undo] Button (page 204)

Undoes the most recent edit operation.

■ [Redo] Button (page 204)

Restores operations undone with the [Undo] button back to their original condition.

■ [Cut] Button (page 204)

Cuts the selected object from the screen and moves it to the clipboard.

■ [Copy] Button (page 204)

Copies the selected object to the clipboard.

■ [Paste] Button (page 204)

Pastes data from the clipboard.

■ [Navigator] Button (page 197)

Displays or hides the Navigator window.

■ [Resource Meter] Button (page 196)

Displays or hides the Resource Meter window.

■ [Analyze] Button (page 208)

Displays the “Analyze” dialog box, and analyzes the configuration.

■ [Show Signal Delay] Button

The digital signal delay value is displayed in the Configuration window.

→ “Show Signal Delay (Delay Display Value)” in “Configuration Window” (page 305)

■ [Probe Monitor] Button

Turns the probe monitor ON or OFF.

→ “Probe Monitor” in “Configuration Window” (page 303)

■ [Zoom Out]/[Zoom In]/[Actual Size]/[Zoom To] Buttons

These buttons correspond to the commands on the [View] menu with the same names. Changes the magnification of the display on the screen.

→ “[View] Menu” in “Designer Window Menus” ([page 205](#))

■ [Arrow] Button

The mouse cursor appears as crosshairs, and can be used to select objects.

■ [Hand] Button

The mouse cursor appears as a hand shape, and can be used to click and “grab” the worksheet for scrolling.

■ [Show Unconnected Node] Button

Displays unconnected nodes.

→ “Show Unconnected Node”([page 290](#))

■ [Edit Mode] Button

Turns the edit mode ON or OFF.

→ “Edit Mode” ([page 195](#)) in the “Configuration Editing” section.

Status Bar

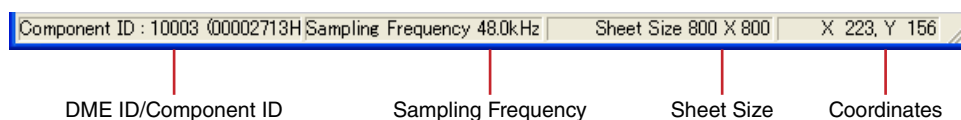

■ DME ID/Component ID

When the mouse pointer is moved over a DME device in the Zone window, the ID for that DME device is displayed. When the mouse pointer is moved over a component in the Configuration window, the ID for the component is displayed.

■ Sampling Frequency

Displays the sampling frequency in the configuration window.

■ Sheet size

Displays the size of the sheet in the active design window.

■ Coordinates

Displays the coordinates of the mouse pointer any time it is within the design window. When dragging an object, the coordinates displayed here refer to the upper left corner of the object being dragged.

Resource Meter Window

The Resource Meter can be displayed or hidden via the [Navigator] command in the [View] menu. The Resource Meter window is displayed only when the Configuration window and User Module window are active. Meters for the DSP memory usage percentage and the SPX resource usage percentage are in the Resource Meter window. The sampling frequency of each DME unit is also displayed.

NOTE

Not displayed in the SP2060 configuration window.

■ DSP Memory Usage Percentage

When you are designing in the Configuration window, it gives you a yardstick for judging the total usage percentage for DSP memory in the DME unit. In addition, the usage percentage varies depending on the sampling frequency, even for the same component.

When the configuration is synchronized with the DME unit during online status, checks of connections and component information begin automatically (this is called compiling). The actual total usage percentage is calculated after this compiling operation. The usage percentage will vary according to the number of connections and components. The Resource Meter window gives you a precompile guideline for use while designing your configuration. An error may occur even when the meter shows less than 100 percent, based on conditions such as the number of connections, and type and number of components used. We recommend using the “Analyze” dialog box ([page 308](#)) to check whether compilation will be successful before actually performing the compilation.

NOTE

If a configuration is compiled at $f_s=44.1\text{kHz}$ or 48kHz , and the sampling frequency is then changed to 88.2kHz or 96kHz , it is necessary to recompile at 88.2kHz or 96kHz . If this is not done some configurations may produce no sound. In such cases a “DSP Power Shortage” message will be displayed on the DME unit.

■ SPX Resource Usage Ratio

Displays the resource usage ratio for SPX components and Feedback Suppressor components arranged in the configuration.

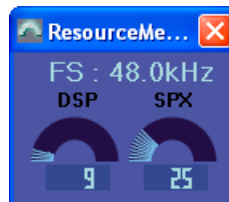

NOTE

The components that can be placed in the configuration window vary according to the device type. For details, see “Component List” on [page 372](#).

NOTE

If the [Matrix Mixer 64 input 64 output] or the [Matrix Mixer 64 input 32 output] components are placed in the DME64N configuration window, you will not be able to use other components, even though the window does not reach 100 percent.

Navigator Window

The Navigator window can be displayed or hidden via the [View] menu [Navigator] or the tool button (large) [Show/Hide Navigator] button in the main window, or via the [View] menu [Navigator] command in the designer window.

Gives a hierarchical display of the area, zones, and configurations, along with the DME devices, user modules and components arranged within the configurations. This allows you to check the overall status of your setup.

You can click the icon or name for an area, zone, configuration, DME device, user module, or component to make each design window active.

NOTE

For user modules with security enabled, a password is requested when displaying the hierarchical display shown below.

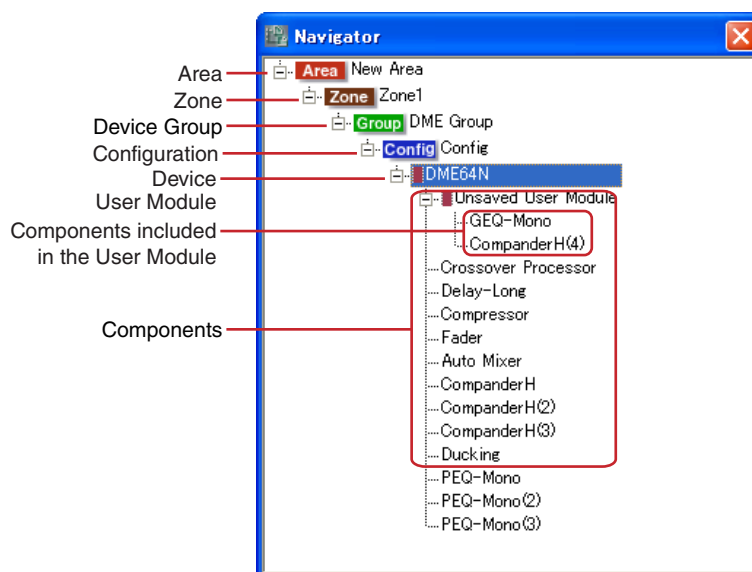

■ [+] / [-]

The subordinate items are displayed or hidden using the [+] / [-] buttons to the left of the area, zones, configurations, user modules, or DME devices. When the subordinate items are displayed, the button changes to [-]. If you click this button, the subordinate items will be hidden. When the subordinate items are hidden, the button changes to [+]. If you click this button, the subordinate items will be displayed.

Subordinate items are also displayed and the button changes to [-] when you click on an area, zone, configuration, user module, or DME device.

■ Area

If you click the area the Area window becomes active.

■ Zone

If you click a zone the Zone window becomes active. If another Zone window is open, zone will be switched.

NOTE

When there are multiple configurations in a zone, click a configuration to switch configurations, not the zone.

■ Device Group

If a group is clicked the zone window of the clicked group will become active. If a window for another zone is open at the time, zone will be switched.

■ Configuration

If a configuration is clicked the clicked configuration will be selected.

■ Device

If you click a device, a Configuration window will be opened for that unit. If that window is already open, it will be displayed on top of any other windows.

■ Component

Click a component and the component editor will open.

■ User Module

The window specified by “User Module Properties [Double Click Action]” will open when clicked.

■ Components Included in the User Module

Click a component in the user module and the component editor will be displayed.

Toolkit Window

The Toolkit displays objects that can be arranged in each design window. The displayed contents vary according to which window is active.

→ See “Objects” on [page 210](#).

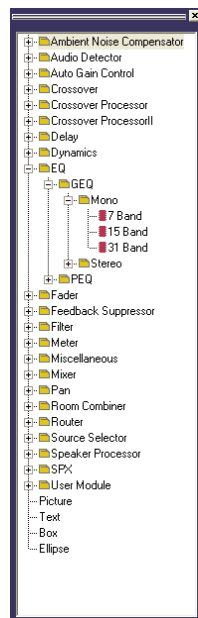

Displayed in the designer window

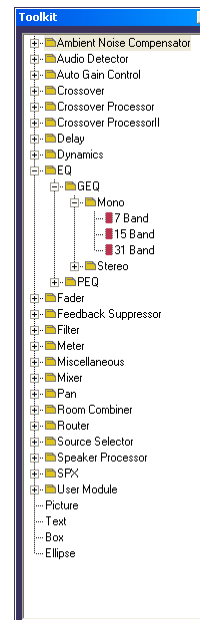

Floating-style

Displaying the Toolkit Window

You can display or hide the Toolkit window using the [Toolkit] command on the [View] menu. The Toolkit displays objects that can be arranged in each design window. You can arrange objects in each design window by dragging them from the Toolkit window or by double-clicking them in the Toolkit window.

The objects are categorized by type and displayed here in a hierarchy. You can use the [+] / [-] buttons to display or hide items below a particular level in the window. Click the [+] button to display the items on the next level down, and the [-] button to hide them.

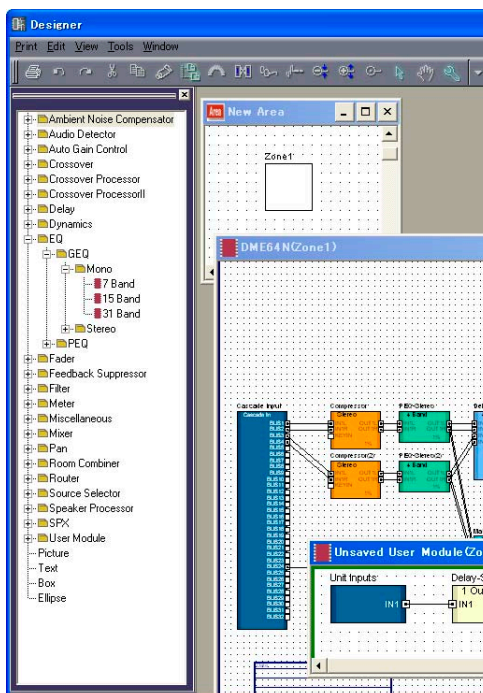

Moving the Toolkit Window

You can move the Toolkit window by dragging it. If you drag the window to right or left side, it will remain fixed. If you drag it to other locations, it will float independently. When DME Designer is started for the first time, the Toolkit window is displayed at the left side of the Designer window.

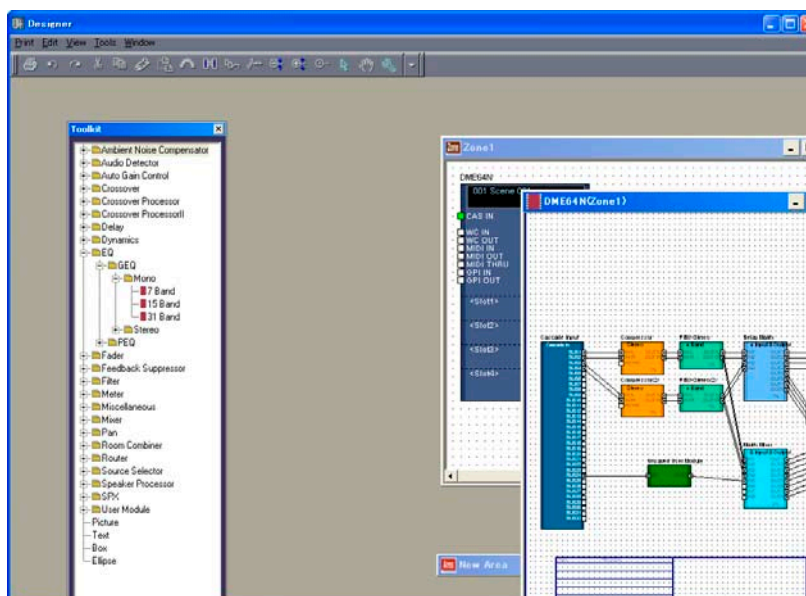

Toolkit Window Types

The contents of the Toolkit window will vary, depending on which window is active.

Active Design Window	Toolkit Window
Area Window	Area Parts List
Zone Window	Device List
Configuration Window	Component List
User Module Window	Component List

The following objects are displayed in each window:

	Area Parts List	Device List	Component List (Configuration Window)	Component List (User Module Window)
DME		✓		
ICP		✓		
SP2060		✓		
External Device	✓	✓		
Component			✓	✓
SPX Component			✓	✓
User Module			✓	
Pictures	✓	✓	✓	✓
Text	✓	✓	✓	✓
Boxes	✓	✓	✓	✓
Ellipses	✓	✓	✓	✓

[Area Parts List]

The [Area Parts List] displays objects that can be arranged in the Area window. The same objects are displayed in the [Area Parts List] submenu on the [Tools] menu or on the context menu that appears when you right-click on the sheet.

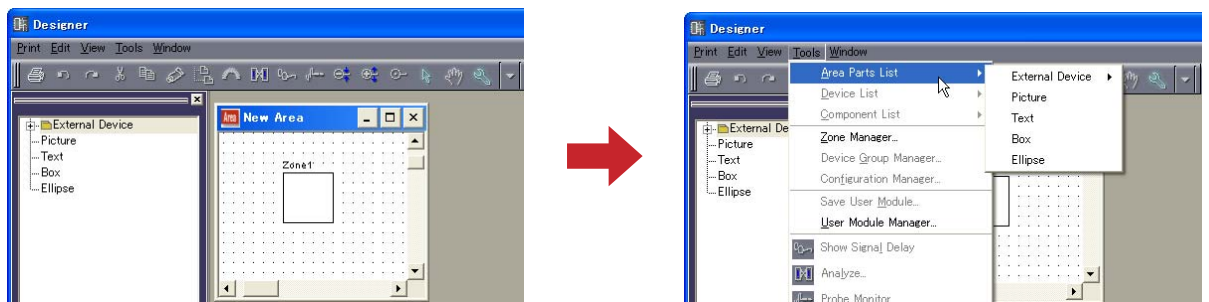

NOTE

You can create multiple zones in an area. They are added using the menu bar [Tool] menu → “Zone” dialog box.

[Device List]

The Device list displays objects that can be arranged in a Zone window (configuration). The same objects are displayed in the [Device List] submenu on the [Tools] menu or on the context menu that appears when you right-click on the sheet.

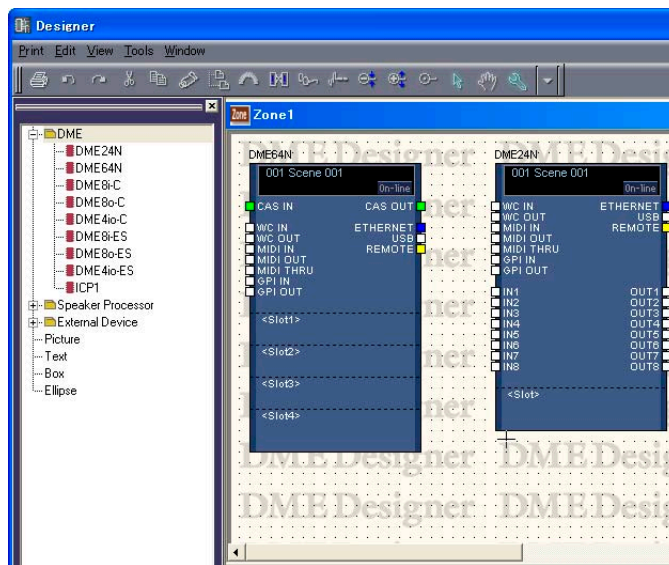

Toolkit window

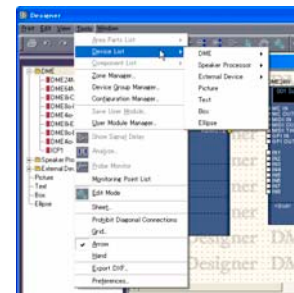

[Tools] menu

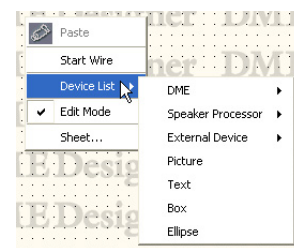

[Device List] submenu on the [Tools] menu or on the context menu

NOTE

Configurations are added using the menu bar [Tool] menu → “Configuration Manager” dialog box.

[Component List] (Configuration Window)

The Component List displays objects that can be arranged in Configuration windows. The same objects are displayed in the [Component List] submenu on the [Tools] menu or on the context menu that appears when you right-click on the sheet.

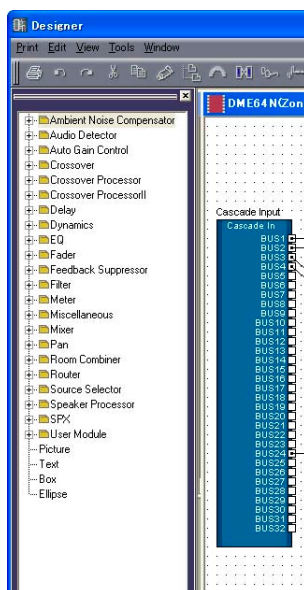

Toolkit window

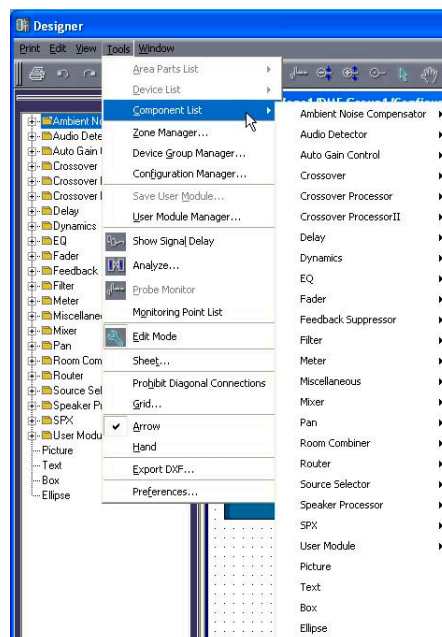

[Tools] menu

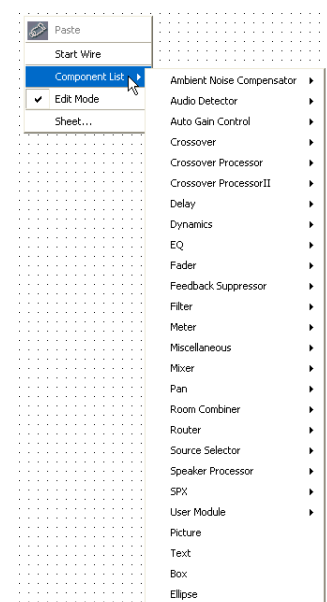

[Component List] submenu on the [Tools] menu or on the context menu

[Component List] (User Module Window)

The Component List displays objects that can be arranged in the User Module window. The same objects are displayed in the [Component List] submenu on the [Tools] menu or on the context menu that appears when you right-click on the sheet.

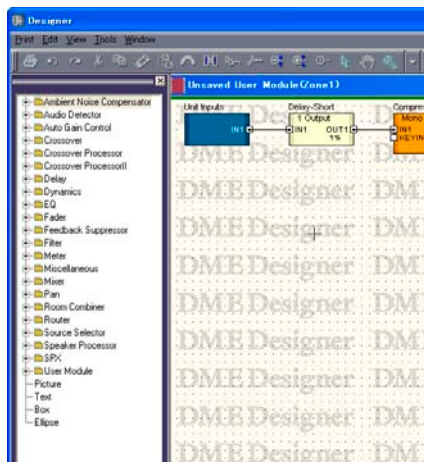

Toolkit window

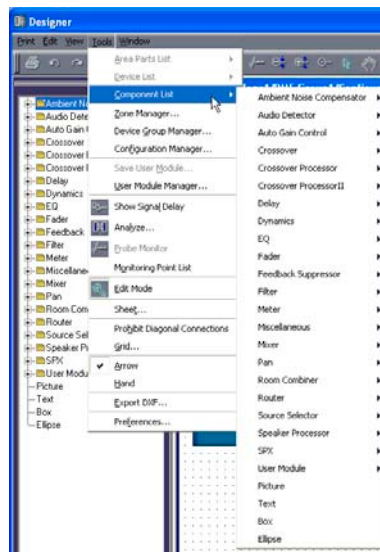

[Tools] menu

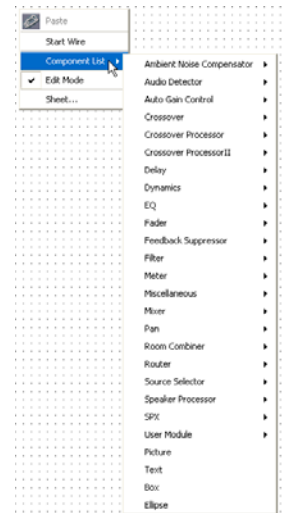

[Component List] submenu on the [Tools] menu or on the context menu

Four Design Windows

The following design windows are available: the Area window, Zone window, Configuration window, and User Module window. In each window there is a single sheet on which objects can be arranged. Within the Designer window, you can simultaneously open and edit in the Area window, Zone Window, Configuration window, and User Module window.

Configuration Structure and Four Design Windows

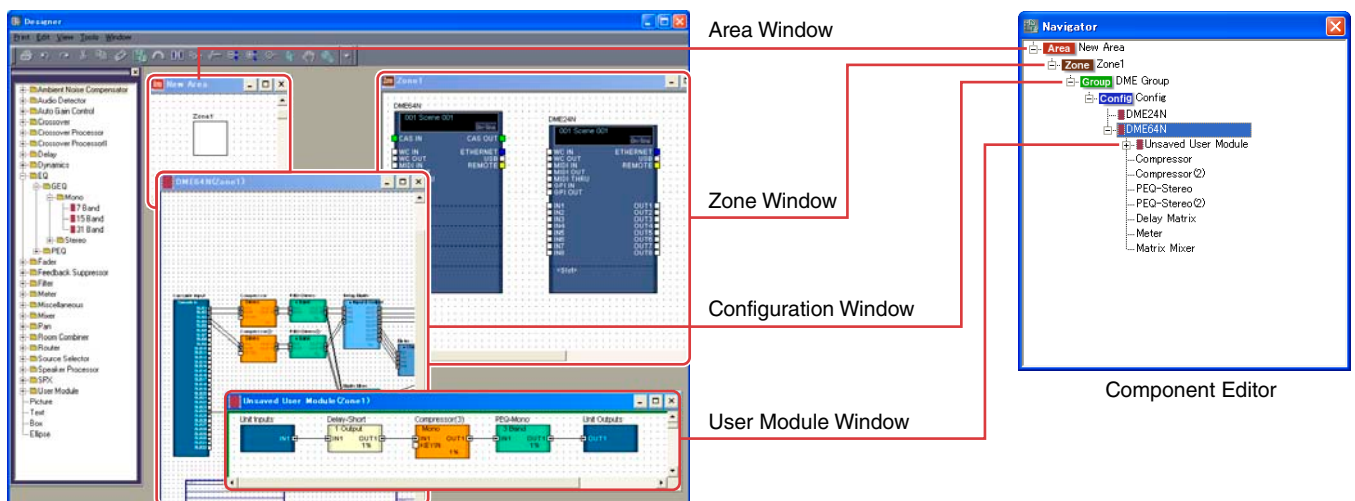

■ Area Window

Used to design areas.
→ See “Area Window” on [page 297](#).

■ Zone Window

Used to design zone configurations.
→ See “Zone Window” on [page 298](#).

■ Configuration Window

Used to design configurations for DME units arranged in a zone.
→ See “Configuration Window” on [page 301](#).

■ User Module Window

Used to design user modules configurations. A module that combines a number of other components, yet is treated as a single component, is called a “**user module**.” It is arranged in the Configuration window.

→ See “[Component List] (User Module Window)” on [page 202](#).

Designer Window Menu

[Print] Menu

This menu provides commands for exporting configurations and printing windows.

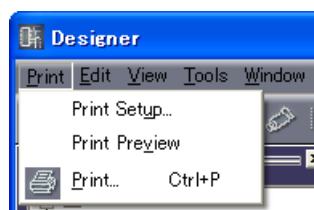

■ [Print Setup]

When you select this command, the “Print Setup” dialog box will be displayed. Sets the paper size and orientation.

→ “Printing Each Design Window” in “Design Window Shared Settings and Operations” ([page 274](#))

■ [Print Preview]

Displays a print preview of the active design window.

→ “Print Preview” window in “Design Window Shared Settings and Operations” ([page 275](#))

■ [Print]

Prints the active window. When you select this command, the “Print” dialog box will be displayed.

→ “Printing Each Design Window” in “Design Window Shared Settings and Operations” ([page 274](#))

["Print" dialog box]

Enter the number of copies to print into the [Number of Copies] box, and click the [Print] button.

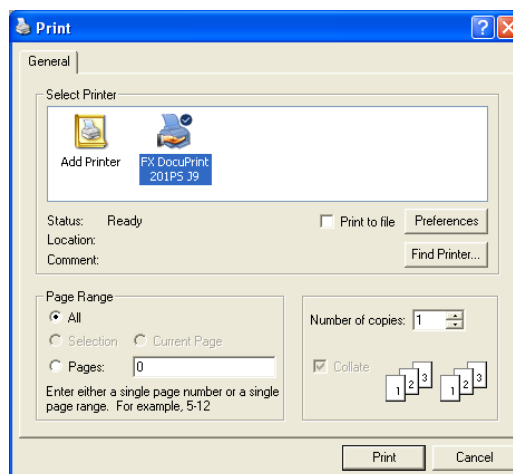

[Edit] Menu

This menu provides edit commands.

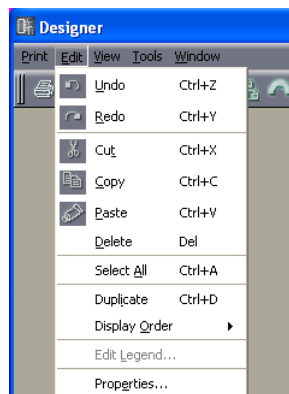

■ [Undo]

Undoes the most recent edit operation. Repeatedly clicking this button will delete multiple operations. When [Undo] is not possible, the command will be grayed out.

■ [Redo]

Returns to the status before the [Undo] command was executed. If you repeatedly click this button, it will redo multiple operations. If redo is not possible, the command will be grayed out.

■ [Cut]

Cuts the selected object. Moves the selected object to the clipboard.

■ [Copy]

Copies the selected object to the clipboard. The selected object remains as is.

■ [Paste]

This command pastes the object on the clipboard into the active window. If there is no data on the clipboard or if the object on the clipboard is not a type that can be pasted into the active window, this command cannot be used.

■ [Delete]

Deletes the selected object. The data on the clipboard does not change.

NOTE

There are some objects that cannot be deleted with the [Delete] command.

■ [Select All]

Selects all objects in the active design window.

■ [Duplicate]

Duplicates the selected object. The data on the clipboard does not change.

■ [Display Order]

Changes the display order (in front or behind) of the selected objects.

→ “Changing the Order” in “Design Window Shared Settings and Operations” ([page 278](#))

■ [Edit Legend]

This command can be selected when an Area window, Zone window, or Configuration window is active. It lets you edit the descriptive text (legend) displayed on the sheet in the Area window, Zone window, or Configuration window. When this command is selected, the “Edit Legend” dialog box will be displayed.

→ “Legend (Descriptive Fields)” in “Objects” ([page 260](#))

■ [Properties]

Opens the “Properties” dialog box for the selected objects.

→ See “Object Types” on [page 210](#).

[View] Menu

Displays or hides the windows.

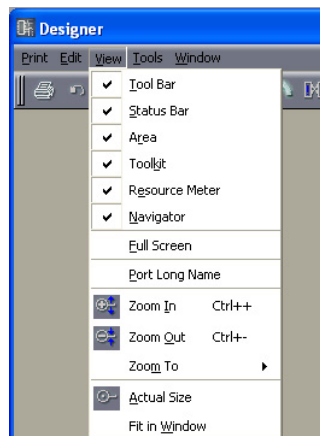

■ [Toolbar]

Displays or hides the toolbar. A checkmark appears beside this menu item when the toolbar is displayed.

■ [Status Bar]

Displays or hides the status bar. A checkmark appears beside this menu item when the status bar is displayed.

■ [Area]/[Toolkit]/[Resource Meter]/[Navigator]

Displays or hides the Area window, Toolkit, Resource Meter, or Navigator window. A checkmark appears to the left of the command name when a window is displayed.

The Resource Meter window is displayed only when the Configuration window and User Module window are active.

■ **[Full Screen]**

Displays in full-screen mode. Displays the active design window (Area, Zone, Configuration, or User Module window) exclusively, with it covering the entire screen.

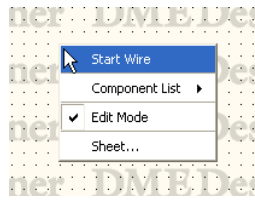

A context menu appears wherever you right-click on the screen, containing the commands that are needed at that location.

To return from the full-screen mode to the original display status, press the <Esc> key.

■ **[Port Long Name]**

Switches the port name display of the slot components. When you select this command, a checkmark appears next to it and long names are displayed. If you select this command when a checkmark is next to it, the checkmark disappears and short names are displayed.

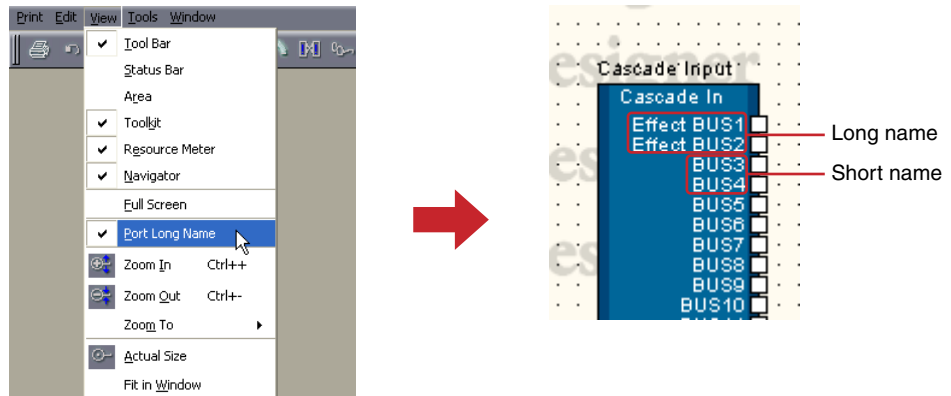

■ **[Zoom In]**

Gives a closer view of an area displayed on the screen.

■ **[Zoom Out]**

Widens the area displayed on the screen.

■ **[Zoom To]**

Selects the display magnification from a submenu.

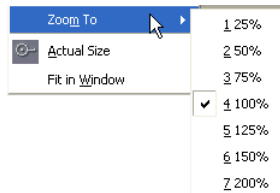

■ **[Actual Size]**

Returns the display to normal dimensions.

■ **[Fit in Window]**

Increases or decreases the display magnification so that the sheet exactly fits the current window. The entire sheet will be visible.

[Tools] Menu

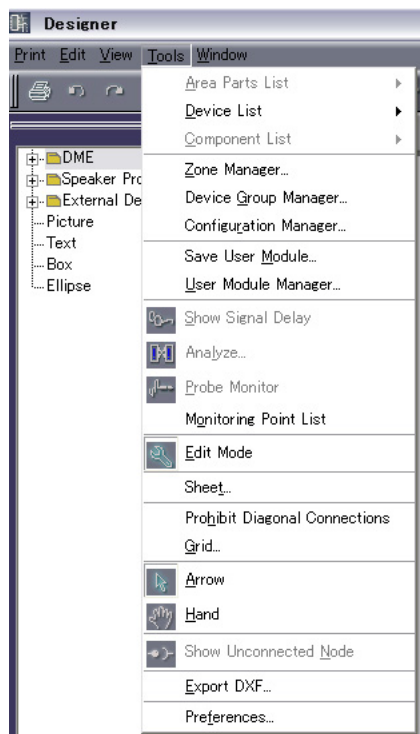

■ [Area Parts List]

This command can be used only when the Area window is active. A submenu displays the same objects that are in the Toolkit window displayed while the Area window is active. Clicking an object on the submenu, then clicking the Area window, places that object in the Area window.
→ [Area Parts List] in “Toolkit Window” ([page 200](#))

■ [Device List]

This command can be used only when the Zone window is active. A submenu here displays the same objects as the Toolkit window. Clicking an object on the submenu, then clicking the Zone window, places that object in the Zone window.
→ [Zone Device List] in “Toolkit Window” ([page 201](#))

■ [Component List]

This command can be used only when a Configuration window or User Module window is active. A submenu here displays the same objects as the Toolkit window. Clicking an object on the submenu, then clicking the Configuration/User Module window, places the object in that window.
→ “Component List (Configuration Window)” in “Toolkit Window” ([page 201](#)), “Component List (User Module Window)” in “Toolkit Window” ([page 202](#))

■ [Zone Manager]

Displays the “Zone Manager” dialog box. Here you can add, delete, or rename a zone.
→ See “Adding, Deleting, and Renaming a Zone” on [page 291](#).

■ [Device Group Manager]

Displays the [Device Group Manager] window, allowing the device group to be changed.
→ “Changing the Device Group” ([page 293](#)).

■ [Configuration Manager]

Displays the “Configuration Manager” dialog box. Here you can add, delete, or rename a configuration.

→ See “Adding, Deleting, and Renaming a Configuration” on [page 295](#).

■ [Save User Module]

This command can be used only when a User Module is selected in the Configuration window. Saves a template for the selected user module.

→ “User Module Manager” Dialog Box in “User Modules” ([page 310](#))

■ [User Module Manager]

Displays the “User Module Manager” dialog box. Changes the settings of, renames, or deletes a user module saved as a template.

→ “User Module Manager” Dialog Box in “User Modules” ([page 314](#))

■ [Show Signal Delay]

The digital signal delay value is displayed in the configuration window with sample units.

→ “Show Signal Delay (Delay Display Value)” in “Configuration Window” ([page 305](#))

■ [Analyze]

Displays the “Analyze” dialog box, and analyzes the configuration.

→ “Analyze (Configuration Analysis)” in “Configuration Window” ([page 308](#))

■ [Probe Monitor]

Turns the probe monitor ON or OFF. This command can be selected only when a Configuration window or User Module window is active while in online status.

→ “Probe Monitor” in “Configuration Window” ([page 303](#))

■ [Monitoring Point List]

Opens the “Monitoring Point List” dialog box. Registers points for monitoring with headphones.

→ “Monitoring Point List” in “Configuration Window” ([page 306](#))

■ [Edit Mode]

Turns the edit mode ON or OFF.

→ “Edit Mode” in “Editing Configurations” ([page 192](#))

NOTE

Only users for whom the [Operation Security] → [Edit] checkbox in the “Security” dialog box has been checked can select this command.

■ [Sheet]

Opens the “Sheet Settings” dialog box. Sets the sheet size and background.

→ “Sheet” in “Objects” ([page 262](#))

■ [Prohibit Diagonal Connections]

All connections will be drawn with horizontal and vertical wires only. Diagonal wires cannot be drawn.

→ “Drawing Settings” in “Drawing and Editing Wires” ([page 282](#))

■ [Grid]

Opens the “Grid” dialog box. Displays or hides the grid and sets the grid spacing.

→ “Grid” in “Design Window Shared Settings and Operations” ([page 270](#))

■ [Arrow]

The mouse cursor appears as crosshairs, and can be used to select objects.

■ [Hand]

The mouse cursor appears as a hand shape, and can be used to click and “grab” the worksheet for scrolling.

■ [Show Unconnected Node]

Displays unconnected nodes.

→ “Show Unconnected Node”(page 290)

■ [Export DXF]

Exports the information in the active window and saves it as a DXF file, which is compatible with CAD software sold by other companies.

→ “Exporting the Design Window” in “Design Window Shared Settings and Operations” (page 271)

■ [Preferences]

Displays the “Preferences” dialog box. Sets the line thickness and the design window edit operations.

→ “Preferences” in “Design Window Shared Settings and Operations” (page 268)

[Window] Menu

Arranges multiple windows. The lower part of the menu displays the names of currently open windows. A checkmark appears next to the active window. When you click the name of a window, that window becomes active.

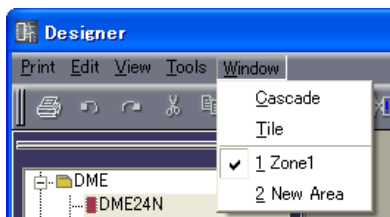

■ [Cascade]

Displays the windows overlapping one another.

■ [Tile]

Displays the windows arranged side-by-side.

Objects

Object Types

The devices, shapes, and wires that can be arranged in each design window are called “Objects.” The following objects are available:

Name	Window Where It can be Placed/Displayed	Explanation
Zone	Area	Zones
DME	Zones	DME and any cards inserted into its slots
ICP	Zones	User defined parameter control
SP2060	Zones	Speaker Processor
External Device	Area, Zones	External Device
Component	Configuration User Module	User Module, Audio processor, Control parts
SPX Component	Configuration User Module	SPX components
User Module	Configuration	Combination of components
Slot Component	Configuration	Internal DME I/O or installed I/O cards.
Pictures	All	Image
Text	All	Text box
Boxes	All	Box shape
Ellipses	All	Circular shape
Wires	All	Connecting wire, straight line shape
Legend	Area Zones Configuration	An area displayed on the sheet where descriptive information is presented.
Sheet	--	One sheet per design window.

Various design elements, such as name, color and size, can be set in the “Properties” dialog box for each object.

Size is set using the [Width] and [Height] boxes in the “Properties” dialog box. The maximum size values that can be set may vary according to the sheet size and object position. You can set a size that allows the object to fit in the sheet.

Zone

There must be at least one zone in the Area window. Zones are added and deleted using the “Zone” dialog box. Zones are not displayed in the Toolkit window or in the [Area Parts List] submenu in the [Tools] Menu

If you right-click on the name of a zone object located in the Area window, a context menu will be displayed.

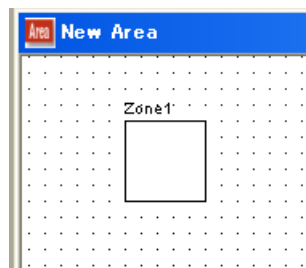

■ Zone Context Menu

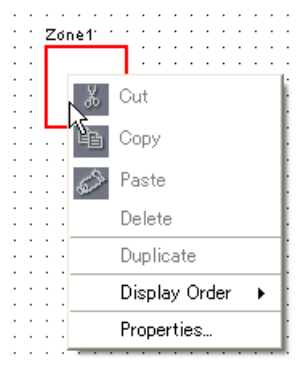

NOTE

[Cut], [Copy], [Paste], and [Delete] are grayed out and cannot be selected.

[Display Order]

Changes the display order of the objects, according to a command in the submenu.

[Properties]

Displays the “Zone Properties” dialog box.

■ Zone Object Properties

When you select a zone in the Area window, then click the [Properties] command on the [Edit] menu, the “Zone Properties” dialog box is displayed. Here you can set properties for zone objects. The [Properties] command is also located on the context menu for zone objects.

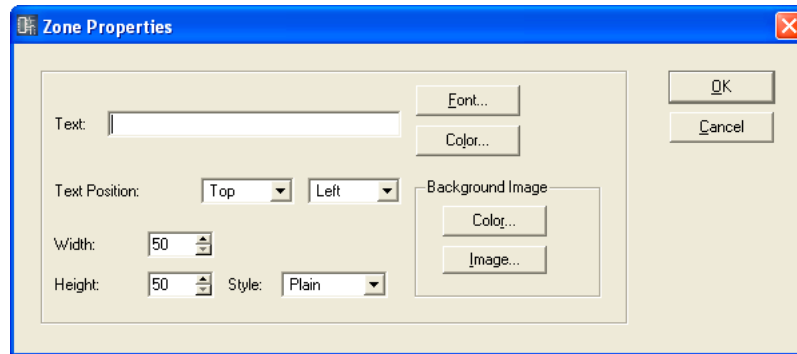

[Text] Box

You can enter up to 100 English characters for the object name.

The object name is displayed in the rectangular box for the object. If there is a large number of characters and the object’s shape is too narrow, all characters might not be displayed.

[Font] Button

Clicking here displays the “Select Font” dialog box. This sets the font used to display the object name.

For information about the “Select Font” dialog box, see [page 264](#).

[Color] Button

Clicking here displays the “Select Color” dialog box. This sets the color of the object name text.

For information about the “Select Color” dialog box, see [page 265](#).

Text Position

Sets the location of the text. The list to the left sets the vertical position of the text. The list to the right sets the horizontal position.

- **Vertical Position**
Select [Top], [Center], or [Bottom].
- **Horizontal Position**
Select [Left], [Center], or [Right].

[Width] Box

Specifies the width of the object in pixels. The default is 50 pixels.

[Height] Box

Specifies the height of the object in pixels. The default is 50 pixels.

[Style]

Sets the style of the object. From the list, select [Plain], [Raised], or [Sunken].

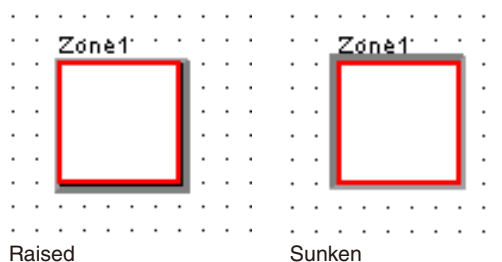
**Background Image**

Sets background effects for the object.

- **[Color] Button**

Sets the color. Clicking here displays the “Select Color” dialog box.

For information about the “Select Color” dialog box, see [page 265](#).

- **[Image] Button**

Displays an image inside the object. You can use image files in the following formats: BMP (.bmp), PNG (.png), XPM (.xpm), and JPEG (.jpg). Clicking here displays the “Select Image” dialog box. Specify an image file and set its display method.

For information about the “Select Image” dialog box, see [page 267](#).

[OK] Button

Accepts the changed settings and closes the dialog box.

[Cancel] Button

Closes the dialog box without changing the settings.

DME

DMEs are arranged in the Zone window. If DME properties settings have been made for an expansion card installed in one of the DME slots, the card will be displayed automatically.

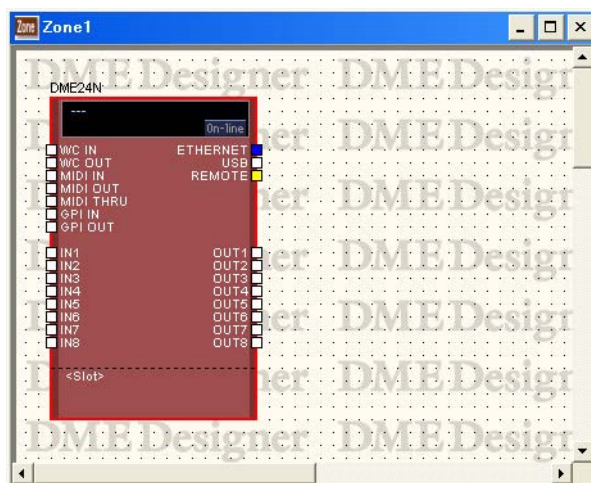
DME24N

DME24N with no I/O card installed.

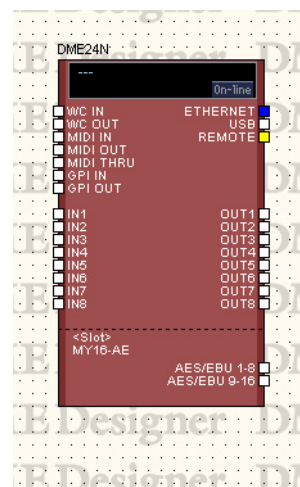

DME24N with an I/O card installed in its expansion slot.

DME64N

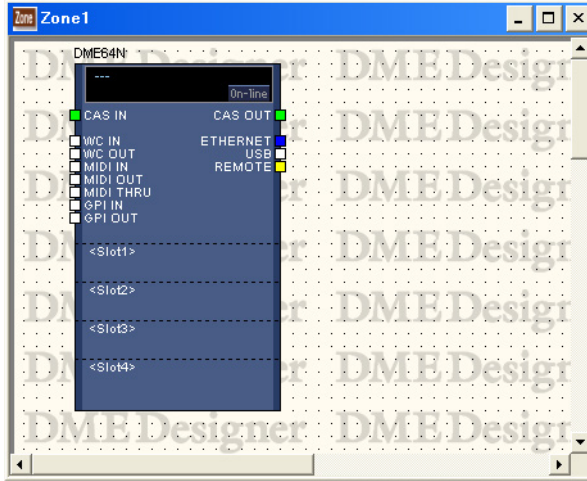

DME64N with no I/O cards connected in slots.

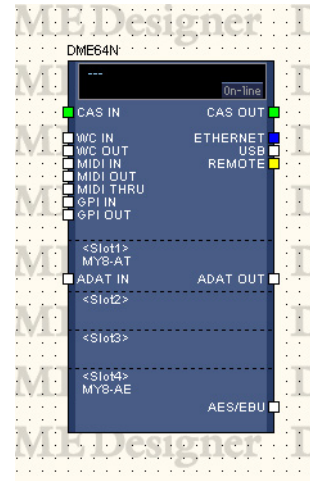

DME64N with I/O cards installed in expansion slots 1 and 4.

DME8i-C/DME8o-C/DME4io-C

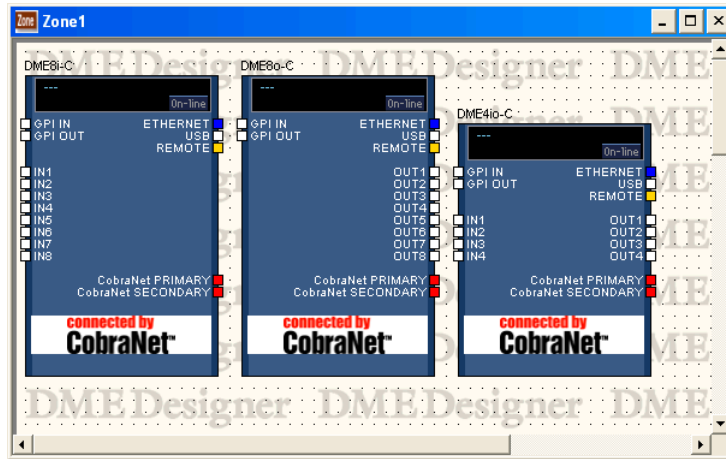

DME8i-ES/DME8o-ES/DME4io-ES

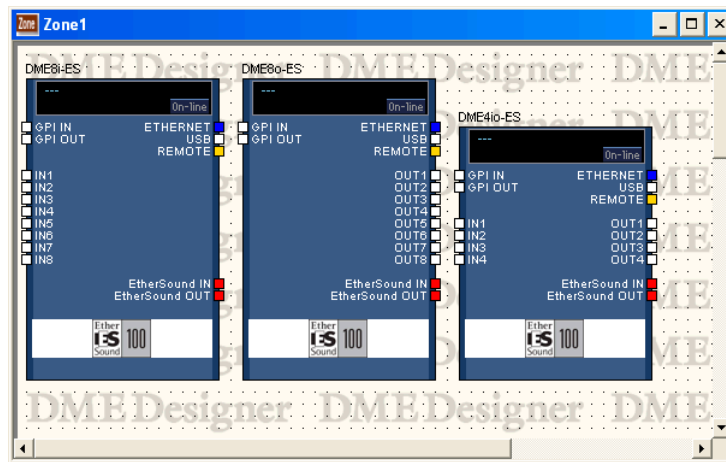

When I/O Cards Are Installed in DME Expansion Slots

When an I/O card is selected for an expansion slot in the DME properties, an I/O port is added for the DME arranged in the Zone window. An I/O component block will be added to the configuration window.

If [None] is selected for I/O cards in the DME properties, any I/O component blocks will also be deleted automatically from the Configuration window. (Even if the I/O components are deleted, the wiring will remain.)

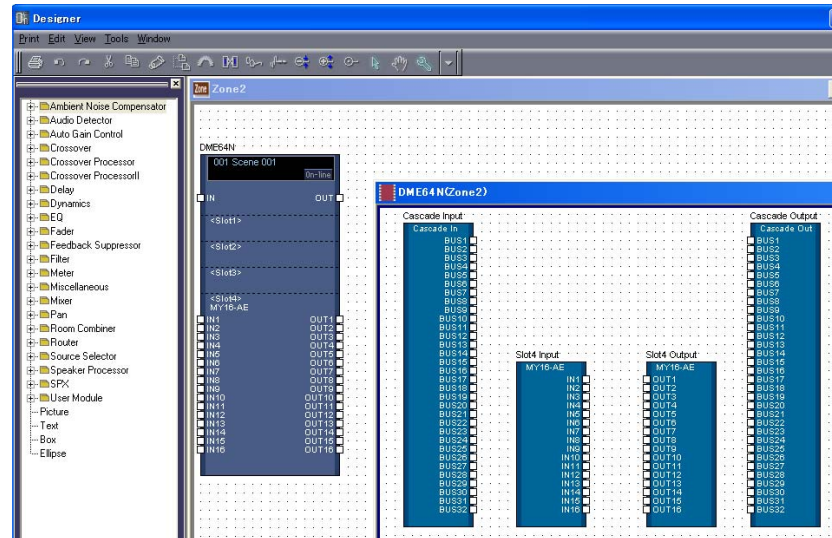

DME64N block with card inserted in a slot and the Configuration window

When the DME64N Cascade Setting is Turned ON

When [Show Cascade Port on Configuration Window] is checked in the DME64N “DME Device Properties” dialog box, the cascade I/O components will be displayed in the Configuration window. If [Show Cascade Port on Configuration Window] is turned OFF in the DME64N “DME Device Properties” dialog box, cascade I/O components will also be deleted automatically in the Configuration window. (Even if the Cascade I/O components are deleted, the wiring will remain.)

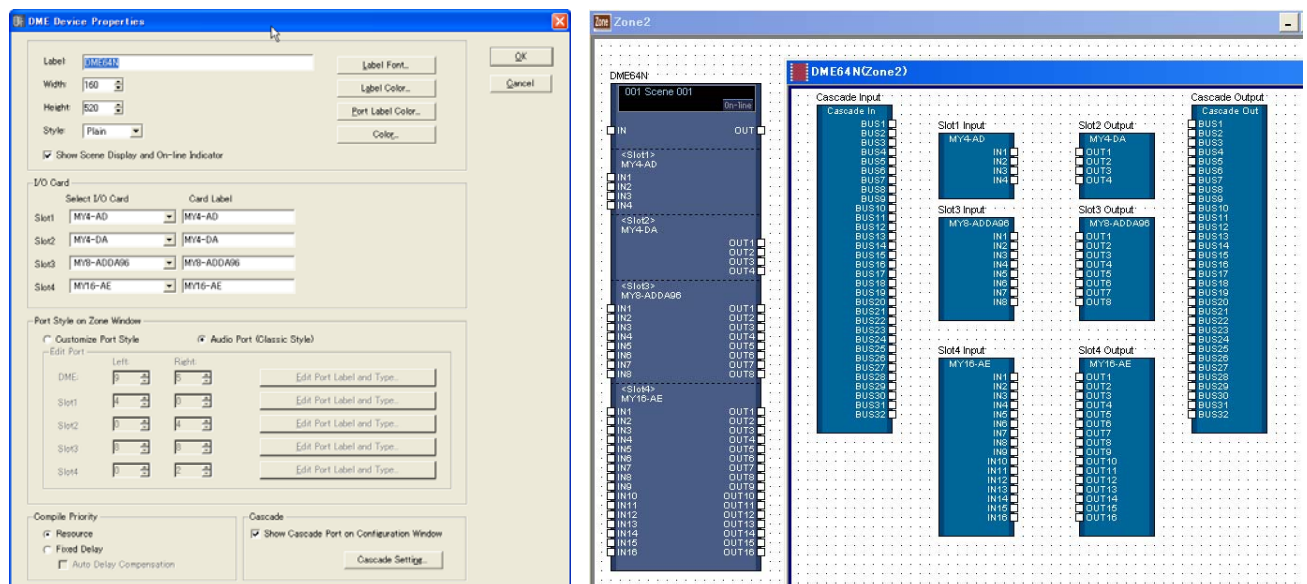

CobraNet Card/EtherSound Card

If the I/O card is a CobraNet card or EtherSound card a CobraNet icon or EtherSound icon will be displayed in the DME object.

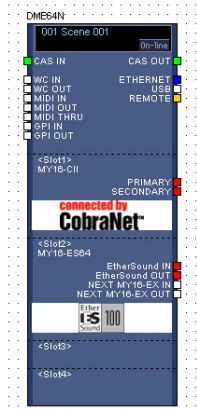

DME block with CobraNet card and Ether Sound card inserted

Object Selection

To open a configuration window for a DME object arranged in the Zone window, first select it by clicking on it, then double-click on it. If you right-click on the object, a context menu will be displayed.

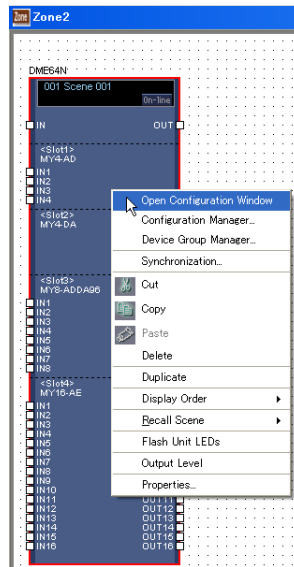

Scene Info and [On-line] Button

DME objects include an object that provides scene info and an [On-line] button.

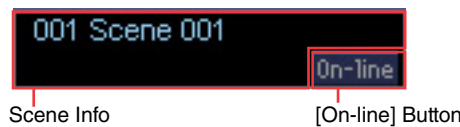

The scene info area displays the current scene number and name. Click the scene info area to open the “Scene Manager” window.

The [On-line] button has the same function as the [On-line] button in the main panel window.

→ “[On-line] Button” (page 59).

■ DME Object Context Menu

[Open Configuration Window]

Opens the Configuration window.
→ See “Configuration Window” on [page 301](#).

[Device Group Manager]

Opens the Device Group Manager window
→ See “Device Group Manager” on [page 293](#)

[Configuration Manger]

Opens the Configuration Manager window.
→ See “Configuration Manager” on [page 295](#).

[Synchronization]

Opens the Synchronization window
→ See “Synchronization
(DME Designer and Unit Synchronization)” on [page 97](#)

[Cut]

Cuts the selected object and moves it to the clipboard.

[Copy]

Copies the selected object to the clipboard.

[Paste]

Pastes the DME object that is on the clipboard.

[Delete]

Deletes the object you clicked on.

[Duplicate]

Duplicates the object you clicked on.

[Display Order]

Changes the display order of the objects, according to a command in the submenu.

[Recall Scene]

Selects and recalls a scene from the submenu.

[Flash Unit LEDs]

When selected the DME front panel will flash, and will continue flashing until selected a second time.

[Output Level]

When you select this command, the “Output Level” dialog box will be displayed. This sets the DME master volume.

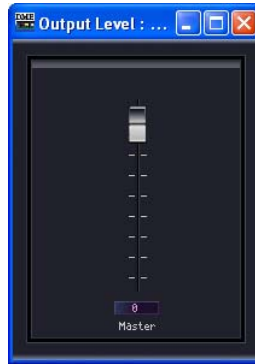

[Properties]

Displays the “DME Device Properties” dialog box.

■ DME Properties

To display the “DME Device Properties” dialog box, select a DME object, then click the [Properties] command on the [Edit] menu. Here you can set DME properties.

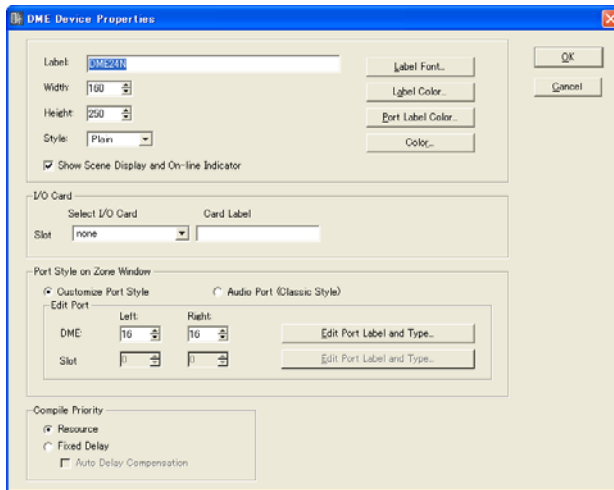

DME24N

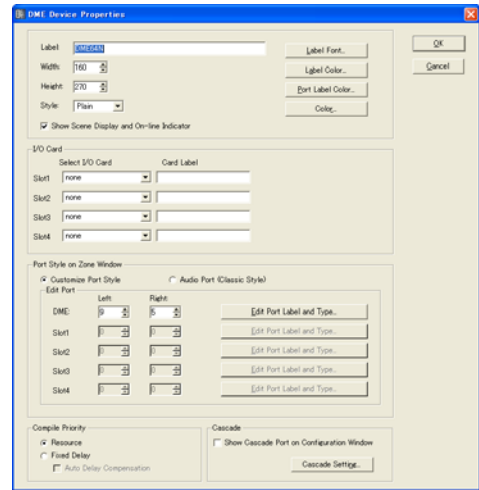

DME64N

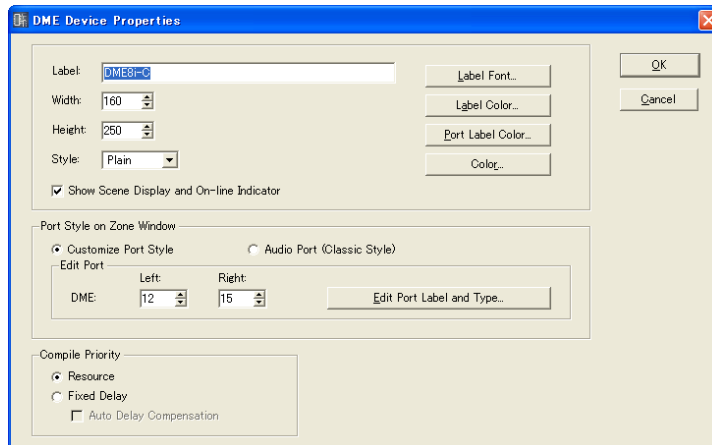

DME Satellite

[Label] Box

You can enter up to 100 English characters to display over the object.

NOTE

The name set in the [Label] box will be displayed on the list in the [Import]/[Export] menu commands, and on the list in the dialog box. If there are multiple examples of the same DME, set different names for each so that you can distinguish one from the other.

[Width] Box

Specifies the width of the object in pixels.

[Height] Box

Specifies the height of the object in pixels.

[Style]

Sets the style of the object. From the list, select [Plain], [Raised], or [Sunken].

[Label Font] Button

Sets the font for the label. Clicking here displays the “Select Font” dialog box. For information about the “Select Font” dialog box, see [page 264](#).

Show Scene Display and On-line Indicator

When checked the current scene number and name and on-line indicator are displayed in the zone window.

[Label Color] Button

This sets the color of the label text. Clicking here displays the “Select Color” dialog box.

[Port Label Color] Button

Sets the color for the I/O port label text. Clicking here displays the “Select Color” dialog box.

[Color] Button

Sets the color of the object. Clicking here displays the “Select Color” dialog box.

NOTE

For information about the “Select Color” dialog box, see [page 265](#).

I/O Card

Allows I/O card setup. [Slot1] ~ [Slot4] can be set up for a DME64N, while only [Slot] is available for a DME24N. No I/O card setup is provided for the DME Satellite.

- **[Select I/O Card]**
Specifies the type of I/O card.
If you are using I/O cards other than Mini-YGDAI cards manufactured by Yamaha, and those cards do not appear in the card list, select [MY-Others].
- **[Card Label]**
I/O card names having up to 100 characters can be entered here.

Port Style On Zone Window

Specifies how the DME ports appear in the zone window.

- **[Custom Port Style]**
Customizes the port display.
 - [Left]**
Sets the number of ports to be displayed on the left.
 - [Right]**
Sets the number of ports to be displayed to the right.
- **[Audio Port (Classic Style)]**
Displays all audio ports.
- **[Edit Port Label and Type]**
Sets the label and type for each port. Click to display the [Edit Port Label] dialog.
→ See “Edit port Label and Type” dialog box on [page 223](#).

Compile Priority

Here you can make compile settings for the configuration.

- **[Resource]**
Compiles arrangeable components in order based on their component numbers. The Delay values differ depending on the signal lines.
- **[Fixed Delay]**
Fixes the Delay value (number of Samples) for the signal lines. However, it also reduces the number of components that can be arranged.

[Auto Delay Compensation]

This turns ON or OFF a function that automatically corrects the component delay when [Fixed Delay] is selected.

NOTE

Auto Delay Compensation will not function properly in configurations that have a loop connection.

Cascade

Turns the DME 64N cascade ON or OFF.

- **Show Cascade Port on Configuration Window**
Checking this enables cascade.
- **[Cascade Setting]**
Here you can make settings that apply when cascade is enabled. Clicking here displays the “Cascade Setting” dialog box.
→ See “Cascade Setting” dialog box on [page 221](#).

[OK] Button

Accepts the changed settings and closes the dialog box.

[Cancel] Button

Closes the dialog box without changing the settings.

■ “Cascade Setting” Dialog Box

Click the [Cascade Setting] button to display the “Cascade Setting” dialog box via which DME64N cascade connections can be verified and edited as required. Make sure that the Head Margin and Mixer I/O settings are the same for multiple cascaded DME64N units. These settings are matched automatically for DME64N units that are connected via their [CAS IN] and [CAS OUT] terminals in the Zone window.

NOTE

Refer to “Cascade (DME64N only)” ([page 489](#)) for input/output and cascade bus assignments.

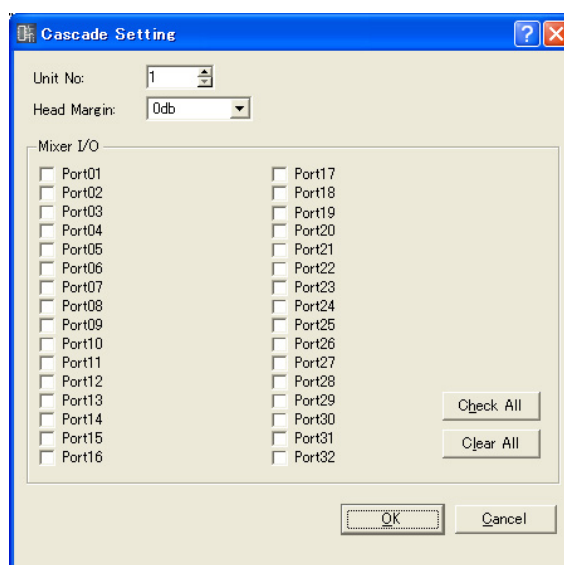

Unit No. (Cascade Connection Number)

These settings automatically produce appropriate delay compensation for cascade-connected DME64N units. When DME64N units are connected via their [CAS IN] and [CAS OUT] terminals in the Zone window, DME64N units other than the first unit (default unit no. 1) are automatically assigned sequential unit numbers. If the number of the first unit is changed the numbers of the other units are automatically changed accordingly. If multiple “first units” exist in the same device group, those first units can all be assigned Unit No. 1. Unit numbers are also automatically assigned for cascade connections that span device groups.

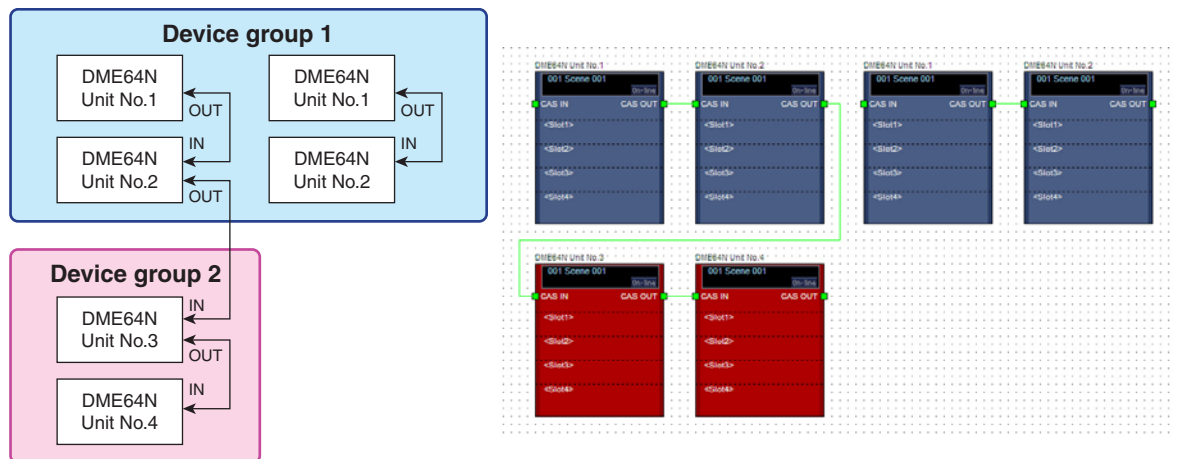
**NOTE**

When multiple DME64N units are cascade connected, each additional unit introduces a delay of a few samples that is automatically compensated for. The Unit No. settings determine the amount of automatic compensation to be applied for each unit.

Head Margin

Sets the CASCADE bus signal head margin. This setting only applies when the unit is cascade connected to a mixer. Since Yamaha provides a CASCADE bus head margin of 18 dB, this parameter should normally be set to "18dB".

The margin for cascade connected DME64N units is always "18dB" regardless of the setting. The head margin settings for DME64N units other than the first unit are automatically set to the same value as the first unit when cascade connections are made, and are thereafter grayed out and can't be changed.

No head margin is provided when a cascade connected PM5D is set up to send the slot output signals via its CASCADE OUT terminal, so the Head Margin parameter must be set to "0dB".

Mixer I/O Channel

Determines whether a direct cascade connection between a DME64N unit and mixer will be bidirectional (bus sharing) or not on a channel-by-channel basis. Make sure that the checkboxes for cascade connected DME64N units are all set the same. The settings are matched automatically when DME64N units are connected via their [CAS IN] and [CAS OUT] terminals in the Zone window.

OFF: The connection with other DME64N units is bus sharing bidirectional. Since the mixer does not support bidirectional connection the connection between the mixer and DME64N unit is unidirectional CASCADE IN -> CASCADE OUT, regardless of the checkbox setting.

ON: The connection with other DME64N units is unidirectional CASCADE IN -> CASCADE OUT. For DME64N units connected between two other DME64N units the connection is internally set to bidirectional, regardless of the checkbox setting.

NOTE

The following settings are made automatically when cascade connections are made, regardless of the checkbox setting.

- DME64N unit between two other DME64N units: bidirectional.
- DME64N between two mixers: unidirectional.
- One mixer connected to one DME64N unit: unidirectional.

[Check All] Button

Checks all checkboxes.

[Clear All] Button

Clears all checkboxes.

[OK] Button

Updates the settings and closes the dialog box.

[Cancel] Button

Closes the dialog box without changing the settings.

“Cascade Setting” Dialog Box Setting Chart

Cascade Destination		DME64N Only	PM5D/DM2000 CASCADE Bus		PM5D Slot Output*	
Head Margin		18dB (automatic)	18dB		0 dB	
Mixer I/O		OFF	ON	OFF	ON	OFF
Signal Direction	②, ③	Always Bidirectional	Unidirectional	Bidirectional	Unidirectional	Bidirectional
	①, ④	—	Always Unidirectional		Always Unidirectional	

* When a cascade connected PM5D is set up to send the slot output signals via its CASCADE OUT terminal.

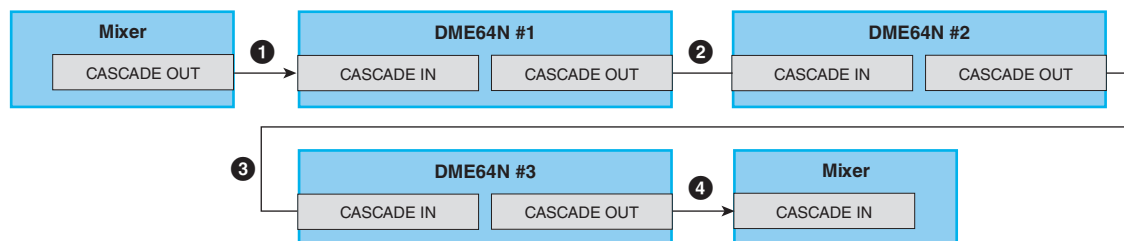

■ Edit Port Label and Type Dialog Box

The Edit Port Label and Type dialog box will appear when the [Edit Port Label and Type] button is clicked. Specifies the port labels and types to be displayed to the left and right of DME and SP2060 objects.

To set labels enter the [Port Name] for [Left] and [Right]. Each name can be up to 100 characters in length.

To set the port type use [Port Type] to select the [Left] and [Right] types.

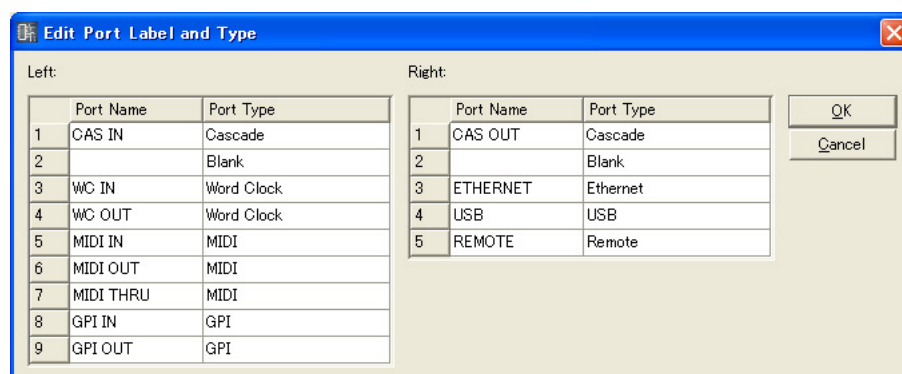

ICP

You can arrange DME Device objects in the Zone window. These can be controlled using User Defined Button.

First click on an ICP object arranged in the Zone window to select it, then double-click the label. This opens a “Control Panel Properties” window. If you right-click on the object, a context menu will be displayed.

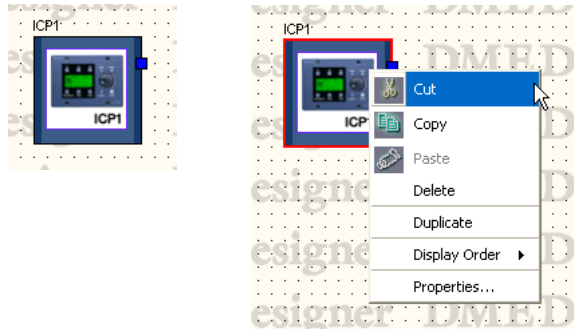

■ ICP Object Context Menu

[Cut]

Cuts the selected object and moves it to the clipboard.

[Copy]

Copies the selected object to the clipboard.

[Paste]

Pastes the control panel object that is on the clipboard. If the same control panel object exists on the sheet where you are pasting, a new ICP object will be created.

[Delete]

Deletes the object you clicked on.

[Duplicate]

Duplicates the object you clicked on.

[Display Order]

Changes the display order of the objects, according to a command in the submenu.

[Properties]

Displays the properties dialog box.

■ ICP Properties

To display the “DME Device Properties” dialog box, select a ICP object, then click the [Properties] command on the [Edit] menu.

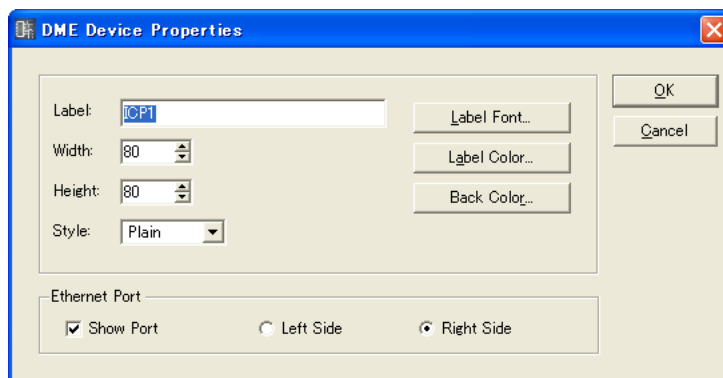

[Label] Box

You can enter up to 100 text characters to display above the object. Labels for identical ICP objects that exist in other configurations will also be changed.

[Width] Box

Specifies the object width in pixels.

[Height] Box

Specifies the object height in pixels.

[Style]

Sets the object style. Select [Plain], [Raised], or [Sunken] from the list.

[Label Font] Button

Sets the font for the label. Clicking here displays the “Select Font” dialog box. For information about the “Select Font” dialog box, see [page 264](#).

[Label Color] Button

This sets the color of the label text. Clicking here displays the “Select Color” dialog box. For information about the “Select Color” dialog box, see [page 265](#).

[Back Color] Button

Sets the object color. Click to display the Select Color dialog box.

Ethernet Port

Turns Ethernet port rendering on or off. Ethernet port display will appear when the checkbox is ON. The radio buttons can be used to specify whether the display is on the left or right side.

[OK] Button

Accepts the changed settings and closes the dialog box.

[Cancel] Button

Closes the dialog box without changing the settings.

SP2060

SP2060 objects can be placed in the zone window. When clicked an SP2060 in the zone window will be selected, and when double-clicked the configuration window will open. A contextual menu will appear if the object is right-clicked.

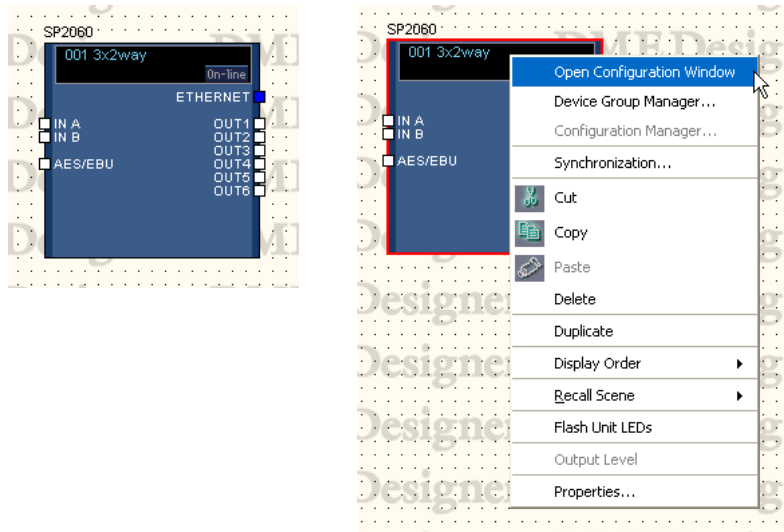

■ Scene Info and [On-line] Button

SP2060 objects include an object that provides scene info and an [On-line] button.

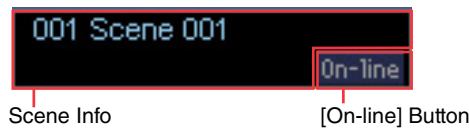

The scene info area displays the current scene number and name. Click the scene info area to open the “Scene Manager” window.

The [On-line] button has the same function as the [On-line] button in the main panel window.

→ “[On-line] Button” ([page 59](#)).

■ The SP2060 Object Context Menu

[Open Configuration Window]

Opens the Configuration window.
→ “Configuration Window” ([page 301](#)).

[Device Group Manager]

Opens the Device Group Manager window
→ See “Device Group Manager” on [page 293](#)

[Configuration Manager]

Not available for SP2060 objects.

[Synchronization]

Opens the “Synchronization” dialog box.
→ See “Synchronization (DME Designer and Unit Synchronization)” on [page 97](#)

[Cut]

Cuts the selected object and places it on the clipboard.

[Copy]

Copies the selected object to the clipboard.

[Paste]

Pastes the SP2060 object currently on the clipboard.

[Delete]

Deletes an object.

[Duplicate]

Creates a duplicate of an object.

[Display Order]

Changes the display order according to the selected submenu command.

[Recall Scene]

Selects and recalls a scene from the submenu.

[Flash Unit LEDs]

Select to flash all indicators on the SP2060 panel. Flashing will continue until this command is de-selected.

[Output Level]

Not available for SP2060 objects.

[Properties]

Opens the "SP2060 Device Properties" window.

■ SP2060 Properties

Select an SP2060 object and click [Properties] in the [Edit] menu to open the “Speaker Processor Device Properties” window. The SP2060 properties can be edited here.

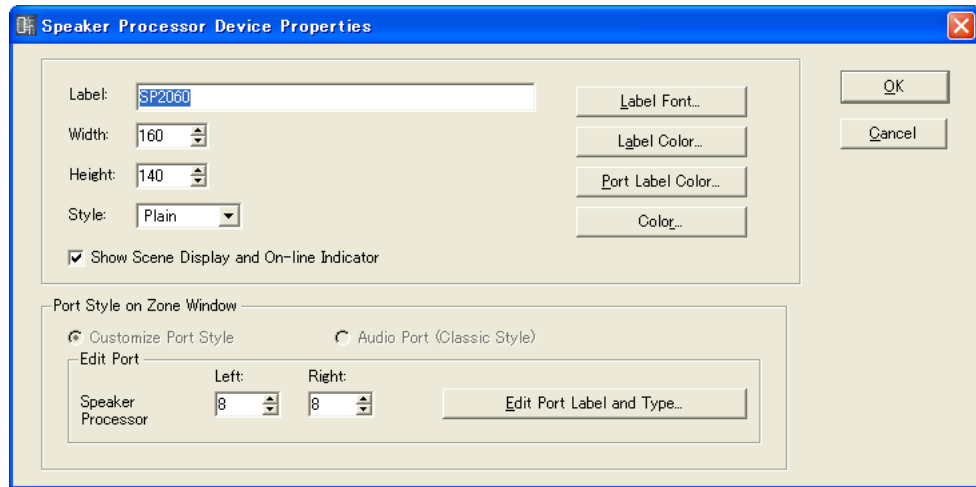

[Label] Box

Up to 100 single-byte characters or 50 two-byte characters can be entered for display on the object. One two-byte character is equivalent to two single-byte characters. Single-byte and two-byte characters can be mixed.

NOTE

The label specified in the [Label] box will appear in the Toolkit window, the [Import] and [Export] menu commands, and window lists. When multiple SP2060 units are used they can be given different labels for easy identification and differentiation.

[Width] Box

Specifies the object width in pixels.

[Height] Box

Specifies the object height in pixels.

[Style]

Specifies the object style: select [Plain], [Raised], or [Sunken] from the list.

Show Scene Display and On-line Indicator

When checked the current scene number and name and on-line indicator are displayed in the zone window.

[Label Font] Button

Specifies the label font. The “Select Font” window will appear when this button is clicked. See “The Select Font Window” on [page 264](#) for details on using the Select Font window.

[Label Color] Button

Specifies the color of the label characters. The “Select Color” window will appear when this button is clicked.

[Port Label Color] Button

Specifies the color of the I/O port label characters. The “Select Color” window will appear when this button is clicked.

[Color] Button

Specifies the color of the object. The “Select Color” window will appear when this button is clicked.

Port Style on Zone Window

Specifies how ports will be displayed on SP2060 objects in the zone window.

[Audio Port (Classic Style)]

Displays all audio ports. This command grayed out and cannot be selected for SP2060 objects.

[Custom Port Style]

Customizes the port display. This setting is always used for SP2060 objects.

- **[Left]**
Specifies the number of ports to be displayed on the left side of the object.
- **[Right]**
Specifies the number of ports to be displayed on the right side of the object.
- **[Edit Port Label and Type]**
Edits the label and type for each port.
The “Edit Port Label and Type” window opens when clicked.
→ “Edit Port Label and Type” window ([page 223](#)).

[OK] Button

Applies the setting changes and closes the window.

[Cancel] Button

Closes the window without changing any settings.

External Device

Arranges external device objects in the Zone window. External applications can be linked to the devices arranged in the window. These links to external applications are set using the “External Device Properties” dialog box.

To start the application linked to an external device object arranged in the Zone window, first click on the object to select it, then double-click it. If you right-click on the object, a context menu will be displayed.

NOTE

If no external application is linked to the an object, no application will start when the object is double-clicked.

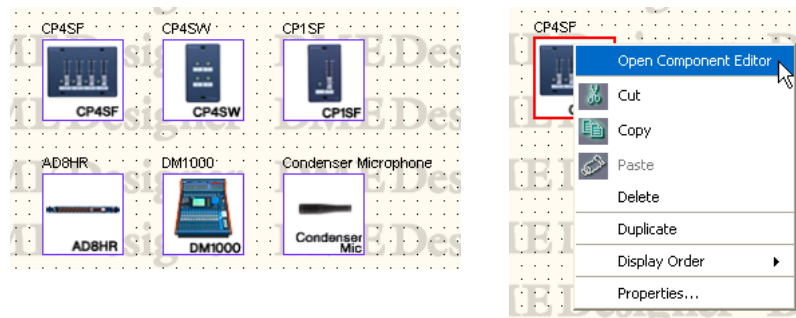

■ AD824/AD8HR

The AD824 is an eight-channel analog-to-digital converter. The AD8HR is an eight-channel analog-to-digital converter that features a head amp with high quality sound.

You can connect Yamaha AD824 and AD8HR A/D converters to a DME unit and control them remotely from DME Designer. DME Designer has a component editor for controlling [AD824] and [AD8HR] units.

If you arrange an [AD824] or [AD8HR] from [External Device] in the Zone window, select the connected DME unit in the properties dialog box, and double-click on an [AD824] or [AD8HR] block, the component editor is displayed.

NOTE

If a DME is not selected in the properties dialog box, the component editor will not be displayed even if you double-click.

■ External Device Object Context Menu

[Open Component Editor]

Starts the application assigned to the object.
For the [AD824] and [AD8HR], it opens the component editor.

[Cut]

Cuts the selected object and moves it to the clipboard.

[Copy]

Copies the selected object to the clipboard.

[Paste]

Pastes the object that is on the clipboard.

[Delete]

Deletes the object you clicked on.

[Duplicate]

Duplicates the object you clicked on.

[Display Order]

Changes the display order of the objects, according to a command in the submenu.

[Properties]

Displays the “External Device Properties” dialog box.
At the lowest position below [External Device], [AD824] and [AD8HR] display the “Serial Controlled Device Properties” dialog box. The other objects display the “External Device Properties” dialog box.

External Device Properties

To display the “External Device Properties” dialog box, select any external device object besides AD824 or AD8HR, then click the [Properties] command on the [Edit] menu.

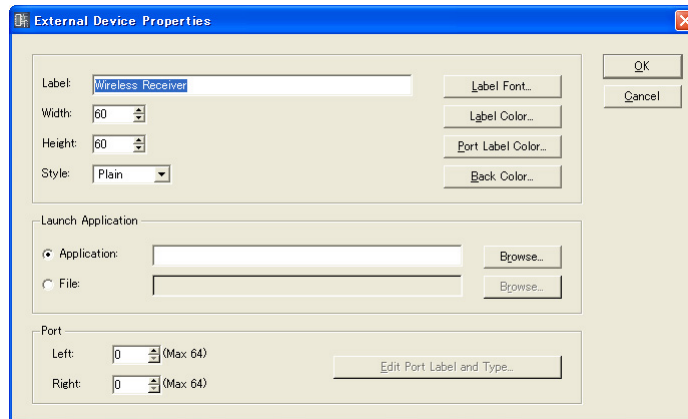

[Label] Box

You can enter up to 100 English characters to display over the object.

[Width] Box

Specifies the object width in pixels.

[Height] Box

Specifies the object height in pixels.

[Style]

Sets the object style. Select [Plain], [Raised], or [Sunken] from the list.

[Label Font] Button

Sets the font for the label. Clicking here displays the “Select Font” dialog box. For information about the “Select Font” dialog box, see [page 264](#).

[Label Color] Button

This sets the color of the label text. Clicking here displays the “Select Color” dialog box.

[Port Label Color] Button

Sets the color of the I/O port label. Click to display the Select Color dialog box.

[Back Color] Button

Sets the object color. Click to display the Select Color dialog box.

NOTE

For information about the “Select Color” dialog box, see [page 265](#).

Launch Application

The radio buttons determines whether an application or file will be linked to an external device.

- **[Application] Box**

The linked application will be displayed. Click the [Browse] button to locate and select an application. Specifies the path to an application to be launched when an External Device object is double-clicked.

- **[File] Box**

The linked file will be displayed. Click the [Browse] button to locate and select a file. Specifies the path to a file to be launched when an External Device object is double-clicked.

Port

Specifies the number of ports displayed for an External Device object.

- **[Left]**

Sets the number of ports to be displayed on the left.

- **[Right]**

Sets the number of ports to be displayed to the right.

- **[Edit Port Label and Type...] Button**

Sets the label and type for each port. Click to display the [Edit Port Label] dialog box.

[OK] Button

Accepts the changed settings and closes the dialog box.

[Cancel] Button

Closes the dialog box without changing the settings.

■ External Device Properties (AD824, AD8HR “Serial Controlled Device Properties” Dialog Box)

To display the “Serial Controlled Device Properties” dialog box, select AD824 or AD8HR, then click the [Properties] command on the [Edit] menu.

This dialog box is the same as the “External Device Properties” dialog box, except for [Remote].

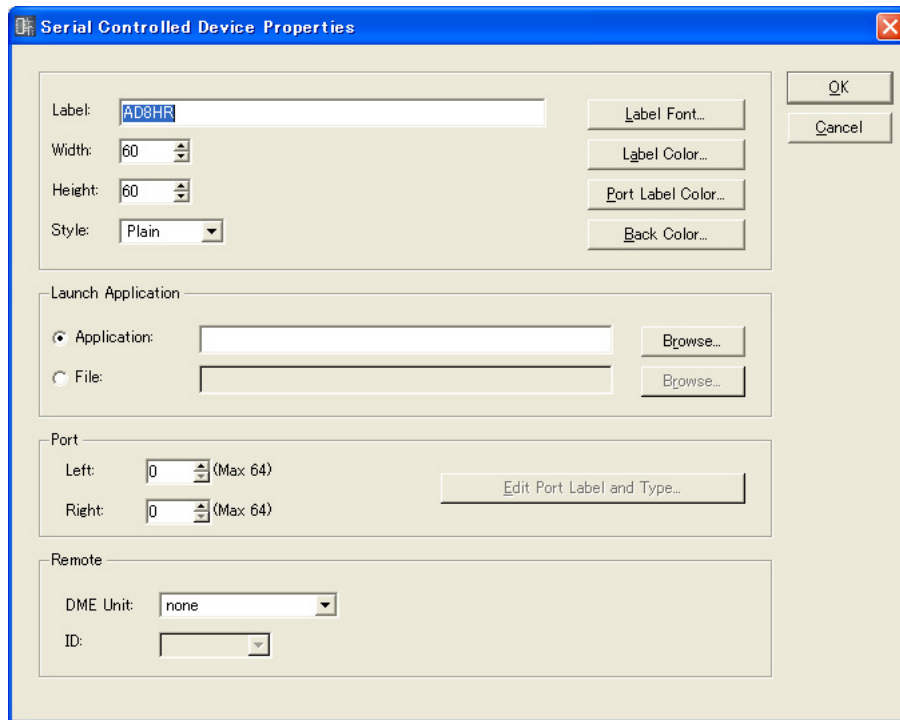

Remote

Select the DME to control remotely AD824 and AD8HR.

- **[DME Unit]**
The DMEs in the current configuration will be displayed in a list. Select the DME you will control remotely.
- **[ID]**
Selects an ID from 1 to 8. The default is 1.
AD824 and/or AD8HR units will be assigned beginning from “1” in the order that they are connected. When combining AD824 and AD8HR units it is necessary to connect AD8HR units before AD824 units.

Component

Components are arranged in the Configuration window and the User Module window. They include audio processors like mixers and compressors, and control parts like switches and sliders.

Component objects arranged in a configuration are displayed in block form.

To open the component editor for an arranged component, first select it by clicking on it, then double-click on it. If you right-click on the object, a context menu will be displayed.

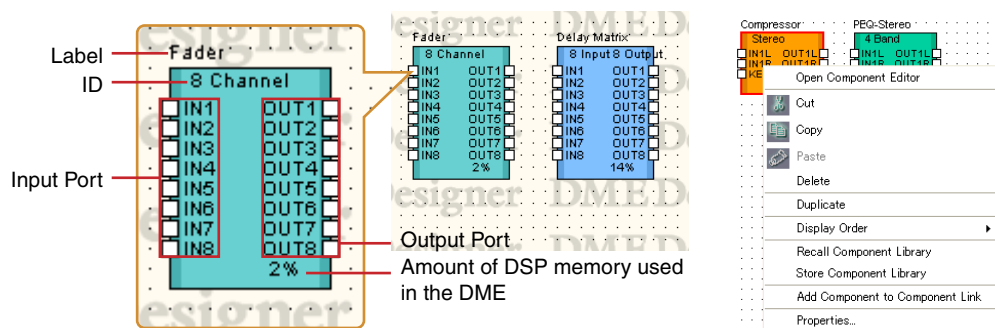

NOTE

The amount of DSP memory used is not displayed for SP2060 units.

■ Component Object Context Menu

[Open Component Editor]

Opens the component editor.

[Cut]

Cuts the selected object and moves it to the clipboard.

[Copy]

Copies the selected object to the clipboard.

[Paste]

Pastes the object that is on the clipboard.

[Delete]

Deletes the object you clicked on.

[Duplicate]

Duplicates the object you clicked on.

[Display Order]

Changes the display order of the objects, according to a command in the submenu.

[Recall Component Library]

Recalls libraries with component parameters saved in them. Clicking here displays the submenu. When a library is selected from the submenu, the library is read and the component parameters are changed.

For more information about libraries, see “Library” (page 364).

NOTE

Libraries can be recalled only by users for whom [Control Component Editor] in security is turned ON. The command is grayed out for users for whom [Control Component Editor] is turned OFF.

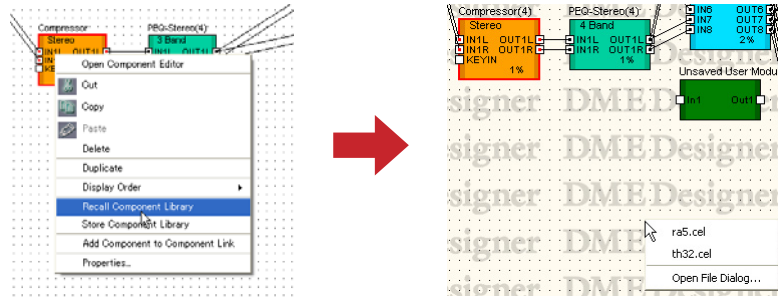

• **[Open File Dialog]**

Displays the file select dialog box. You can recall libraries saved in folders other than the user module “Library” folder.

[Store Component Library]

Saves the component parameters. Click to display the “Store” dialog box. If you then save without changing the folder, the parameters will be added to the library. Refer to “Library” on page 364 for more information.

[Add Component to Component Link]

Creates component link. Refer to “Creating Component Links” on page 370 for more information.

[Properties]

Displays the “Component Properties” dialog box.

■ **Component Properties**

Here you can set properties for each component. If multiple examples of the same component type are arranged on a single sheet, changing the properties of a single component does not change the others.

To display the “Component Properties” dialog box, select a component object, then click the [Properties] command on the [Edit] menu.

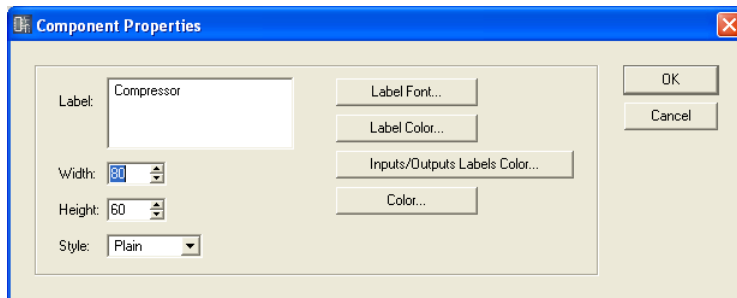

[Label] Box

You can enter up to 100 English characters to display over the object.

[Width] Box

Specifies the width of the object in pixels.

[Height] Box

Specifies the height of the object in pixels.

[Style]

Sets the style of the object. From the list, select [Plain], [Raised], or [Sunken].

[Label Font] Button

Sets the font for the label. Clicking here displays the “Select Font” dialog box. For information about the “Select Font” dialog box, see [page 264](#).

[Label Color] Button

This sets the color of the label text. Clicking here displays the “Select Color” dialog box.

[Inputs/Outputs Label Color] Button

Sets the color for the I/O port label text. Clicking here displays the “Select Color” dialog box.

[Color] Button

Sets the color of the object. Clicking here displays the “Select Color” dialog box.

NOTE

For information about the “Select Color” dialog box, see [page 265](#).

[OK] Button

Accepts the changed settings and closes the dialog box.

[Cancel] Button

Closes the dialog box without changing the settings.

SPX Component

SPX components are arranged in the Configuration window and the User Module window. Component objects arranged in a configuration are displayed in block form.

Clicking on a positioned SPX component will select it, and right-clicking will display a contextual menu.

Unlike normal components, SPX components use SPX-specific resources and therefore the usage percentage display that appears to the lower right of normal components will not appear. Check the SPX resource usage percentage via the SPX meter in the Resource Meter window.

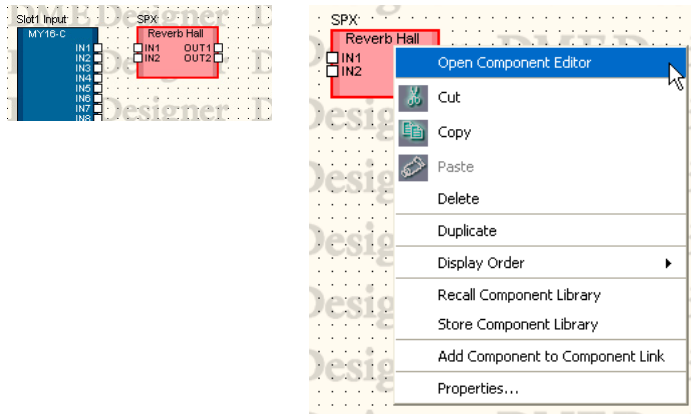

■ Context Menu for SPX Component Objects

[Open Component Editor]

Opens the component editor.

[Cut]

Cuts the selected object and moves it to the clipboard.

[Copy]

Copies the selected object to the clipboard.

[Paste]

Pastes the object that is on the clipboard.

[Delete]

Deletes the object you clicked on.

[Duplicate]

Duplicates the object you clicked on.

[Display Order]

Changes the display order of the objects, according to a command in the submenu.

[Recall Component Library]

Recalls libraries with component parameters saved in them. Clicking here displays the submenu. When a library is selected from the submenu, the library is read and the component parameters are changed.

For more information about libraries, see “Library” ([page 364](#)).

When you will change the effect type for the SPX component, select the desired type from the [Effect Type] displayed in the submenu.

NOTE

Libraries can be recalled only by users for whom [Control Component Editor] in security is turned ON. The command is grayed out for users for whom [Control Component Editor] is turned OFF.

[Store Component Library]

Saves the component parameters. Click to display the “Store” dialog box. If you then save without changing the folder, the parameters will be added to the library. Refer to “Library” on [page 364](#) for more information.

[Add Component to Component Link]

This menu has no effect for SPX components.

[Properties]

Displays the “SPX Component Properties” dialog box.

■ SPX Component Properties

SPX component properties are set for each component. If multiple examples of the same component type are arranged on a single sheet, changing the properties of a single component does not change the others.

To display the “SPX Component Properties” dialog box, select a component object, then click the [Properties] command on the [Edit] menu.

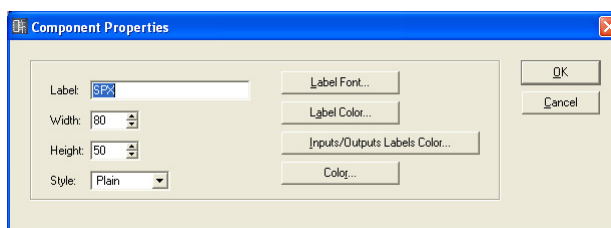
**[Label] Box**

You can enter up to 100 characters to display over the object.

[Width] Box

Specifies the width of the object in pixels.

[Height] Box

Specifies the height of the object in pixels.

[Style]

Sets the style of the object. From the list, select [Plain], [Raised], or [Sunken].

[Label Font] button

Sets the font for the label. Clicking here displays the “Select Font” dialog box. For information about the “Select Font” dialog box, see “Select Font” dialog box ([page 264](#)).

[Label Color] Button

Sets the color for the label text. Clicking here displays the “Select Color” dialog box.

[Inputs/Outputs Label Color] Button

Sets the color for the I/O port label text. Clicking here displays the “Select Color” dialog box.

[Color] Button

Sets the color of the object. Clicking here displays the “Select Color” dialog box.

NOTE

For information about the “Select Color” dialog box, see “‘Select Color’ Dialog Box” ([page 265](#)).

[OK] Button

Updates the settings and closes the dialog box.

[Cancel] Button

Closes the dialog box without changing the settings.

Slot Component

If an inserted I/O card is selected in the DME properties settings, it will be displayed in the Configuration window as a Slot component.

Slot component objects arranged in a configuration are displayed in block form.

If you select an arranged component by clicking on it, then double-click it, the component editor opens. If you right click on the object, a context menu will be displayed.

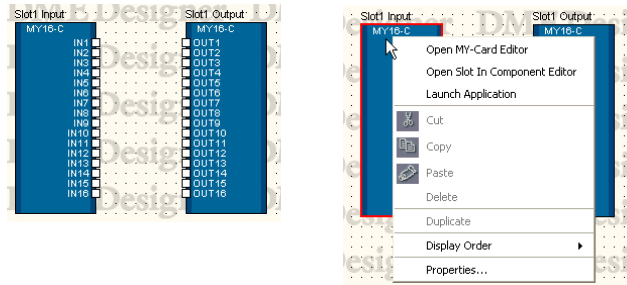

■ Slot Component Object Context Menu

[Open MY-Card Editor]/[Open HA Editor]/[Open CobraNet Editor]

Opens the editor for Slot components.

[Open Slot In Component Editor]/ [Open Slot Out Component Editor]/[Open Input Component Editor]/[Open Output Component Editor]

Opens the component editor.

[Launch Application]

Launches linked application.

[Cut]/[Copy]/[Paste]/[Delete]/[Duplicate]

The functions cannot be used with Slot components.

[Display Order]

Changes the display order of the objects, according to a command in the submenu.

[Properties]

Displays the “Component Properties” dialog box.

■ Slot Component Properties

To display the “Slot Component Properties” dialog box, select a Slot component object, then click the [Properties] command on the [Edit] menu.

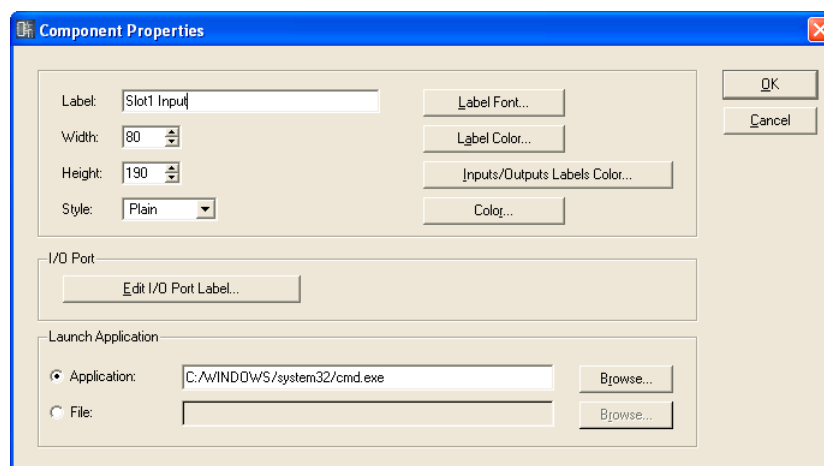

[Label] Box

You can enter up to 100 characters to display over the object.

[Width] Box

Specifies the width of the object in pixels.

[Height] Box

Specifies the height of the object in pixels.

[Style]

Sets the style of the object. From the list, select [Plain], [Raised], or [Sunken].

[Label Font] button

Sets the font for the label. Clicking here displays the “Select Font” dialog box. For information about the “Select Font” dialog box, see “‘Select Font’ Dialog Box” ([page 264](#)).

[Label Color] Button

This sets the color of the label text. Clicking here displays the “Select Color” dialog box.

[Inputs/Outputs Label Color] Button

Sets the color for the I/O port label text. Clicking here displays the “Select Color” dialog box.

[Color] Button

Sets the color of the object. Clicking here displays the “Select Color” dialog box.

NOTE

For information about the “Select Color” dialog box, see “‘Select Color’ Dialog Box” ([page 265](#)).

[Edit I/O Port Label] Button

Specifies the I/O port label. The “Edit Port Label” window opens when this button is clicked. → “Edit Port Label” Dialog box ([page 242](#))

Launch Application

Click the radio button and select whether an application or file is to be linked to the Slot component.

- **[Application] Box**

Shows the linked application. Click the [Browse] button to browse and select an application. Set the path of the application to be launched from the Slot component contextual menu.

- **[File]**

Shows the linked file. Click the [Browse] button to browse and select a file. Set the path of the file to be opened from the Slot component contextual menu.

[OK] Button

Updates the settings and closes the dialog box.

[Cancel] Button

Closes the dialog box without changing the settings.

■ “Edit Port Label” Dialog Box

When you click the [Edit I/O Port Label] button, the “Edit Port Label” dialog box is displayed. Here you can set the port labels displayed for components. Enter a [Short Name] and [Long Name]. You can enter up to 100 English characters for each name. If you click the [Use default names] button, all port labels return to the default settings.

You can switch between long and short port names displayed in the configuration window with the [Port Long Name] command in the [View] menu. When you select this command, a checkmark appears next to it and long names are displayed. If you select this command while a checkmark is next to it, the checkmark disappears and short names are displayed.

Labels specified here are always displayed in the Configuration Window.

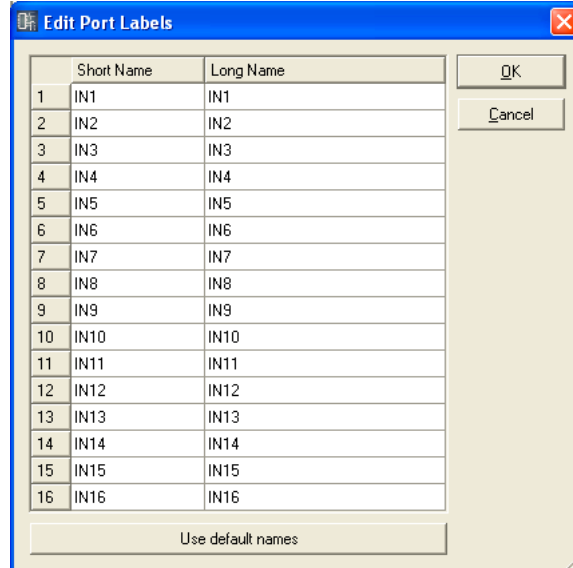

User Module

A user module combines a number of other components into a module that is treated as a single component. It can be arranged in the Configuration window. A user object arranged in a window is displayed as a single block. The User Module Design Window or User Module Window will open, according to the “Double Click Action” setting of “User Module Properties” dialog box when you double click the user module (page 314).

If you right-click on the object, a context menu will be displayed.

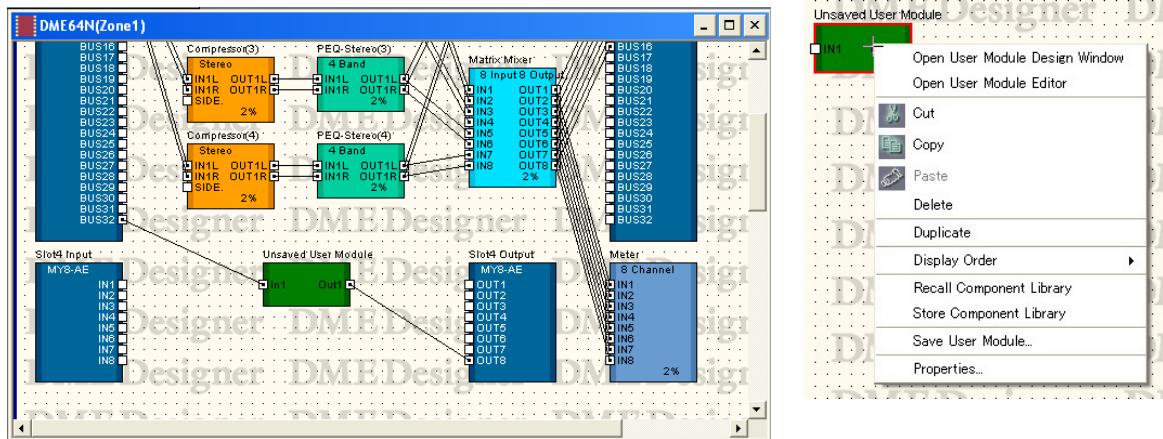

■ User Module Object Context Menu

[Open User Module Design Window]

Opens the User Module Design Window.

[Open User Module Editor]

Opens the User Module Editor.

[Cut]

Cuts the selected object and moves it to the clipboard.

[Copy]

Copies the selected object to the clipboard.

[Paste]

Pastes the object that is on the clipboard.

[Delete]

Deletes the object you clicked on.

[Duplicate]

Duplicates the object you clicked on.

[Display Order]

Changes the display order of the objects, according to a command in the submenu.

[Recall Component Library]

Recalls a library into which component parameters have been saved. Click to display a sub-menu. Select a library from the sub-menu to load the parameters into the component. Refer to “Library” on [page 364](#) for more information.

NOTE

Libraries can be recalled only by users for whom [Control Component Editor] in security is turned ON. The command is grayed out for users for whom [Control Component Editor] is turned OFF.

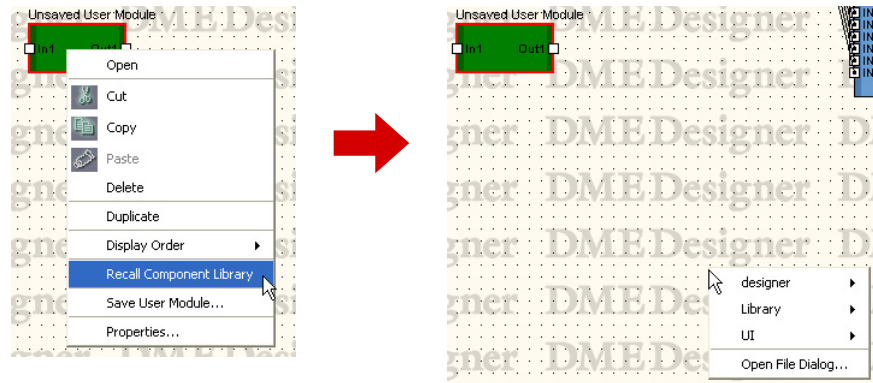

- **[Open File Dialog]**

Displays the file select dialog box. You can recall libraries saved in folders other than the user module “Library” folder.

[Store Component Library]

Saves the component parameters. Click to display the “Store” dialog box. If you then save without changing the folder, the parameters will be added to the library. Refer to “Library” on [page 364](#) for more information.

[Save User Module]

Saves the selected user module. See “Saving User Modules” on [page 310](#).

[Properties]

Displays the “User Module Properties” dialog box.

■ User Module Properties

To display the “User Module Properties” dialog box, select a user module object, then click the [Properties] command on the [Edit] menu.

NOTE

The “User Module Properties” dialog box is also displayed when a [Blank User Module] is arranged in the configuration window.

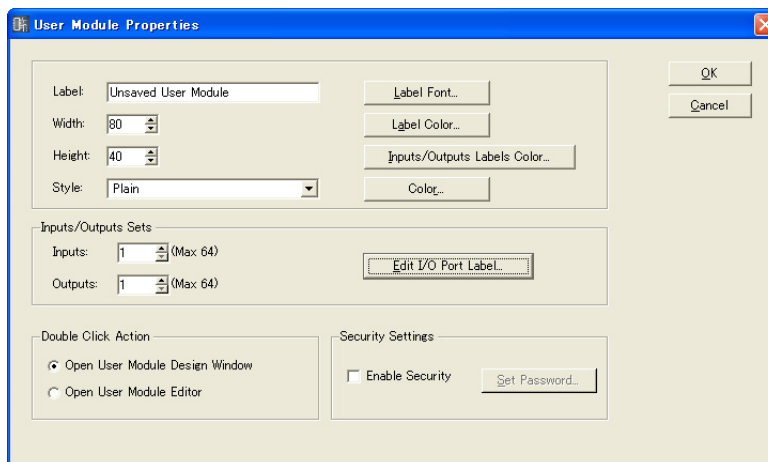

[Label] Box

You can enter up to 100 English characters to display over the object.

[Width] Box

Specifies the width of the object in pixels.

[Height] Box

Specifies the height of the object in pixels.

[Style]

Sets the style of the object. From the list, select [Plain], [Raised], [Sunken], or [Image]. When [Image] is selected the “Open” dialog box will appear. Select an image file and click [Open] to place the selected image as an object.

[Label Font] Button

Sets the font for the label. Clicking here displays the “Select Font” dialog box. For information about the “Select Font” dialog box, see [page 264](#).

[Label Color] Button

This sets the color of the label text. Clicking here displays the “Select Color” dialog box.

[Inputs/Outputs Labels Color] Button

Sets the color for the I/O port label text. Clicking here displays the “Select Color” dialog box.

[Color] Button

Sets the color of the object. Clicking here displays the “Select Color” dialog box.

NOTE

For information about the “Select Color” dialog box, see [page 265](#).

Inputs/Outputs Sets

Sets the number of input/output ports. Enter a number into the [Inputs] box and [Outputs] box, or set a value using the [▲] and [▼] buttons at the right of each box. The maximum of both input and output ports is 64.

Edit I/O Port Label

Input and output port names up to 100 characters in length can be entered.

Double-Click Action

Sets the action that occurs when you double-click on a user module object arranged in the Configuration window.

- **[Open User Module Design Window]**
Opens the User Module window.
- **[Open User Module Editor]**
Opens the User Module editor.

Security Settings

Turns user module security ON or OFF, and sets a password.

- **[Enable Security]**
Enables user module security. If you turn this function ON when no password is currently set, the “Set Password” dialog box appears. Enter a password, then click the [OK] button.

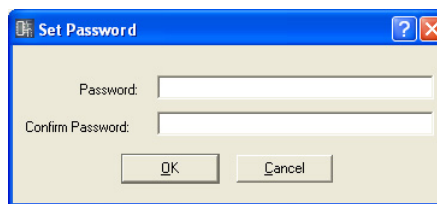

If you change the setting from OFF to ON, the “Input Password” dialog box appears. You cannot turn Security OFF until you enter the correct password.

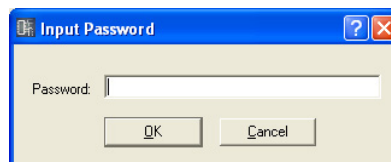

NOTE

When security is active the editor cannot be opened unless the appropriate password is entered. Once the password has been entered security is temporarily disabled until the DME Designer is quit, or a different file is opened.

- **[Set Password] Button**
Changes the password for user modules. Clicking this button displays the “Input Password” dialog box. Enter the current password and click the [OK] button. The “Set Password” dialog box will be displayed, and you can set a new password.
This button will be grayed out when [Enable Security] is turned OFF.

[OK] Button

Accepts the changed settings and closes the dialog box.

[Cancel] Button

Closes the dialog box without changing the settings.

Picture

An image can be arranged as an object on a sheet. This specifies a file for this purpose. You can use image files in the following formats: BMP (.bmp), PNG (.png), XBM (.xbm), XPM (.xpm), and JPEG (.jpg).

Before placing a picture object, prepare an image file. Copy the image file to the folder specified in the “Preferences” dialog box → [Application] tab → [ContentsFolder] in the Main Panel window.

In the project file, the location and name of the image file are registered in an relative path below the [ContentsFolder] and the linked image file is read and displayed. If the image file is moved, renamed, or the [ContentsFolder] is changed, the image cannot be displayed.

NOTE

Background images for sheets are specified in the “Sheet” dialog box. Pictures are arranged as objects on the sheets.

■ Placing Pictures

There are three picture placement methods:

- You can drop the [Picture] item from the Toolkit window into each design window.
- You can double-click [Picture] on the Toolkit window.
- You can click [Picture] in the [Area Parts]/[Device List]/[Component List] on the [Tools] menu, then click each design window.

When you place a picture object, the “Open” dialog box is displayed. Select the image file and click the [Open] button. The picture will be placed in the design window.

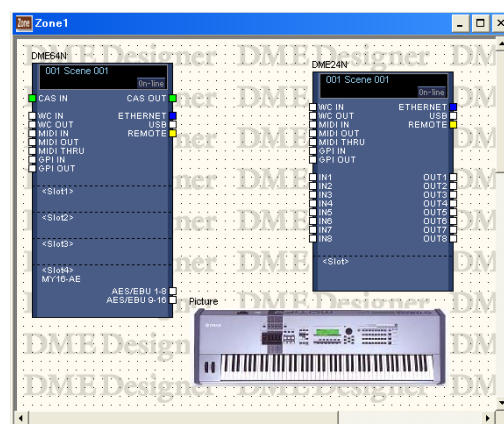
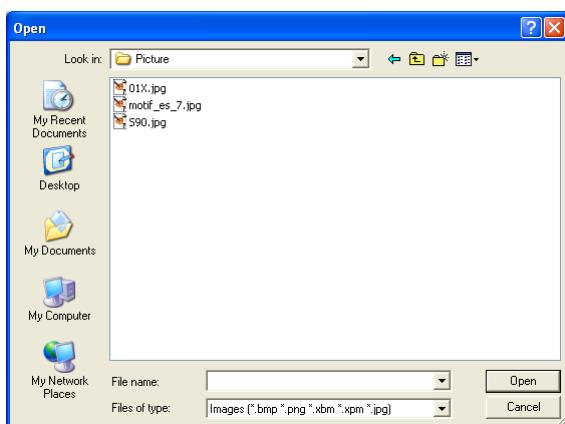

■ Picture Object

When you click a picture object that is located in each design window, handles (small squares) appear at the corners and sides of the object. You can expand or reduce the picture's size by dragging a handle.

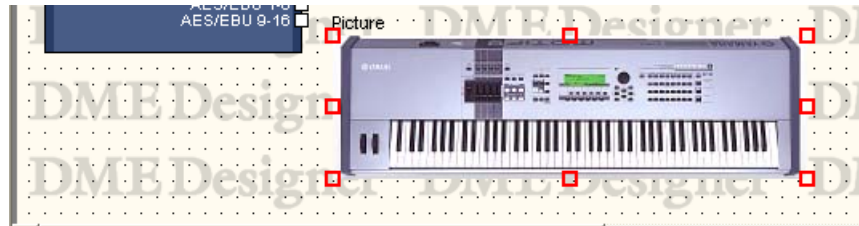

If you double-click on the object, the "Picture Properties" dialog box opens. If you right-click on a picture object, a context menu will be displayed.

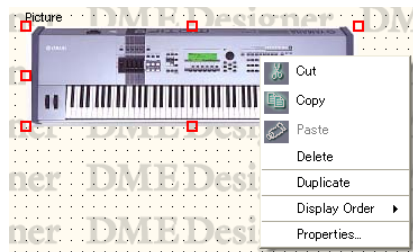

■ Picture Module Object Context Menu

[Cut]

Cuts the selected object and moves it to the clipboard.

[Copy]

Copies the selected object to the clipboard.

[Paste]

Pastes the object that is on the clipboard.

[Delete]

Deletes the object you clicked on.

[Duplicate]

Duplicates the object you clicked on.

[Display Order]

Changes the display order of the objects, according to a command in the submenu.

[Properties]

Displays the "Picture Properties" dialog box.

■ Picture Object Properties

To display the “Picture Properties” dialog box, select a picture object, then click the [Properties] command on the [Edit] menu.

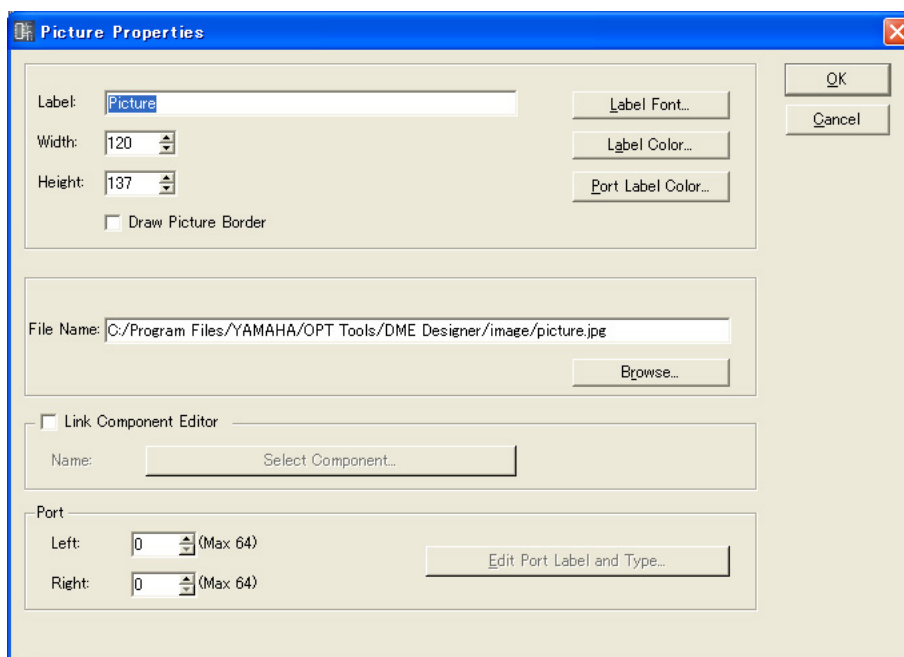

[Label] Box

You can enter up to 100 English characters to display over the object. If the box is left blank, the label will disappear.

[Draw Picture Border]

Displays a border around picture objects.

[Label Font] Button

Sets the font for the label. Clicking here displays the “Select Font” dialog box. For information about the “Select Font” dialog box, see [page 264](#).

[Label Color] Button

This sets the color of the label text. Clicking here displays the “Select Color” dialog box. For information about the “Select Color” dialog box, see [page 265](#).

[Port Label Color] Button

Sets the color of the I/O port label. Click to display the Select Color dialog box.

[File Name] Box

Displays the path to the graphic file.

[Browse] Button

Selects a graphic file.

[Link Component Editor]

When On a Picture object can be double clicked to open the component editor specified by the [Select Component] button. If an object is placed in the Configuration Window and the Link Component Editor is not active, Picture Properties will be displayed. This only affects the object that has been placed in the Configuration Window. All others will be grayed out and cannot be selected.

[Select Component] Button

Specifies the component editor to be opened when a Picture object is double clicked. Only effective when [Link Component editor] is On.

Port

Specifies the number of ports to be displayed for a picture object.

- **[Left]**
Sets the number of ports to be displayed on the left.
- **[Right]**
Sets the number of ports to be displayed to the right.
- **[Edit Port Label and Type...] Button**
Sets the label and type for each port. Click to display the [Edit Port Label] dialog box.

[OK] Button

Accepts the changed settings and closes the dialog box.

[Cancel] Button

Closes the dialog box without changing the settings.

Text Box

Text objects can be arranged in all design windows. Text is entered into the “Text Properties” dialog box. When first placed in the design window, the word “Text” is entered into the box. If you click the text object, handles (small squares) appear at the corners and sides of the object. You can adjust the size by dragging the handles. You can open the “Text Properties” dialog box by double-clicking the box. If you right-click on the object, a context menu will be displayed.

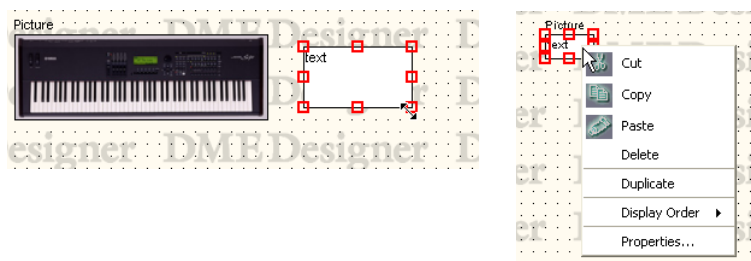

■ Text Object Context Menu

[Cut]

Cuts the selected object and moves it to the clipboard.

[Copy]

Copies the selected object to the clipboard.

[Paste]

Pastes the object that is on the clipboard.

[Delete]

Deletes the object you clicked on.

[Duplicate]

Duplicates the object you clicked on.

[Display Order]

Changes the display order of the objects, according to a command in the submenu.

[Properties]

Displays the “Text Properties” dialog box.

■ Text Object Properties

To display the “Text Properties” dialog box, double-click on a text object, or select a text object, then click the [Properties] command on the [Edit] menu.

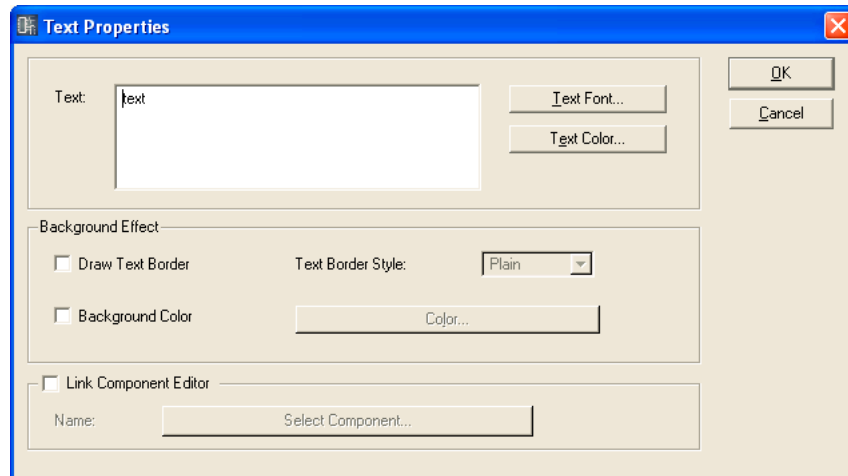

[Text] Box

You can enter up to 10,000 English characters to display in the text object box.

[Text Font] Button

Sets the font. Clicking here displays the “Select Font” dialog box. For information about the “Select Font” dialog box, see [page 264](#).

[Text Color] Button

Sets the color of the text. Clicking here displays the “Select Color” dialog box.

[Draw Text Border]

Displays a frame around the text object. If this is not checked, only the text will be displayed on the sheet.

[Text Border Style] Box

Sets the style of the object. From the list, select [Plain], [Raised], or [Sunken].

[Background Color]

Uncheck this item to make the background of text objects transparent. When this item is checked the [Color] button to its right opens the “Select color” dialog box that can be used to select a background color.

NOTE

For information about the “Select Color” dialog box, see [page 265](#).

[Link Component Editor]

When On a Text object can be double clicked to open the component editor specified by the [Select Component] button. If an object is placed in the Configuration Window and the Link Component Editor is not active, Text Properties will be displayed. This only affects the object that has been placed in the Configuration Window. All others will be grayed out and cannot be selected.

[Select Component] Button

Specifies the component editor to be opened when a Text object is double clicked. Only effective when [Link Component editor] is On.

[OK] Button

Accepts the changed settings and closes the dialog box.

[Cancel] Button

Closes the dialog box without changing the settings.

Box (Rectangle)

You can arrange rectangles on the sheet.

If you click the box, handles (small squares) appear at the corners and sides of the object. You can adjust the size by dragging the handles. You can open the “Box Properties” dialog box by double-clicking the box. If you right-click on the object, a context menu will be displayed.

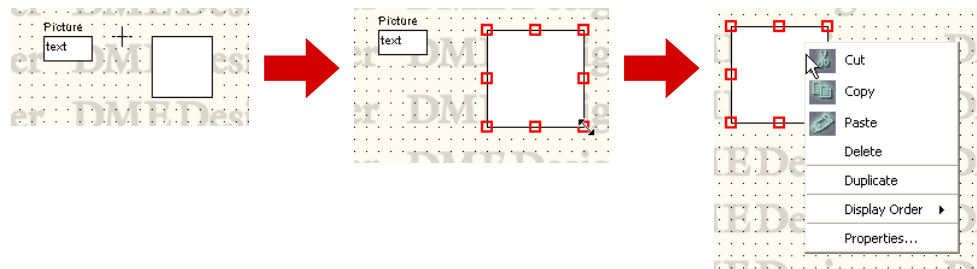

■ Box Object Context Menu

[Cut]

Cuts the selected object and moves it to the clipboard.

[Copy]

Copies the selected object to the clipboard.

[Paste]

Pastes the object that is on the clipboard.

[Delete]

Deletes the object you clicked on.

[Duplicate]

Duplicates the object you clicked on.

[Display Order]

Changes the display order of the objects, according to a command in the submenu.

[Properties]

Displays the “Box Properties” dialog box.

■ Box Object Properties

To display the “Box Properties” dialog box, double-click on a box object or select a box object, then click the [Properties] command on the [Edit] menu.

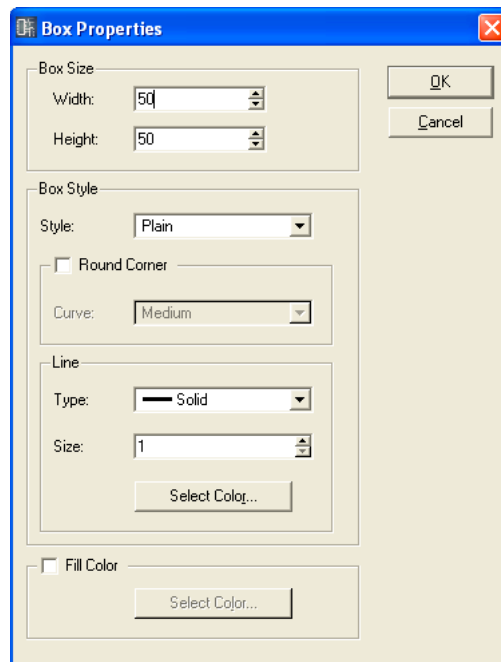

[Width] Box

Specifies the width of the object in pixels. The default is 50 pixels.

[Height] Box

Specifies the height of the object in pixels. The default is 50 pixels.

[Style]

Sets the style of the object. From the list, select [Plain], [Raised], or [Sunken].

[Round Corner]

Creates a rectangular box with rounded corners.

Line

Sets the line that frames the box.

- **[Type]**
Displays a list where you can select the type of line to frame the box. The following types are available: [Solid], [Dash], [Dot], [DashDot], and [DashDotDot].
- **[Size] Box**
Sets the width of the line that frames the box. This setting can range from 1 to 100 pixels.
- **[Select Color] Button**
Sets the color of the line that frames the box. Clicking here displays the “Select Color” dialog box.
For information about the “Select Color” dialog box, see [page 265](#).

[Fill Color]

Uncheck this item to make the background of objects transparent. When this item is checked the [Color] button opens the “Select color” dialog box that can be used to select a background color.

[OK] Button

Accepts the changed settings and closes the dialog box.

[Cancel] Button

Closes the dialog box without changing the settings.

Ellipse

[Ellipse] in the Toolkit window places an elliptical shape on the sheet.

When you click an Ellipse object that is located in the sheet, handles (small squares) appear at the corners and sides of the object. You can adjust the size by dragging the handles. You can open the “Ellipse Properties” dialog box by double-clicking the ellipse. If you right-click on the object, a context menu will be displayed.

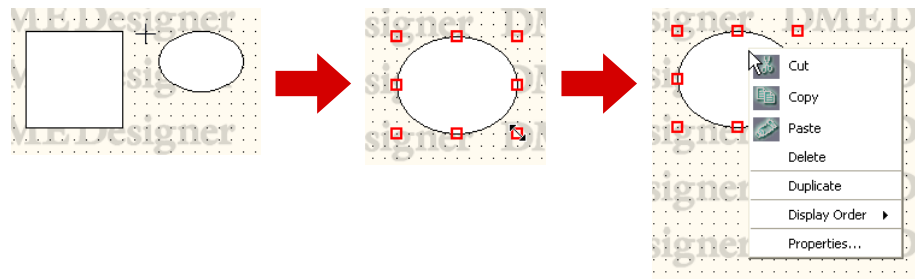

■ Ellipse Object Context Menu

[Cut]

Cuts the selected object and moves it to the clipboard.

[Copy]

Copies the selected object to the clipboard.

[Paste]

Pastes the object that is on the clipboard.

[Delete]

Deletes the object you clicked on.

[Duplicate]

Duplicates the object you clicked on.

[Display Order]

Changes the display order of the objects, according to a command in the submenu.

[Properties]

Displays the “Ellipse Properties” dialog box.

■ Ellipse Object Properties

To display the “Ellipse Properties” dialog box, double-click on an ellipse object, or select an ellipse object, then click the [Properties] command on the [Edit] menu.

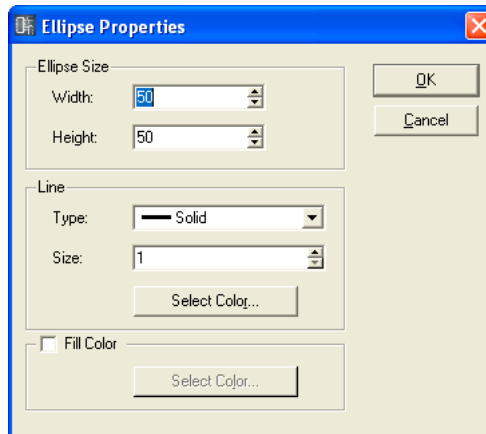

[Width] Box

Specifies the width of the object in pixels. The default is 50 pixels.

[Height] Box

Specifies the height of the object in pixels. The default is 50 pixels.

Line

Sets the line that frames the ellipse.

- **[Type]**
Displays a list where you can select the type of line to frame the ellipse. The following types are available: [Solid], [Dash], [Dot], [DashDot], and [DashDotDot].
- **[Size] Box**
Sets the width of the line that frames the ellipse. This setting can range from 1 to 100 pixels.
- **[Select Color] Button**
Sets the color of the line that frames the ellipse. Clicking here displays the “Select Color” dialog box.
For information about the “Select Color” dialog box, see [page 265](#).

[Fill Color]

Uncheck this item to make the background of objects transparent. When this item is checked the [Color] button opens the “Select color” dialog box that can be used to select a background color.

[OK] Button

Accepts the changed settings and closes the dialog box.

[Cancel] Button

Closes the dialog box without changing the settings.

Wire

Draws lines (wires) for connecting components and creating shapes. For instructions on drawing wires, see [“Drawing and Editing Wires” on page 279](#).

First click on an wire object arranged on the sheet to select it, then double-click the object. This opens a “Wire Properties” window.

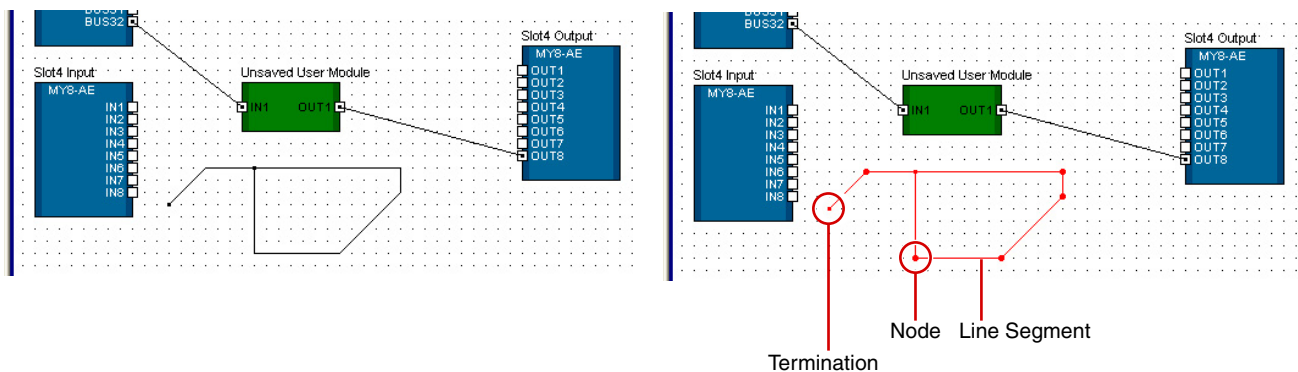

If you right-click on a wire object, one of three types of context menus will be displayed, depending where you clicked.

■ Wire Object Context Menu (Line Segment)

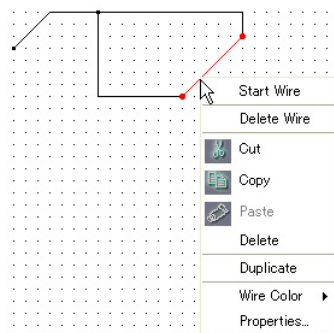

Line Segment Context Menu

[Start Wire]

Begins drawing a line segment from the location where you clicked.

[Delete Wire]

Deletes the entire wire.

[Cut]

Cuts the selected object and moves it to the clipboard.

[Copy]

Copies the selected object to the clipboard.

[Paste]

Pastes the object that is on the clipboard.

[Delete]

Deletes the line segment where you right-clicked.

[Duplicate]

Duplicates the wire object.

[Wire Color]

Specifies the wire color.

[Properties]

Displays the “Wire Properties” dialog box.

■ Wire Object Context Menu (Node)

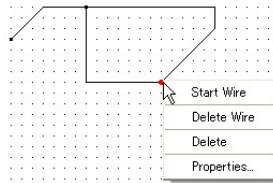

Node Context Menu

[Start Wire]

Begins drawing a wire segment from the location where you right-clicked.

[Delete Wire]

Deletes the entire wire.

[Delete]

Deletes the node. The nodes before and after will become directly connected.

[Properties]

Displays the “Wire Properties” dialog box.

■ Wire Object Context Menu (Termination)

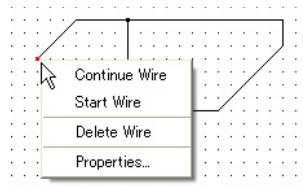

Termination Context Menu

[Continue Wire]

Begins drawing wire from a termination node.

[Start Wire]

Begins drawing a wire from the location where you right-clicked.

[Delete Wire]

Deletes the entire wire.

[Properties]

Displays the “Wire Properties” dialog box.

■ Wire Object Properties

To display the “Wire Properties” dialog box, double-click on a wire object. You can also select a wire object, then click the [Properties] command on the [Edit] menu.

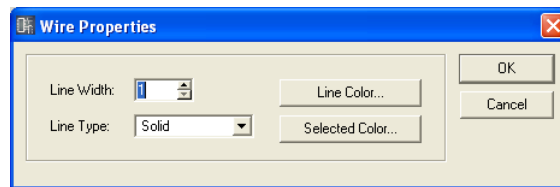

[Line Width] Box

Set the line width. This setting can range from 1 to 10 pixels.

[Line Type]

Displays a list where you can select the type of line. The following types are available: [Solid], [Dash], [Dot], [DashDot], and [DashDotDot].

[Line Color] Button

Sets the color of the line. Clicking here displays the “Select Color” dialog box.

[Selected Color] Button

Sets the color of the selected line. Clicking here displays the “Select Color” dialog box.

NOTE

For information about the “Select Color” dialog box, see [page 265](#).

[OK] Button

Accepts the changed settings and closes the dialog box.

[Cancel] Button

Closes the dialog box without changing the settings.

Legend (Descriptive Fields)

Displays a legend for all sheets except the User Module window.

When you click the [Edit Legend] command on the [Edit] menu or double-click on one of the Legend fields displayed on the sheet, the “Edit Legend” dialog box is displayed. If you right-click on the Legend, the displayed context menu will have the [Edit Legend] command only. If you click there it will display the “Edit Legend” dialog box.

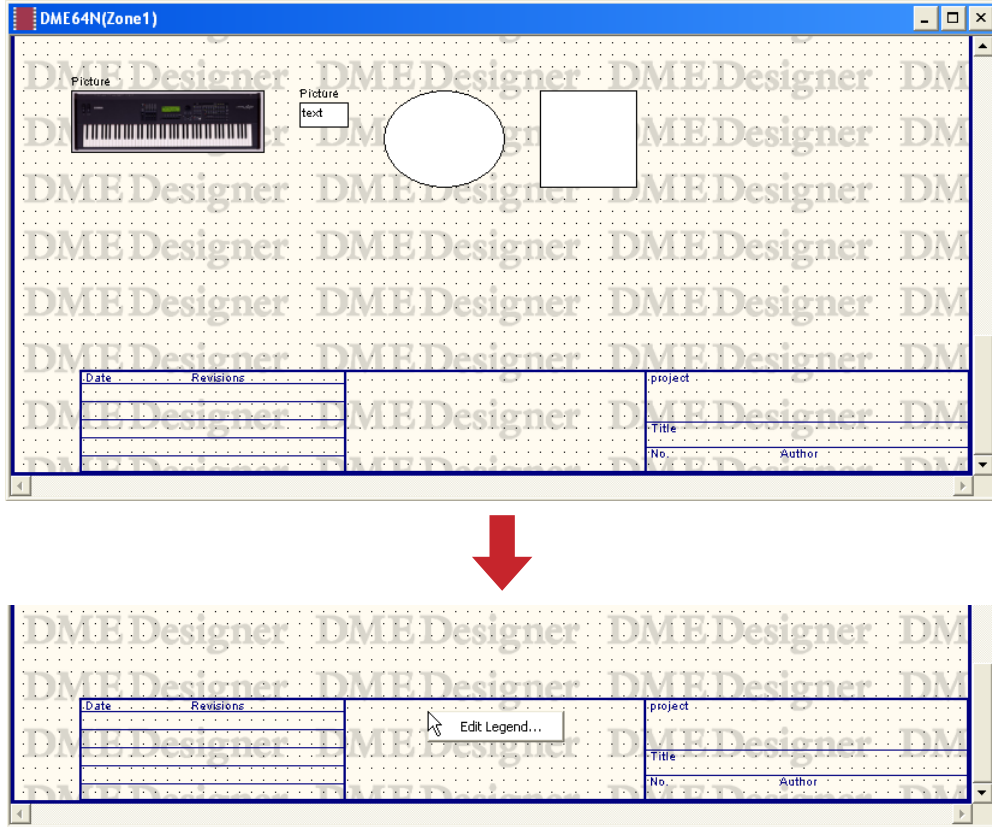

The “Edit Legend” dialog box is used to enable/disable Legend display and to set the contents displayed there. You can display the [Edit Legend] command from the [Edit] menu.

■ “Edit Legend” Dialog Box

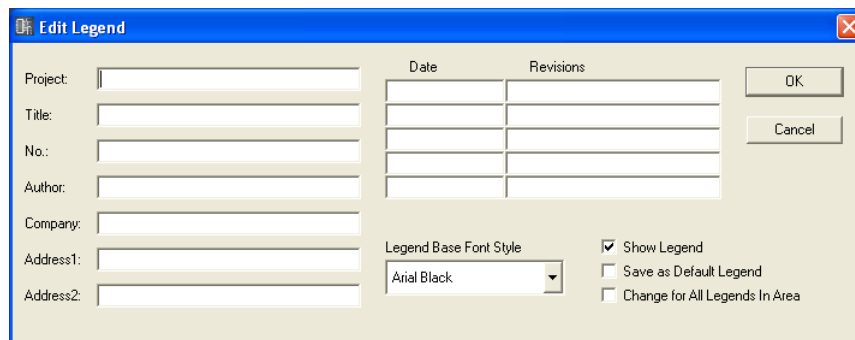

[Project] Box, [Title] Box, [No.] Box, [Author] Box, [Company] Box, [Address1] Box, and [Address2] Box

Used to enter the Project, Title, Number, Author, Company, Address1, and Address2. You can enter up to 100 English characters for each field.

[Date] Box and [Revisions] Box

You can enter up to five dates and five revisions. You can enter up to 100 English characters for each field.

[Legend Base Font Style]

Displays a list where you can select the font.

[Show Legend]

Place a checkmark here to display the legend on the sheet.

[Save as Default Legend]

Saves this legend as the default legend used when a new sheet is created. When a new configuration is created, it will have a legend with the same contents as this one.

[Change for All Legends In Area]

Place a checkmark here to have the changes made here reflected in sheets in all design windows included in the area.

[OK] Button

Accepts the changed settings and closes the dialog box.

[Cancel] Button

Closes the dialog box without changing the settings.

Sheet

There is one sheet in each design window for arranging objects. The size of the sheet and its background image are specified with the “Sheet Settings” dialog box. This dialog box is displayed using the [Sheet] command from the [Tools] menu.

Make the window where you are going to change sheet settings active, then click [Tools] menu → [Sheet].

■ “Sheet Settings” Dialog Box

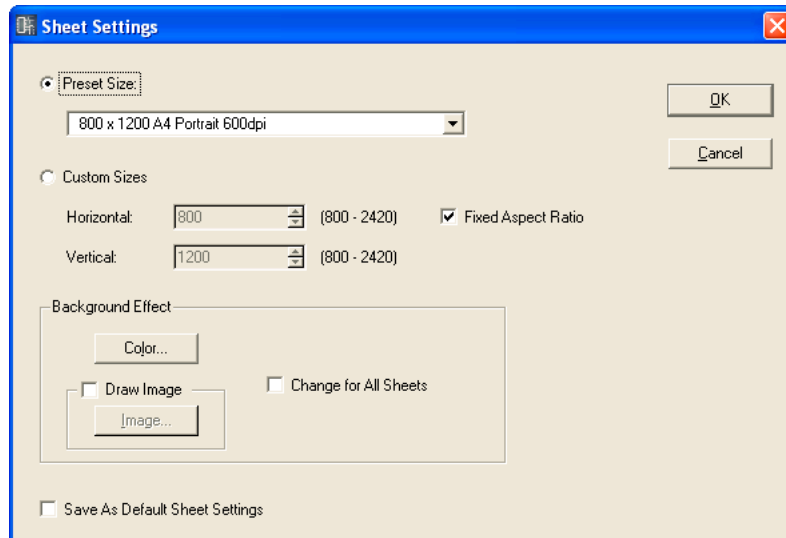

[Preset Size]

Displays a list where you can select preset paper sizes.

When you select a paper size, numerical values are set for [Horizontal] and [Vertical].

[Custom Sizes]

Set a custom size by specifying the vertical and horizontal sizes of the sheet.

- **[Horizontal] Box**
Sets the horizontal width of the sheet.
- **[Vertical] Box**
Sets the vertical height of the sheet.
- **[Fixed Aspect Ratio]**
When this is checked the relationship between horizontal and vertical is fixed. When the value for [Horizontal] or [Vertical] changed, the size of the other direction changes so that the proportions of the paper remain the same.

NOTE

The upper left is the starting point for measuring sheet size. Therefore, in the [Horizontal] box set the number of pixels to the right edge, and in the [Vertical] box, set the number of pixels to the lower edge. The boundaries in which items are already arranged on the sheet will form the minimum sheet size.

Because any objects that are moved, cut, or deleted will return to the same location if the [Undo] command is used, the minimum sheet size will be determined by the boundaries in which any objects were located, now or in the past.

Background Effect

Sets the background for the sheet.

- **[Color] Button**

Sets the color of the background. Clicking here displays the “Select Color” dialog box. For information about the “Select Color” dialog box, see [page 265](#).

- **[Draw Image] Button**

When this check box is checked, an image file is displayed as the sheet background. You can use image files in the following formats: BMP (.bmp), PNG (.png), XPM (.xpm), and JPEG (.jpg). Clicking the [Image] button displays the “Select Image” dialog box. For information about the “Select Image” dialog box, see [page 267](#).

- **[Change for All Sheets]**

Changes all sheets so that they are the same.

[Save As Default Sheet Size]

When turned ON, the current values will become the default for creating sheets. New sheets will be created at the same size.

[OK] Button

Accepts the changed settings and closes the dialog box.

[Cancel] Button

Closes the dialog box without changing the settings.

“Select Font” Dialog Box

When you click the [Font] or [Label Font] button in an object’s properties dialog box, the “Select Font” dialog box is displayed. Sets the font.

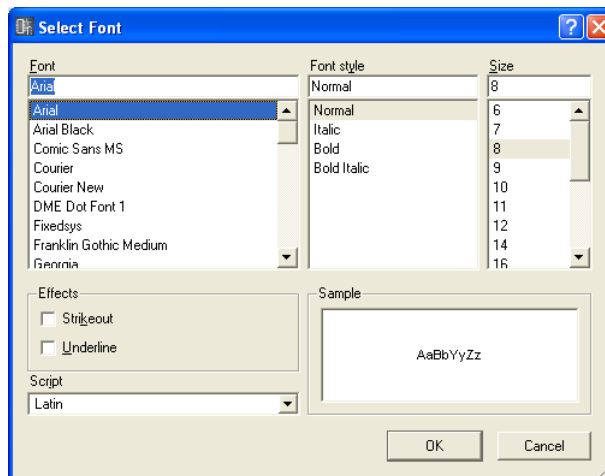

■ Font

Selects the font. The currently selected font name is displayed in this box. Select a font by clicking its name on the list.

■ Font Style

Sets the style of the text. The currently selected style is displayed in the box. Select a style by clicking its name on the list below.

- Normal Standard style
- Italic Italic or slanted text
- Bold Bold text
- Bold Italic..... Bold italic text

■ Size

Sets the text size. The currently selected size is displayed in the box. Select a size by clicking it in the list below.

■ Effects

Sets effects for the text. Check the effects you wish to set.

- Strikeout..... Adds a strikeout line through the center of the text.
- Underline Adds an underline to the text.

■ Script

From the list, select the script (language) for the text. There is no need to change the language setting unless you want to specify a specific language.

■ Sample

Displays an example of the current settings.

“Select Color” Dialog Box

When you click the [Color] or [Label Color] button in an object's properties dialog box, the “Select color” dialog box is displayed. Sets the color of objects and text.

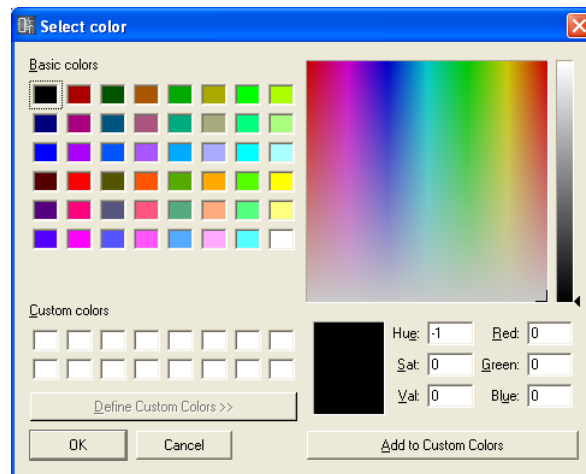

■ Setting Basic Colors

There are 48 basic colors provided in the [Basic colors] section. When you select a basic color by clicking on it, the position of that color in the color palette to the right is indicated by a cross (+). Information about the selected color is displayed below the color palette. Click the [OK] button to set the color you selected.

■ Setting Colors That Are Not in the [Basic colors] Section.

You can select any color in the color palette displayed at the upper-right of the dialog box by clicking on it in the palette. Color information is displayed below the color palette. If you like the color you selected, click the [OK] button. If you don't like the color, you can select a new color by clicking in another location in the color palette, or by dragging the cross symbol to another location there.

Grey colors can be selected on the tall, thin chart to the right of the palette. Click the [OK] button to set the color you selected.

■ Saving Colors You Have Created

In the custom color section, you can save up to 16 colors you have created. When you save a custom color, it can be selected by clicking on its color button, in the same way as for the [Basic colors].

Even if you open the “Select color” dialog box from the Properties of another object, any custom color you save will be displayed and you can use that same color for the other object.

- 1 Click the [Custom colors] box where you will save the color you create.
The box you clicked will be selected and a frame will appear around it.

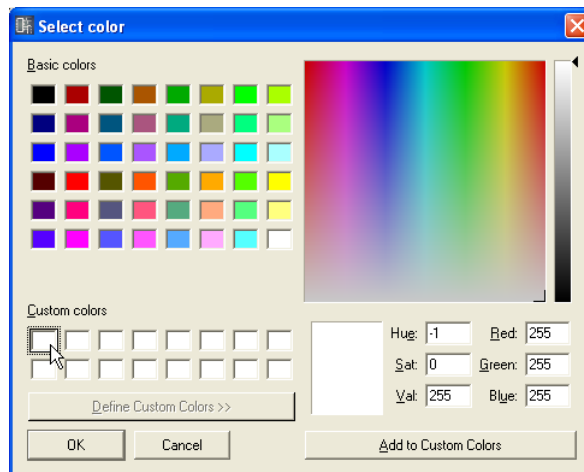

- 2 Set the color on the color palette.
- 3 Click the [Add to Custom Colors] button.
The selected color will be added to [Custom colors].

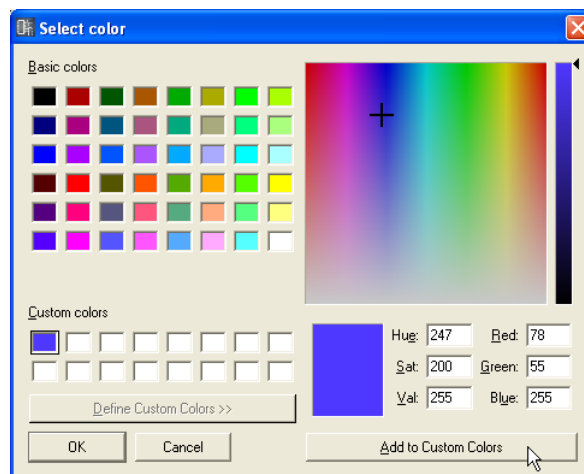

NOTE

You can save another color in a box that already has an original color saved in it. Just click on the box to select it. The new color will overwrite the previous color, which will be lost.

“Select Image” Dialog Box

You can display an image for the background of sheets or objects. You can use image files in the following formats: BMP (.bmp), PNG (.png), XPM (.xpm), and JPEG (.jpg).

In the project file, the location and name of the image file are registered in a relative path below the [ContentsFolder] and the linked image file is read and displayed. If the image file is moved, renamed, or the [ContentsFolder] is changed, the image cannot be displayed.

If you click the [Image] button in the properties dialog box for an object that can display a background image or in the “Sheet” dialog box, the “Select Image” dialog box will be displayed. Specify an image file and set its display method.

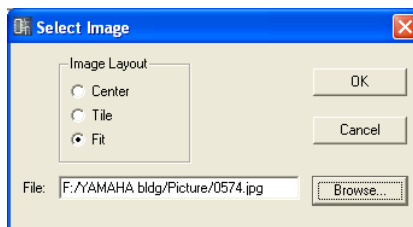

Image Layout

Selects the manner in which the image file will be displayed.

- **[Center]**
Centers the image in the object or sheet.
- **[Tile]**
Displays multiple copies of the image side-by-side until the available space is filled. If the image file is smaller than the sheet, it will be displayed repeatedly like tiles on a wall.
- **[Fit]**
Expands or reduces the size of the image to match the size of the sheet where it will be displayed.

[File] Box

Specifies a path for the image file. A path can be directly entered in the box. You can also click the [Browse] button and select the image file. It will be entered automatically.

To stop display of an image, delete all characters in the box, leaving the field blank.

[Browse] Button

Specifies a path for the image file. Clicking here displays the “Open” dialog box. Select a file with one of the following extensions: “.bmp,” “.png,” “.xpm,” or “.jpg,” then click the [Open] button.

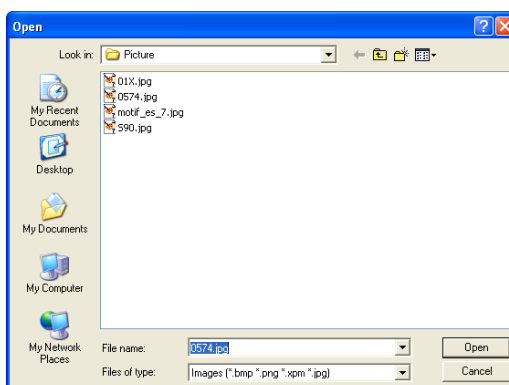

[OK] Button

Accepts the changed settings and closes the dialog box.

[Cancel] Button

Closes the dialog box without changing the settings.

Design Window Shared Settings and Operations

Preferences

You can set the operating environment for the Designer window in the “Preferences” dialog box. This dialog box is opened using the [Preferences] command in the Designer window [Tools] menu.

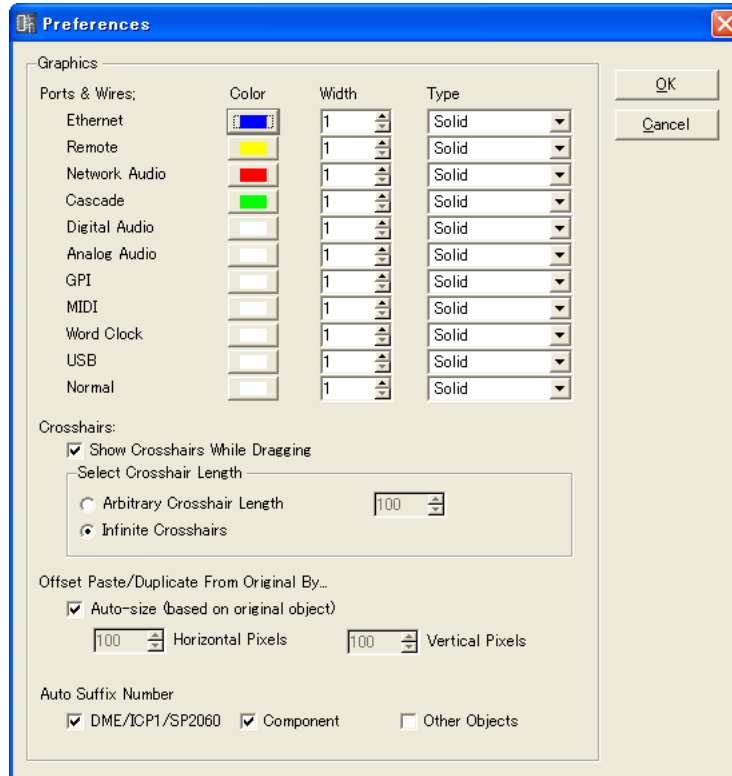

■ Graphics

Ports & Wires

Specifies wire color, thickness, and type for each port type.

- [Color]
Sets the default color for the port and wire.
- [Width]
Sets the default wire width from a range of 1 to 5.
- [Type]
Sets the port type.

NOTE

The initial color and thickness of the wires produced when drawing connections are specified here. The color and thickness of drawn wires can be changed via the Wire Properties dialog box.

Crosshairs

- **[Show Crosshairs While Dragging]**
Place a checkmark here to have crosshairs displayed for guidance when dragging the wire endpoint.
- **[Select Crosshair Length]**
Specifies the length of the crosshair lines.
Enter a number into the [Arbitrary Crosshair Length] box to specify the length in pixels.
[Infinite Crosshairs] causes the lines to go all the way to the edge of the window.

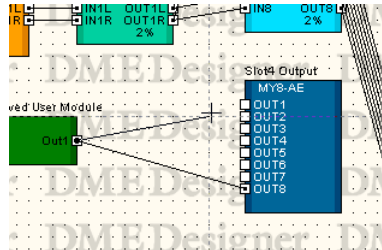

Offset Paste/Duplicate from Original By

Sets the position when pasting or duplicating objects.

- **[Auto-size (based on original object)]**
If you place a checkmark here, the paste/duplicate position will be automatically adjusted so that the object does not overlap the original object.
- **[Horizontal Pixels] Box**
Sets the horizontal distance.
- **[Vertical Pixels] Box**
Sets the vertical distance.

Auto Suffix Number

Turns automatic appending of sequentially-numbered suffixes to the names of placed objects on or off.

- **[DME/Speaker Processor]**
When ON numbered suffixes will automatically be appended to added DME, SP2060 and ICP objects.
- **[Component]**
When ON numbered suffixes will automatically be appended to added SPX and user module objects.
- **[Other Objects]**
When ON numbered suffixes will automatically be appended to added objects not covered by the above two categories.

[OK] Button

Accepts the changed settings and closes the dialog box.

[Cancel] Button

Closes the dialog box without changing the settings.

Grid

Displays a grid on the sheet in each design window to guide the placement of objects. You can also have the objects “snap to” (automatically align with) the grid when dragging them. When you click the [Grid] command on the [Tools] menu, the “Grid” dialog box is displayed. Here you can enable or disable display of the grid and set the grid interval and form.

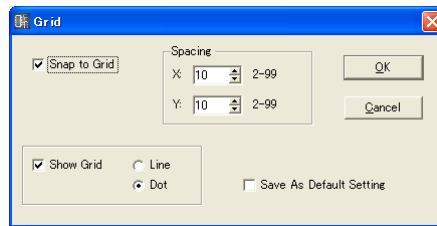

[Snap to Grid]

Makes objects align the grid when dragging them.

Spacing

This sets the spacing of the grid. This setting can range from 2 to 99 pixels.

- **[X:] Box**
This sets the spacing of the grid in the horizontal direction.
- **[Y:] Box**
This sets the spacing of the grid in the vertical direction.

[Show Grid]

Displays the grid. Place a checkmark here to enable display and select the type of grid.

- **[Line]**
Displays the grid using lines.
- **[Dot]**
Displays the grid using dots.

[Save As Default Setting]

Place a checkmark here to make the current grid settings the default when a new sheet is created.

[OK] Button

Accepts the changed settings and closes the dialog box.

[Cancel] Button

Closes the dialog box without changing the settings.

Exporting Each Design Window

Instead of saving projects in their entirety, you can output the information contained in the active window using the Designer Window [Print] → [Export DXF] command and save it in a DXF format file. These files have “.dxf” as their filename extension.

Because the DXF format uses the standard CAD file format, it can be opened using CAD software. DXF format files can also be opened by graphics software that support vector graphics, such as Adobe Illustrator®.

NOTE

Configurations are saved in project files. This is done using the [File] menu → [Save] and [Save As] commands in the Main Panel window. For information about saving project files see “Project Files” on page 34.

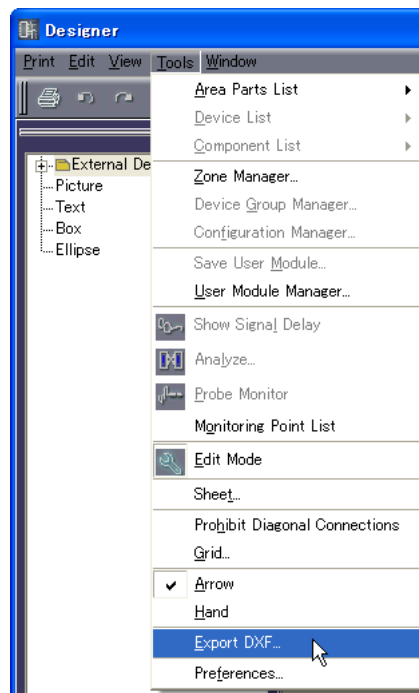

- Symbols are substituted for external devices in the following three types of folders.
 - Microphone → mike symbol
 - Power Amp → amp symbol
 - Speaker → speaker symbol
- Text decoration except for size will be eliminated.
- Picture objects and background images for the sheet or objects will all be eliminated. [Style] attributes for boxes will be eliminated.

When you select this command, the “Export DXF” dialog box will be displayed.

“Export DXF” dialog box

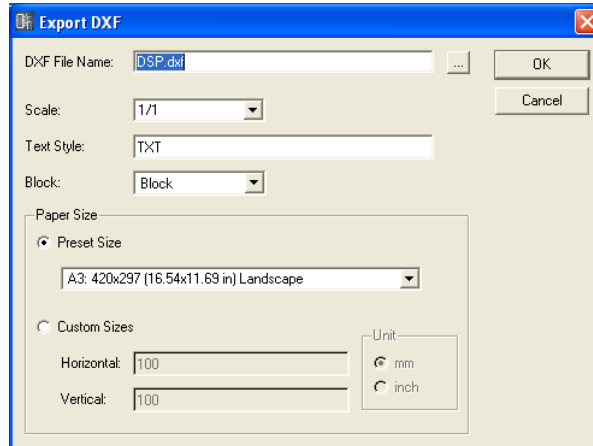

■ DXF File Name

Enter a filename for the DXF file. The default file name entered here will vary according to the currently active window.

If you click the [...] button at the right of the box, the “DXF File Name” dialog box is displayed. Specify the DXF file filename and the folder where the file will be saved.

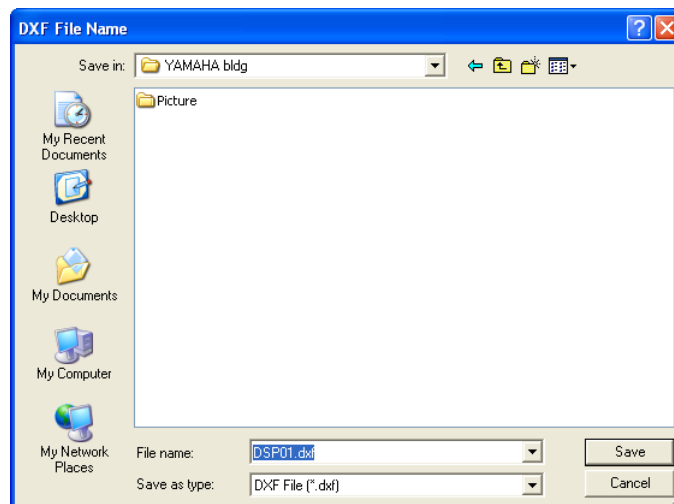

Enter the filename, specify the folder where the file will be saved, then click the [Save] button. When you return to the “Export DXF” dialog box, the specified filename will be displayed in the [DXF File Name] box.

NOTE

When you click on the [Save] button in the “DXF File Name” dialog box, the DXF file is not saved. Only when you click on the [OK] button in the “Export DXF” dialog box, does the DXF file become saved.

■ Scale

Sets the reduction ratio. When the size of the sheet is large, you can reduce it before exporting it.

■ Text Style

Specifies the text font for output in DXF format. The default is the “TXT” (drawing font used in CAD).

■ Block

Sets the block form used in the sheet. Displays a list where you can select the form.

[Block]

Makes the blocks rectangular and groups the text in the port icons and port names.

[Explode]

Makes the blocks into sets of four lines, and does not group the text in the port icons and port names.

■ [Paper Size]

Sets the size of the paper.

[Preset Size]

Displays a list where you can select preset paper sizes. When you select a paper size, numerical values are set for [Horizontal] and [Vertical].

[Custom Sizes]

Set a custom size by specifying the vertical and horizontal sizes of the sheet.

- **[Horizontal] Box**
Sets the horizontal width of the sheet.
- **[Vertical] Box**
Sets the vertical height of the sheet.

[Unit]

Selects the unit used for setting the sheet size.

[OK] Button

Saves the DXF file according to the settings in the dialog box.

[Cancel] Button

Cancels the DXF file export process.

Printing Each Design Window

You can print out the content of each design window just as it appears on the screen. The content in the window will be expanded or reduced in size as necessary to match the size and orientation of the paper, and printed onto a single sheet of paper. Commands related to printing are found on the Designer Window [Print] menu.

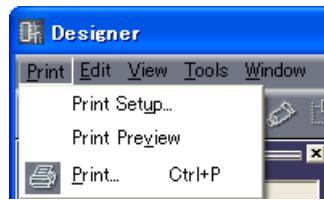

■ [Print Setup]

When you select this command, the "Print Setup" dialog box will be displayed. Sets the paper size and orientation.

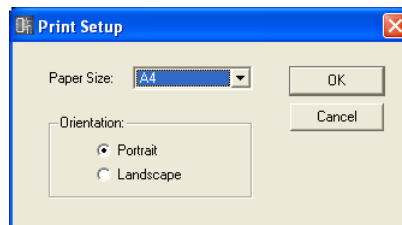

[Paper Size]

Displays a list where you can select the paper size.

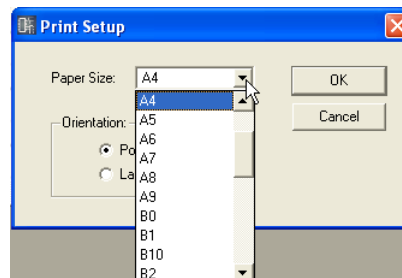

Orientation

Sets the orientation of the paper.

- [Portrait]
Prints on the paper with its long sides vertical.
- [Landscape]
Prints on the paper with its long sides horizontal.

[OK] Button

Accepts the changed settings and closes the dialog box.

[Cancel] Button

Closes the dialog box without changing the settings.

■ [“Print Preview” window]

Displays a print preview of the active design window. You can check the appearance of the page before printing it.

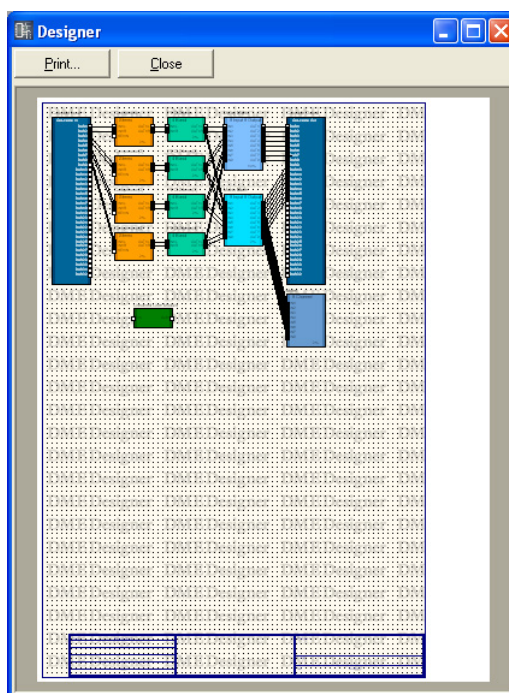

[Print]

Displays the “Print” dialog box.

[Close]

Closes the print preview window.

Arranging Objects

Multiple object placement methods are available.

■ Dragging from the Toolkit Window

You can drag items from the Toolkit window to the location where you want to place them in each design window.

■ Double-Clicking an Object in the Toolkit Window

You can double-click an object in the Toolkit window to place it in each design window.

■ Selecting from the [Tools] Menu

Available objects are displayed on the [Area Parts List]/[Device List]/[Component List] submenus which are accessed from the [Tools] menu. When you click an object name, the mouse pointer changes shape. Click the location on the sheet where you want to place the object.

■ Selecting from the Context Menu

If you right-click on the sheet, you will see the [Area Parts List]/[Device List]/[Component List] commands displayed on the context menu that appears. When you click an object name on the submenu, the mouse pointer changes shape. Click the location on the sheet where you want to place the object.

Device Group Selection

When laying out DME, SP2060, and ICP1 objects the “Device Group and Sampling Frequency” will be showing.

■ “Device Group and Sampling Frequency Settings” Window

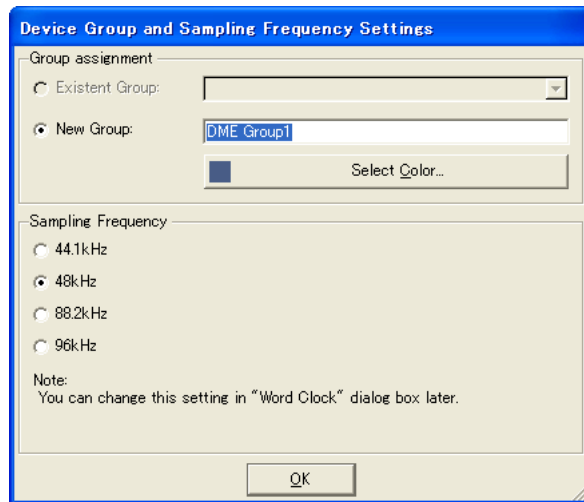

Group Assignment

Selects a device group.

- **Existent Group**

Allows an existing group to be selected from a list. If a group does not exist it will be grayed out in the list and cannot be selected.

- **New Group**

Creates a new group. The initial color of the new group's name and added devices can be edited as required.

Sampling Frequency

Specifies the sampling frequency.

NOTE

The sampling frequency can be changed from that specified in the “Word Clock” window. Refer to “Word Clock” on [page 139](#) for information on the “Word Clock” window.

NOTE

A sampling frequency cannot be set for ICP1 units.

Selecting Objects

Objects can be selected when the mouse cursor appears as crosshairs.

■ Selecting with a Click

You can select an object by clicking on it. If you click another object or an empty location on the sheet, it will cancel selection of the object you previously clicked.

■ Selecting with Click + <Ctrl> Key

When you want to select multiple objects, hold down the <Ctrl> key as you click each new object you want to select. If you hold down the <Ctrl> key and click again on one of the objects that is part of the multiple selection, it will cancel selection of that single object.

■ Selecting by Dragging

If you position the mouse in an empty location on the sheet and start dragging from there, a frame will be displayed as the pointer moves. Any objects within this frame will be selected.

■ Changing the Selected Object Using the <Tab> Key

When a single object is selected, you can change the selection to the next object by pressing the <Tab> key. If you press <Shift> + <Tab>, the selection moves to the previous object. The selection order moves from left to right.

NOTE

Wires cannot be selected with the <Tab> key.

Editing Objects

Objects that have been arranged on the sheet can be edited using the [Cut], [Copy], [Paste], [Duplicate], and similar commands in the [Edit] menu. These edit commands will also appear in the context menu displayed when you right-click an object in the design window. Buttons for [Cut], [Copy], and [Paste] are also available on the Designer window toolbar.

NOTE

Some objects cannot be edited.

■ Undoing and Redoing Operations

You can undo operations using the [Undo] command on the [Edit] menu. You can use the [Redo] command to redo operations that have been undone.

■ Deleting Objects

Objects can be deleted by selecting them and pressing the <Delete> key.

NOTE

Some objects cannot be deleted. With some other objects, you must first make appropriate settings in a dialog box before you can delete them.

■ Moving Objects

You can move objects by dragging them with the mouse. If [Snap to Grid] is ON in the "Grid" dialog box, the dragged objects will automatically align with the grid.

You can also move a selected object using the arrow keys. If [Snap to Grid] is ON in the "Grid" dialog box, the selected object will move from grid line to grid line. If [Snap to Grid] is OFF, the object will move pixel to pixel.

Changing the Order

Objects newly placed on the sheet will be displayed above any previously placed objects they overlap. You can change this behavior using the [Display Order] command on the [Edit] menu. Select the object for which you want to change the display order, then select the appropriate command from the [Display Order] submenu on the [Edit] menu.

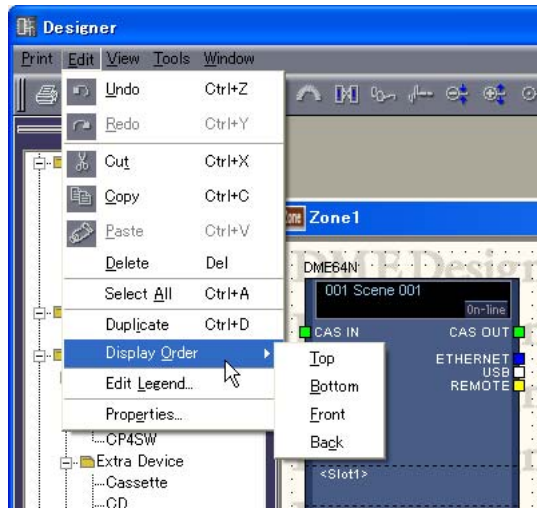

[Top]

Moves the selected object to the top of the stack.

[Bottom]

Moves the selected object to the bottom of the stack.

[Front]

Moves the selected object up one level in the stack.

[Back]

Moves the selected object down one level in the stack.

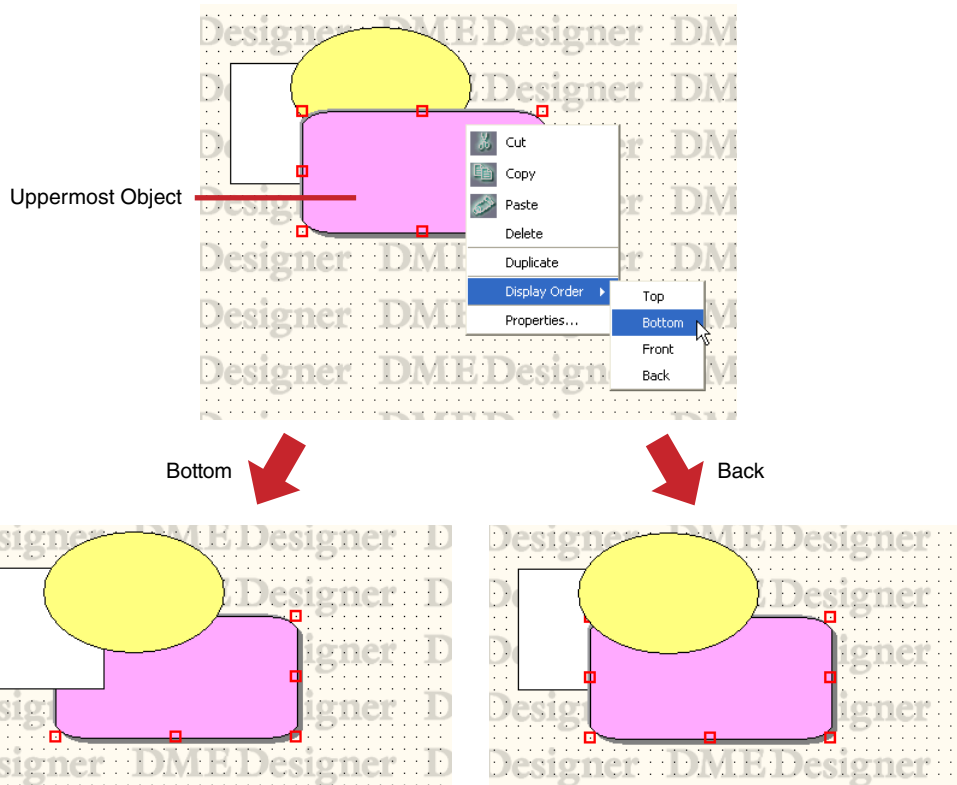

Drawing and Editing Wires

Wire

Objects that are arranged on sheets in the Configuration or User Module windows can be connected to each other by wires. Not only does this let you logically connect signal sources (output side) and destinations (input side), it also lets you draw connections and independent lines on the display. Each wire has at least two wire nodes. Between the nodes are line segments.

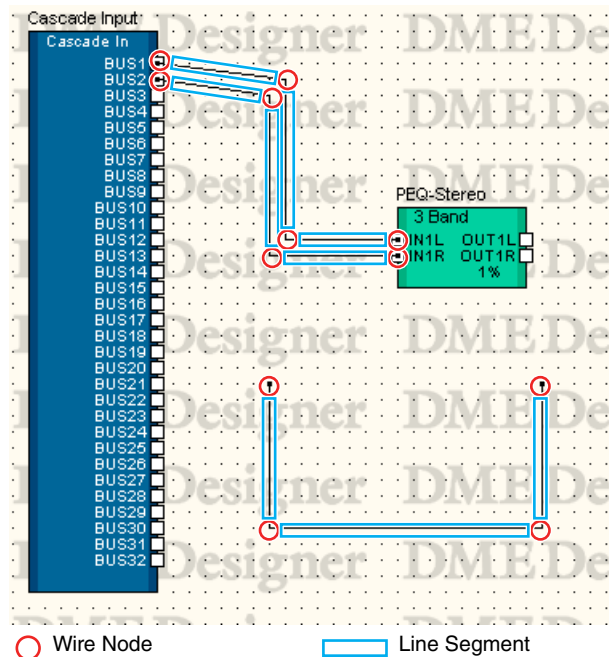

■ Selecting Wires and Canceling Selection

You can select a line segment by clicking on it.

If you hold down the <Alt> key while clicking, you will select the entire wire.

NOTE

The color used when a wire object is selected can be set with [Selected Color] in the “Wire Properties” dialog box.

■ Line Segment

The line width default value is set from one to five pixels in the Designer window “Preferences” dialog box. In the “Wire Properties” dialog box, the line thickness and color can be adjusted as required for the various wires arranged on the sheet.

Line Segment Selection

When you select a line segment by clicking on it, only that line segment is selected. If you hold down the <Ctrl> key while clicking, you can select multiple line segments. Furthermore, if you drag the mouse from an empty location on the sheet so that nodes are enclosed by a box, line segments between those nodes will be selected.

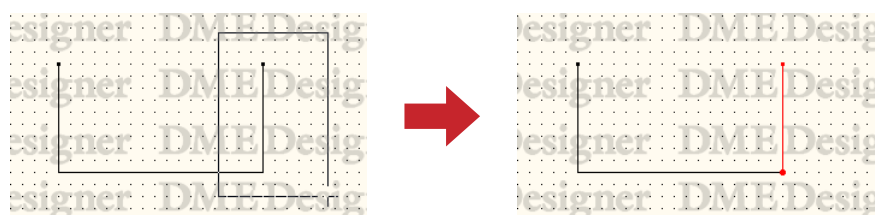

Canceling Line Segment Selection

If you select another object or an empty location on the sheet, it will cancel selection of the object you previously clicked.

You can also cancel selections by holding the <Ctrl> key while clicking.

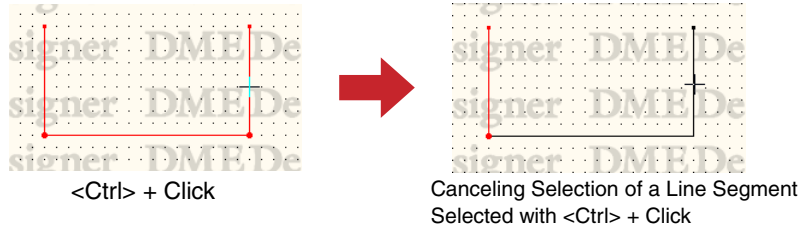

■ Wire Nodes

Both ends of a wire, the location where wires bend, and the location where wires diverge are called “**Nodes**.” When a wire object is not selected, its nodes are not displayed. When a wire is selected, the nodes are displayed with a red circle.

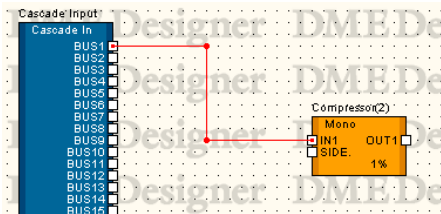

Node Selection

When you click on a node, only that node itself is selected. You can select multiple nodes by holding down the <Ctrl> key while clicking. Furthermore, if you drag the mouse from an empty location on the sheet so that nodes are enclosed by a box, the enclosed nodes will be selected.

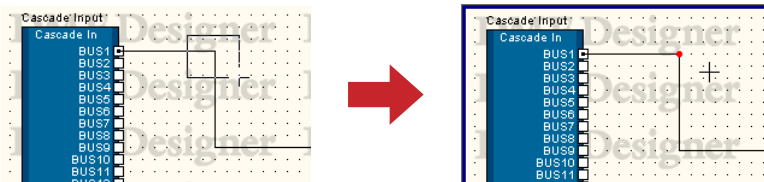

Canceling Node Selection

If you select another object or an empty location on the sheet, it will cancel selection of the object you previously clicked.

You can also cancel node selections by holding the <Ctrl> key while clicking. With this technique, you can cancel only the node you clicked on when multiple nodes are selected.

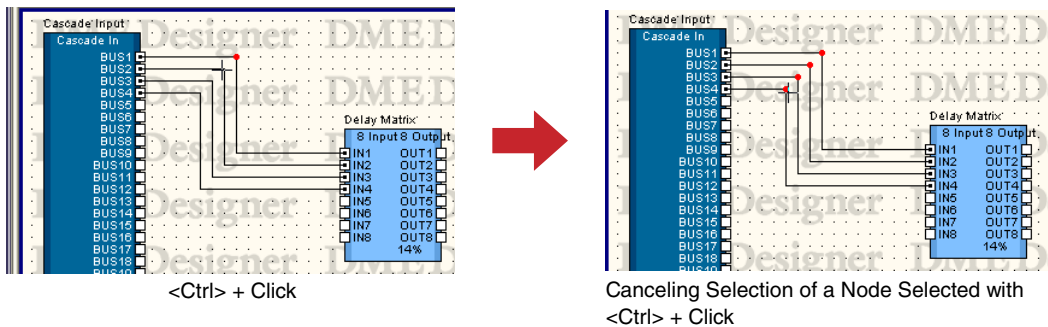

Hotspot

The small white rectangles at the edge of objects are called “**Hotspots**.” Wires usually connect to hotspots.

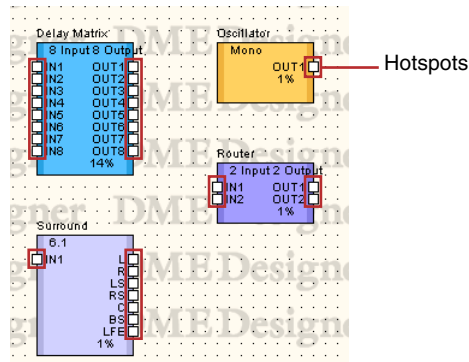

- Some hotspots do not have a connection to a logical signal within the hardware.
- Component and user module hotspots normally include logical connections.
- External device hotspots do not include logical connections.

■ Selecting Hotspots

If you click a hotspot, drawing will start. To select, press <Shift> + click.

You can select multiple hotspots as follows: Select a hotspot with <Shift> + click, then select additional hotspots using <Ctrl> + <Shift> + click.

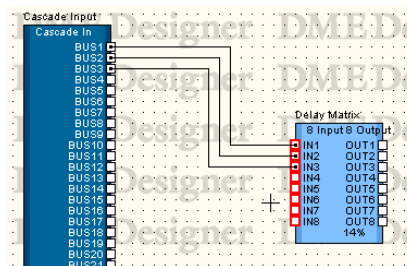

Using Shortcuts

Press the [F2] key to select the uppermost open hot spot to the right of the selected object and begin drawing a wire.

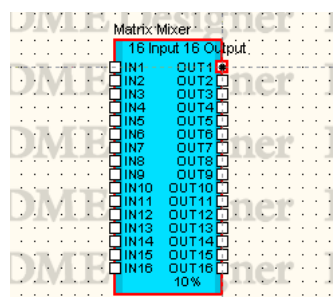

Press <Shift> + [F2] to select the uppermost open hot spot to the left of the selected object and begin drawing a wire.

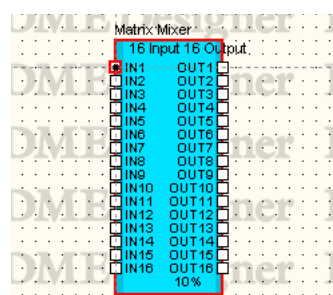

Drawing Settings

Several functions are available to help ensure accurate wire drawing.

■ Grid

To accurately draw in relation to the grid, turn ON [Snap to Grid] in the “Grid” dialog box.

■ Draw Exact Vertical and Horizontal Lines

When [Prohibit Diagonal Connections] in the [Tools] menu is turned ON, wires will be drawn using horizontal and vertical lines only. Diagonal wires cannot be drawn. To activate this function, select it from the menu so that a checkmark appears next to the command name in the menu. Selected the command again to remove the checkmark and deactivate the function.

You can also limit wire drawing to horizontal and vertical lines by holding the <Shift> key while drawing the wires.

NOTE

You can change the positions of existing components or nodes while converting the existing wires to wires composed only of horizontal and vertical lines by activating the [Prohibit Diagonal Connections] function. You can draw diagonal lines holding the <Shift> key while dropping the objects.

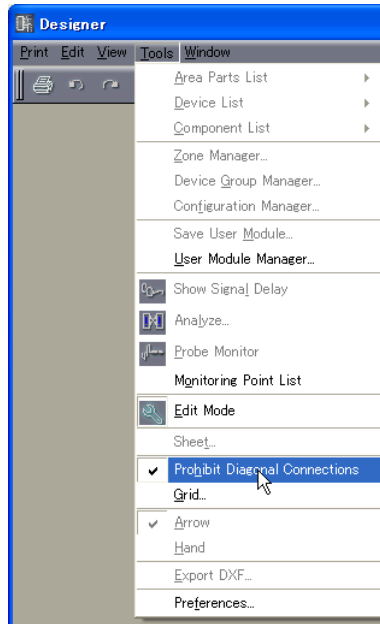

Wire Drawing

Wire drawing starts at the positions shown in the following table:

Drawing Start Location	Start Method
Hotspot	Click
Wire End Terminal	Right-click → click [Continue Wire] on the menu
Node	Right-click → click [Start Wire] on the menu
Line Segment	Right-click → click [Start Wire] on the menu
Anywhere on the Sheet	Right-click → click [Start Wire] on the menu

NOTE

When creating diagrams the keyboard cursor keys can be used to move the mouse cursor, and the <Enter> Key can be used to create nodes.

■ Connecting Hotspots with Hotspots

Method 1 Clicking

Click the hotspot where the connection originates to begin drawing, then click the destination hotspot. The two hotspots will be connected by a wire.

NOTE

A termination cannot be connected to a terminal that will be shorted. Multiple connections cannot be made to a DME object's Cascade port.

NOTE

When creating diagrams horizontally aligned hot spots can be automatically connected by pressing the <Shift> + <→> keys or <Shift> + <←> keys.

Method 2 Dragging

Drag from the origin hotspot to the destination hotspot.

NOTE

A termination cannot be connected to a terminal that will be shorted. Multiple connections cannot be made to a DME object's Cascade port.

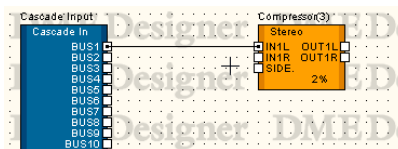

Using Shortcuts

Press the [F4] key to connect the uppermost open hot spot to the right of the selected object and the uppermost open hot spot to the left of the object on the right.

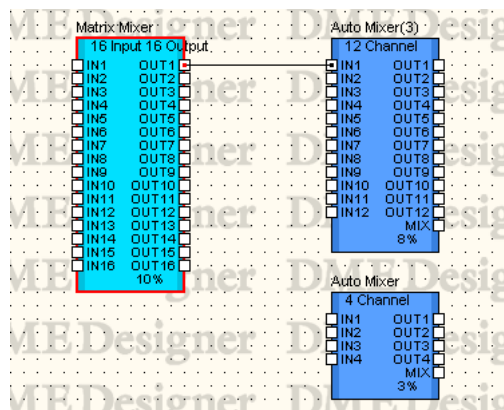

Press <Shift> + [F4] to connect the uppermost open hot spot to the left of the selected object and the uppermost open hot spot to the right of the object on the left.

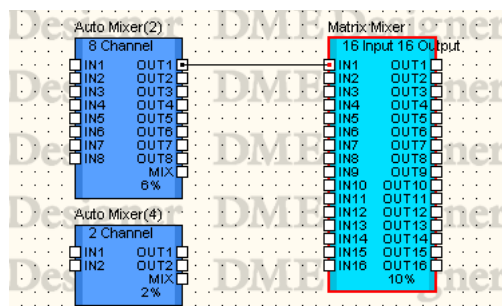

■ Connect with Bent Line

Method 1 From Hotspot to Hotspot

Click the hotspot where the connection originates to begin drawing, then click the location (which will become a node) where you want the line to bend. Finally, click the destination hotspot to complete the connection.

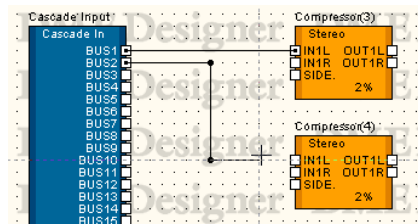

Method 2 From Hotspot to Node or Line Segment

Click the hotspot where the connection originates to begin drawing, then click the location (node) where you want the line to bend. Click an already drawn wire node or line segment to complete the connection. If you connect to a line segment, a node will be created there.

NOTE

A termination cannot be connected to a terminal that will be shorted. Multiple connections cannot be made to a DME object's Cascade port.

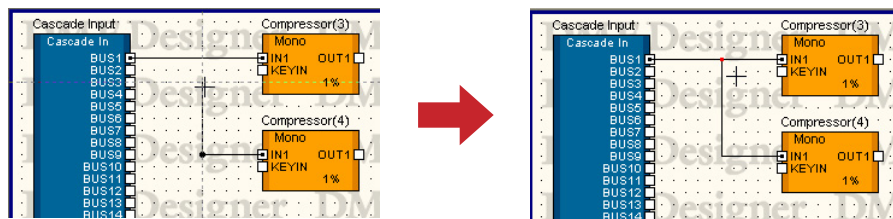

■ Connect Multiple Hotspots in a Single Operation

Method 1 <Ctrl> Key Combinations

If you hold down the <Ctrl> key when finishing dragging, a wire will be drawn at all origin hotspots. The wire will be connected to the destination hotspot you dragged and those that come after.

Begin dragging from the connection origin hotspot, then press the <Ctrl> key after aligning the mouse pointer with the hotspot you will connect too. A wire will be displayed below the destination hotspot. Finish dragging while holding the <Ctrl> key down.

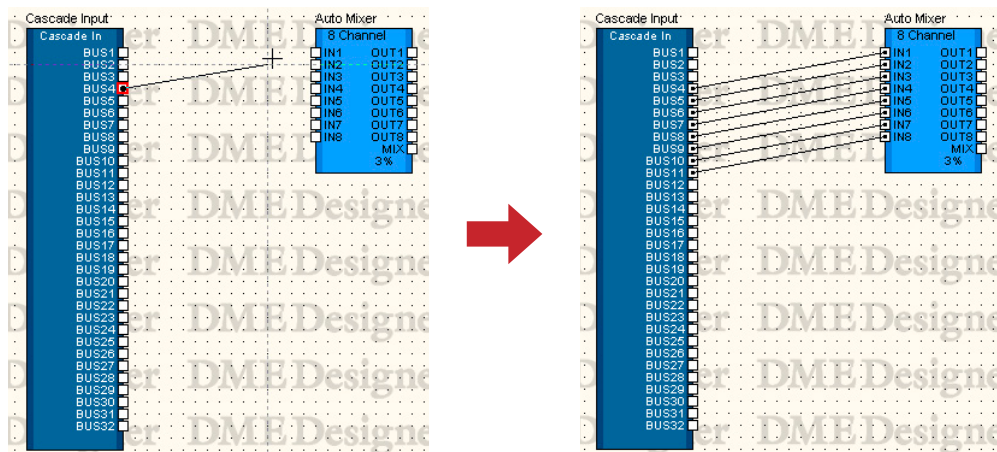

Press <Ctrl> Key

Method 2 Connect Multiple Selected Hotspots

Select multiple hotspots using <Shift> + <Ctrl> + click or <Shift> + drag, then drag from one of the selected hotspots to the destination hotspot. The selected multiple origin hotspots will all be connected.

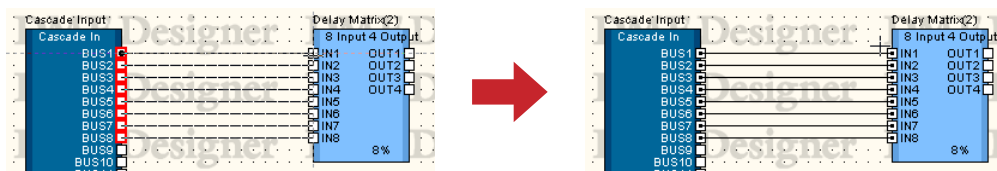

Multiple Hotspots Selected

Press the [F5] key to connect the uppermost open hot spot to the right of the selected object and the uppermost open hot spot to the left of the object on the right, and continue automatically making sequential connections until no more open ports are available on either object. Automatic connections will not be made over other objects.

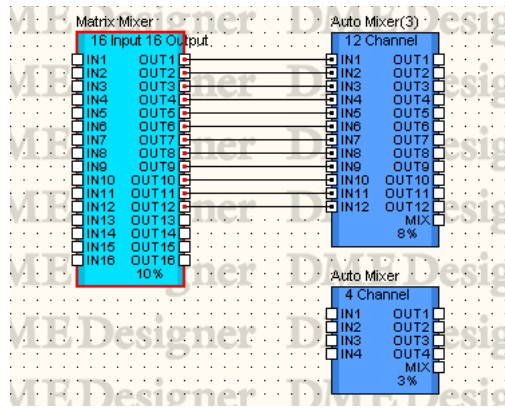

Press <Shift> + [F5] to connect the uppermost open hot spot to the left of the selected object and the uppermost open hot spot to the right of the object on the left, and continue automatically making sequential connections until no more open ports are available on either object. Automatic connections will not be made over other objects.

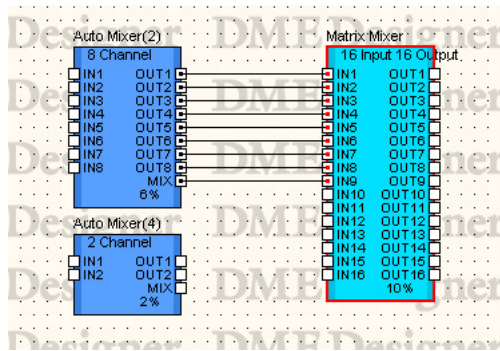

Press the [F8] key to clear all wires connected to the selected object.

NOTE
When multiple objects are selected these operations apply to the first object selected.

NOTE
These shortcuts can be changed as required.
→ See Chapter 3 Main Panel Window, "Shortcut Keys" on [page 156](#).

■ Starting Drawing from the End Point/Node/Line Segment of an Existing Wire

You can draw from the end or midway point of an existing wire. If you start from a node or line segment, a branch line will be created.

Method 1 Continue Drawing from a Wire End Point

When continuing an existing wire, right-click on the wire end point, then click [Continue Wire] on the displayed context menu.

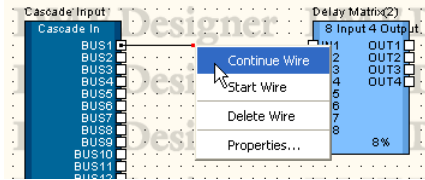

Method 2 Start Drawing from a Node

Right-click on a wire node, then click [Start Wire] on the displayed menu. You can start a branch wire from the node you clicked on.

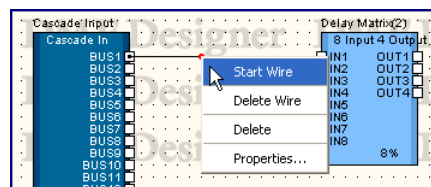

Method 3 Start Drawing from a Line Segment

Right-click on a wire line segment, then click [Start Wire] on the displayed menu. A node will be created at the point you right-clicked, and you can start a branch wire from that node.

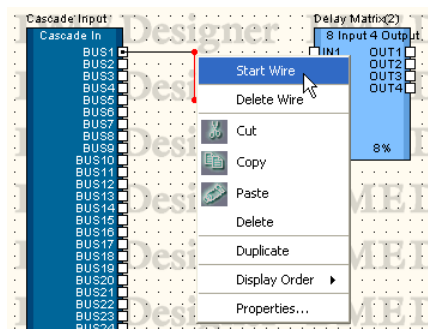

■ Drawing from Anywhere on the Sheet

Right-click the start position for drawing, then click [Start Wire] on the context menu that is displayed. Click the location where the line should bend, then double-click at the end location to finish drawing.

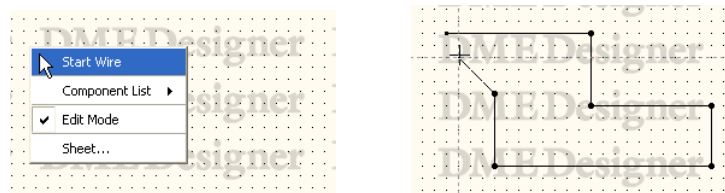

■ Finishing Drawing

When the hotspots or already drawn wires are connected, drawing is finished. To finish drawing without connecting to a hotspot, use one of the following methods:

- Right-click the mouse
- Double-click
- Press the <Esc> key

Drawing also finishes if another window is made active.

Wire Editing

You can delete wires, change node positions, connect to other wires, and perform other wire edit operations.

■ Delete

Deleting an Entire Wire

Right-click the wire then click [Delete Wire] in the context menu

Deleting Nodes

Nodes can be deleted by selecting them and pressing the <Delete> key. Nodes on both sides of the deleted node will become directly connected.

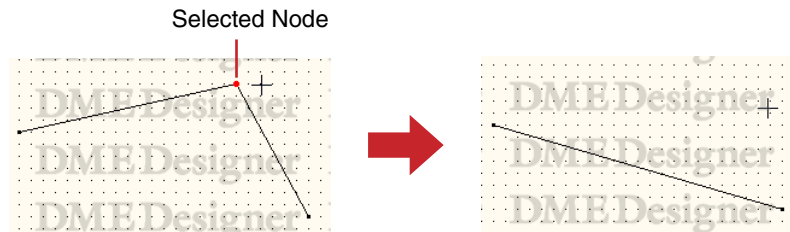

■ Editing by Dragging

Moving Nodes

You can move nodes by dragging them with the mouse.

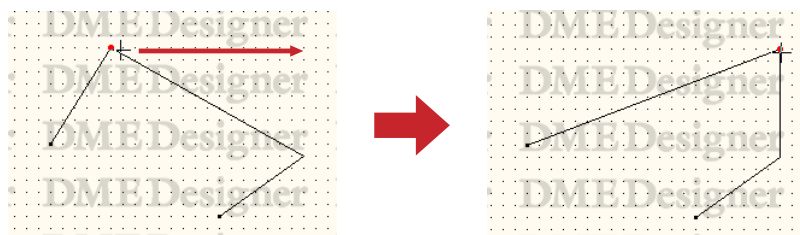

When multiple nodes are selected and dragged with the mouse, you can move all selected nodes simultaneously.

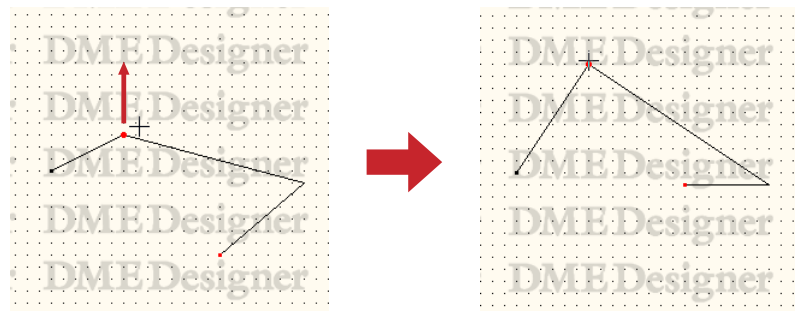

Moving Line Segments

To move a line segment, select the nodes on both sides of the segment, and drag one of the nodes.

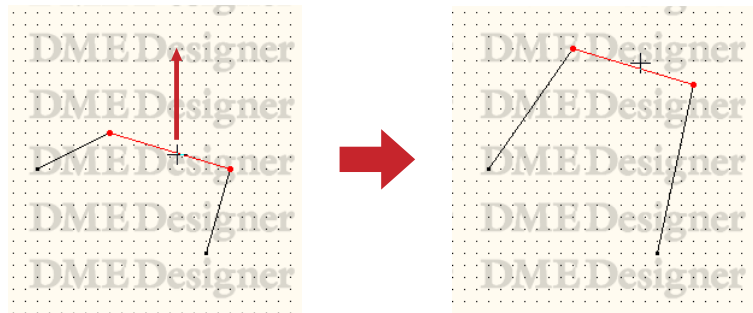

■ Connecting to Other Wires

If you drag a node and lay it over another wire, the two will be connected at that position. If you drag it to a line segment, a node will be created.

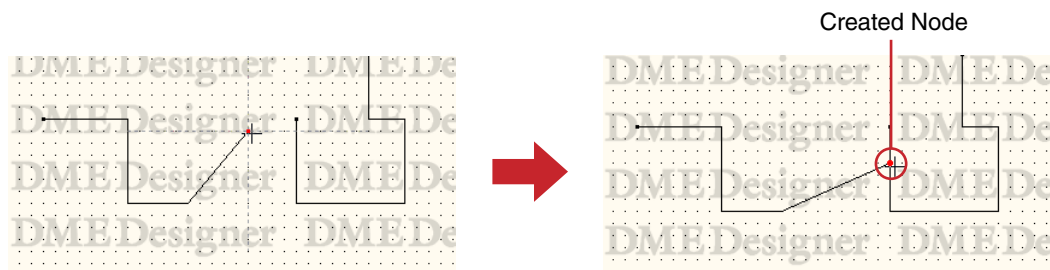

Logical connection

A connection from a source (output side) signal to a destination (input side) signal is called a “**logical connection**.” If a logical connection is present in a configuration, the actual hardware signal will be connected. A single wire can make a single logical connection.

Logical connections are possible only in the Configuration window and the User Module window. Wires in the Area window or Zone window can be drawn for display only. Even in the Configuration window and User Module window, you can also draw wires for display only.

Window	Wire
Area Window	Drawing for display only
Zone Window	Drawing for display only
Configuration Window	Logical connection and drawing for display only
User Module Window	Logical connection and drawing for display only

■ Situations Where No Logical Connection Is Created

- Both sides are source (output side) signals
- Both sides are destination (input side) signals
- Two source (output side) signals are connected to a destination
- There are two destination (input side) signals, and the wire is not connected to a source (output side) signal.

Show Unconnected Node

Turn [Show Unconnected Node] in the [Tools] menu ON to display unconnected nodes as red dots. The [Show Unconnected Node] ON/OFF settings are individually saved with each Configuration Window.

The ON/OFF status of this feature in other Configuration Windows will not affect the current window. If [Show Unconnected Node] is ON, it will automatically be turned OFF if the configuration is edited.

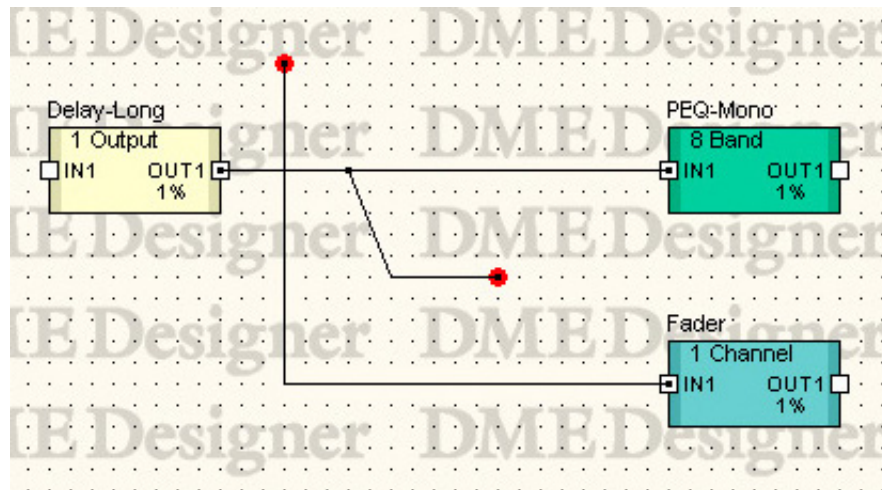

Adding, Deleting, and Renaming a Zone

At least one zone is included within an area. In the default Area window that zone will be named [Zone1]. Multiple zones can be arranged in an Area.

When you click the [Zone Manager] command on the [Tools] menu, the “Zone Manager” dialog box is displayed. Here you can add, delete, or rename a zone.

“Zone Manager” dialog box

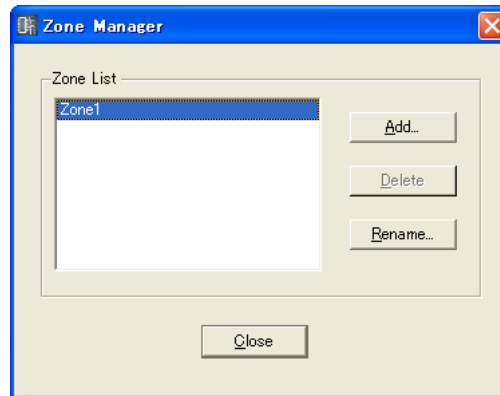

Zone List

Lists the zones included in the project. To change settings for a zone, select it by clicking it in the list.

[Add] Button

Adds a zone. Clicking here displays the “Please enter new name” dialog box. Enter a new name, then click [OK]. A zone will be added.

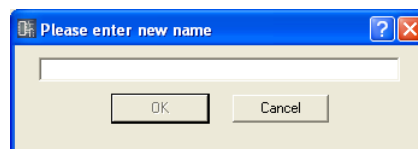

[Delete] Button

Deletes the zone selected on the list. Clicking here displays the “Are you sure?” dialog box. Click the [OK] button, and the zone will be deleted. Click the [Cancel] button, and the deletion will be cancelled.

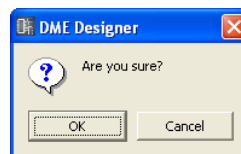

NOTE

A minimum of one zone is required. When only one zone remains, deletion is impossible.

[Rename] Button

Changes the name of the zone selected on the list. Clicking here displays the “Enter new name for the current zone name” dialog box. Enter a zone name, then click the [OK] button.

NOTE

The current name of the zone you will be renaming is displayed in the “Current Zone Name” box of the “Enter new name for current zone name” message.

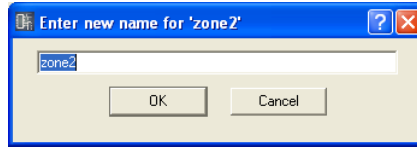

[Close] Button

Closes the “Zone Manager” dialog box.

Changing Device Groups

A zone can include up to 32 device groups, and all devices will belong to one of those groups. Click [Device Group Manager] in the [Tools] menu to open the “Device Group Manager” window, via which device groups can be changed as required.

“Device Group Manager” Window

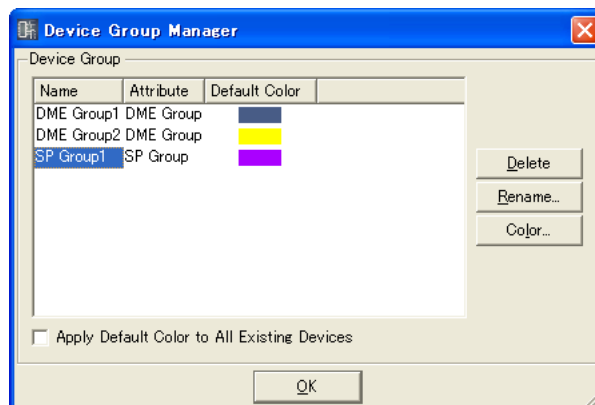

Device Group

All device groups in the zone being edited appear in the list. Click the Slick a device group to select it for editing.

- **Name**
The name of the device group.
- **Attribute**
The type of device group.
- **Default Color**
The default color for devices that are added to the group.

[Delete] Button

Deletes the device group currently selected in the list. An “Are you sure” confirmation box will appear when this button is clicked. The selected device group will be deleted when the [OK] button is clicked. Click the [Cancel] button to abort the delete operation.



NOTE

Device groups cannot be deleted when they include assigned devices.

[Rename] Button

Renames the device group currently selected in the list. The “Enter new name for current device group” window will appear when this button is clicked. Enter a new name for the device group and click the [OK] button.

NOTE

The current name of the selected device group will appear in the name entry window, in place of “current device group” in the window name: “Enter new name for current device group”.

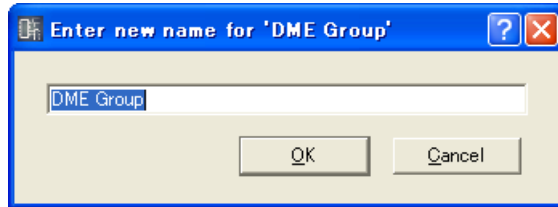
**[Color] Button**

Specifies the default color for new devices added to the currently selected device group. The “Select Color” window will appear when this button is clicked. Refer to “The Select Color Window” on [page 265](#) for information on the “Select Color” window.

Apply Default Color to All Existing Devices

When checked the color of all existing devices will change accordingly when the initial default device color is edited.

[OK] Button

Closes the “Device Group Manager” window.

Adding, Deleting, and Renaming a Configuration

A device group will include at least one configuration, and others can be added as required. When you click the [Configuration Manager] command on the [Tools] menu, the “Configuration Manager” dialog box is displayed. Here you can add, delete, or rename a configuration.

NOTE

Simply adding a new configuration does not make the new configuration active. To switch to the new configuration it must be clicked in the Navigator window ([page 197](#)).

“Configuration Manager” dialog box

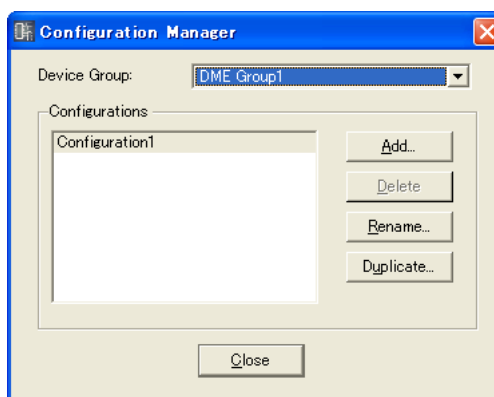

Device Group

Select the device group to be edited from the list.

Configurations

Lists the configurations included in the device group being edited. To change settings for a configuration, select it by clicking it in the list.

[Add] Button

Adds a configuration. Clicking here displays the “Please enter new name” dialog box. Enter a configuration name, then click [OK]. A configuration will be added.

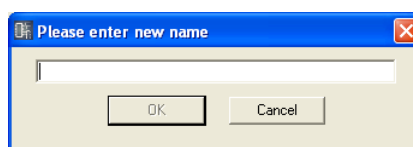

[Delete] Button

Deletes the configuration selected on the list. Clicking here displays the “Are you sure?” dialog box. Click the [OK] button, and the configuration will be deleted. Click the [Cancel] button, and the deletion will be cancelled.

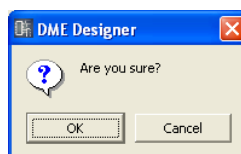

NOTE

A minimum of one configuration is required. When only one configuration remains, deletion is impossible.

[Rename] Button

Changes the name of the configuration selected on the list. Clicking here displays the “Enter new name for the current configuration” dialog box. Enter a configuration name, then click the [OK] button.

NOTE

The current name of the configuration you will be renaming is displayed in the “Current Configuration Name” box of the “Enter new name for current configuration name” message.

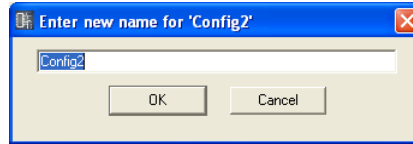
**[Duplicate] Button**

Copies the configuration selected on the list. Clicking here displays the “Please enter new name” dialog box. Enter a configuration name, then click the [OK] button.

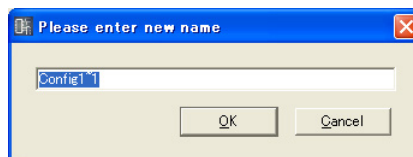
**[Close] Button**

Closes the “Configuration Manager” dialog box.

Area Window

In the Area window, the area is designed by arranging objects on a design sheet. When you click “Area” in the Navigator window, the Area window becomes active. You can also open the Area window using the [Area] command in the [View] menu.

The following objects can be arranged in the Area window:

- Zone
- External Device
- Picture
- Text
- Box
- Ellipse
- Wire

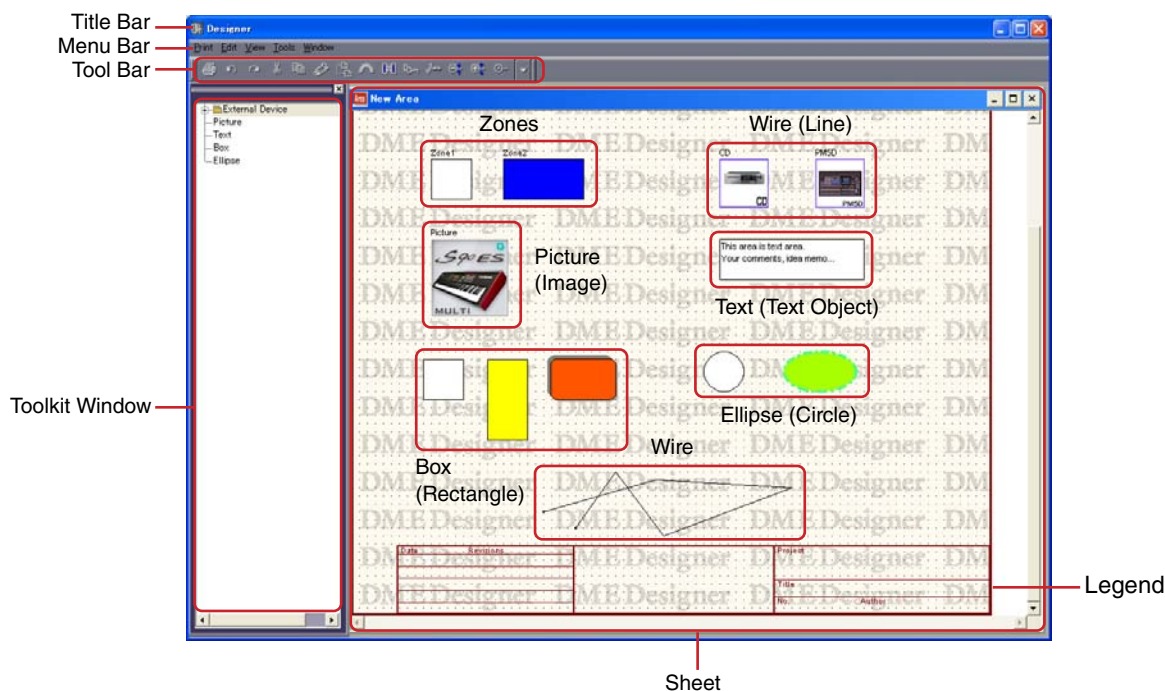

■ Title Bar

You can move windows by dragging the title bar.

■ Zone

Zones are added and deleted using the “Zone Manager” dialog box. You cannot perform operations such as deletion, cut, or copy. You can change the position and design of zone objects in the Area window. Double-click to open a Zone window.

■ Objects

Various types of objects can be placed, cut, copied, pasted, deleted, moved, and manipulated in other ways.

■ Legend

Double-click “Legend” to show the “Edit Legend” dialog box where the title fields can be edited.

Arranging Objects

Various types of objects can be placed in the window by dragging them from the Toolkit window. You can also place objects by double-clicking them in the Toolkit window. You can also display the [Area Parts List] from the [Tools] menu or from the context menu that appears when you right-click on the sheet.

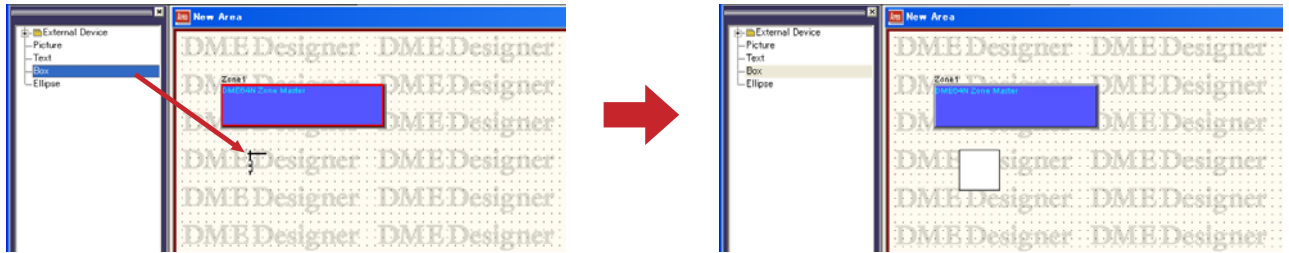

Zone Window

In the Zone window, the zone configuration is designed by arranging zone devices on a design sheet. A zone configuration can be created that is the same as the actual hardware arrangement.

To display the Zone window, double-click in the Area window. When you click a configuration in the Navigator window, it becomes active.

The following objects can be arranged in the Zone window:

- DME
- ICP
- SP2060
- External Device
- Picture
- Text
- Box
- Ellipse (Circle)

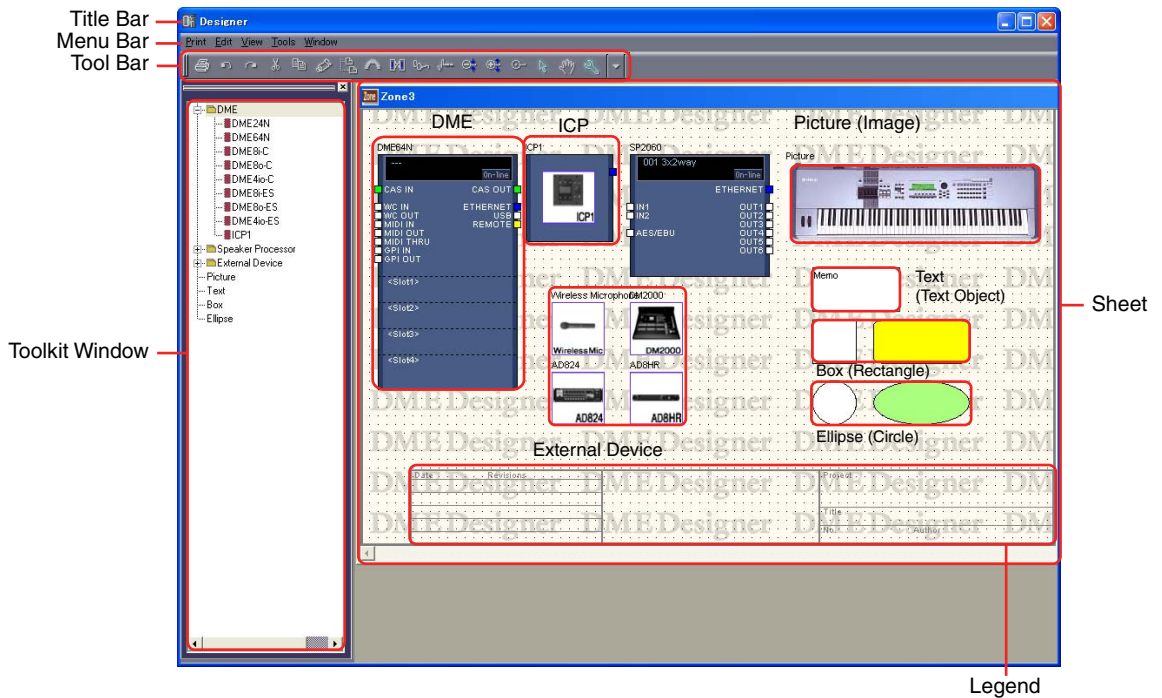

■ Title Bar

Displays the zone name you have in the “Zone Manager” dialog box. There is always one zone named [Zone 1] in a newly created project.

■ Configuration

You can create multiple configurations within a zone, but they cannot be arranged within the Zone window. The devices can be arranged in the Zone window common to multiple configurations. To switch configurations, click the desired configuration in the Navigator window.

You can add, delete, and rename configurations in the “Configuration Manager” dialog box.

■ Objects

You can perform edit operations such as place, cut, copy, paste, delete, and move to devices and shapes. If you double-click on a device arranged in the window, a Configuration window or dialog box will open.

Device	Action When Double-Clicked
DME/SP2060	Displays Configuration Window.
ICP	Displays “Control Panel Properties” dialog box. (Double-click the label)
External Device	Opens external application linked to the device.

Arranging Objects

You can place objects by dragging them from the Toolkit window. You can also place objects by double-clicking them in the Toolkit window. The same objects are displayed in the [Device List] submenu on the context menu that appears when you right-click the [Tools] menu or on the sheet. For information about the “Device List,” see [page 201](#).

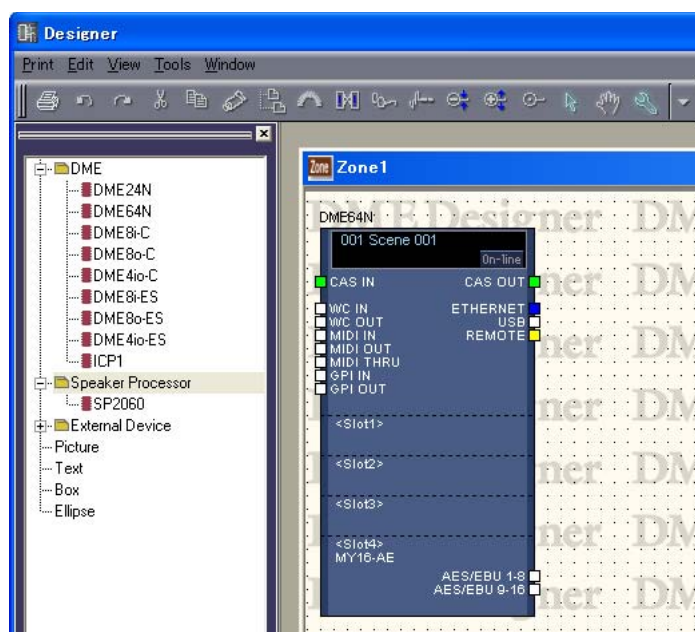

■ Placing DME or SP2060

In the Toolkit window [DME24N], [DME64N], [DME8i-C], [DME8o-C], [DME4io-C], [DME8i-ES], [DME8o-ES], and [DME4io-ES] icons are located in the [DME] folder, and an [SP2060] icon is located in the [Speaker Processor] folder. These icons can be dragged to the zone window.

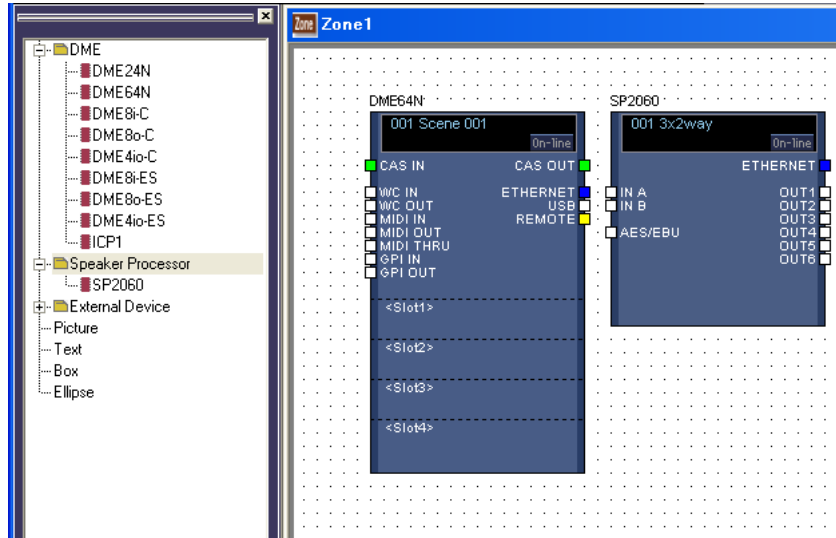

■ ICP Placement

Just like for a DME or SP2060, placing an ICP is to drag the icon from the Toolkit window. If there are multiple ICPs in a hardware configuration, create an equivalent number of ICP objects.

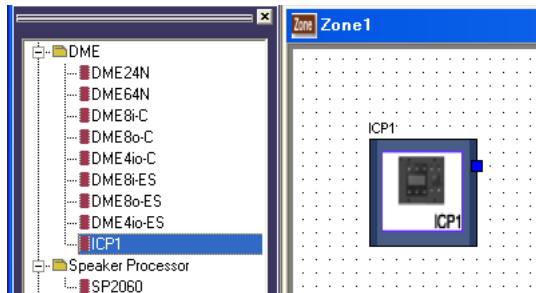

In the Toolkit window [ICP1] icons are located in the [ICP1] folder. This icons can be dragged to the zone window.

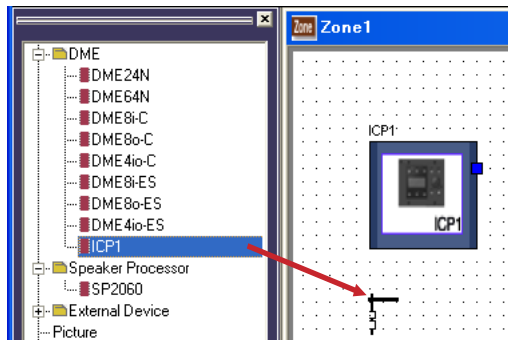

Configuration Window

The Configuration window is used for arranging components on the sheet and making logical connections. It is displayed when you double-click on a DME or SP2060.

NOTE

SP2060 configurations cannot be edited.

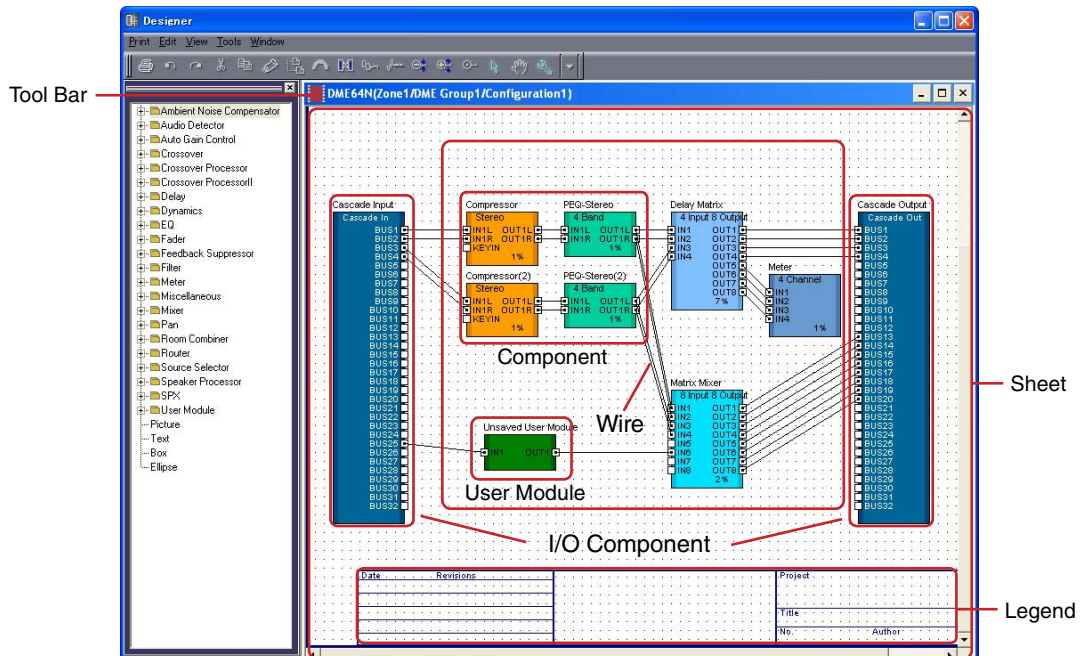

Title Bar

Displays “Device name (Zone name/Device Group name/Configuration name).” The configuration window using Configuration1 for a DME64N placed in Device Group1 of Zone1 will be “DME64N (Zone1/DME Group1/Configuration1).” The device name is set in the properties for the device placed in the Zone window.

Objects

Objects such as components, user modules, and shapes are arranged in the Configuration window. When you double-click a component placed in the window, the editor set in “Double Click Action” in “User Module Properties” will open.

I/O Component

Depending on the settings for the DME placed in the Zone window, I/O components will be automatically placed or added.

- I/O components can be arranged in the DME24N, DME Satellite and SP2060 configuration window.
- When “Show Cascade Port” is ON in the DME64N “DME Device Properties” dialog, Cascade I/O is added automatically.
- When you set a slot in the properties for a DME placed in the Zone window, Slot I/O will be automatically added.

You cannot apply edit operations like cut/copy/paste/duplicate to I/O components, Slot I/O, and Cascade I/O.

Placing Components

You can place objects by dragging them from the Toolkit window. You can also place objects by double-clicking them in the Toolkit window. The same objects are displayed in the [Component List] submenu on the [Tools] menu or on the context menu that appears when you right-click on the sheet. For information about the [Component List] in the Configuration window, see [page 201](#).

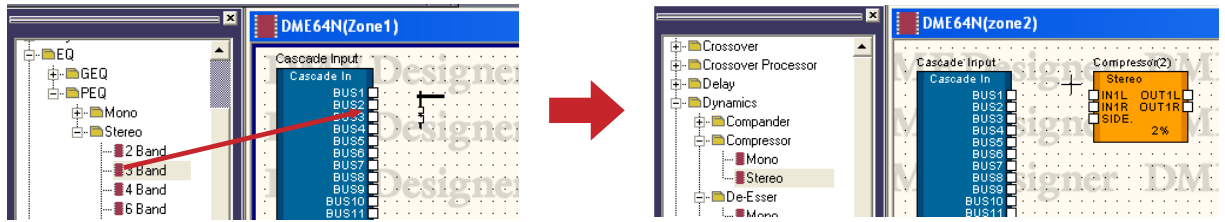

NOTE
The components that can be placed in the configuration window vary according to the device type. For details, see “Component List” on [page 372](#).

NOTE
If the [Matrix Mixer 64 input 64 output] or the [Matrix Mixer 64 input 32 output] components are placed in the DME64N configuration window, you will not be able to use other components, even though the window does not reach 100 percent. The [Matrix Mixer 64 input 64 output] or [Matrix Mixer 64 input 32 output] components cannot be used in the DME24N and DME Satellite.

■ Arranging a Number of Components of the Same Type

You can arrange a number of components of the same type. If there are two or more of the same component, numbers will be attached to their names as follows: “Compressor (2),” “Compressor (3)” and so on. Multiple components placed in the configuration are independent, and you can set different parameters for each of them.

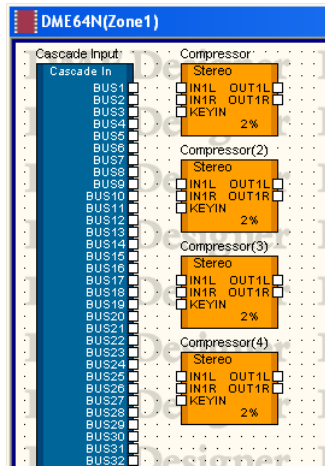

■ SP2060 Configuration Window

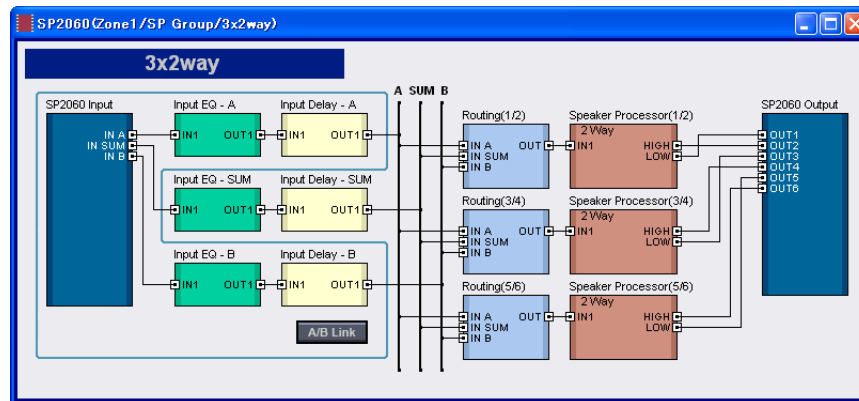

[Input A/B Link] Button

Although SP2060 configurations cannot be edited, the [Input A/B Link] status can be changed. Clicking this button alternately turns INPUT A/B linking ON and OFF. When switched ON the input level, EQ, and Delay component parameters are copied from Input A to Input B, and are thereafter linked.

Probe Monitor

Probe monitor is a function that lets you monitor output ports in your configuration with headphones. You can turn it ON or OFF using [Probe Monitor] in the [Tools] menu or the [Probe Monitor] button on the toolbar. The probe monitor can be set to ON or OFF for each DME64N/24N.

The probe monitor can be used only when online with the DME64N/24N and Configuration window or user module active.

NOTE

DME Satellite and SP2060 do not support the probe monitor.

■ Probe Monitor Procedure

- 1 Turn the probe monitor ON.
Click [Probe Monitor] in the [Tools] menu or the [Probe Monitor] button on the toolbar.
The shape of the mouse pointer changes.

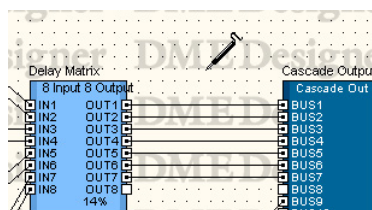

- 2 Click the output port you want to monitor.

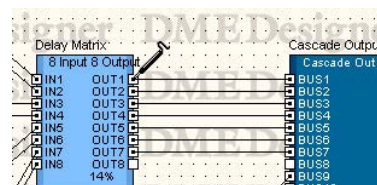

The output port you clicked will be selected and monitoring will begin.

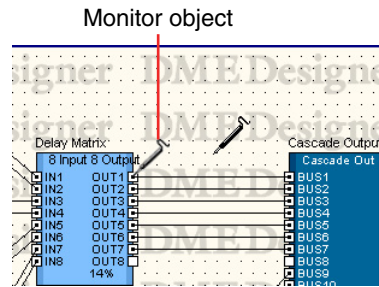

If you click another output port, the location being monitored will change.

■ L/R Selection

To monitor the left channel and right channel simultaneously, <Shift> + click on the left channel, then do the same for the right channel.

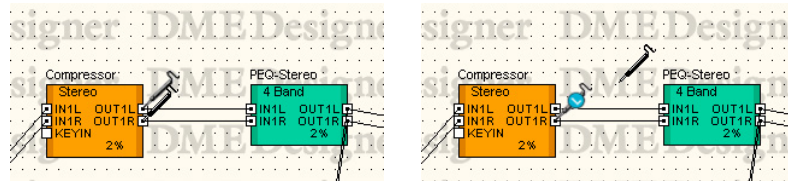

■ Exiting the Probe Monitor

Click [Probe Monitor] in the [Tools] menu or the [Probe Monitor] button on the toolbar to turn OFF the probe monitor. When probe monitor is turned off, the mouse pointer returns to its normal shape.

■ Monitoring the Second or Later Time

The software remembers the location being monitored even when probe monitoring is turned OFF. The next time probe monitoring is turned ON, the location that was being monitored previously will be selected.

NOTE

When you go offline probe monitoring is disengaged and the monitor point will not be restored when you go online again.

Show Signal Delay (Delay Display Value)

The signal delays according to the processing time in the audio processor. The [Show Signal Delay] command from the [Tools] menu calculates a delay value and displays it for the component. Selecting this command switches delay value display between ON and OFF. The mark is lit when display is turned ON.

When turned ON, the settings are compiled to obtain a delay value, which is displayed for components and lines. The delay value obtained through compilation remains valid until the configuration is edited. Sample units are used to display the delay value.

This is linked with the [Show Signal Delay] button on the toolbar.

ON and OFF settings for [Show Signal Display] are saved for each configuration window. Switching the setting between ON and OFF in another configuration window has no effect on the current window. If you edit the configuration while [Show Signal Delay] is turned ON, it will be automatically turned off.

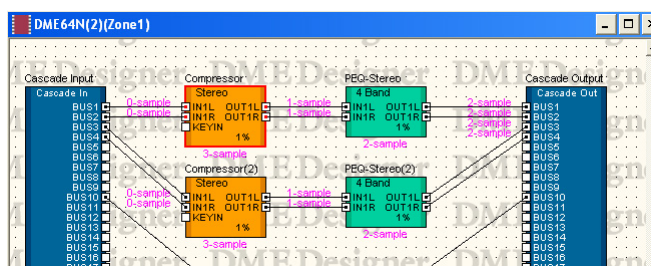

When you turn ON [Show Signal Delay], the delay value appears above the object.

Delay values for components and I/O components are displayed at the lower center of the object.

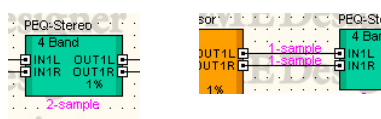

Delay values for wires are displayed beside the input port of the connected object.

NOTE

Delay values for SPX components vary depending on the Bypass ON/OFF status, because SPX components add the effect signal to the original signal. When [Show Signal Delay] is turned ON, the delay value for the Bypass ON status will be displayed.

NOTE

Delay values for Wav File Player components are displayed for external inputs. Delay values for local Wave files cannot be displayed.

NOTE

If there is an obvious problems with the connections the "Some errors occurred while compiling. Please try Analyze, and the error of the reason is displayed" error message will appear. Use the "Analyze" dialog box to determine the reason for the error.

NOTE

A progress bar will appear during compilation, but in some cases it may not exactly match the progress of the compilation process. Also, the appearance of the progress bar is no guarantee that compilation will be completed successfully. If compilation continues for an inordinately long period of time, click the [Abort] button to stop processing. Try eliminating unnecessary components and connections, and replacing components that place a heavy load on resources with more efficient ones, then compile again.

Monitoring Point List

When you click [Monitoring Point List] in the [Tools] menu, the “Monitoring Point List” dialog box is displayed. This allows registering and editing “monitoring points” that can be monitored via the DME64N/DME24N PHONES jack. Monitoring points can be specified not only at the slot and analog inputs and outputs, but also at points between the components.

NOTE

Monitoring points can be edited only by users for whom the [Edit] security checkbox has been turned ON.

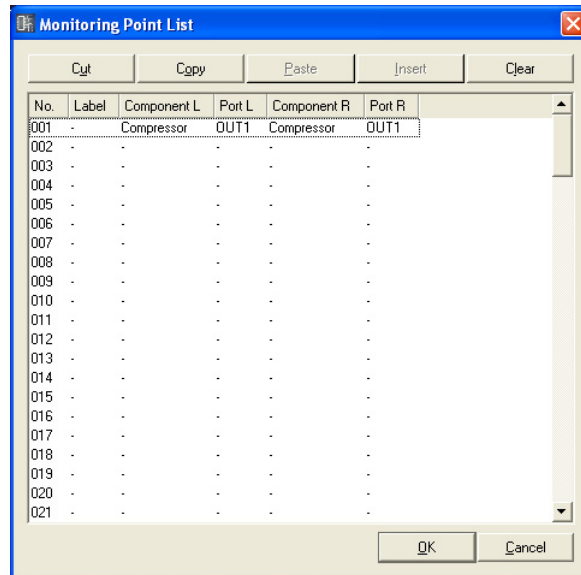

■ [Cut] Button

Cuts the selected monitoring point information. When monitoring point information is cut, information below that point moves up.

■ [Copy] Button

Copies the selected monitoring point information.

■ [Paste] Button

Pastes the copied monitoring point information at the selected line.

■ [Insert] Button

The copied monitoring point information is inserted at the selected point.

■ [Clear] Button

Deletes the selected monitoring point information.

■ Monitoring Point List

Displays and allows editing of monitoring point information.

[No.]

Displays the numbers for monitor link points. Numbers are assigned in order from the top.

[Label]

Displays and allows editing of monitoring point names. Clicking here selects the text. You can then enter a new name.

[Component L]

Sets the monitoring point L channel component. Clicking here displays a list of components arranged in the active configuration window. You can then select components for monitoring.

NOTE

Components arranged in user modules are also displayed in the list. However, components for user modules for which security is set will not be displayed.

[Port L]

Sets the monitoring point L channel port. Clicking here displays a list of ports for the component selected in the [Component L] field. Click the port you want to monitor.

NOTE

If you click a port in the designer window while the "Monitoring Point List" dialog box is displayed, the port will be registered to the monitoring point of current selected row. If you will register the monitoring points as stereo, click a port while holding down the <Shift> key to register Component L and Port L, then click a port again while holding down the <Shift> key to register Component R and Port R. If you will set Label automatically, click a port while holding down the <Ctrl> key to assign the component name and port name to Label.

[Component R]

Sets the monitoring point R channel component. Clicking here displays a list of components arranged in the active configuration window. You can then select components for monitoring.

NOTE

Components arranged in user modules are also displayed in the list. However, components for user modules for which security is set will not be displayed.

[Port R]

Sets the monitoring point R channel port. Clicking here displays a list of ports for the component selected in the [Component R] field. Click the port you want to monitor.

■ [OK] Button

Updates the settings and closes the dialog box.

■ [Cancel] Button

Closes the dialog box without changing the settings.

Analyze (Configuration Analysis)

When you click the [Analyze] command on the [Tools] menu or the [Analyze] button on the toolbar, the “Analyze” dialog box is displayed. The wire connections in the currently active configuration window are analyzed, and the results are displayed in the “Analyze” dialog box. Because this function allows you to make sure there are no problems with component arrangement and wires without connecting to the DME unit, it is useful for eliminating compiler errors before executing Synchronization.

NOTE

The [Analyze] command on the [Tools] menu can be selected only when a configuration window is active.

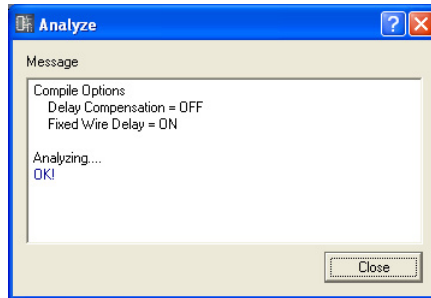

■ **Message Box**

Displays the progress of the analysis operation. When the analysis finishes, the results are displayed. If errors are detected during analysis, they will display as shown below.

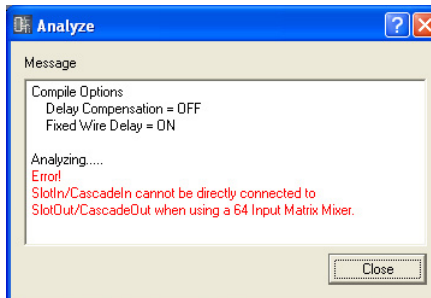

■ **[Close] Button**

Closes the dialog box.

■ **Progress Bar**

A progress bar will appear during analysis, but in some cases it may not exactly match the progress of the analysis process. Also, the appearance of the progress bar is no guarantee that analysis will be completed successfully. If analysis continues for an inordinately long period of time, click the [Abort] button to stop processing.

NOTE

If the analysis process fails, try eliminating unnecessary components and connections, and replacing components that place a heavy load on resources with more efficient ones, then run the analysis again.

NOTE

Once a configuration has been analyzed or compiled successfully, subsequent analysis or compilation will run quicker unless changes are made to the configuration. Also, if you save the project file the analysis/compilation data is saved as well.

User Module

User Modules

A module treated as a single component that combines a number of other components is called a “**user module**.” A user module can be arranged in the Configuration window just like any other component. User module editing consists of placing the component and making logical connections with wires, the same as for configurations.

Saved user modules are displayed in the Toolkit window and can be used as templates. User modules are saved in project files, but user module templates can also be exported as files and used in other projects.

A “UserModule” folder will be created in the folder specified in [Contents Folder] in the “Preferences” dialog box in the Main Panel window. User modules will be saved there.

Refer to “User Module Editor” on [page 330](#) for more information on the dedicated user module control window.

NOTE

The Main Panel Menu “Preferences” dialog box is displayed using [Preference] in the [File] menu.

Creating User Modules

When you place a blank user module in the Configuration window, a new user module is created. When the project is saved, the user modules are also saved in the project file.

- 1** Make the Configuration window active.
- 2** Click the [+] next to [User Module] in the Toolkit window.
The items in the level below the [User Module] folder will be displayed.
- 3** Drag the [Blank User Module] to the Configuration window.

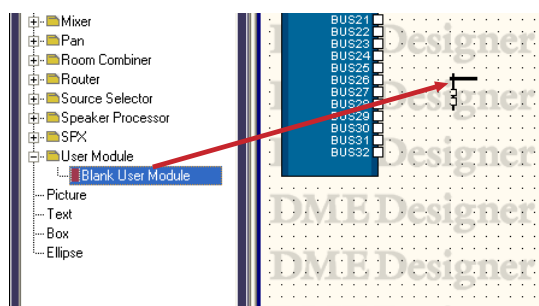

When you release the mouse button at the location where you will place the user module, the “User Module Properties” dialog box is displayed.

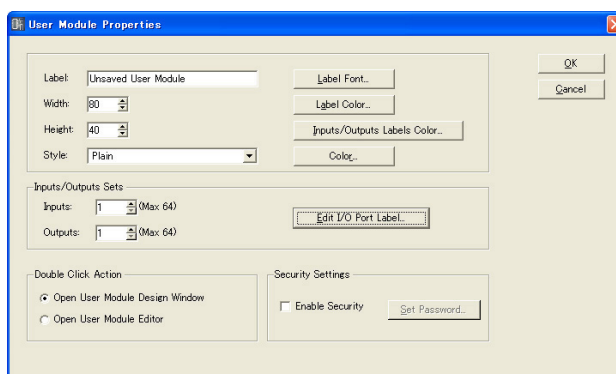

4 Here you can set object properties.

[Inputs/Outputs Sets] is set to 1. Set the required number of ports.

5 Click the [OK] button.

A user module will be created, and placed in the Configuration Design window.

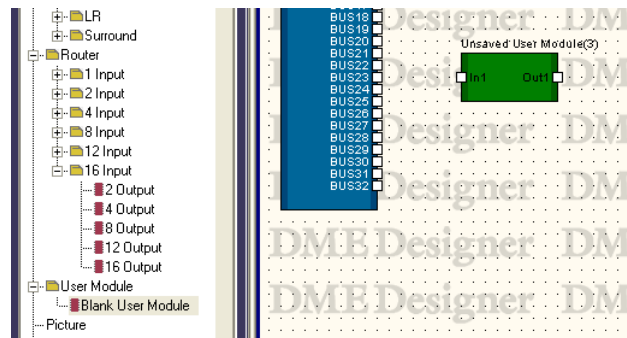

The user module properties can also be changed later. For information about the “User Module Properties” dialog box, see [“User Module” on page 243](#).

Saving User Modules

When user modules are saved using the [Save User Module] command, they are displayed below [User Module] in the Toolkit window and can be used as templates.

- User modules placed in the configuration window can be saved with project files, but user module templates are saved as files in a specific folder on the computer.
- User module templates can be exported and imported as user module template files. The export file includes the component wiring/connection, library, and user module editor data.
- If a user module template is placed in the configuration window and then edited and saved with a project file, the template will not be changed. Using the [Save User Module] command you can either overwrite the original template or save the template with a new name.
- User modules created from templates use the same library as the original template. User module templates that use the same library are categorized as a “user module group.” User module templates are displayed in the appropriate group in each window.
- If a project is opened on a different computer, only user modules placed in the configuration window will reappear. Export and import the data as a DME Designer All file in order to reproduce the user module templates as well.

NOTE

Parameter links (local links) and component links are saved with user modules.

Save the User Module using the [Save User Module] command on the [Tools] menu. The [Save User Module] command can be used only when a user module is selected in the Configuration window. When you select the command, the “Save User Module” dialog box will be displayed. Enter a name for the User Module, then click the [OK] button.

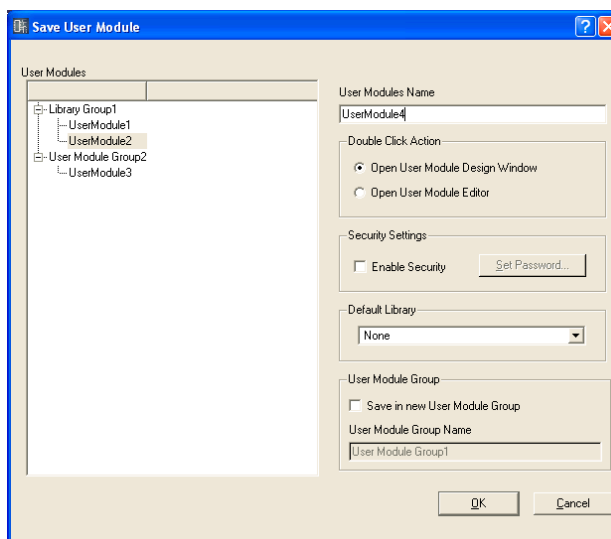

Set [Double Click Action], [Security Settings], [Default Library], and [User Module Group] at the right part of the “Save User Module” dialog box.

They correspond to the same items in the “User Module Properties” dialog box. When saved with different settings than the “User Module Properties” dialog box, the saved settings are immediately applied.

■ Double Click Action

Initial setting of the window that opens when you double-click on a user module placed in the component editor.

[Open User Module Design Window]

Opens the User Module Design window.

[Open User Module Editor]

Opens the User Module editor.

■ Security Settings

Initial settings of user module security.

[Enable Security]

Enables user module security.

If you place a checkmark here, the “Set Password” dialog box appears. Enter the same password into the [Password] box and [Confirm Password] box, and click the [OK] button.

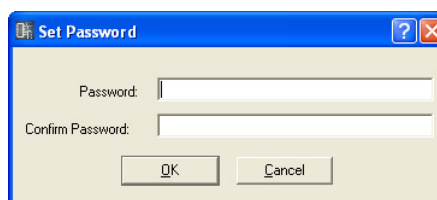

[Set Password] Button

Changes the password. Clicking here displays the “Input Password” dialog box. Enter the current password and click the [OK] button. The “Set Password” dialog box will be displayed. Enter the same password into the [Password] box and [Confirm Password] box, and click the [OK] button.

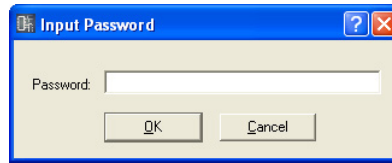

■ Default Library

Specifies the library file to be imported when creating a user module from a template. Refer to “Library” on [page 364](#) for information.

■ User Module Group

Sets the user module group (a group of user modules that use the same library).

When saving a new user module, enter a name for the user module group in the User Module Group Name field.

When saving a user module created from a template you can specify whether it is saved in the same group as the original template or a new group. To save the user module in a new group check the [Save in New User Module Group] checkbox, and enter the name of the new group in the User Module Group Name field.

If you try to save a user module with the same name as an already saved user module, a message asking “xxxxx already exists. Do you wish to overwrite it?” will be displayed. To overwrite, click the [Yes] button. To abort saving, click the [No] button to close the “Save User Module” dialog box. To change the name, click the [Cancel] button, and change the file name in the “Save User Module” dialog box.

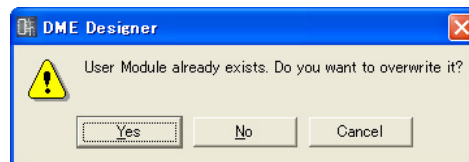

NOTE

When the “Save User Module” dialog box is displayed, the name set in the user module’s “User Module Properties” dialog box will be entered into the [File name] box. If you change the name of a user module and save it using the “Save User Module” dialog box, the filename in the user module and the user module name displayed in the Toolkit window will also change.

The [Label] box displayed in the “User Module Properties” dialog box will not change.

Editing User Modules

User modules can be edited in the User Module window. Components layout and logical connections are set up in the design worksheet. The design worksheet can be opened by selecting [Open User Module Design Window] from the contextual menu of user modules in the configuration window. If [Open User Module Design Window] is selected as the [Double Click Action] in the “User Module Properties” window, the design worksheet can also be opened by double-clicking a user module. → “User Module Properties” (page 245).

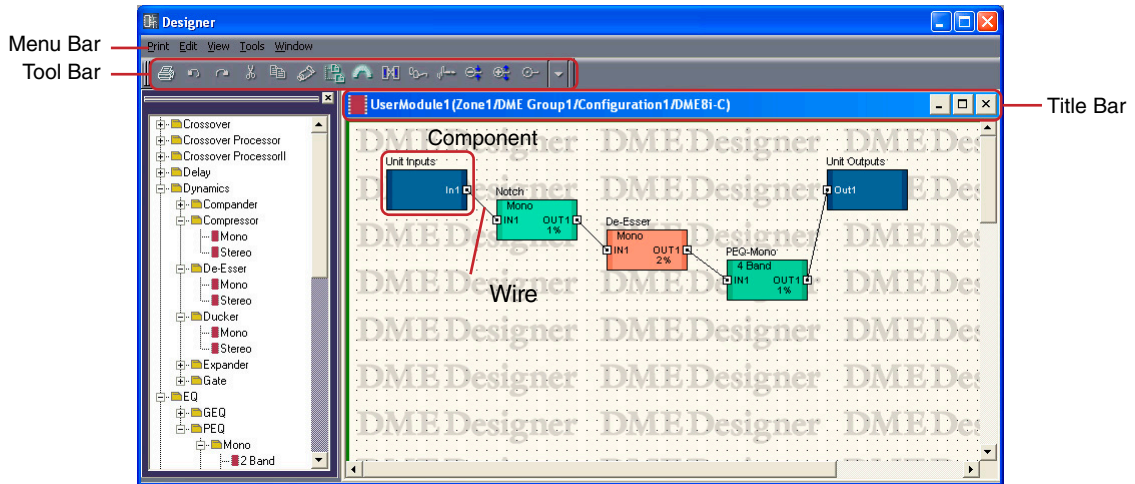

Title Bar

The user module name (Zone name/Device Group name/Configuration name/Device name) is displayed on the title bar. User module names are set in the “User Module Properties” dialog box.

Objects

You can place, cut, copy, paste, delete, and move component and shape objects. When you double-click an object placed in the window, the component editor will open.

Placing Components

Components are placed the same as in the Configuration window.

You can place objects by dragging them from the Toolkit window to the User Module window. You can also place objects by double-clicking them in the Toolkit window. The same objects are displayed in the [Component List] submenu on the [Tools] menu or on the context menu that appears when you right-click on the sheet.

For information about the User Module window [Component List], see page 202.

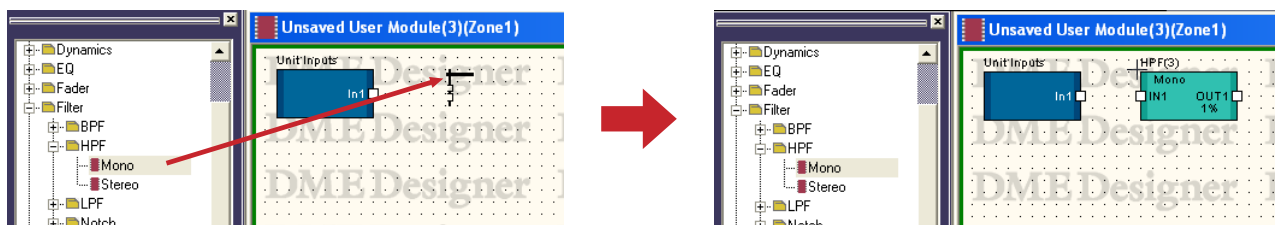

■ Placing a Number of Components of the Same Type

You can arrange a number of components of the same type. If there are two or more of the same component, numbers will be attached to their names as follows: “Compressor (2),” “Compressor (3)” and so on. Multiple components placed in the configuration are independent, and you can set different parameters for each of them.

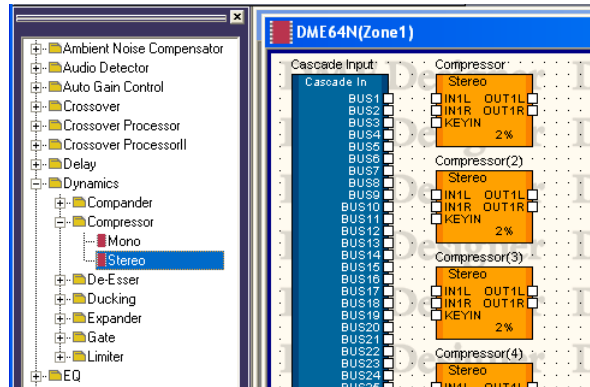

User Module Manager

When you click [User Module Manager] on the [Tools] menu, the “User Module Manager” dialog box is displayed. Edits, renames and deletes user module templates.

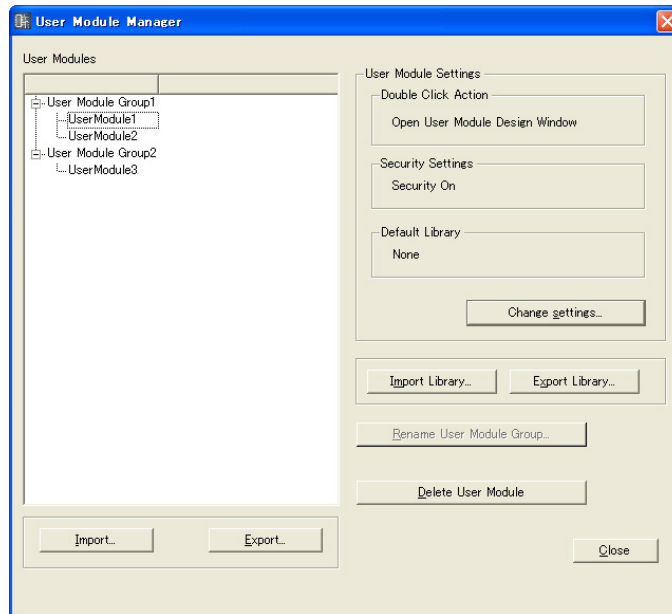

■ User Modules

User modes saved as templates are displayed in the list. Select the target user module by clicking on it.

NOTE
Only user modules saved can be displayed. User modules placed in the component editor are saved in project files, and can be used without being saved as files. However, they will not be displayed in the “User Module Manager” dialog box list.

NOTE
When a user module to which security has been applied is selected, a password will be required for all operations other than [Delete] and [Import].

■ User Module Settings

Displays the settings for the user module selected on the list. To change the settings, click the [Change settings] button to open the “User Module Settings” dialog box (page 316).

Double Click Action

Displays the default action when user modules in the configuration window are double-clicked.

Security Settings

Displays the security setting for the user module selected on the list.

Default Library

Displays the default library file for newly-created user modules.

■ [Import Library] Button

Loads a file from the specified folder into the library.

■ [Export Library] Button

Saves the library to a file.

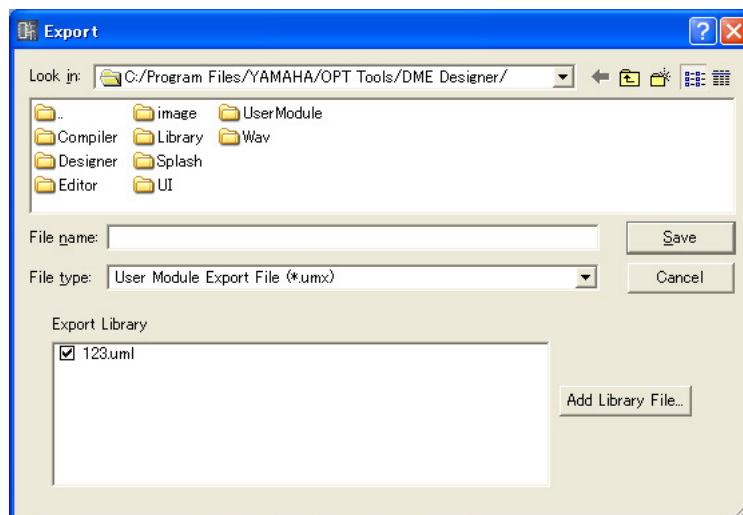

■ [Rename User Module Group] Button

Changes the User Module Group name selected on the list. Click this button to open the “Rename User Module Group” dialog box, enter the group name at the [Name] box, and then click [OK].

■ [Delete User Module] Button

Deletes the user module selected on the list.

■ [Import] Button

Imports the user module settings and library from the user module export file.

■ [Export] Button

Saves the user module data (component wiring/connection, library, and user module editor data) to a user module export file.

Click to display the Export dialog, All features of this dialog window are the same as the standard Windows file save dialog, except for the [Export Library] option.

[Export Library] can be sued to select the library to be saved.

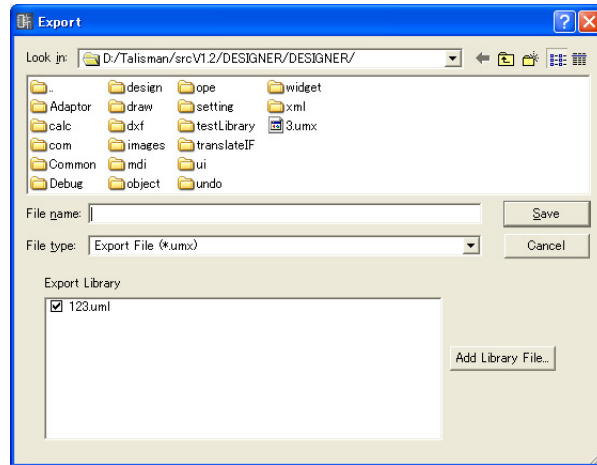

■ [Close] Button

Closes the dialog box.

“User Module Settings” Dialog Box

Click the [Change Settings] button in the “User Module Manager” dialog box to open the “User Module Settings” dialog box. Here you can edit the user module template name, group name, and security settings.

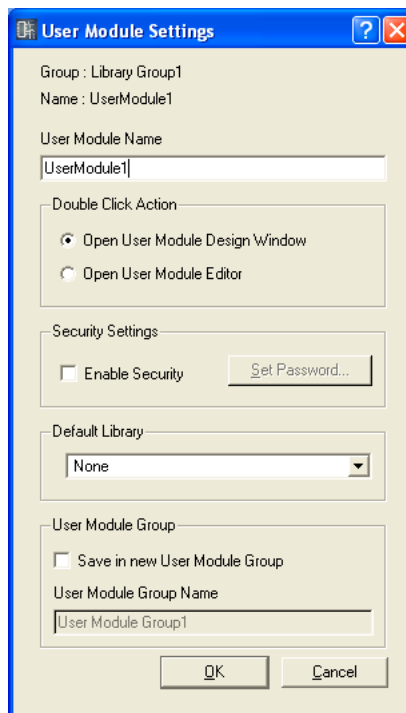

■ Group/Name

Displays the pre-edit user module group name and user module name.

■ User Module Name

Specifies the user module name.

NOTE

Since the user module name is used as a file name, characters that cannot be used for file names cannot be used for user module names.

■ Double Click Action

Specifies the default action when user modules in the configuration window are double-clicked.

[Open User Module Design Window]

Opens the User Module Design window.

[Open User Module Editor]

Opens the User Module editor. The user module editor is a window where controls for components that are placed in a user module can be laid out and their parameters changed. For more information about the user module editor, see [“User Control Editor”/User Module Editor](#) on page 325.

■ Security Settings

Makes security initial settings for the user module selected on the list.

[Enable Security]

Enables user module security. If security is enabled, a password is requested when attempting to open the User Module window. If the correct password is not entered, the window will stay closed. When you place a checkmark here, the “Set Password” dialog box appears. Enter the same password into the [Password] box and [Confirm Password] box, and click the [OK] button.

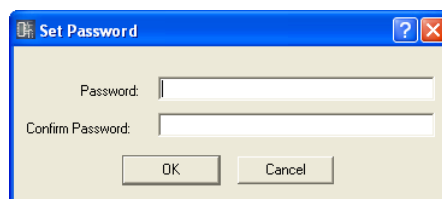

To disable user module security, turn OFF the checkbox. If you click the checkbox when it already has a checkmark, the “Input Password” dialog box appears. Enter the password set for this user module, and click the [OK] button. You can disable security in this way. If you do not enter the correct password, you will not be able to disable security.

[Set Password] Button

Changes the password. Clicking here displays the “Input Password” dialog box. Enter the current password and click the [OK] button. The “Set Password” dialog box will be displayed. Enter the same password into the [Password] box and [Confirm Password] box, and click the [OK] button.

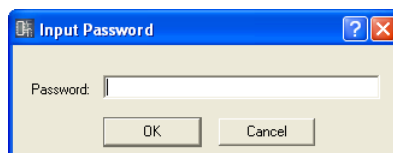

■ Default Library

Specifies the library file to be imported when creating a user module from a template. Refer to “Library” on [page 364](#) for information.

■ User Module Group

Sets the user module group. To change the user module group, check the [Save in New User Module Group] checkbox, and enter the name of the new group in the User Module Group Name field.

NOTE

User module groups cannot be changed to an existing group.

NOTE

If the user module group is changed without changing the user module name, no libraries can be referenced. To use a new library you will also need to change the user module name.

■ [OK] Button

Applies the settings and closes the dialog box.

■ [Cancel] Button

Closes the dialog box without changing any settings.

Chapter 5 Editor Window

Component Editor Window

Component parameters are edited in the component editor. The same component can be placed multiple times on the same sheet in a Configuration or User Module window. If there are multiple examples of the same component in a configuration window or user module window, each component is independent and its parameters are set individually in a separate Component Editor window. When you double-click on a component located in a Configuration window, the Component Editor window will open. There is not just one window that is called the component editor. The contents of the editor and the name on the title bar will differ according to type of component for which the window was opened.

Names and Functions

The contents of the Component Editor window vary according to the component.



■ Title Bar

Displays the label. Label settings are made in the “Component Properties” dialog box. For information about component labels see “Component” (page 235) in “Objects.”

■ Back Button

This button appears in the child window of windows that have a parent-child relationship, and can be clicked to return the parent window.

■ Status Bar

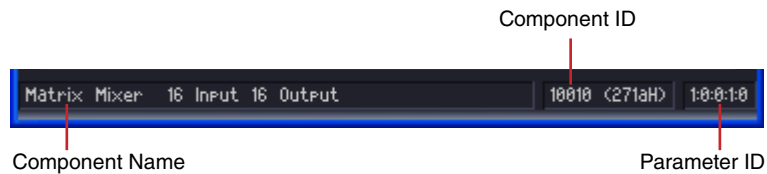

Component Name

Displays the component name.

Component ID

Displays the component ID.

NOTE

When controlling the DME64N/24N by connecting an RS-232C compatible controller to the [REMOTE] terminal, a component ID is required for distinguishing the same components in the DME64N/24N. The component ID is included in the signal that controls the component parameters. For details about control methods, contact your nearest Yamaha representative or the authorized distributor at the end of the DME64N/24N Owner's Manual.

Parameter ID

Displays the parameter ID for controls that are being operated.

■ Snap

Up to four component editor parameter sets can be recorded temporarily. You can switch between parameter sets using buttons.

Parameter sets can be copied by dragging and dropping a button onto any other button. Copy can also be carried out from the contextual menu that appears when a button is right-clicked.

→ See “Snap” on page 362

■ Library

Saves and recalls component editor parameter sets as files.

→ See “Library” on page 364.

■ Knob

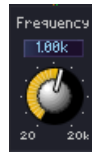

Drag to adjust the parameter.

You can change the way knobs operate, using the [Component Editor] tab → [Knob Mode] setting in the “Preferences” dialog box.

“Preferences” dialog box

→ “Component Editor” tab ([page 73](#))

NOTE

To make a finer setting, press the <Shift> key while dragging the knob when [Knob Mode] is “Linear”.
If you click a knob while pressing the <Ctrl> key, the setting will return to its default value.

■ Slider

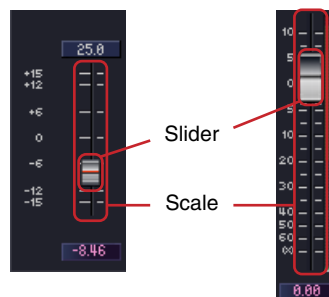

You can change the parameter by dragging the slider.

You can set the action that results from using the mouse on the scale area with [Component Editor] tab → [Slider Mode] in the “Preferences” dialog box.

“Preferences” dialog box → “Component Editor” tab ([page 73](#))

NOTE

To make a finer setting, press the <Shift> key while dragging the slider.
If you click a slider while pressing the <Ctrl> key, the setting will return to its default value.

■ Buttons

There are several types of buttons.

- Switches between ON/OFF. When turned on, the button lights up. The color depends on the button’s function.



When turned ON



When turned OFF

- In button sets of this type, you can select one of several buttons. When you do all other buttons in the set turn off.



- Click here to execute a command.

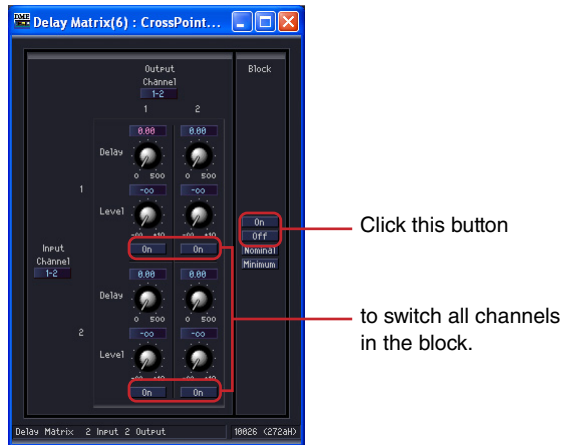

- Displays a menu.

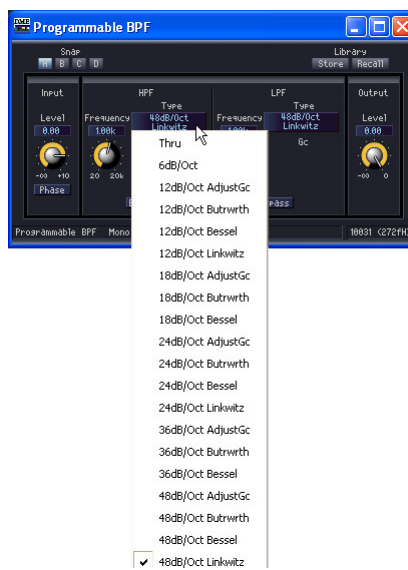

- Displays another window.



■ Edit Box

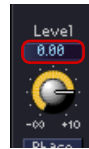

Displays current values for settings. You can modify values by typing from the keyboard or using the mouse. When a value is changed, the knob or slider moves.

Mouse-over

When [Edit Box Zoom] in the [Component Editor] tab of the “Preferences” dialog box is checked, the edit box will zoom when the mouse is positioned over it (mouse-over).

“Preferences” dialog box

→ “Component Editor” tab ([page 73](#))



Click

Text in the selected edit box will turn red. Values can be entered and edited via the keyboard. It is not necessary to enter the unit. Press the <ENTER> key to confirm the entry and display the unit.



Changing Values Using Spin Boxes

When the mouse pointer is placed over an edit box, a spin box appears. Clicking the up arrow [▲] increases the value, while clicking the down arrow [▼] decreases it.

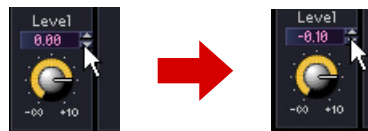

Double-click

Selects a number. You can change the selected number using the keyboard. There is no need to enter units. When you press the <Enter> key, the numbers you entered will be set and the units displayed.



Moving with the <Tab> Key

If you press <Tab> key while an edit box is selected, the selection will move to the next edit box. If you press <Shift> + <Tab>, the selection moves to the previous edit box.

Changing Selections with the Key/Mouse Wheel

You can modify values in selected edit boxes using the direction keys or the mouse wheel.

- **Up and Down Arrow Keys**
Increases or decreases number settings.
- **<PageUp> Key/<PageDown> Key**
Increases or decreases number settings in large increments. The <PageUp> key increases and the <PageDown> key decreases the setting.
- **<Enter> Key**
When you press the <Enter> key, the numbers you entered will be confirmed.
- **<Ctrl> Key + <Enter> Key**
When you press the <Ctrl> + <Enter> key, the setting will return to its default value.
- **Mouse Wheel**
Rolling the mouse wheel upward (away from you) increases the value. Rolling it down (towards you) decreases the value.
- **Dragging**
Dragging upward increases the value, while dragging downward decreases it.
- **<ESC> Key**
The <ESC> key can be used to cancel a value being entered.

■ Graph

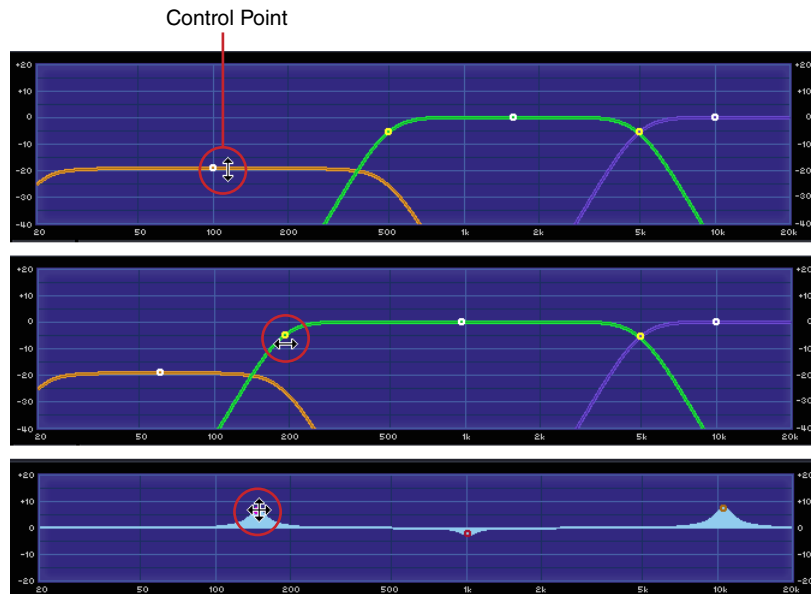

Displays parameters graphically. When parameters are changed, the graph also changes. In graphs that have control points, you can adjust parameters by dragging the points. On graphs with control points that are limited to movement in one direction only, aligning the mouse pointer with the control point and pressing the mouse button causes the mouse pointer to change to a double-headed arrow pointing in both directions of movement. Change the parameter by dragging in the directions of the arrow.

Control points that can be dragged in any direction usually have their position determined by multiple parameters in the component editor. These multiple parameters can be adjusted by dragging the point.

When there are multiple control points in the graph, they are identified by their colors. A bar with the same color as each control point can be found below the corresponding knob or edit box.

NOTE

When a graph that has control points is copied to the User Control Editor or User Module Editor, the controls points will not be displayed. The controllers assigned to the corresponding parameters must also be copied to display the control points.

User Control Editor/User Module Editor

User Control Editor

The user control function lets you lay out a set of component controls in the Configuration window or User Module window, and create a control window with them. The controls in the user control editor are linked to the controls for the original component. If the parameters are changed in the user control editor, the parameters will change in the same way in the component editor. If parameters are changed in the component editor, the controls in the user control window will also change in the same way.

You can create a compact control window by only including controls for parameters that are used frequently.

You can also lay out controls for multiple components, so that you can adjust parameters for them from a single window.

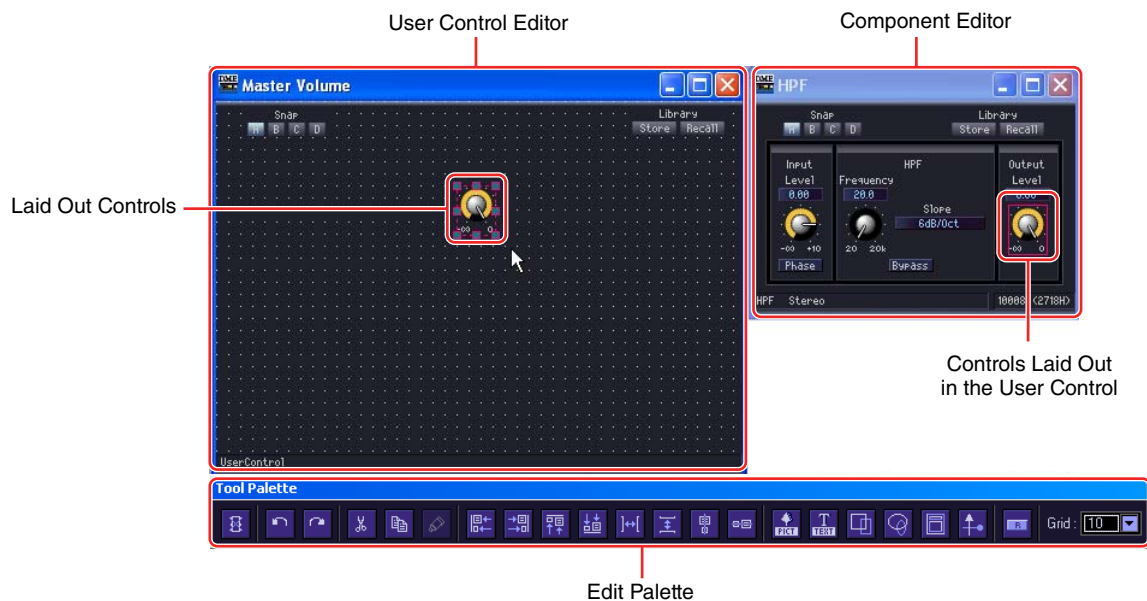

There is also a [Library] button in the user control editor, which you can use to save parameters to the library.

User controls are created by selecting [View] menu → [User Control] → [New User Control] in the Main Panel window. Created user controls are displayed in the [View] menu → [User Control] submenu. If you select one, a window will open for it. The controls which can be opened by the user control editor are automatically set according to the user security settings of the currently logged in user.

■ [User Control] Menu

User controls are displayed in the [View] → [User Control] submenu of the Main Panel window. If you click the [User Control] button in the Main Panel window, you will display the same menu as the [View] menu → [User Control] submenu.



User Control Name

Displays a menu of user controls included in the current configuration of the current zone. Clicking one of the user controls opens the user control editor. A checkmark appears next to already open windows.

New User Control

When you select the “New User Control” command, the “New User Control” dialog box will be displayed.

■ Creating New User Controls

New user controls are added in the “User Control Manager” dialog box.

- 1 Click [User Control Manager] on the Main Panel window [Tools] menu. The “User Control Manager” dialog box will be displayed.

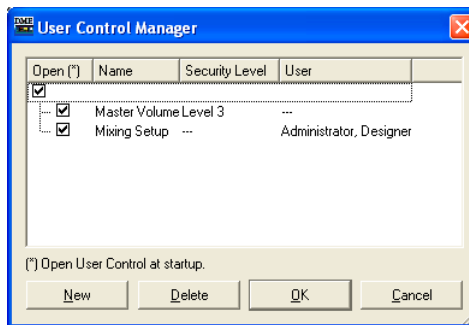

- 2 Click the [New] button.

The “New User Control” dialog box will be displayed.

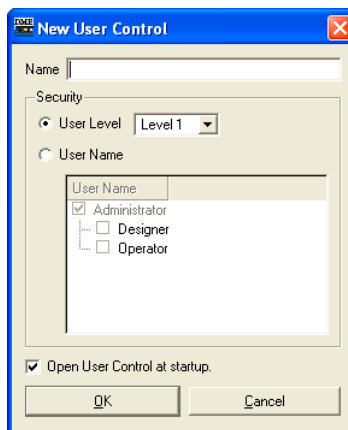

- 3 Enter the name for the new user control into the [Name] box.

4 Sets security for User Control.

Different settings are provided for individual security levels and users. Security cannot be set higher than the user security level.

NOTE

If the [Open User Control at startup] checkbox is checked, the user control will open automatically when the project file is opened.

Click the [User Level] [▼] button to select a security level.

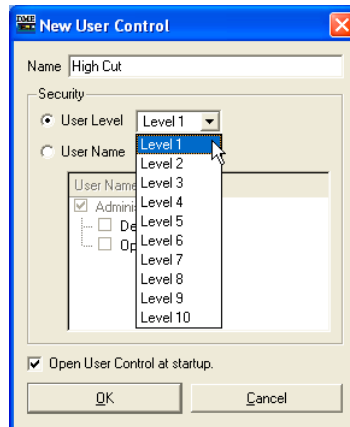

Use [User Name] to select a user.

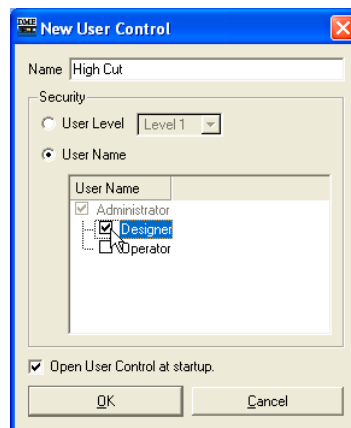

5 Click the [OK] button.

The user control will be created and displayed on the list in the “User Control Manager” dialog box.

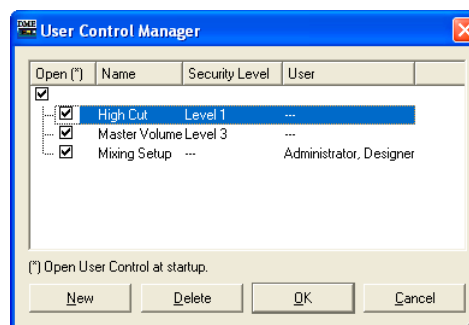

6 Click the [OK] button in the “User Control Manager” dialog box.

When a new user control is created, it will be displayed in the [View] menu → [User Control] submenu in the Main Panel window. If you click the control, it will be displayed in a user control editor window.

[Snap] and [Library] appear appears in a new user control.

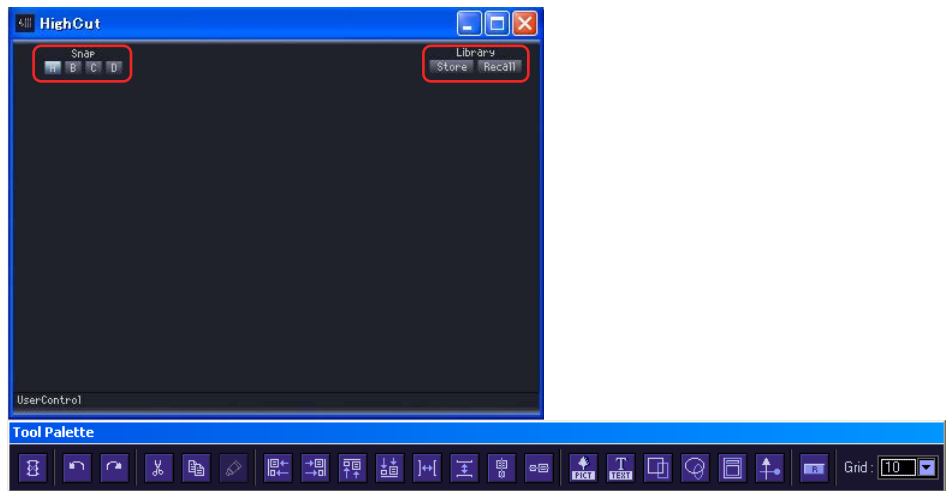

■ User Control Security

Security can be set independently for each User Control. User Control levels higher than the user security level will not be displayed in the menu or the User Control Manager dialog box.

The security level settings for both the user control and the user affect editing and display of user controls.

■ User Control Security Level

Security 1 ~ 10 can be set for each level or user. Level 1 is the highest level and 10 is the lowest.

If the security level for a user control is set to 2, only users at level 1 or level 2 can display or edit it. Security levels for user controls can be changed in the “User Control Manager” dialog box by a user who has logged on at a security level equal to or higher than the user control.

1 Click [User Control Manager] on the Main Panel window [Tools] menu.

The “User Control Manager” dialog box will be displayed.

2 Changing User Control Security

- **To Change the Security level**

Click the [Security Level] box of the User Control to be changed.
The security level list will appear.

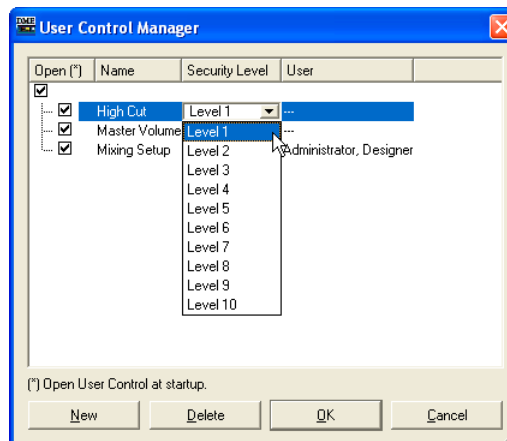

NOTE

The levels displayed on the list will differ according to the security level of the user.

Click the level to be set for the User Control.
The selected level will be displayed in the [Security Level] box.

- **Setting Security for Individual Users**

Click the [User] box of the User Control to be changed.
The user list will appear.

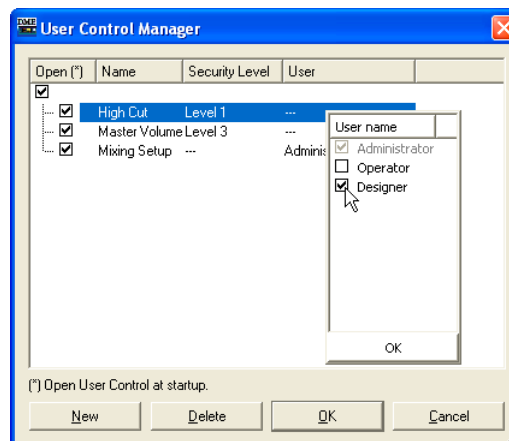

NOTE

The users that can be selected will depend on the user security level.

Click the user to be set for the User Control.
The selected user name will be displayed in the [User] box.

3 Click the [OK] button.

■ User Security Settings

In the “Security” dialog box in the Main Panel window, you can set the user control levels at which to allow or disallow editing and display.

A user can edit user controls if a check has been placed for that user in the [Operation Security] → [Edit] checkbox. User controls at a level equal to or lower than the level set in [Operation Security] → [User Control Level] will be displayed in the menu.

For information about the “Security” dialog box, see “Security (Creating Users and Making User Settings)” on [page 82](#).

User Module Editor

The user module editor lets you make a layout of controls for components arranged in the user module window. For each user module there is one user module editor. The name of the user module is displayed in the title bar. Only components that are arranged in a particular user module can be laid out in the specific control window that is associated with that user module. Both the user module and the control window will have the same name.

Refer to “User Modules” on [page 309](#) for more information about user modules.

NOTE

You can copy controls from a user module to the user control editor.

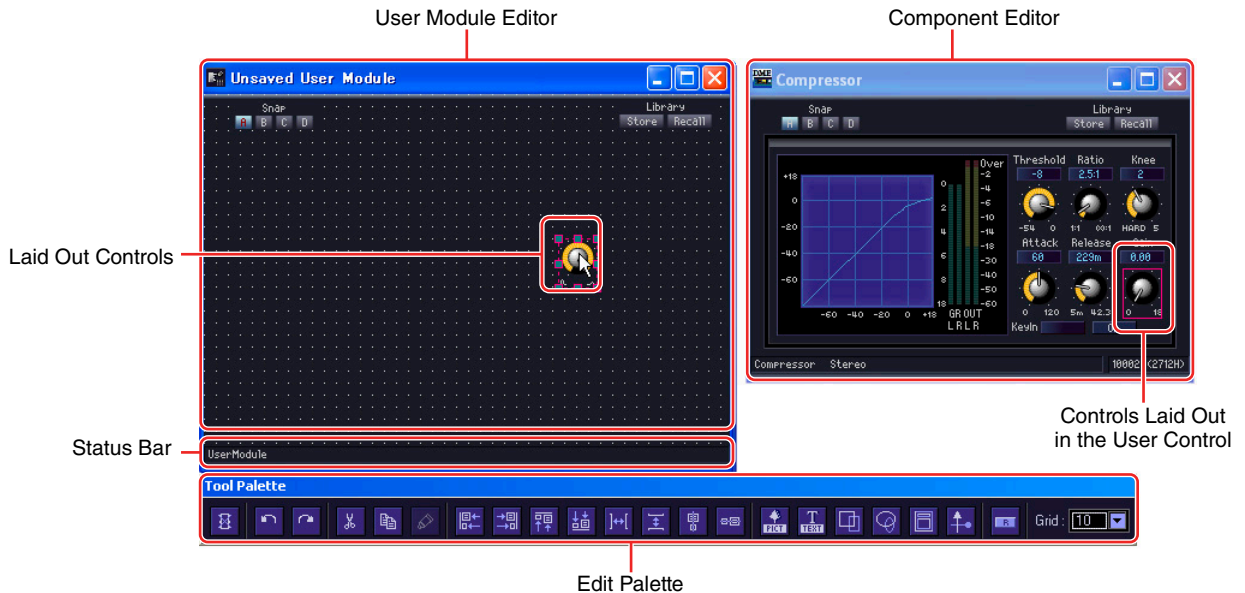

■ Opening a User Module Editor Window

In the designer window, the user module editor can be opened by selecting [Open User Module Editor] from a user module contextual menu. User modules for which [Open User Module Editor] is selected as the [Double Click Action] in the “User Module Properties” window can be opened by double clicking. For information about the “User Module Manager” dialog box, see [page 314](#). For information about the “User Module Properties” dialog box, see [page 243](#).

Names and Functions

■ Status Bar

The lock icon will appear in the User Module when security is active.

→ User Module properties ([page 243](#)).

→ User Module ([page 309](#)).

The lock icon will appear locked when the password has not been entered, and layouts cannot be edited in the Design Mode.

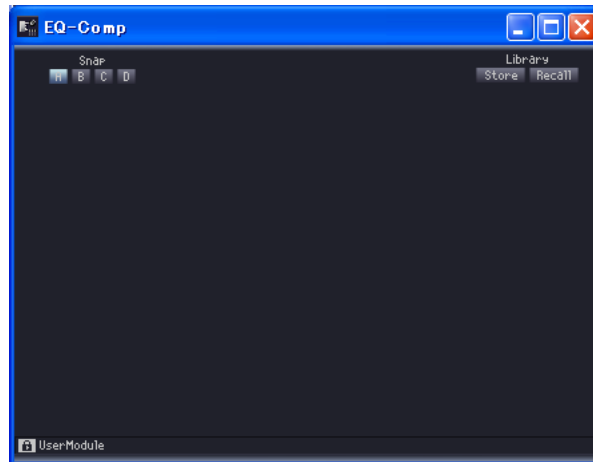

The lock icon will not appear if the [Enable Security] checkbox in the “Properties” dialog box is not checked.

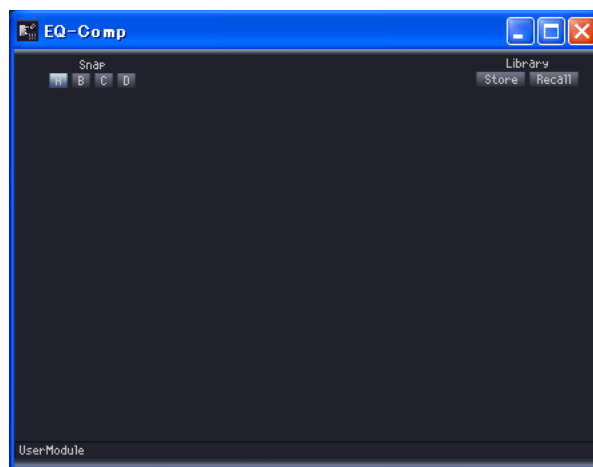

■ Edit Palette

The edit palette is automatically displayed whenever the user control editor/user module editor is active in design mode. Whenever you move the user control editor/user module editor, the edit palette moves together with it. When you turn OFF design mode, the palette disappears. Commands for editing in the user control editor/user module editor are provided on the edit palette.

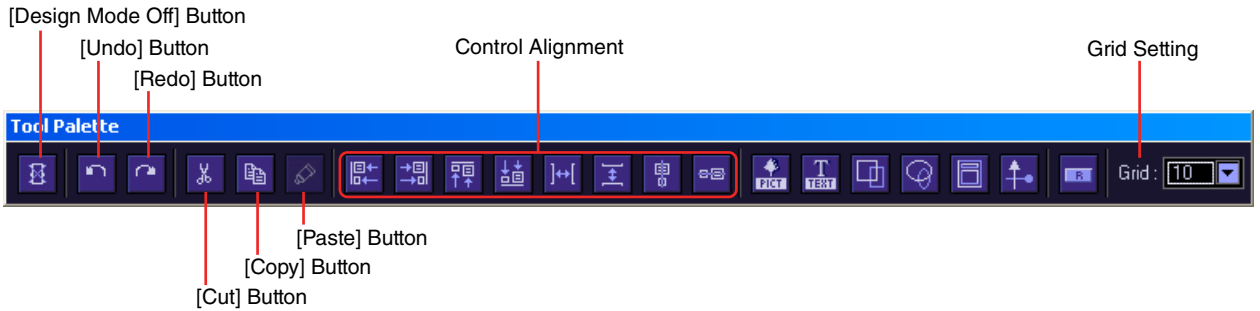

■ [Design Mode Off] Button

Turns OFF the design mode.

■ [Undo] Button/[Redo] Button

Used to undo/redo operations.

■ [Cut] Button/[Copy] Button

Cuts or copies the selected controls.
 → See "Cut/Copy/Paste Controls" on [page 343](#).

■ [Paste] Button

Pastes cut or copied controls.
 → See "Cut/Copy/Paste Controls" on [page 343](#).

■ Alignment of Controls

Aligns the positions of multiple controls.

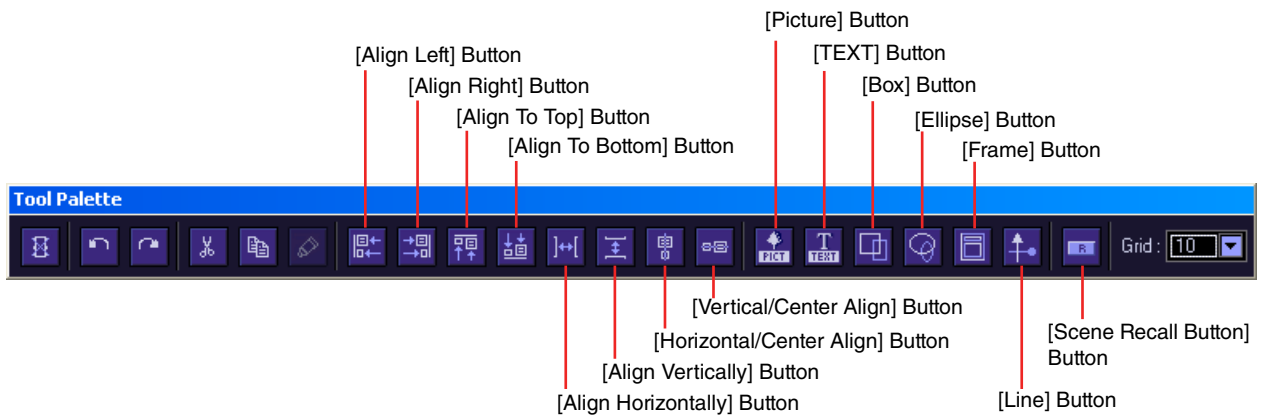

[Align Left] Button

Aligns all selected controls with the left edge of the leftmost selected control.

[Align Right] Button

Aligns all selected controls with the right edge of the rightmost selected control.

[Align To Top] Button

Aligns all selected controls with the top edge of the uppermost selected control.

[Align To Bottom] Button

Aligns all selected controls with the bottom edge of the lowermost selected control.

[Align Horizontally] Button

This button can be used only when three or more controls are selected.

It arranges the controls in a uniform horizontal line. Without changing the position of the leftmost and rightmost control, this button arranges the controls between them at uniform intervals. It puts the same amount of space between each control and its neighbor.

[Align Vertically] Button

This button can be used only when three or more controls are selected.

It arranges the controls in a uniform vertical line. Without changing the position of the uppermost and lowermost control, this button arranges the controls between them at uniform intervals. It puts the same amount of space between each control and its neighbor.

[Horizontal/Center Align] Button

Aligns the selected controls horizontally with the center position.

[Vertical/Center Align] Button

Aligns the selected controls vertically with the center position.

■ [Picture] Button

Places a graphic file.

■ [TEXT] Button

Places a text box.

■ [Box] Button

Places a square.

■ [Ellipse] Button

Places an ellipse.

■ [Frame] Button

Places a frame.

■ [Line] Button

Places a line.

■ [Scene Recall Button] Button

Places a Scene Recall button.

■ Grid Setting

When arranging controls, you can align them along the grid. This menu sets the spacing of the grid.

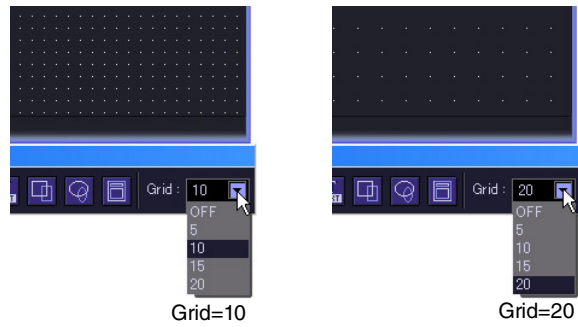

Clicking the [▼] button displays a menu. Click the menu to set the grid spacing. Select [OFF] to turn OFF the grid.

NOTE

When the grid is turned ON (when any grid item besides OFF is selected), clicking any control that is not aligned with the grid position, will cause it to align with the nearest grid. Please note that after copying multiple controls in one operation from the component editor and adjusting their positions manually, their positions could become disarranged when you select them by clicking on them, if they do not already align with the grid interval. Furthermore, if you change the grid spacing after aligning the positions of controls in the user control editor/user module editor, the controls will be placed into positions that do not align with the grid even if they are arranged using the align buttons. When there are controls that do not align with the grid, turn the grid OFF.

Changing the Window Size

In design mode, you can change the window size of the user control editor. If you align the mouse pointer with a side or corner of the window, its shape will change into a double-headed arrow. When the arrow is shaped like this, dragging it will change the size of the window.



Even if you change the width of the window, the library button will remain where it is, in the upper right corner.

Window Size and Background Settings

The size and background of the User Control Editor/User Module Editor window can be changed as required. A color or image file can be specified as the window background. These settings are made in the “User Control Editor Settings” dialog box. To display this dialog box, right-click in the user control editor window while in design mode, then click “User Control Editor Settings” on the displayed context menu.

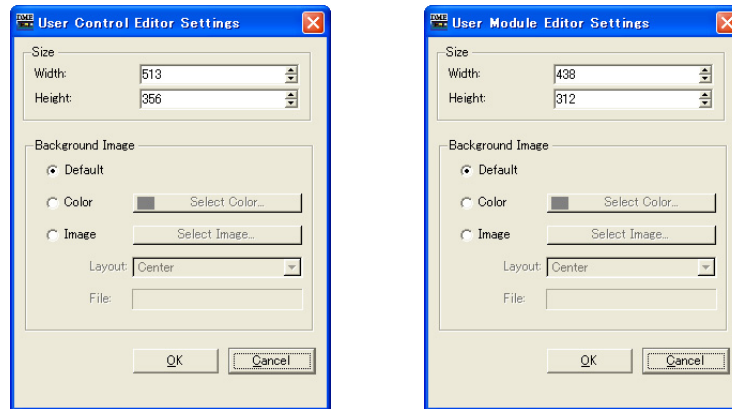

Size

■ [Width]

Sets the width of the User Control Editor/User Module Editor window in pixels, up to a maximum of 2,500 pixels.

■ [Height]

Sets the height of the User Control Editor/User Module Editor window in pixels, up to a maximum of 2,500 pixels.

Background Image

■ [Default]

Sets the background color to black, the same as the component editor. Select this if you have set the background with [Color] or [Image], and you want to return to the original background.

■ [Color]

Sets the color of the background. Use the [Select Color] button to select a color.

[Select Color] Button

Clicking here displays the “Select color” dialog box. This sets the color of the background. For information about the “Select color” dialog box, see [page 265](#).

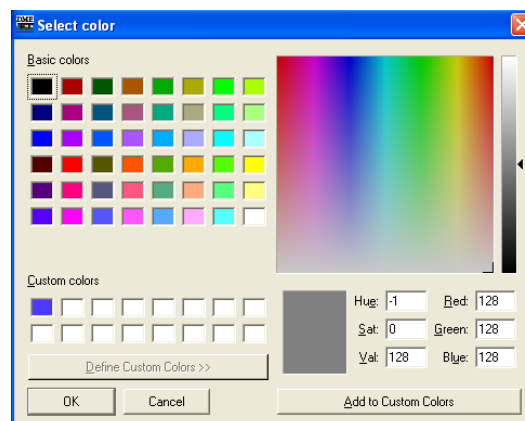

NOTE

If you select a light color, it may be difficult to see the grid.

■ [Image]

Displays an image for the background. You can use image files in the following formats: BMP (.bmp), PNG (.png), XPM (.xpm), and JPEG (.jpg). Use the [Select Image] button to select an image file.

[Select Image] Button

Clicking here displays the “Select Image” dialog box. Here you can select an image file to be displayed as the window background.

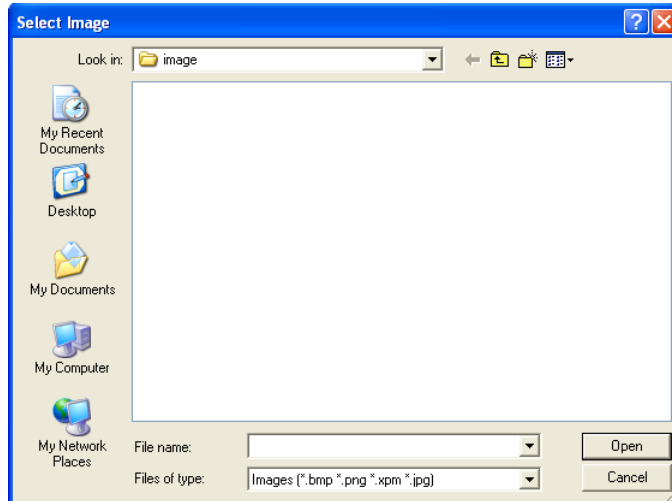

[Layout] Box

This box displays a list where you can select how the image file will be displayed.

- **[Center]**
Centers the image in the window.
- **[Tile]**
Displays multiple copies of the image side-by-side until the available space is filled. If the image file is smaller than the window, it will be displayed repeatedly like tiles on a wall.
- **[Fit]**
Expands or reduces the size of the image to match the size of the window where it will be displayed.

[File] Box

Displays a path for the image file.

Click the [Select Image] button and select an image file. The path will be automatically entered.

Placing Controls

Controls can be placed when you are in the design mode. You can turn the design mode ON and OFF by right-clicking in the user control editor/user module editor, or component editor, then clicking the [Design Mode] command in the context menu that is displayed.

You can place controls by dragging them from the component editor or by using the copy and paste commands.

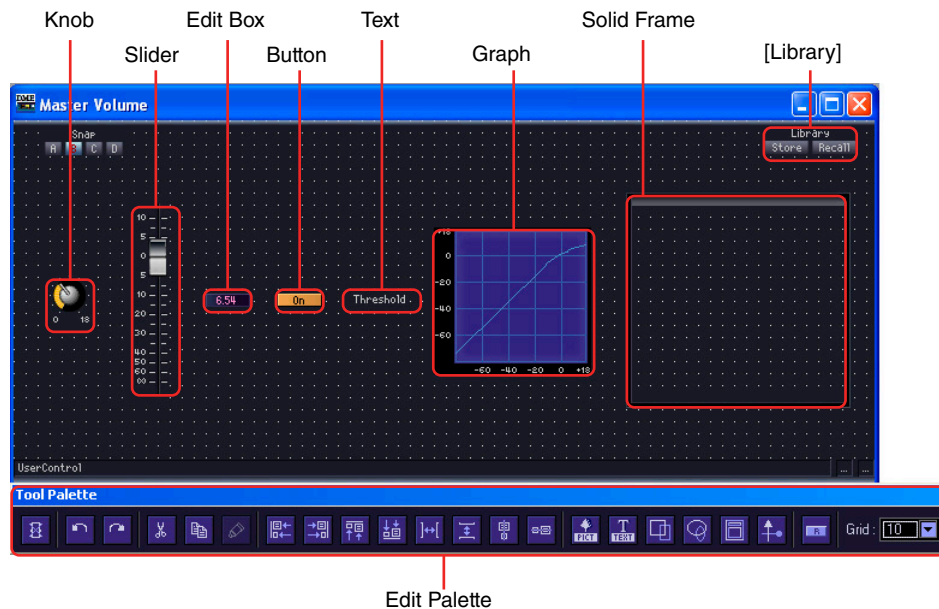

Selecting Controls

If you click a control in the component editor while in design mode, the control will be selected and a red frame will be displayed around it. Controls like knobs, sliders, edit boxes, and labels are all separate objects. Only the item clicked will be selected.

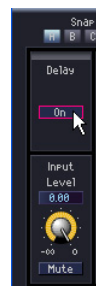

If you hold down the <Ctrl> key while clicking, you can select multiple controls and labels. If you use <Ctrl> + click on a selected control, it will cancel that control's selection.

If you position the mouse in an empty location on the sheet and start dragging from there, a frame will be displayed as the pointer moves. All controls enclosed by that frame will be selected.

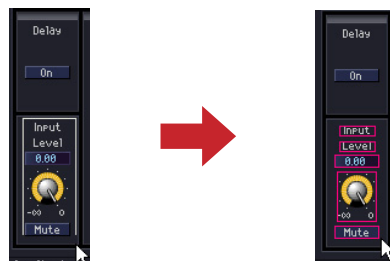

NOTE

If you drag controls like knobs and sliders, edit boxes and labels that show parameter types, and place them one-by-one in the user control editor, they must be arranged in the user control editor. If you select multiple items and drag them, you can copy them as a group into the user control editor, keeping their original arrangement.

When copying multiple controls from a single component editor, if you select all the controls you want copy and drag them together as a unit, their original positional relationship and tab order will be maintained.

■ Placing Controls by Dragging Them (User Control Editor)

You can drag the controls you want to copy from the component editor to the user control editor.

- 1** Open the component edit window that has the controls you will be placing in the user control box.
- 2** Open the user control editor.
User control names are displayed in the [View] → [User Control] submenu in the Main Panel window. Click a user control name to open its window.
- 3** Right-click in the component editor or the user control editor.
The context menu will be displayed.
- 4** Click [Design Mode] on the menu.

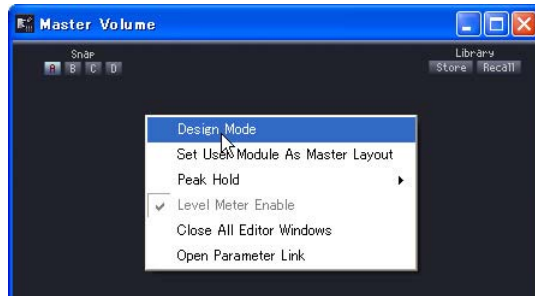

Design mode will be turned ON.

- 5** Drag the controls from the component editor to the user control editor.

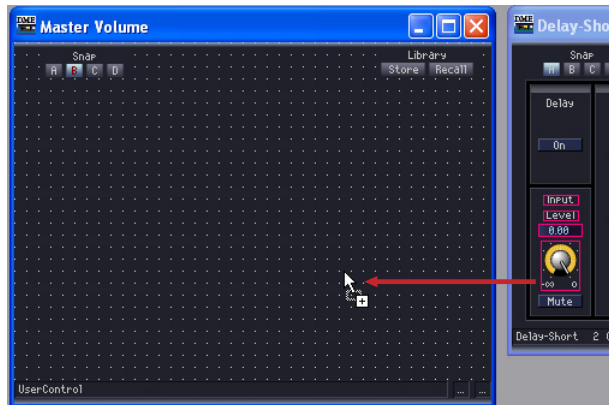

Arrange the controls in the user control editor.

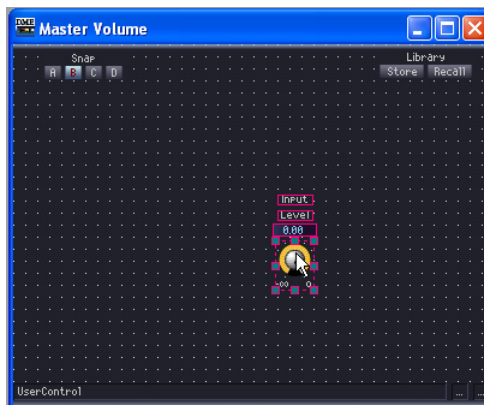

■ Placing Controls by Dragging Them (User Module Editor)

You can drag the controls you want to copy from the component editor window in the user module to the user module editor.

- 1 Create a user module, then arrange and connect the components for it.
- 2 Double-click the components and leave the component editor windows that appear open.
- 3 Store the user module by checking [Double Click Action] → [Open User Module Editor] in the Store dialog box (see “Saving User Modules” on [page 309](#) for details about storing user modules).

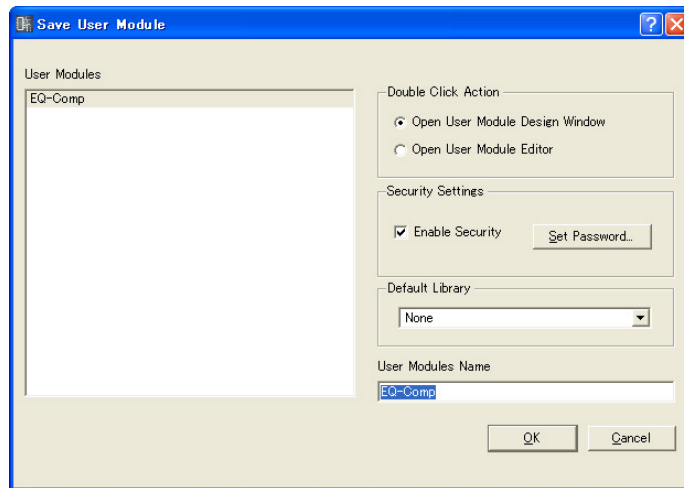

- 4 Double-click a user module in the Configuration window.
The user module editor will be displayed.
- 5 Right-click in the component editor or user module editor, then click the [Design Mode] command in the context menu.
Design mode will be turned ON.
- 6 Drag the controls from the component editor to the user module editor.
Arrange the controls in the user control editor.

■ Placing Controls Using Copy and Paste

Copy the controls in the component editor and paste in the user control editor or user module editor.

To copy controls in the component editor, press the [Copy] command shortcut keys, <Ctrl> + <C>.

To paste in the user control editor or user module editor, press the [Paste] command shortcut key, <Ctrl> + <V>, or the [Paste] button on the edit palette.

- 1 Click on the source component editor window to make it active, then select the control or controls you want to copy.



- 2 Press the <C> key while holding down the <Ctrl> key.

The selected controls will be copied to the clipboard.

- 3 With the target user control editor or user module editor active, press the <V> key while holding down the <Ctrl> key.

You can also paste by clicking the [Paste] button on the edit palette.

The controls will be copied.



■ When You Cannot Copy

Regardless of whether you drag or use copy and paste, you cannot create multiple copies from the same single component. If you drag controls that are already copied into the user control editor or user module editor, the mouse pointer will change into the “unavailable” mark (a circle with a diagonal slash), indicating that you cannot copy.

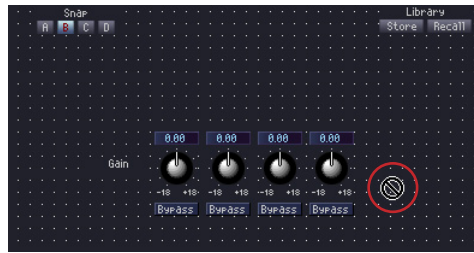

You can copy more than one component of the same type into the user control editor, as long as they come from different components located in the configuration or user module.

Controls for components arranged in the configuration can be copied only to the user control editor.

Controls for components arranged in a user module can be copied to both the user control editor and the user module.

■ Order of Controls

Controls newly pasted in the user control editor will be displayed above any previously pasted controls they overlap. The tab order for edit boxes will be the order in which they were pasted.

NOTE

In the component editor, you can select multiple controls using <Ctrl> + click or by dragging. Once controls are copied, they will be pasted in the order in which they were copied.

Moving and Aligning Controls

In the user control editor or user module editor, you can move or align copied controls.

■ Selecting Controls

In the user control editor or user module editor, controls are selected in the same way as in the component editor. Click a control to select it, or press <Ctrl> + click to select multiple controls. If you use <Ctrl> + click on a selected control, it will cancel that control's selection. If you position the mouse in an empty location in the user control editor or user module editor and start dragging from there, a frame will be displayed as the pointer moves. All controls enclosed by that frame will be selected.

A red frame will be drawn around the selected controls.

■ Moving Controls

Move selected controls by dragging them or by pressing the arrow keys on your keyboard. When you select multiple controls using <Shift> + click, you can move all of them at the same time.

Dragging

When grid is ON, the upper left of the dragged controls will automatically align with the grid. When dragging, the coordinates displayed here refer to the upper left corner of the object being dragged. The “Distance to Right” and “Distance to Bottom” are displayed in pixel units, using the upper-left of the window as a reference point.



When multiple controls are selected and dragged, the coordinates are those of the upper-left corner of the control where the mouse is aligned.

Arrow Keys

When the grid is ON, the arrow keys move controls a grid unit at a time. When the grid is OFF, controls are moved one pixel at a time.

■ Alignment

You can align controls using the following alignment buttons on the edit palette: [Align Left], [Align Right], [Align To Top], [Align To Bottom], [Align Horizontally], [Align Vertically], [Horizontal/Center Align], and [Vertical/Center Align].

You can only use the [Align Horizontally] or [Align Vertically] buttons when three or more controls are selected.

Cut/Copy/Paste Controls

You can edit controls arranged in the user control editor or user module editor using the [Cut], [Copy], and [Paste] commands in the edit palette.

■ Cut

Cuts controls arranged in the user control editor. Select one or more controls, then press the [Cut] button on the edit palette.

■ Copy

Copies controls arranged in the user control editor or user module editor. Select one or more controls, then press the [Copy] button on the edit palette.

■ Paste

Pastes cut or copied controls. Click the [Paste] button on the edit palette. If you cannot paste, the button color turns pale.

■ Delete

Controls can be deleted by selecting them and pressing the <Delete> key.

Knob/Slider Conversion

This function makes it possible to convert knobs placed in the user control editor or user module editor to sliders, or vice-versa.

Right-click on a knob or slider and select [Convert] → [Slider] or [Convert] → [Knob], as appropriate. The [Convert] item will not appear for certain special knobs and sliders that cannot be converted.

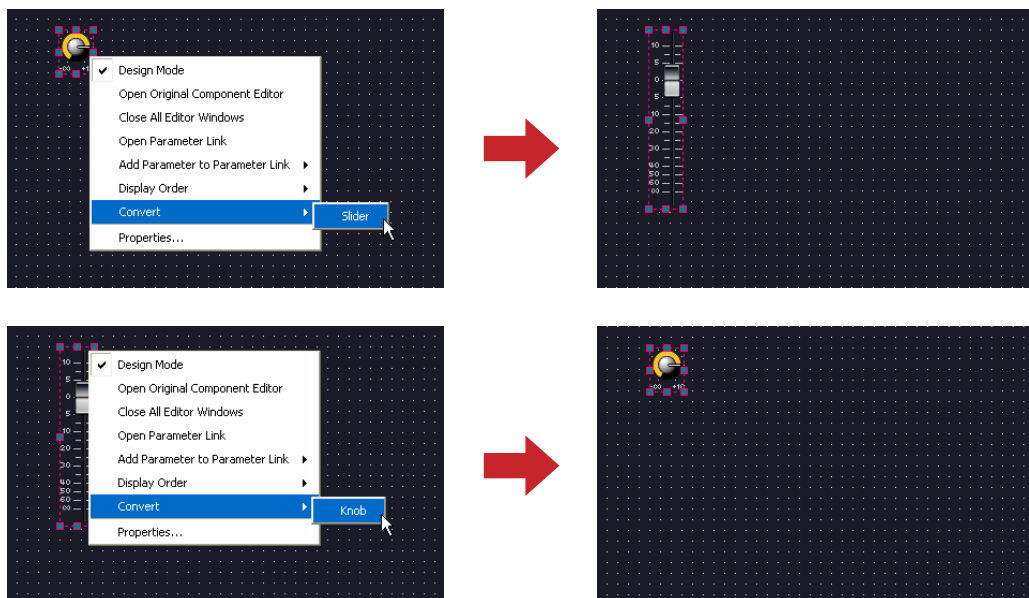

Undo and Redo Commands During Editing

The [Undo] and [Redo] commands in the main panel window [Edit] menu, and the [Undo] and [Redo] commands in the editing palette, can be used to undo or redo controller move, size change, or delete operations.

NOTE

If you close an editor window, you will no longer be able to undo and redo operations performed there.

Control Properties

A properties dialog box will open when you either double click a controller in the User Control Editor or User Module Editor, or right-click the controller and select [Properties] from the contextual menu. Here you can specify a design for the controller.

Multiple properties of the same type can be set at the same time by clicking the controllers while holding the <Ctrl> key and then opening the properties dialog box.

Edited items are shown in bold text until you either click [OK] or [Cancel].

■ “Knob Properties” Dialog Box

When you right-click on a knob, then select [Properties] from the context menu, the “Knob Properties” dialog box will be displayed. This dialog box sets the size of the knob.

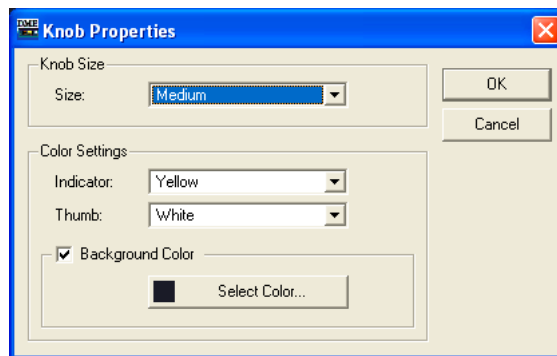

[Size]

Displays a list where you can select the knob size. Select [Large], [Medium], [Small], or [Very Small].

NOTE

You can change the size of a knob by dragging one of the marks at the four corners (top, bottom, left, right) of the knob in the user control editor.

Color Settings

- **[Indicator]**
Select an indicator color from the list: [White]/[Red]/[Yellow]/[Green]/[Blue]/[Violet]/[Black]/[Light Blue]
- **[Thumb]**
Select a knob color from the list: [Black]/[Gray]/[White]/[Red]/[Yellow]/[Green]/[Blue]/[Violet]
- **[Background Color]**
Uncheck this item to make the background transparent. When this item is checked the [Color] button to its right opens the “Select color” dialog box that can be used to select a background color.

■ “Slider Properties” Dialog Box

The “Slider Properties” dialog box will appear when you either double-click a slider or right-click it and select [Properties] from the contextual menu. This lets you change the size, orientation, and other characteristics of the related slider.

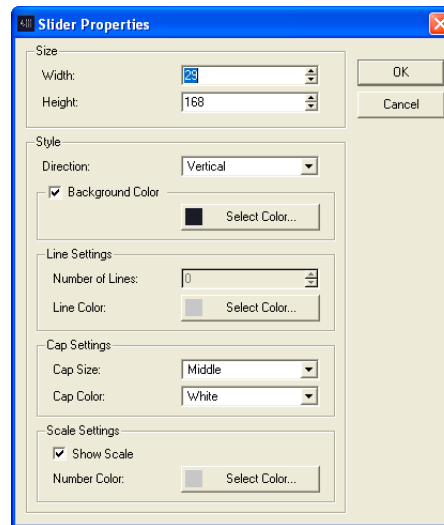

Size

[Width] and [Height] set the width and height of the slider in pixel increments.

NOTE

The size of sliders can also be changed by dragging any of the slider’s corners in the user control editor.

[Direction]

Set the slider’s orientation to [Vertical] or [Horizontal] as required.

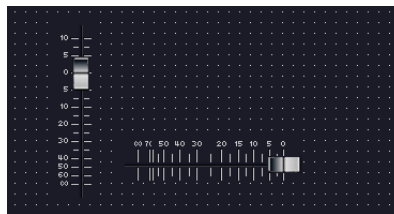

[Background Color]

Uncheck this item to make the background transparent. When this item is checked the [Color] button to its right opens the “Select color” dialog box that can be used to select a background color.

[Number of Lines]

Sets the number of scale markings (lines) between the minimum and maximum values.

Line Color

Click the [Select Color] button and select the desired scale line color in the “Select Color” dialog box.

[Cap Size]

Select a knob cap size from the list: [Very Large]/[Large]/[Middle]/[Small]/[Very Small].

[Cap Color]

Select a knob cap color from the list: [Black]/[Gray]/[White]/[Red]/[Yellow]/[Green]/[Blue]/[Violet]

[Show Scale]

Check this item to show the numeric scale values.

Number Color

Click the [Select Color] button and select the desired scale number color in the “Select Color” dialog box.

■ “Toggle Button Properties” Dialog Box

The Toggle Button Properties dialog box will appear when you either double click the ON/OFF button or right-click it and select [Properties] from the contextual menu. This sets the text displayed by the button, along with the color of the button.

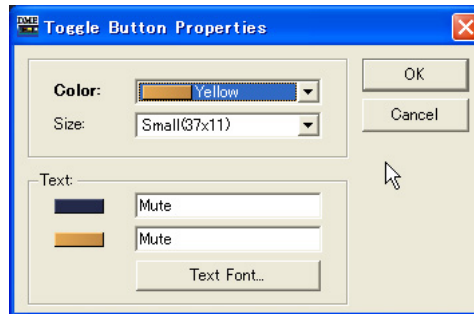

[Color]

Displays a list where you can select the color of the button. If you click the [▼], a list of button colors will be displayed.

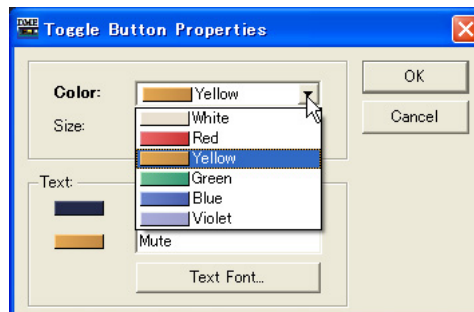

[Size]

Select a button size from the list: [Small (37x11)], [Small (51x11)], [Medium (74x11)], [Medium (74x22)], or [Large (111x33)].

[Text] box

Enter the text to be displayed by the button. You can set different text for when the button is ON and for when it is OFF.

[Text Font] Button

Sets the font, size and style. Clicking here displays the “Select Font” dialog box. For information about the “Select Font” dialog box, see [page 264](#).

■ “Radio Button Properties” Dialog Box

The Radio Button Properties dialog box will appear when you either double click a radio button or right-click it and select [Properties] from the contextual menu. You can set the button's color, size, and font.

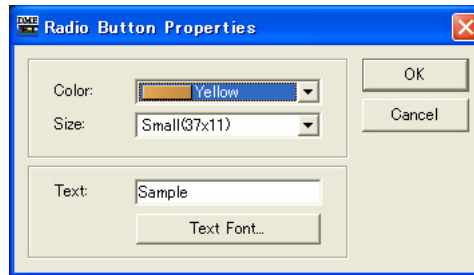

[Color]

Select a color from the list: [White], [Red], [Yellow], [Green], [Blue], or [Violet].

[Size]

Select a button size from the list: [Small (37x11)], [Small (44x11)], [Medium (75x11)], [Medium (74x22)], or [Large (111x33)].

[Text] Box

Enter the text to be displayed by the button.

[Text Font] Button

Sets the font, size and style. Clicking here displays the “Select Font” dialog box. For information about the “Select Font” dialog box, see [page 264](#).

■ “Edit Box Properties” Dialog Box

The Edit Box Properties dialog box will appear when you either double click an edit box or right-click it and select [Properties] from the contextual menu. Here you can set the edit box size.

[Size]

Select an edit box size from the list: [Large], [Medium], or [Small].

■ “Level Meter Properties” Dialog Box

The Level Meter Properties dialog box will appear when you either double click a level meter or right-click it and select [Properties] from the contextual menu. Here you can specify the number of meter segments and scale.

Size

The width is set using the [Width] and the height is set using [Height]. The units are pixels.

[Segment]

Select a number of meter segments from the list: [2], [6], or [60].

[Scale]

Select the type of scale to be displayed beside the meter from the list. This option is only available when [Segment] is set to 60.

■ Slider “Level Meter Properties” Dialog Box

The “Level Meter Properties” dialog box will appear when you either double-click a slider level meter or right-click it and select [Properties] from the contextual menu. This lets you change the size and orientation of the related level meter.

Size

[Width] and [Height] set the width and height of the level meter in pixel increments.

NOTE

The size of level meters can also be changed by dragging any of the meter's corners in the user control editor.

[Direction]

Set the level meter's orientation to [Vertical] or [Horizontal] as required.

■ “Indicator Properties” Dialog Box

The “Indicator Properties” dialog box will appear when you either double-click an indicator or right-click it and select [Properties] from the contextual menu. This lets you change the size and display characteristics of the related indicator.

Size

[Width] and [Height] set the width and height of the indicator in pixel increments.

NOTE

The size of indicators can also be changed by dragging any of the indicator's corners in the user control editor.

[Threshold Logic]

Determines whether the indicator will light or go out when the monitored parameter exceeds the threshold. Select [Turn On] if you want the indicator to light when the threshold is exceeded, or [Turn Off] if you want the indicator to go out when the threshold is exceeded.

[Color]

Click the [Select Color] button and select the desired indicator color in the “Select Color” dialog box.

■ “Solid Frame Properties” Dialog Box

The Solid Frame Properties dialog box will appear when you right-click a solid frame and select [Properties] from the contextual menu. Here you can enter the text to be displayed. Here you can set the frame size and divider location.

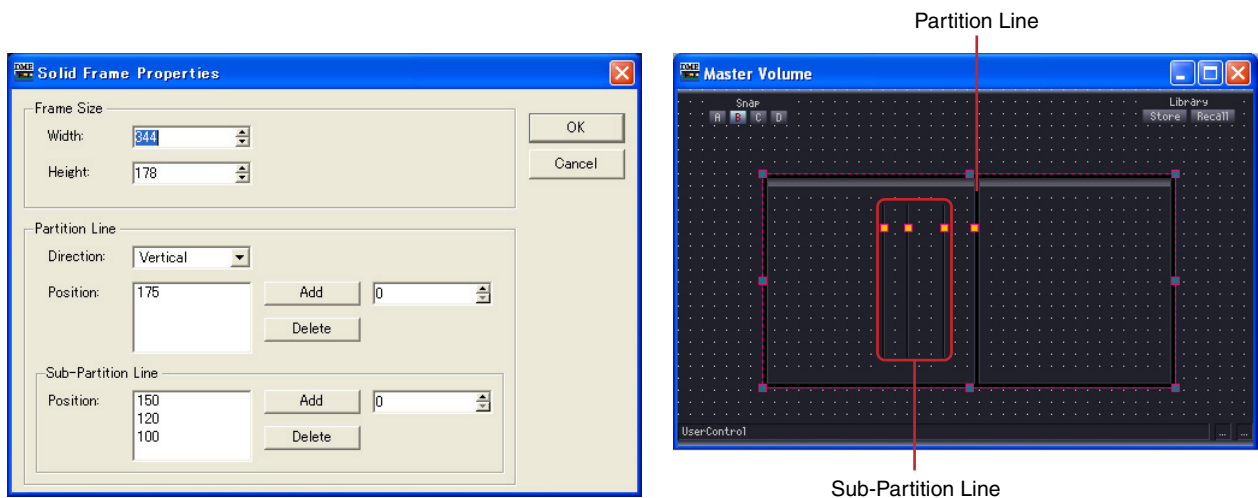

Frame Size

The width is set using the [Width] and the height is set using [Height]. The units are pixels.

NOTE

You can change the size of a frame by dragging one of the marks at the four corners (top, bottom, left, right) of the frame in the user control editor.

Partition Line/Sub-Partition Line

Sets partition lines within the frame. [Partition Line] is a long partition line displayed from end to end, and [Sub-Partition Line] is a short partition line.

- **[Direction]**
Select the direction of a partition line from the list. [Vertical] inserts a vertical partition line and [Horizontal] inserts a horizontal partition line. When [None] is select, partition lines are not displayed.
- **[Position]**
Displays the currently set line position. Displays the number of pixels from the top of the solid frame when [Vertical] is selected for the [Direction], and the number of pixels from the left of the solid frame when [Horizontal] is selected.

NOTE

You can change the position of a partition line by dragging one of the marks on the line in the user control editor.

- **[Add] Button**
If you set the position of the partition line in the box on the right and click the [Add] button, the partition line will be added and displayed in the [Position] list.
- **[Delete] Button**
Deletes the partition line selected in the [Position] list.

■ “Color Frame Properties” Dialog Box

The Color Frame Properties dialog box will appear when you right-click a solid frame and select [Properties] from the contextual menu. Here you can enter the text to be displayed. Here you can set the frame size and divider location.

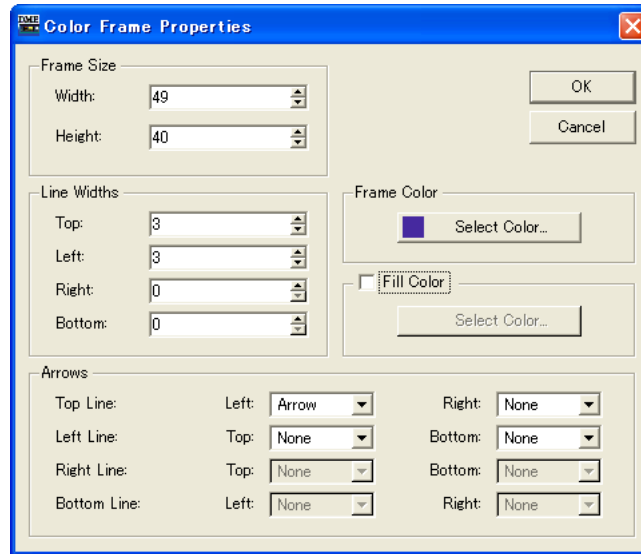

Frame Size

The width is set using the [Width] and the height is set using [Height]. The units are pixels and the minimum value is 3.

NOTE

You can change the size of a frame by dragging one of the marks at the four corners (top, bottom, left, right) of the frame in the user control editor.

Line Width

Sets the thickness of the lines at [Top]/[Left]/[Right]/[Bottom]. Set “0” to display no lines.

Frame Color

Sets the color of the color frame.

Click this button to display the “Select color” dialog box. For information about the “Select color” dialog box, see [page 265](#).

Fill Color

Sets the frame fill color.

Click the [Select Color] button to display the “Select color” dialog box. Refer to “Select Color” Dialog Box in the Object section on [page 265](#) for information on this dialog box.

Arrows

Specifies the shape of line endpoints (terminals).

The [Left] and [Right] endpoints of [Top Line] and [Bottom Line] lines, and the [Top] and [Bottom] endpoints of [Left Line] and [Right Line] lines, can be set independently.

None: No endpoint shape.

Arrow: Arrow-shaped endpoint.

Circle: Circle-shaped endpoint.

■ User Picture Properties Dialog Box

Right-click the image and select [Properties] from the contextual menu to display the User Picture Properties dialog box.

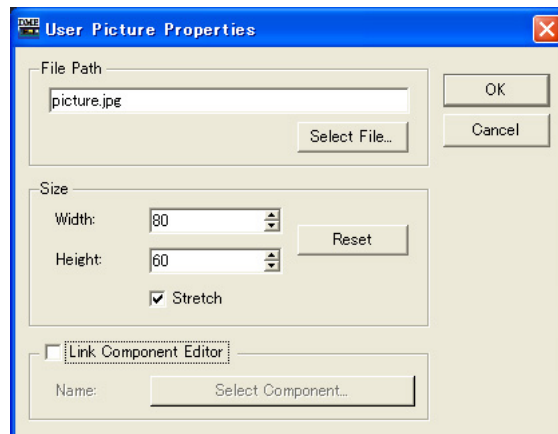

[File Path] Box

Displays the path to the graphic file.

[Select File] Button

Selects a graphic file.

Size

- **[Width]**
Specifies the width in pixels.
- **[Height]**
Specifies the height in pixels.
- **[Reset] Button**
Click to display the graphic at it's original size.
- **[Stretch]**
When ON, the graphic will be enlarged when a size that is bigger than it's original size is specified.

[Link Component Editor]

When ON, clicking the [Select Component] button selects the editor that is opened when the graphic is clicked.

■ Text Properties Dialog Box

Right-click the text box and select [Properties] from the contextual menu to display the Text Properties dialog box.

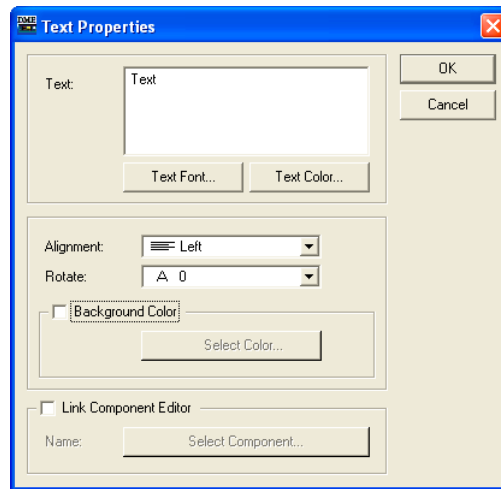

[Text] Box

Displays and edits the text to be displayed.

[Text Font]

Selects the font. Click to display the Select Font dialog box.

Refer to “Select Font” Dialog Box on [page 264](#) for more information on the Select Font dialog box.

[Text Color] Button

Sets the text color. Click to display the Select Color dialog box. For information about the “Select color” dialog box, see [page 265](#)

[Alignment]

Selects [Left], [Center], or [Right] text alignment.

[Rotate]

Rotates the text box.

[Background Color]

Uncheck this item to make the background of text transparent. When this item is checked the [Color] button below the checkbox opens the “Select color” dialog box that can be used to select a background color.

[Link Component Editor]

When ON, clicking the [Select Component] button selects the editor that is opened when the text box is clicked.

■ Box Properties Dialog Box

Right-click the box and select [Properties] from the contextual menu to display the Box Properties dialog box.

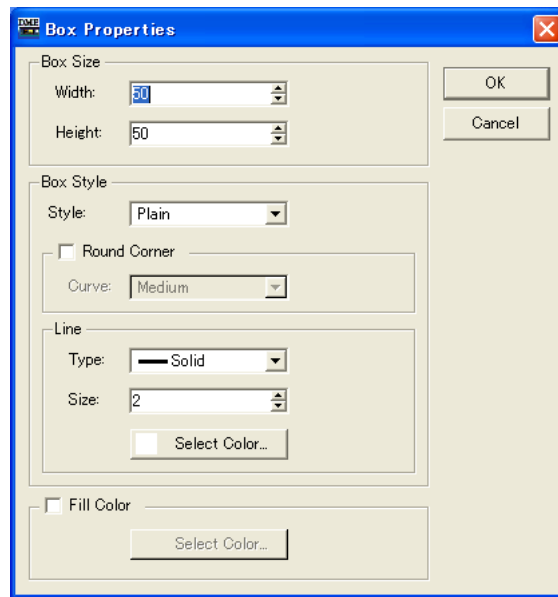

Box Size

- **[Width]**
Specifies the width in pixels.
- **[Height]**
Specifies the height in pixels.

Box Style

- **[Style]**
Sets the style of the object. Select [Plain], [Raised], or [Sunken] from the list.
- **[Round Corner]**
Turn ON to produce a round-cornered box. Use [Curve] to select the degree of roundness.

Line

- **[Type]**
Select a type of frame line from the list: [Solid], [Dash], [Dot], [Dash Dot], or [Dash Dot Dot].
- **[Size]**
Sets the thickness of the frame line in pixels. The range is from 1 to 100.
- **[Select Color] Button**
Sets the color of the frame line. Click to display the “Select color” dialog box.
Refer to “Select Color” Dialog Box on [page 265](#) for more information on the Select Color dialog box.

Fill Color

- **[Select Color] Button**
Sets the frame fill color. Click to display the “Select color” dialog box.
Refer to “Select Color” Dialog Box on [page 265](#) for more information on the Select Color dialog box.

■ Ellipse Properties Dialog Box

Right-click the ellipse and select [Properties] from the contextual menu to display the Ellipse Properties dialog box.

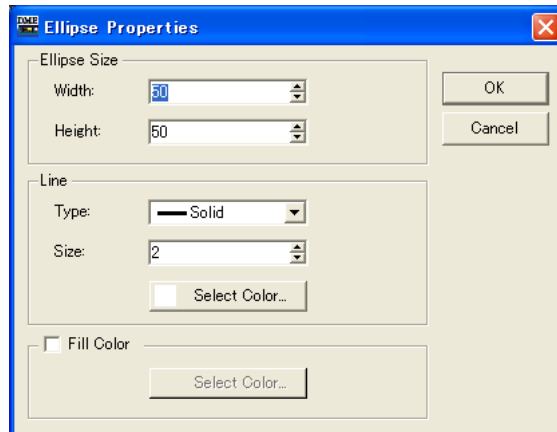

Ellipse Size

- **[Width]**
Specifies the width in pixels.
- **[Height]**
Specifies the height in pixels.

Line

- **[Type]**
Select a type of frame line from the list: [Solid], [Dash], [Dot], [Dash Dot]. Or [Dash Dot Dot].
- **[Size]**
Sets the thickness of the frame line in pixels. The range is from 1 to 100.
- **[Select Color] Button**
Sets the color of the frame line. Click to display the “Select color” dialog box. Refer to “Select Color” Dialog Box on [page 265](#) for more information on the Select color dialog box.

Fill Color

Sets the ellipse fill color when ON.

- **[Select Color] Button**
Sets the ellipse fill color. Click to display the “Select color” dialog box. Refer to “Select Color” Dialog Box on [page 265](#) for more information on the Select color dialog box.

■ “Line Properties” Dialog Box

Double-click a line or right-click it and select [Properties] from the contextual menu to display the “Line Properties” dialog box. This lets you change the size and style of the related line.

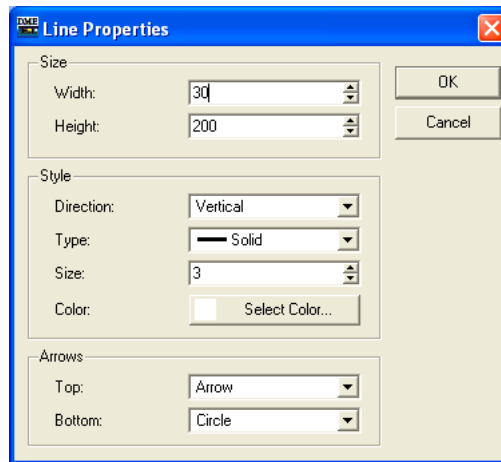

Size

[Width] and [Height] set the width and height of the line in pixel increments.

NOTE

The size of lines can also be changed by dragging any of the line's corners in the user control editor.

[Direction]

Set the line's orientation to [Vertical] or [Horizontal] as required.

[Type]

Select a line type from the list: [Solid]/[Dash]/[Dash Dot]/[Dash Dot Dot].

[Size]

Sets the line width.

[Color]

Click the [Select Color] button and select the desired line color in the “Select Color” dialog box.

[Top/Left]

Select a line termination for the top or left end of the line from the list: [None]/[Arrow]/[Circle].

[Bottom/Right]

Select a line termination for the bottom or right end of the line from the list: [None]/[Arrow]/[Circle].

■ “Scene Recall Button Properties” Dialog Box

Double-click a Scene Recall button or right-click it and select [Properties] from the contextual menu to display the “Scene Recall Properties” dialog box. This lets you specify the scene to be recalled by the button, and other characteristics.

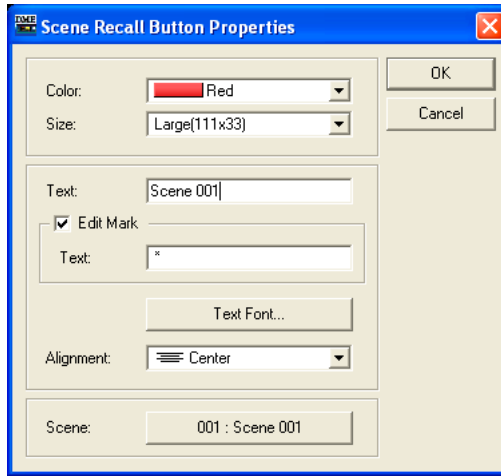

[Cap Color]

Select a button color from the list: [White]/[Red]/[Yellow]/[Green]/[Blue]/[Violet].

[Size]

Select a button size from the list] [Small (37x119)]/[Small (44x11)]/[Middle (75x11)]/[Middle (74x22)]/[Large (111x33)]/[Large (222x66)].

[Text]

Enter the text to be displayed in the button.

[Edit Mark]

When this item is checked the specified text will be displayed when the assigned scene has been edited. The additional text is entered via the [Text] box below.

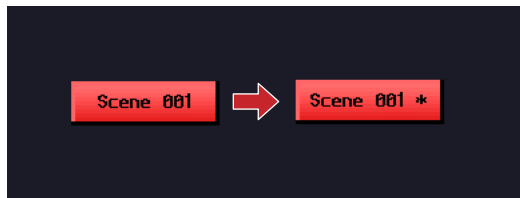

[Text Font] Button

The “Select Font” dialog box will appear when this button is clicked. Select the required font, style, and size. Refer to “Select Font Dialog Box” in the “Objects” section on [page 264](#) for more information about the “Select Font” dialog box.

[Alignment]

Select [Left], [Center], or [Right] alignment.

[Scene]

Specifies the scene that will be selected when the button is clicked. Click the [Select Scene] button to open the scene selection menu.

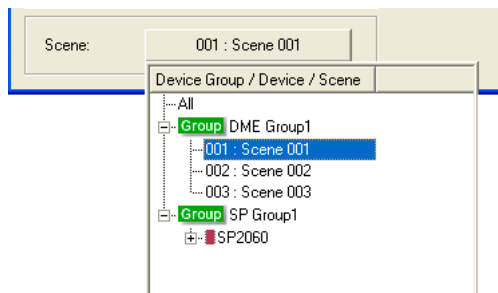

Changing the Tab Order

The tab order for edit boxes is determined by the order in which they were pasted into the user control editor or user module editor. If you right-click the user control editor or user module editor, you can check or change the tab order using the [Tab Order] command on the context menu.

If you select the [Tab Order] command, tab order numbers will be displayed at the upper-left of each edit box. Clicking the displayed numbers changes the order.

NOTE

The tab order for other controls such as knobs, sliders, and buttons cannot be set.

1 Right-click in the user control editor or user module editor.

The context menu will be displayed.

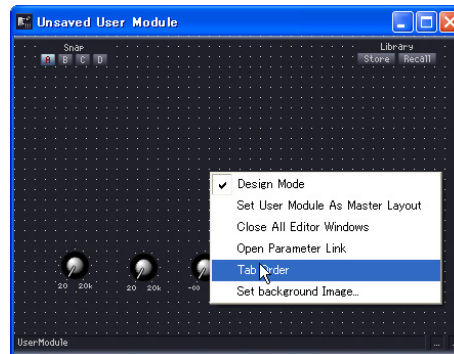

2 Click [Tab Order] in the context menu.

Numbers for the current tab order are displayed to the upper-left of each edit box.

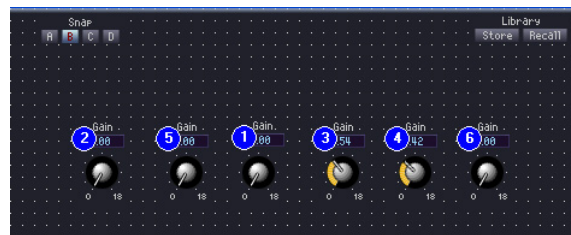

3 Click the tab order numbers in the order in which you want to set the tab order.

Even if you do not want to change tab order number 1, click all the numbers in the order you desire, starting from number 1. When you click on each number, it will change to the number that reflects the order in which it was clicked.

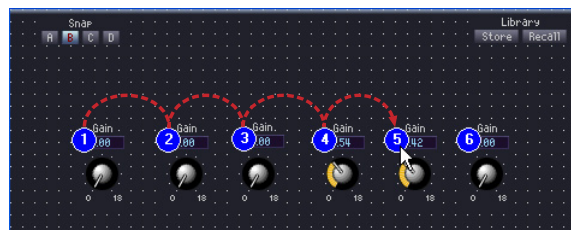

4 Once you have finished specifying the order, click somewhere within the window where there is no tab number.

The tab order numbers will disappear.

The changed tab order will apply the next time user control editor or user module editor is started.

Operation Mode and Design Mode

There are two modes for the user control editor/user module editor and the component editor: “**operation mode**” and “**design mode**.” In operation mode you adjust parameters, while in design mode you lay out controls.

You can switch between operation mode and design mode using the context menu that is displayed when you right-click in the user control editor/user module editor or component editor.

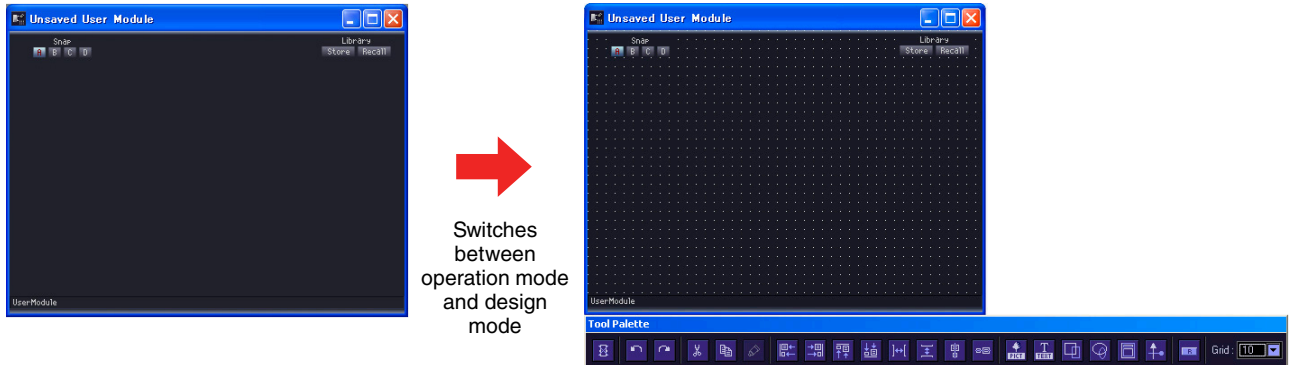

The [Design Mode] command switches the design mode between ON and OFF. A checkmark appears when the design mode is turned ON. If you click in the context menu when the checkmark is present, design mode will turn OFF, and the edit window will return to operation mode.

NOTE

Only users for whom the [Operation Security] → [Edit] checkbox in the “Security” dialog box has been checked can turn the design mode ON.

NOTE

You can select controls in the component editor so that you can copy them into the user control editor/user module editor. When you want to select multiple objects, hold down the <Ctrl> key as you click each new object you want to select.

Context Menu

The context menus that appear when you right-click in a window will differ in operation mode and in design mode. In design mode, other commands will be added, depending on where you click.

■ Operation Mode Context Menu

Some commands that are displayed in the context menus for operation mode will also be displayed in design mode.

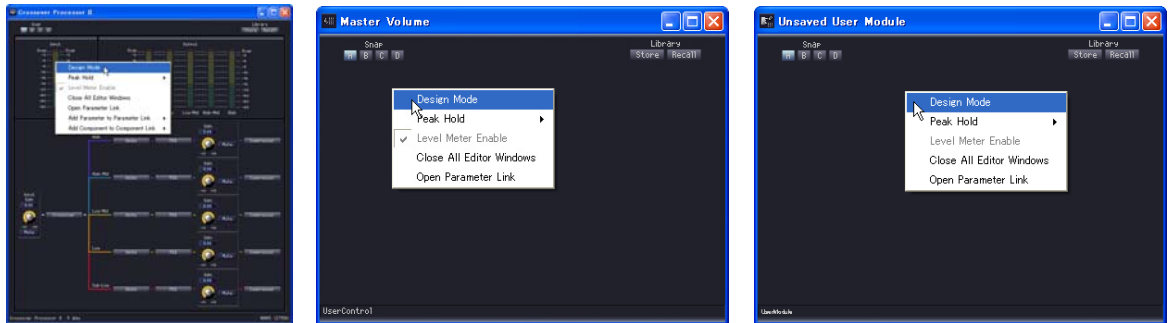

[Design Mode]

Switches between design mode and operation mode. When you are in design mode, a checkmark will appear to the left of the command name.

[Peak Hold]

Turns the peak hold meter ON or OFF and performs a reset. The ON or OFF setting for peak hold applies to the whole zone.

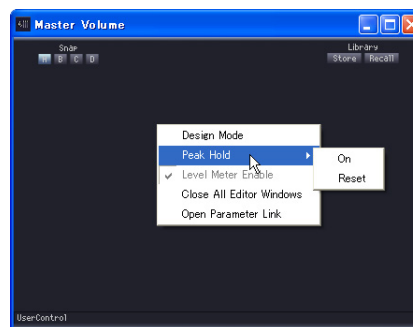

- [On]
When you select this, peak hold is turned ON, and a checkmark appears next to it. If you select this item while it is checked, peak hold is turned OFF.
- [Reset]
Resets peak hold.

NOTE

Peak hold is a function that makes it easy to see the maximum signal value by lighting up at the level of the maximum value as the signal peak comes in.

[Level Meter Enable]

Specifies whether the level meters will be enabled or disabled.

[Close All Editor Windows]

Closes all component editor windows.

[Open Parameter Link]

Opens the “Parameter Link” window. For information about the Parameter Link window, see “Parameter Link” (page 94).

[Add Parameter to Parameter Link]

Creates a parameter link. See “Creating Parameter Links” (page 368).

[Add Component to Component Link] (Component editor only)

Creates a component link. See “Creating Component Links” (page 370).

■ The Context Menu Displayed in Design Mode When You Right-Click an Empty Location

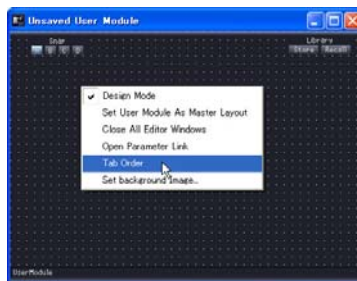
**[Tab Order] (User Control Editor and User Module Editor only)**

When using user control editors or user module editors, this function displays the order in which you move through them by pressing the <Tab> key. When you select this command, numbers are displayed next to the edit boxes. A checkmark appears next to [Tab Order] in the context menu. To exit tab order settings, click [Tab Order] the context menu or click anywhere besides a tab order number in the user control editor.

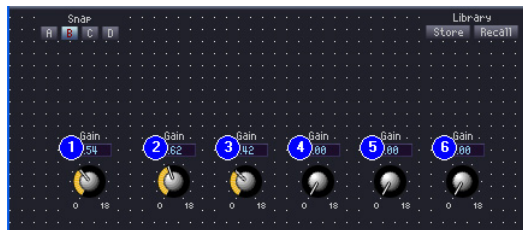

Clicking the displayed numbers changes the order. The numbers are changed in the order that they are clicked. To exit tab order settings, click [Tab Order] the context menu or click anywhere besides a tab order number in the user control editor.

→ See “Changing the Tab Order” on page 357.

[User Control Editor Settings] (User Control Editor and User Module Editor only)

Sets a background image for a window. Clicking here displays the “User Control Editor Settings” dialog box.

→ See “Window Size and Background Settings” on page 335.

■ The Context Menu Displayed in Design Mode When You Right-Click a Control

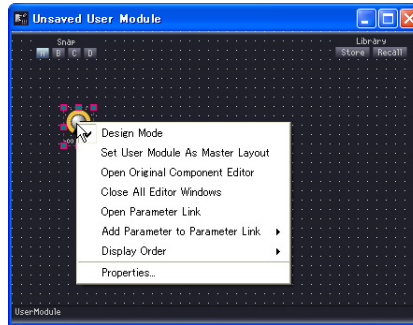

[Open Original Component Editor] (User Control Editor and User Module Editor only)

It opens the component editor for the control you clicked.

[Display Order]

Specifies the vertical display order of the controllers.

It opens the component editor for the control you clicked.

[Properties]

Opens the properties dialog box for the control.

→ See "Control Properties" on [page 344](#).

NOTE

There some controls, such as sliders, that do not display the [Properties] command.

■ The contextual menu that appears in when a controller is right-clicked in the design mode.

[Properties] (User Control Editor & User Module Editor only)

Opens the controller properties window. Refer to "Control Properties" on [page 344](#).

Snap

The Snap function records parameters for the component editor, user control editor, and user module editor temporarily. Clicking a button switches the parameter set, setting all parameters in the editor to the status that existed when the parameters were recorded in the memory. You can record the current values for parameters. Furthermore, when you recall a library, it is recorded to the Snap button that is on at that time. For more information about libraries, see “Library” (page 364).

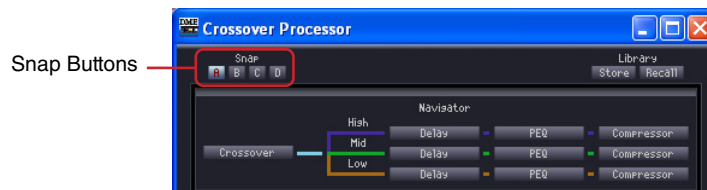

■ Snap Buttons ([A] through [D])

The Snap buttons allow you to switch between parameter sets. The buttons change in appearance according to their ON/OFF status and to whether or not there were changes to the parameter set from when the editor was started.

When there has been no change to the parameter set since the editor was started

When a button is selected it lights up.

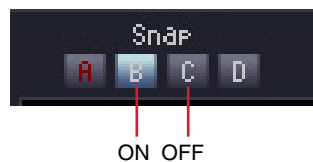

When a parameter set that is different than when the editor was started has been recorded to a button

The color of the button name changes on buttons for which the parameter set has changed. When a button is selected it lights up.



■ Recording Parameter Sets

Recording parameters from the current window

The parameters present when the snap button is switched are recorded to the snap button before the switch.

- 1** Click the snap button ([A] through [D]) that will record the parameter set. This turns it ON.
- 2** Set the parameters in the editor to the settings you want to record.
- 3** Click another snap button.

Recalling a Library

- 1 Click the snap button that has recorded the parameter set. This turns it ON.
- 2 The library is recalled.

■ Switching Parameter Set

If you click a snap button that has a parameter set recorded, the system switches to the parameter set recorded there.

■ Copying Parameter Sets

Parameter sets can be copied between snap buttons [A]~[D].

- Select from the contextual menu.
- Drag and drop.
Drag-and-drop copy will also work between components of the same type.

Library

Component editor, user control editor, and user module editor parameters can be saved as library files. By reading back a saved library file, you can reset all the editor parameters to the status they had when the file was saved. Saving in a library file is called “storing,” while bringing back the settings is called “recalling” them.

Library files have the following file name extensions: “.cel” for component editors, “.ucl” for user control editors, and “.uml” for user module editors.



If you store library files in the “Library\component group names\component names” folders in the [ContentsFolder] specified in the Main Panel window “Preferences” dialog box, they will be automatically displayed in the component editor [Recall Library] menu. The dialog box used for storing items in the library opens with the library folder displayed.

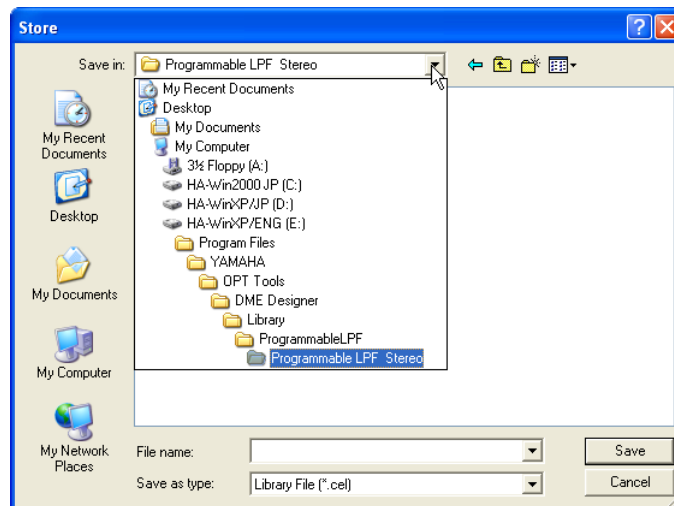

If you save like this without changing the folder, the item you saved will be displayed on the [Recall Library] menu. When a library is saved, it can be displayed in the component editor for other project files besides the currently open one, and also in new project files.

NOTE

In the “Save Library File” dialog box, you can specify another folder for saving library files, and save them there. Library files that are saved in another folder also can be recalled by specifying the folder.

■ Library Filenames

Because the library filenames are displayed in the [Recall Library] menu, use a filename that helps you understand the contents of the parameter set in the file. When saving in the default folder, there is no need to include the component name in the filename.

For example, when you are storing a parameter set in the stereo compressor library, the “Save Library File” dialog will be displayed with the “Library\Compressor\Compressor Stereo” folder in the [ContentsFolder] selected. If you save in that folder, the file you save will be displayed only in the [Recall Library] menu for stereo compressor components only. It will not be displayed in any other library.

If you use a filename that makes it easy to understand the parameter contents or the conditions under which they are used, you can select them without confusion when recalling.

Storing in the Library

The library is the place to store component editor parameters.

■ Editor Window

- 1** Set the parameters to be stored in the library.
- 2** Click the [Store Library] button in the component editor.
The “Save Library File” dialog box will be displayed.
- 3** Enter the filename.
Select a filename that makes it easy to understand the contents of the parameter set.
- 4** Specify the folder for saving the file.
If you want the saved file displayed on the [Recall Library] menu, do not change the folder for saving.
- 5** Click the [Save] button.

■ Designer Window

Right-click a component or user module in the Designer window to show the contextual menu. Use the [Store Component Library] command to store the library.

The menu that appears when the contextual menu [Store Component Library] command is clicked is the same as the menu that appears when the Edit window [Store Library] button is clicked.

Specify a file name and save the file.

Recalling a Library

The recall function reads stored parameters into the component editor.

■ Editor Windows

You can recall libraries in the component editor, user control editor, and user module editor windows by clicking the [Recall Library] button. When a library is recalled in an editor window, the parameter set is recorded to the selected snap button.

- 1 Click the snap button ([A] through [D]) that will record the parameter set.
- 2 Click the [Recall Library] button in the component editor.
The [Recall Library] menu will be displayed.
- 3 Click the library name (filename) in the [Recall Library] menu.
The parameters in the library will be recalled.

■ Designer Window

If you right-click on a component or user module in the design window, a context menu will be displayed. You can recall a library using the [Recall Component Library] command. If you click [Recall Component Library] in the context menu, the same menu is displayed as when you click the [Recall Library] button in the editor window. If you select a library that is displayed in the submenu, that library is recalled.

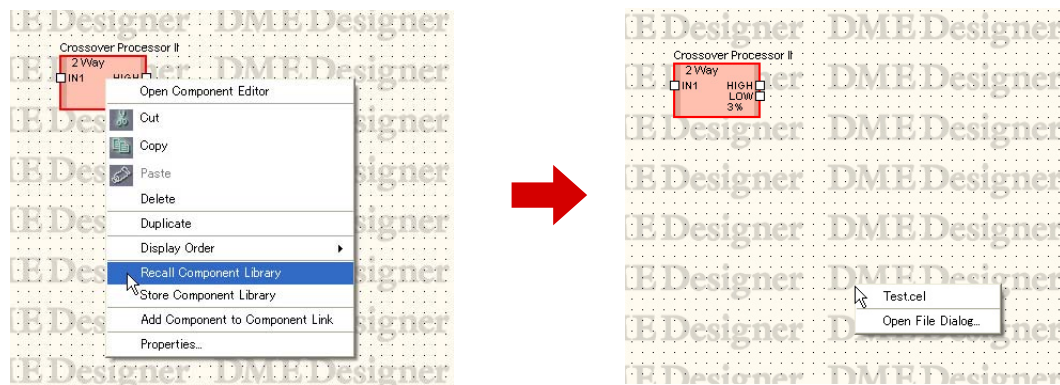

Not only the library name, but also the effect type is displayed in the submenu that appears when you right-click on an SPX component.

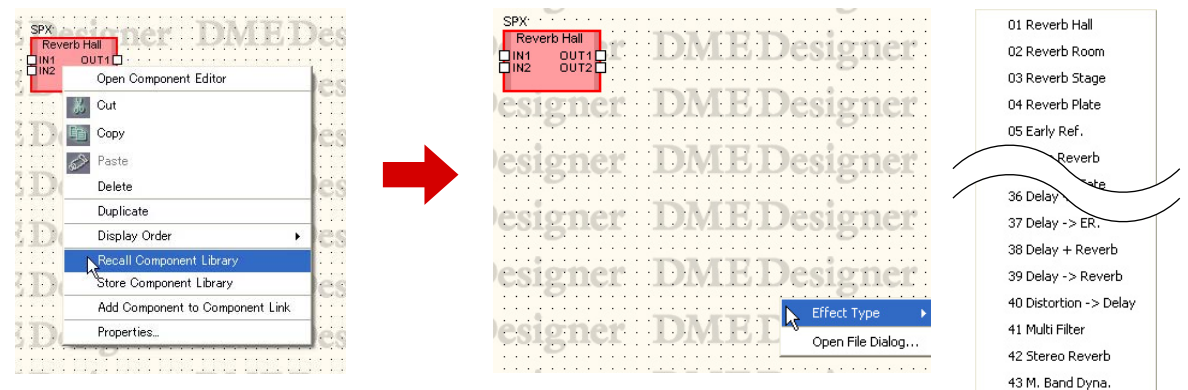

■ Recalling a Library Stored in a Folder Other Than the Default

Libraries not stored in the default folder do not appear on the [Recall Library] menu. You must specify the file you want in order to recall it.

1 Click the [Recall Library] button in the component editor.

The [Recall Library] menu will be displayed.

2 Click the [Recall Library] menu [Open File Dialog].

The “Open” dialog box will be displayed.

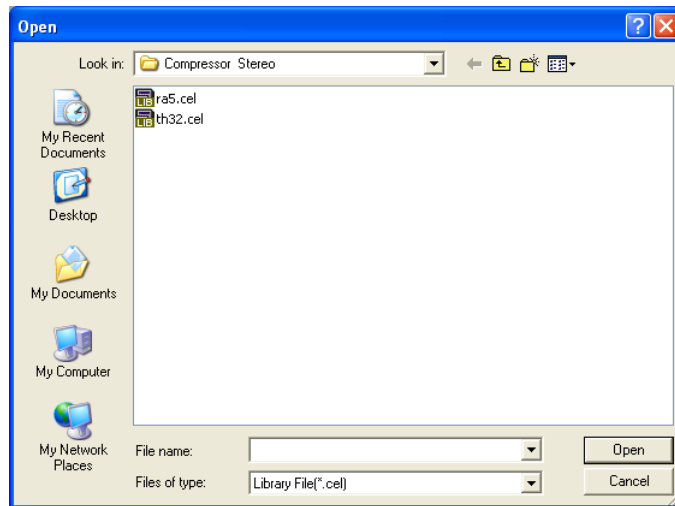

3 Move to the correct folder and select a library file.

4 Click the [Open] button.

Creating Parameter Links

You can group controls (parameters) and link their parameters. You can create parameter link groups and add controls to them in the component editor. Parameter link settings are made in the Parameter Link window. For information about parameter links and the Parameter Link window, see “Parameter Link” (page 94).

NOTE

A parameter can belong to one group only. Furthermore, only parameters of the same type can be grouped.

■ Creating Parameter Links

If you right-click on a control, a context menu will be displayed. The [Add Parameter to Parameter Link] → [Global Link]/[Local Link] → [Add Group] commands create new groups. Controls can be added by right-clicking.

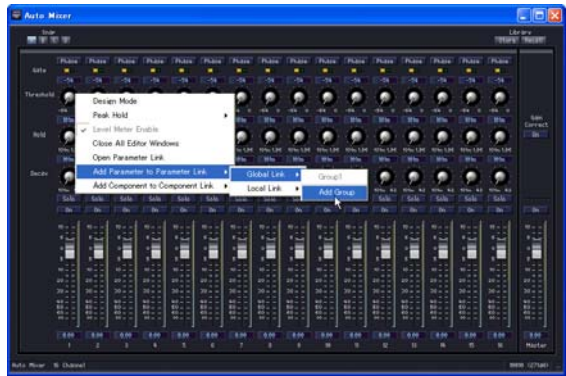

■ Adding Controls to a Group

If you right-click a control in the component editor, a context menu will be displayed. You can create groups or add controls using commands in the [Add Parameter to Parameter Link] submenu. Groups that do not have the same type of parameters will be grayed out and cannot be selected.

Global Link



The group names for global link groups are displayed in the [Global Link] submenu. When you click a group name, a control is added to the group.

Local Link



The group names for local like groups are displayed in the [Local Link] submenu. When you click a group name, a control is added to the group.

■ Adding Multiple Controls

You can select multiple controls in Design Mode. When multiple controls are selected, multiple parameters can be added to a group simultaneously.

Creating Component Links

The same types of parameters can be linked between the same types of component included in a group. Component groups can be created using the component editor, and components can be added to the group as required. Parameter linking is set up via the Parameter Link window. Refer to “Parameter Link” on [page 94](#) for information on the Component Link/Parameter Link window.

NOTE

SPX components and SP2060 units do not support component linking.

■ Creating a New Group

Right-click a component in the component editor to display the contextual menu. [Add Component to Component Link] → [Add Group] creates a new group.



■ Add Components to a Group

Right-click a component in the component editor to display the contextual menu. [Add Component to Component Link] → [group name] adds to an existing group. Groups that are not of the same type will be grayed out and cannot be selected.



Chapter 6 Component Guide

Types of Components

Component Groups

When the Configuration window and User Module window are made active, a component list is displayed in the Toolkit window, and you can use the [Component List] on the [Tools] menu. Components can be separated into groups based on types. In the Toolkit window, component groups are displayed as folders. Some of the groups in the Toolkit window are further divided into subgroups. Click the [+] / [-] buttons to the left of the folders to display the components.

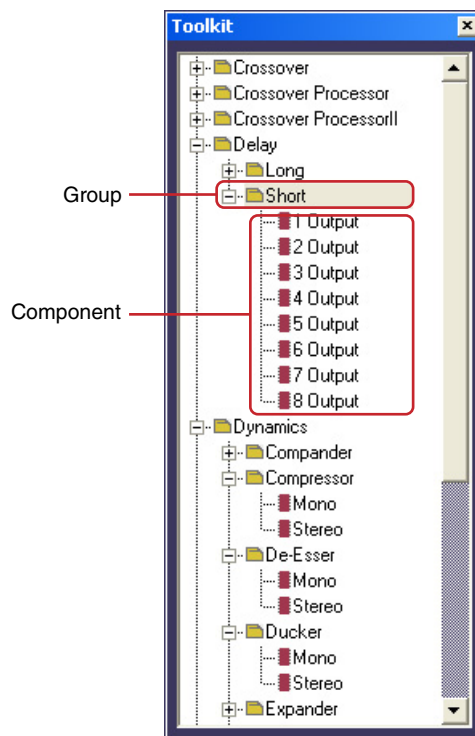

NOTE

When the User Module window is active, [User Module] is not present on the menu.

In the Designer window [Tools] menu → [Component List] menu, component groups are displayed as submenu items. The items with small rightward-facing triangles are groups. Those without triangles are components.

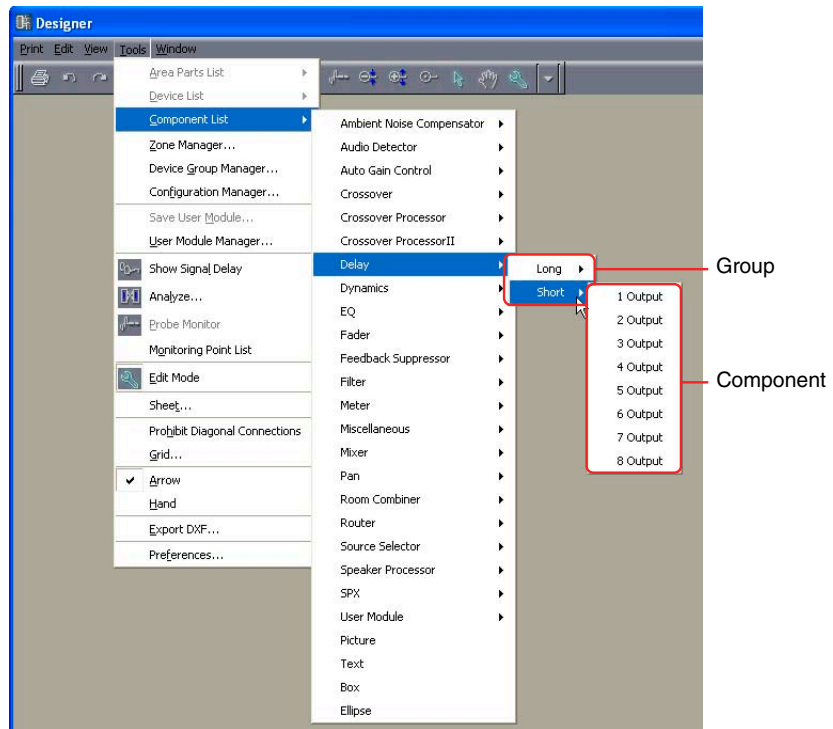

NOTE

When the User Module window is active, [User Module] is not present in the menu.

Component List

Group	Component Variations	DME64N	DME24N	DME Satellite	SP2060
Ambient Noise Compensator	Mono	✓	✓	✓	
	Stereo	✓	✓	✓	
Audio Detector		✓	✓	✓	
Auto Gain Control	Mono	✓	✓	✓	
	Stereo	✓	✓	✓	
Crossover	2 Way	✓	✓	✓	
	3 Way	✓	✓	✓	
	4 Way	✓	✓	✓	
	5 Way	✓	✓	✓	
	6 Way	✓	✓	✓	
Crossover Processor	2 Way	✓	✓	✓	
	3 Way	✓	✓	✓	
	4 Way	✓	✓	✓	
	5 Way	✓	✓	✓	
	6 Way	✓	✓	✓	
Crossover Processor II	2 Way	✓	✓	✓	
	3 Way	✓	✓	✓	

Group		Component Variations	DME64N	DME24N	DME Satellite	SP2060	
Crossover Processor II		4 Way	✓	✓	✓		
		5 Way	✓	✓	✓		
		6 Way	✓	✓	✓		
Delay	Long	1 Output	✓	✓	✓	✓ (*)	
		2 Output	✓	✓	✓		
		3 Output	✓	✓	✓		
		4 Output	✓	✓	✓		
		5 Output	✓	✓	✓		
		6 Output	✓	✓	✓		
		7 Output	✓	✓	✓		
		8 Output	✓	✓	✓		
	Short	1 Output	✓	✓	✓		
		2 Output	✓	✓	✓		
		3 Output	✓	✓	✓		
		4 Output	✓	✓	✓		
		5 Output	✓	✓	✓		
		6 Output	✓	✓	✓		
		7 Output	✓	✓	✓		
		8 Output	✓	✓	✓		
Dynamics	Compander	CompanderH	Mono	✓	✓	✓	
			Stereo	✓	✓	✓	
		CompanderS	Mono	✓	✓	✓	
			Stereo	✓	✓	✓	
	Compressor	Mono	✓	✓	✓		
		Stereo	✓	✓	✓		
	De-Esser	Mono	✓	✓	✓		
		Stereo	✓	✓	✓		
	Ducking	Mono	✓	✓	✓		
		Stereo	✓	✓	✓		
	Expander	Mono	✓	✓	✓		
		Stereo	✓	✓	✓		
	Gate	Mono	✓	✓	✓		
		Stereo	✓	✓	✓		
	Limiter	Mono	✓	✓	✓		
		Stereo	✓	✓	✓		
	Program Ducker	Mono	✓	✓	✓		
		Stereo	✓	✓	✓		

Group			Component Variations	DME64N	DME24N	DME Satellite	SP2060
EQ	GEQ	Mono	7 Band	✓	✓	✓	
			15 Band	✓	✓	✓	
			31 Band	✓	✓	✓	
		Stereo	7 Band	✓	✓	✓	
			15 Band	✓	✓	✓	
			31 Band	✓	✓	✓	
	PEQ	Mono	2 Band	✓	✓	✓	
			3 Band	✓	✓	✓	
			4 Band	✓	✓	✓	
			6 Band	✓	✓	✓	
			8 Band	✓	✓	✓	✓ (*)
		Stereo	2 Band	✓	✓	✓	
			3 Band	✓	✓	✓	
			4 Band	✓	✓	✓	
			6 Band	✓	✓	✓	
8 Band			✓	✓	✓		
Fader			1 Channel	✓	✓	✓	
			2 Channel	✓	✓	✓	
			4 Channel	✓	✓	✓	
			8 Channel	✓	✓	✓	
			12 Channel	✓	✓	✓	
			16 Channel	✓	✓	✓	
Feedback Suppressor				✓	✓		
Filter	BPF	Mono	✓	✓	✓		
		Stereo	✓	✓	✓		
	HPF	Mono	✓	✓	✓		
		Stereo	✓	✓	✓		
	LPF	Mono	✓	✓	✓		
		Stereo	✓	✓	✓		
	Notch	Mono	✓	✓	✓		
		Stereo	✓	✓	✓		
	Programmable BPF	Mono	✓	✓	✓		
		Stereo	✓	✓	✓		
	Programmable HPF	Mono	✓	✓	✓		
		Stereo	✓	✓	✓		
	Programmable LPF	Mono	✓	✓	✓		
		Stereo	✓	✓	✓		

Group		Component Variations	DME64N	DME24N	DME Satellite	SP2060	
Meter	1 Channel		✓	✓	✓		
	2 Channel		✓	✓	✓		
	4 Channel		✓	✓	✓		
	8 Channel		✓	✓	✓		
	12 Channel		✓	✓	✓		
	16 Channel		✓	✓	✓		
Miscellaneous	Oscillator		✓	✓	✓		
	Wav File Player		✓	✓	✓		
Mixer	Auto Mixer		2 Channel	✓	✓	✓	
			4 Channel	✓	✓	✓	
			8 Channel	✓	✓	✓	
	Auto Mixer		12 Channel	✓	✓	✓	
			16 Channel	✓	✓	✓	
	Auto Mixer II		8 Channel	✓	✓	✓	
			16 Channel	✓	✓	✓	
	Delay Matrix	2 Input	2 Output	✓	✓	✓	
			4 Output	✓	✓	✓	
			8 Output	✓	✓	✓	
			12 Output	✓	✓	✓	
			16 Output	✓	✓	✓	
		4 Input	2 Output	✓	✓	✓	
			4 Output	✓	✓	✓	
			8 Output	✓	✓	✓	
			12 Output	✓	✓	✓	
			16 Output	✓	✓	✓	
		8 Input	2 Output	✓	✓	✓	
			4 Output	✓	✓	✓	
			8 Output	✓	✓	✓	
			12 Output	✓	✓	✓	
			16 Output	✓	✓	✓	
	Matrix Mixer	2 Input	1 Output	✓	✓	✓	
			2 Output	✓	✓	✓	
		4 Input	1 Output	✓	✓	✓	
			2 Output	✓	✓	✓	
			4 Output	✓	✓	✓	
			8 Output	✓	✓	✓	
		8 Input	16 Output	✓	✓	✓	
			1 Output	✓	✓	✓	
			2 Output	✓	✓	✓	
			4 Output	✓	✓	✓	
8 Output	✓		✓	✓			
		16 Output	✓	✓	✓		

Group			Component Variations	DME64N	DME24N	DME Satellite	SP2060
Mixer	Matrix Mixer	8 Input	32 Output	✓	✓	✓	
		12 Input	1 Output	✓	✓	✓	
			2 Output	✓	✓	✓	
			4 Output	✓	✓	✓	
			8 Output	✓	✓	✓	
			12 Output	✓	✓	✓	
		16 Input	1 Output	✓	✓	✓	
			2 Output	✓	✓	✓	
			4 Output	✓	✓	✓	
			8 Output	✓	✓	✓	
			12 Output	✓	✓	✓	
		16 Input	16 Output	✓	✓	✓	
			32 Output	✓	✓	✓	
			64 Output	✓			
		24 Input	24 Output	✓	✓	✓	
		32 Input	16 Output	✓	✓	✓	
	32 Output		✓	✓	✓		
	64 Output		✓				
	64 Input	32 Output	✓				
		64 Output	✓				
Simple Mixer	16 Channel		✓	✓	✓		
	24 Channel		✓	✓	✓		
Pan	LCR	1 Channel		✓	✓	✓	
		2 Channel		✓	✓	✓	
		4 Channel		✓	✓	✓	
		8 Channel		✓	✓	✓	
		12 Channel		✓	✓	✓	
		16 Channel		✓	✓	✓	
	LR	1 Channel		✓	✓	✓	
		2 Channel		✓	✓	✓	
		4 Channel		✓	✓	✓	
		8 Channel		✓	✓	✓	
		12 Channel		✓	✓	✓	
		16 Channel		✓	✓	✓	
	Surround	3-1		✓	✓	✓	
		5.1		✓	✓	✓	
		6.1		✓	✓	✓	

Group		Component Variations	DME64N	DME24N	DME Satellite	SP2060
Room Combiner	Mono	4 Room	✓	✓	✓	
		8 Room	✓	✓	✓	
		12 Room	✓	✓	✓	
		16 Room	✓	✓	✓	
	Stereo	4 Room	✓	✓	✓	
		8 Room	✓	✓	✓	
		12 Room	✓	✓	✓	
		16 Room	✓	✓	✓	
Router	1 Input	2 Output	✓	✓	✓	
		4 Output	✓	✓	✓	
		8 Output	✓	✓	✓	
		12 Output	✓	✓	✓	
		16 Output	✓	✓	✓	
	2 Input	2 Output	✓	✓	✓	
		4 Output	✓	✓	✓	
		8 Output	✓	✓	✓	
Router	2 Input	12 Output	✓	✓	✓	
		16 Output	✓	✓	✓	
	4 Input	2 Output	✓	✓	✓	
		4 Output	✓	✓	✓	
		8 Output	✓	✓	✓	
		12 Output	✓	✓	✓	
		16 Output	✓	✓	✓	
	8 Input	2 Output	✓	✓	✓	
		4 Output	✓	✓	✓	
		8 Output	✓	✓	✓	
		12 Output	✓	✓	✓	
		16 Output	✓	✓	✓	
	12 Input	2 Output	✓	✓	✓	
		4 Output	✓	✓	✓	
		8 Output	✓	✓	✓	
		12 Output	✓	✓	✓	
		16 Output	✓	✓	✓	
	16 Input	2 Output	✓	✓	✓	
		4 Output	✓	✓	✓	
		8 Output	✓	✓	✓	
12 Output		✓	✓	✓		
16 Output		✓	✓	✓		
32 Input	32 Output	✓	✓	✓		

Group		Component Variations	DME64N	DME24N	DME Satellite	SP2060
Source Selector	3 Position	1 Channel	✓	✓	✓	✓ (*)
	4 Position	1 Channel	✓	✓	✓	
		2 Channel	✓	✓	✓	
		6 Channel	✓	✓	✓	
	8 Position	1 Channel	✓	✓	✓	
		2 Channel	✓	✓	✓	
		6 Channel	✓	✓	✓	
16 Position	1 Channel	✓	✓	✓		
Speaker Processor		1 Way	✓	✓	✓	✓ (*)
		2 Way	✓	✓	✓	✓ (*)
		3 Way	✓	✓	✓	✓ (*)
		4 Way	✓	✓	✓	✓ (*)
		5 Way	✓	✓	✓	✓ (*)
		6 Way	✓	✓	✓	✓ (*)
SPX			✓	✓		
AEC		AEC Component Editor	✓	✓		
Slot		Slot In Component Editor	✓	✓	✓	
		Slot Out Component Editor	✓	✓	✓	
Cascade		Cascade In Component Editor	✓ (*)			
		Cascade Out Component Editor	✓ (*)			
Analog Input/Output		Analog Input Component Editor		✓ (*)	✓ (*)	
		Analog Output Component Editor		✓ (*)	✓ (*)	
SP2060 Input/Output		SP2060 Input Component Editor				✓ (*)
		SP2060 Output Component Editor				✓ (*)
CobraNet Input/Output		CobraNet Input Component Editor			✓ (*)	
		CobraNet Output Component Editor			✓ (*)	
EtherSound Input/Output		EtherSound Input Component Editor			✓ (*)	
		EtherSound Output Component Editor			✓ (*)	
MY-Card		Component Editor of each card	✓	✓		
Remote Controlled Head Amp		Component Editor of each device	✓	✓	✓	

(*) Parameter edit only

Ambient Noise Compensator

The Ambient Noise Compensator automatically adjusts program source level to compensate for ambient noise levels. Mono and stereo components are provided.

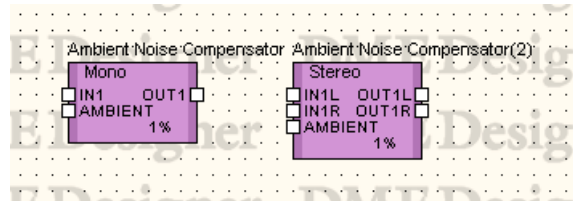

Double-click the component to open the component editor. The component editor is the same for stereo and mono types, the only difference being the number of channels.

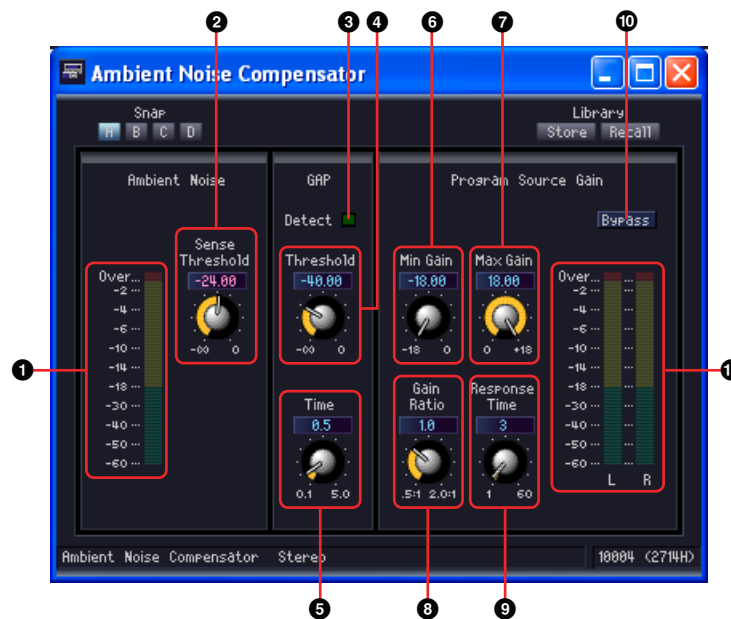

	Section	Parameter	Setting Range	Function
1	Ambient Noise	Level Meter		Displays the ambient noise level.
2		Sense Threshold	$-\infty$ to 0.00 dB	Sets the average ambient noise level. The program source level is increased when this threshold level is exceeded. The program source level is lowered when this threshold level is not reached.
3	Gap	Detect		Lights when a gap is detected in the program source.
4		Threshold	$-\infty$ to 0.00 dB	Sets the program source threshold level. A “gap” is assumed if the program source level remains below the threshold for a specified amount of time.
5		Time	0.1 to 5.0 sec	Sets the time interval for gap detection.
6	Program Source Gain	Min Gain	-18.0 to 0.0 dB	Sets the minimum level for program source level compensation.
7		Max Gain	0.0 to +18.0 dB	Sets the maximum level for program source level compensation.
8		Gain Ratio	0.5:1 to 2.0:1	Sets the amount of program source level compensation. This is specified as a ratio between the amount of program source level compensation, and the amount the ambient noise level has exceeded the threshold.
9		Response Time	1 to 60 sec	Sets the response time for level compensation.

	Section	Parameter	Setting Range	Function
10		Bypass	ON/OFF	Turns compensation on or off.
11		Level Meter		Displays the program source output level after compensation.

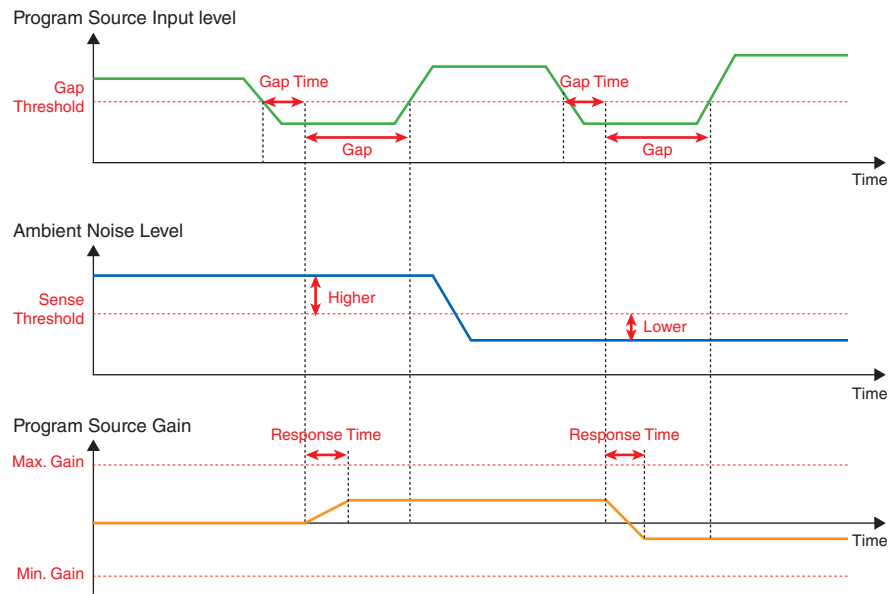

Audio Detector

The Audio Detector detects the presence of an audio signal and can light an indicator, trigger a GPI output, or perform other functions. This function can be useful for checking cable connections, for example.

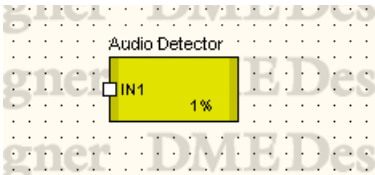

Double-click the component to open the component editor.

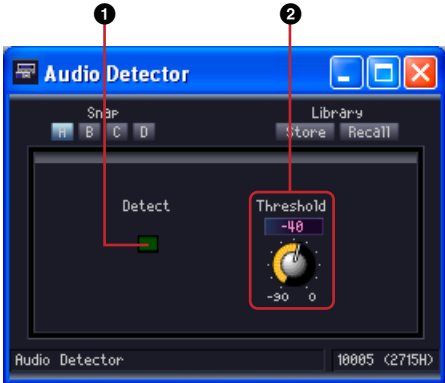

	Parameter	Setting Range	Function
1	Detect		Lights when the signal level exceeds the threshold.
2	Threshold	-90 to 0 dB	Sets the threshold level for signal detection.

Auto Gain Control

The Auto Gain Control component automatically adjusts gain in response to input level, and is a convenient way to maintain a constant output level with an input signal that varies in level. Mono and stereo types are provided.

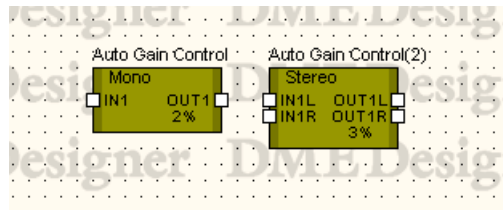

Double-click the component to open the component editor. The component editor is the same for stereo and mono types, the only difference being the number of channels.

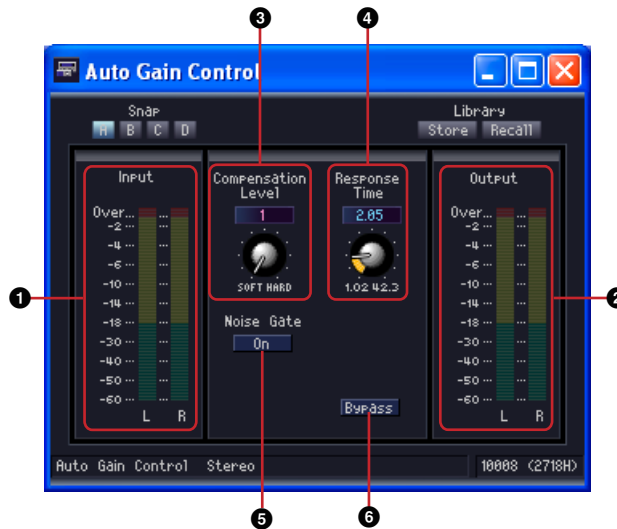

Name		Function	
1	Input Meter	Displays the input signal level.	
2	Output Meter	Displays the compensated output signal level.	
Parameter	Setting Range	Function	
3	Compensation Level	1 to 5	Sets the amount of gain compensation. Higher settings produce more gain compensation. Caution: sudden changes in this setting can result in output level changes.
4	Response Time	*1	Sets the response time for gain compensation. Effective for upward gain compensation (gain increase), this parameter specifies the time it will take for a gain increase of 6 dB. This parameter does not affect gain reduction.
5	Noise Gate	ON/OFF	Turns the noise gate compensation on or off.
6	Bypass	ON/OFF	Turns gain compensation on or off.

*1 The setting range of Response Time varies according to the operating frequency as follows:
 44.1kHz: 447 msec to 2.14 sec, 48kHz: 411 msec to 1.96 sec, 88.2kHz: 224 msec to 1.07 sec, 96kHz: 206 msec to 984 msec

Crossover

Separates input signals into multiple frequency channels and outputs them. The following five types of components are available in the Crossover group: 2 Way, 3 Way, 4 Way, 5 Way, and 6 Way. Crossover components have a single input and multiple outputs.

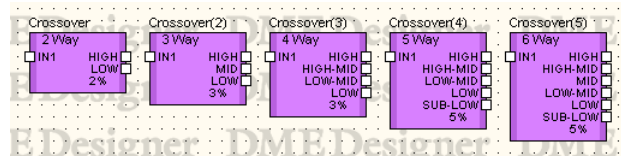

Double-click a component to display the component editor for it.

Crossover component



	Name		Function	
1	Crossover Curve		Displays the level of each frequency band, distinguished by color.	
	Section	Parameter	Setting Range	Function
2	Input	Level	$-\infty$ to +10 dB	Sets the input signal level.
3	Output	Level	$-\infty$ to ± 0 dB	Sets the output signal level for each frequency band.
4		Mute	ON/OFF	Mutes the output signal level for each frequency band.
5		Phase	ON/OFF	Reverses the phase of the output signal for each frequency band.
6	Frequency		20 Hz to 20 kHz	Sets the cross frequency between each frequency band.

	Section	Parameter	Setting Range	Function
7	LPF	Type	Thru 6 dB/Oct 12 dB/Oct AdjustGc 12 dB/Oct Butwrth 12 dB/Oct Bessel 12 dB/Oct Linkwitz 18 dB/Oct AdjustGc 18 dB/Oct Butwrth 18 dB/Oct Bessel 24 dB/Oct AdjustGc 24 dB/Oct Butwrth 24 dB/Oct Bessel 24 dB/Oct Linkwitz 36 dB/Oct AdjustGc 36 dB/Oct Butwrth 36 dB/Oct Bessel 48 dB/Oct AdjustGc 48 dB/Oct Butwrth 48 dB/Oct Bessel 48 dB/Oct Linkwitz	Sets the attenuation for each octave and the filter type. [THRU] turns off the filter.
8		Frequency	20 Hz to 20 kHz	Sets the LPF cutoff frequency.
9		Gc	-6 dB to +6 dB	When [AdjustGc] (Adjustable Gc) is selected for [Type], this sets the gain for the cutoff frequency.
10	HPF	Type	Thru 6 dB/Oct 12 dB/Oct AdjustGc 12 dB/Oct Butwrth 12 dB/Oct Bessel 12 dB/Oct Linkwitz 18 dB/Oct AdjustGc 18 dB/Oct Butwrth 18 dB/Oct Bessel 24 dB/Oct AdjustGc 24 dB/Oct Butwrth 24 dB/Oct Bessel 24 dB/Oct Linkwitz 36 dB/Oct AdjustGc 36 dB/Oct Butwrth 36 dB/Oct Bessel 48 dB/Oct AdjustGc 48 dB/Oct Butwrth 48 dB/Oct Bessel 48 dB/Oct Linkwitz	Sets the attenuation for each octave and the filter type. [THRU] turns off the filter.
11		Frequency	20 Hz to 20 kHz	Sets the HPF cutoff frequency.
12		Gc	-6 dB to +6 dB	When [AdjustGc] (Adjustable Gc) is selected for [Type], this sets the gain for the cutoff frequency.

The number of output channels varies according to the component variation.

2 Way	Low/High
3 Way	Low/Mid/High
4 Way	Low/Low-Mid/High-Mid/High
5 Way	Sub-Low/Low/Low-Mid/High-Mid/High
6 Way	Sub-Low/Low/Low-Mid/Mid/High-Mid/High

Set the attenuation curve for the lowest band and the middle bands with the Low Pass Filter (LPF) and High Pass Filter (HPF), and the highest band with HPF. Each frequency band has its own color, with Low being red, Mid being green, and so on. These correspond to the colors of the lines on the graph.

■ Graphic Control Points

The graph control points show [Output Level] and [Frequency]. As you modify the parameters using the knobs and edit boxes, the control points move. Also, as you drag the points, the [Output Level] and [Frequency] parameters reflect the changes you make.



You can adjust the [Output Level] parameter by vertically dragging the control point in the center of each curve.



Changing the [Output Level] Parameter

You can adjust the [Frequency] parameter by horizontally dragging the control point at the intersection of the curves for each frequency band.



Changing the [Frequency] Parameter

■ LFP/HPF

[Type] sets the attenuation slope and the filter type for the LPF and HPF. The selected items are displayed on the buttons. Clicking these buttons displays a menu. Combinations of six slope types and four filter types are available. [6dB/Oct], [12dB/Oct], [18dB/Oct], [24dB/Oct], [36dB/Oct], and [48dB/Oct] set the attenuation per octave. A low value produces gentle attenuation. A large value produces sudden attenuation.

Type



- **THRU**
No filter is applied. There is no attenuation, which produces a level line at all frequencies.
- **AdjustGc (Adjustable Gc)**
With this setting, you can adjust Gc (gain on the cutoff frequency) between -6 dB and +6 dB. If you set -3 dB it becomes a Butterworth filter. If you set -6 dB, it becomes Linkwitz-Riley filter. When you select Adjustable Gc, the Gc knob is displayed.



- **Butwrth (Butterworth)**
This filter has the most general characteristics. The pass band is flat and the gain for the cutoff frequency is -3 dB.
- **Bessel**
For curves where phase characteristics are important, Bessel has gentler attenuation than Butterworth, and there is little distortion of the waveform when square waves are passed through.
- **Linkwitz (Linkwitz-Riley)**
As second-order filters, the sum of the output voltages for LPF and HPF have a gain of 0 dB across the entire band. The pass band is flat, but the cutoff frequency gain is -6 dB.

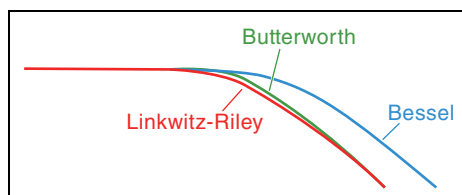

Crossover Processor

A crossover processor consists of a crossover, delay, parametric equalizer, and compressor. After the input signal is processed by the crossover, effects of the delay, parametric equalizer, and compressor are applied to each frequency band. The following two types are available in the Crossover Processor group: Crossover Processor and Crossover Processor II.

Crossover Processor

The following five types of components are available in the Crossover Processor group: 2 Way, 3 Way, 4 Way, 5 Way, and 6 Way. Crossover processors have a single input and 2 to 6 outputs.

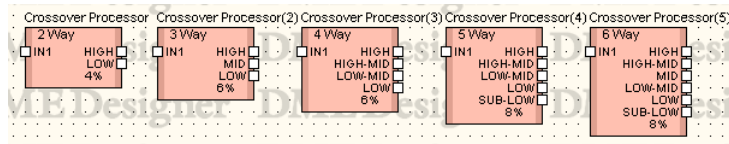

Double-click a component to display the component editor for it. Band numbers may vary depending on the component, but they share a common configuration in the component editor.

If you click the [Crossover], [Compressor], [PEQ], or [Delay] button in the [Navigator] section, an editor for the crossover, compressor, parametric equalizer, or delay will be displayed in a separate window. A separate component editor will open for each output channel (such as Low or Mid) when you click on the compressor, parametric equalizer, or delay.

Component editor for Crossover Processor



	Section	Parameter	Setting Range	Function
1	Navigator	Crossover	–	This opens the crossover editor window.
2		Delay	–	This opens the delay editor window.
3		PEQ	–	This opens the parametric equalizer editor window.
4		Compressor	–	This opens the compressor editor window.
5	Input	Level	$-\infty$ to +10 dB	Sets the input signal level.
6	Output	Level	$-\infty$ to +10 dB	Sets the output signal level for each frequency band.
7		Mute	ON/OFF	Mutes the signal for each frequency band.
8		Phase	ON/OFF	Reverses the phase of the output signal for each frequency band.

The output number varies according to the component variation.

2 Way	Low/High
3 Way	Low/Mid/High
4 Way	Low/Low-Mid/High-Mid/High
5 Way	Sub-Low/Low/Low-Mid/High-Mid/High
6 Way	Sub-Low/Low/Low-Mid/Mid/High-Mid/High

Set the attenuation curve for the lowest band and the middle bands with the Low Pass Filter (LPF) and High Pass Filter (HPF), and the highest band with HPF. Each frequency band has its own color, with Low being red, Mid being green, and so on. These correspond to the colors of the lines on the graph.

■ Crossover

When you click the [Crossover] button for the crossover processor, it opens the crossover editor window.

[Crossover Processor-Crossover] editor window



	Name			Function
❶	Crossover Curve			Displays the level of each frequency channel, distinguished by color.
	Section	Parameter	Setting Range	Function
❷	Frequency		20 Hz to 20 kHz	Sets the cross frequency between each frequency band.
❸	LPF	Type	Thru 6 dB/Oct 12 dB/Oct AdjustGc 12 dB/Oct Butwrth 12 dB/Oct Bessel 12 dB/Oct Linkwitz 18 dB/Oct AdjustGc 18 dB/Oct Butwrth 18 dB/Oct Bessel 24 dB/Oct AdjustGc 24 dB/Oct Butwrth 24 dB/Oct Bessel 24 dB/Oct Linkwitz 36 dB/Oct AdjustGc 36 dB/Oct Butwrth 36 dB/Oct Bessel 48 dB/Oct AdjustGc 48 dB/Oct Butwrth 48 dB/Oct Bessel 48 dB/Oct Linkwitz	Sets the attenuation for each octave and the filter type. [THRU] turns off the filter.
❹		Frequency	20 Hz to 20 kHz	Sets the LPF cutoff frequency.
❺		Gc	-6 dB to +6 dB	When [AdjustGc] (Adjustable Gc) is selected for [Type], this sets the gain for the cutoff frequency.
❻	HPF	Type	Thru 6 dB/Oct 12 dB/Oct AdjustGc 12 dB/Oct Butwrth 12 dB/Oct Bessel 12 dB/Oct Linkwitz 18 dB/Oct AdjustGc 18 dB/Oct Butwrth 18 dB/Oct Bessel 24 dB/Oct AdjustGc 24 dB/Oct Butwrth 24 dB/Oct Bessel 24 dB/Oct Linkwitz 36 dB/Oct AdjustGc 36 dB/Oct Butwrth 36 dB/Oct Bessel 48 dB/Oct AdjustGc 48 dB/Oct Butwrth 48 dB/Oct Bessel 48 dB/Oct Linkwitz	Sets the attenuation for each octave and the filter type. [THRU] turns off the filter.
❼		Frequency	20 Hz to 20 kHz	Sets the HPF cutoff frequency.
❽		Gc	-6 dB to +6 dB	When [AdjustGc] (Adjustable Gc) is selected for [Type], this sets the gain for the cutoff frequency.

■ Delay

When you click the [Delay] button for the crossover processor, it opens the delay editor window. Here you can set the delay for each frequency band.

[Crossover Processor - Delay] editor window



	Parameter	Setting Range	Function
1	Delay	ms: 0 to 500 Sample: the range depends on the Fs value. Meter: 0 to 171.8 Feet: 0 to 563.6 Frame: the range depends on the Frame value. Beat: the range depends on the Beat value.	Sets the delay time.
2	Level	-∞ to ±0 dB	Sets the output signal level for each channel
3	On	ON/OFF	Turns delay ON.
4	Mute	ON/OFF	Mutes the signal for each frequency band.
5	Delay Scale	ms Sample Meter Feet Frame Beat	Selects the units for setting the delay time. The selected button will light up, and the units in the [Delay] edit box will change. If [Beat] is selected, use the knob to set the BPM (beats/minute).

NOTE

Delay Scale does not support the parameter link feature. Refer to "Parameter Link" on [page 94](#) for information on parameter linking.

■ Parametric Equalizer

When you click [PEQ] button for the crossover processor, it opens the parametric equalizer editor window. Here you can make parametric equalizer settings for each frequency band.

[Crossover Processor-PEQ] editor window

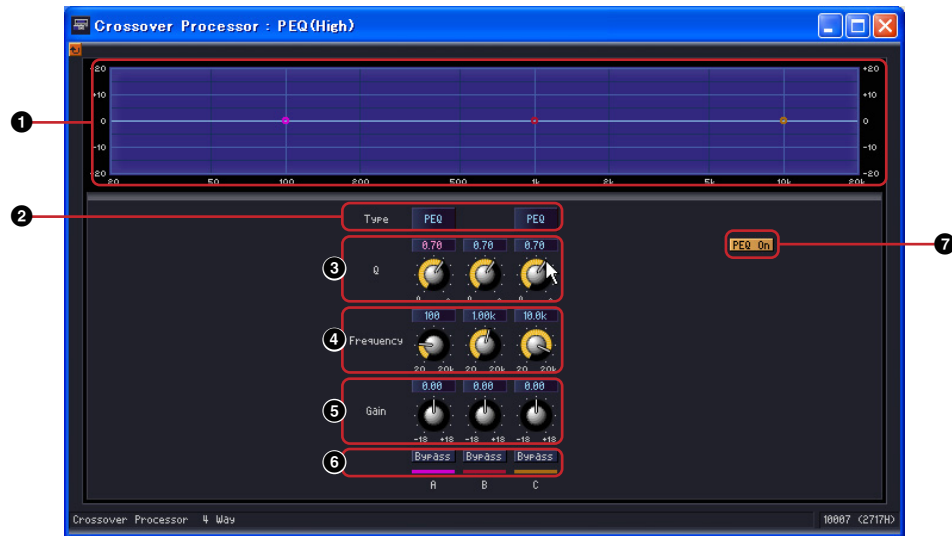

	Name		Function
1	PEQ Curve		Displays the PEQ curve.
	Parameter	Setting Range	Function
2	Type	PEQ L.SHELF 6 dB/Oct L.SHELF 12 dB/Oct H.SHELF 6 dB/Oct H.SHELF 12 dB/Oct HPF LPF	Select the filter type from a menu.
3	Q:	0.1 to 16.0	Sets the frequency band width for each band.
4	Frequency	20 Hz to 20 kHz	Sets the frequency for each band.
5	Gain	-18 dB to +18 dB	Sets the gain for each band.
6	Bypass	ON/OFF	Turns ON bypass for each band.
7	PEQ On	ON/OFF	Turns the PEQ ON.

■ Compressor

When you click the [Compressor] button for the crossover processor, it opens the compressor editor window. Here you can make compressor settings for each frequency band.

[Crossover Processor-Compressor] editor window

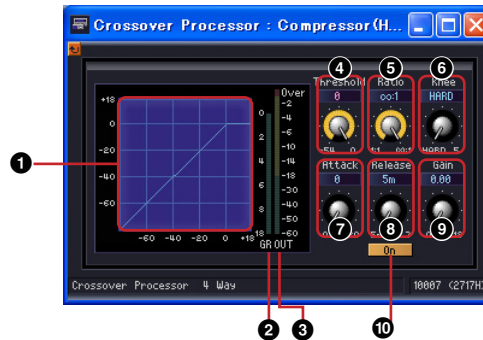

Name		Function	
1	Compressor Curve	Displays results graphically. The horizontal axis is the input signal level, and the vertical axis is the output level.	
2	Gain Reduction Meter	Displays the gain reduction attenuation.	
3	Output Meter	Displays the output signal level.	
Parameter	Setting Range	Function	
4	Threshold	-54 dB to ± 0 dB	Sets the threshold value.
5	Ratio	1:1 to ∞ :1	Sets the compression ratio.
6	Knee	HARD, 1, 2, 3, 4, 5	Sets the way compression is applied.
7	Attack	0 to 120 ms	Sets the attack time.
8	Release	44.1 kHz: 6 ms to 46 s 48 kHz: 5 ms to 42.3 s 88.2 kHz: 3 ms to 23 s 96 kHz: 3 ms to 21.1 s	Sets the release time. The setting range may vary, depending on the operating frequency.
9	Gain	± 0 dB to +18 dB	Sets the output gain.
10	On	ON/OFF	Turns the compressor ON. When you turn this button OFF, the compressor is bypassed.

Crossover Processor II

The following five types of components are available in the Crossover Processor II group: 2 Way, 3 Way, 4 Way, 5 Way, and 6 Way. Crossover processor II components have a single input and 2 to 6 outputs.

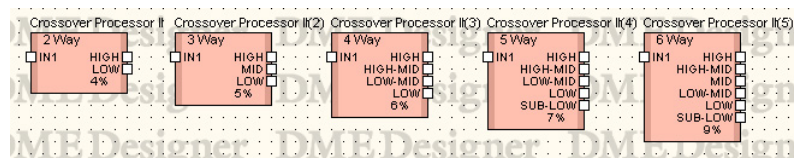

Double-click a component to display the component editor for it. The number of bands may vary depending on the component, but they share a common configuration in the component editor. There are input and output level meters in the upper part of the window. If you click the [Crossover], [Delay], [PEQ], or [Compressor] button in the [Navigator] section, an editor for the crossover, delay, parametric equalizer, or compressor will be displayed in a separate window. A separate component editor will open for each output channel (such as Low or Mid) when you click on the delay, parametric equalizer, or compressor.

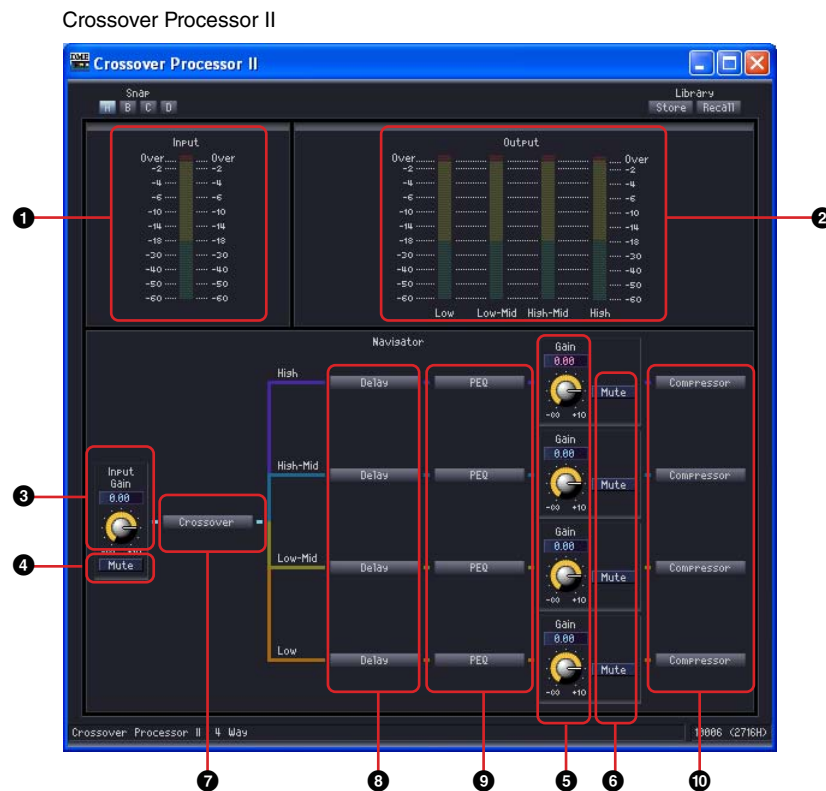

Name		Function	
1	Input Meter	Displays the input signal level.	
2	Output Meter	Displays the output signal level.	
Section	Parameter	Setting Range	Function
3	Gain	$-\infty$ to +10 dB	Sets the input signal level.
	Mute	ON/OFF	Mutes the input signal.
5	Gain	$-\infty$ to +10 dB	Sets the output signal level for each frequency band.
	Mute	ON/OFF	Mutes the output signal for each frequency band.

	Name			Function
7	Navigator	Crossover	--	This opens the crossover editor window.
8		Delay	--	This opens the delay editor window.
9		PEQ	--	This opens the parametric equalizer editor window.
10		Compressor	--	This opens the compressor editor window.

■ Crossover

When you click the [Crossover] button for the crossover processor, it opens the crossover editor window.

Crossover Processor II component editor

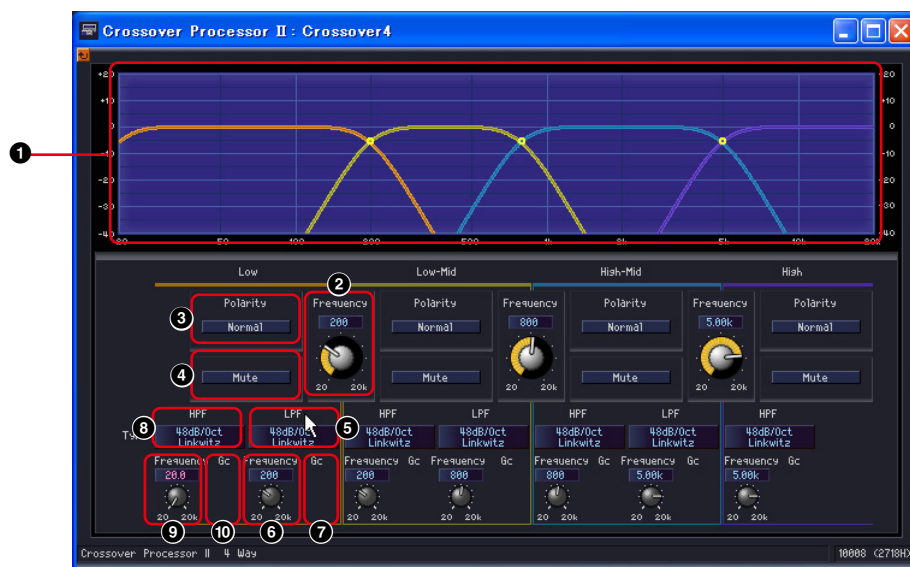

	Name			Function
1	Crossover Curve			Displays the level of each frequency band, distinguished by color.
	Section	Parameter	Setting Range	Function
2	Frequency		20 Hz to 20 kHz	Sets the cross frequency between each frequency band.
3	Polarity		Normal/Inverted	Reverses the output signal phase for each frequency band.
4	Mute		ON/OFF	Mutes the signal for each frequency band. This is linked to the Mute setting in the original window. The display appears as a dotted line when muted.

	Section	Parameter	Setting Range	Function
5	LPF	Type	Thru 6 dB/Oct 12 dB/Oct AdjustGc 12 dB/Oct Butrwrth 12 dB/Oct Bessel 12 dB/Oct Linkwitz 18 dB/Oct AdjustGc 18 dB/Oct Butrwrth 18 dB/Oct Bessel 24 dB/Oct AdjustGc 24 dB/Oct Butrwrth 24 dB/Oct Bessel 24 dB/Oct Linkwitz 36 dB/Oct AdjustGc 36 dB/Oct Butrwrth 36 dB/Oct Bessel 48 dB/Oct AdjustGc 48 dB/Oct Butrwrth 48 dB/Oct Bessel 48 dB/Oct Linkwitz	Sets the attenuation for each octave and the filter type. [THRU] turns off the filter.
6		Frequency	20 Hz to 20 kHz	Sets the LPF cutoff frequency.
7		Gc	-6 dB to 6 dB	When [Adjustable Gc] is selected for [Type], this sets the gain for the cutoff frequency.
8	HPF	Type	Thru 6 dB/Oct 12 dB/Oct AdjustGc 12 dB/Oct Butrwrth 12 dB/Oct Bessel 12 dB/Oct Linkwitz 18 dB/Oct AdjustGc 18 dB/Oct Butrwrth 18 dB/Oct Bessel 24 dB/Oct AdjustGc 24 dB/Oct Butrwrth 24 dB/Oct Bessel 24 dB/Oct Linkwitz 36 dB/Oct AdjustGc 36 dB/Oct Butrwrth 36 dB/Oct Bessel 48 dB/Oct AdjustGc 48 dB/Oct Butrwrth 48 dB/Oct Bessel 48 dB/Oct Linkwitz	Sets the attenuation for each octave and the filter type. [THRU] turns off the filter.
9		Frequency	20 Hz to 20 kHz	Sets the HPF cutoff frequency.
10		Gc	-6 dB to 6 dB	When [Adjustable Gc] is selected for [Type], this sets the gain for the cutoff frequency.

■ Delay

When you click the [Delay] button for the crossover processor, it opens the delay editor window. Here you can set the delay for each frequency band.



	Parameter	Setting Range	Function
1	Delay	ms: 0 to 500 Sample: the range depends on the Fs value. Meter: 0 to 171.8 Feet: 0 to 563.6 Frame: the range depends on the Frame value. Beat: the range depends on the Beat value.	Sets the delay time.
2	Level	-∞ to ±0 dB	Sets the output signal level for each channel.
3	On	ON/OFF	Turns delay ON.
4	Delay Scale	ms Sample Meter Feet Frame Beat	Selects the units for setting the delay time. The selected button will light up, and the units in the [Delay] edit box will change. If [Beat] is selected, use the knob to set the BPM (beats/minute).

NOTE

Delay Scale does not support the parameter link feature. Refer to “Parameter Link” on [page 94](#) for information on parameter linking.

■ Parametric Equalizer

When you click the [PEQ] button for the crossover processor, it opens the parametric equalizer editor window. Here you can make parametric equalizer settings for each frequency band.

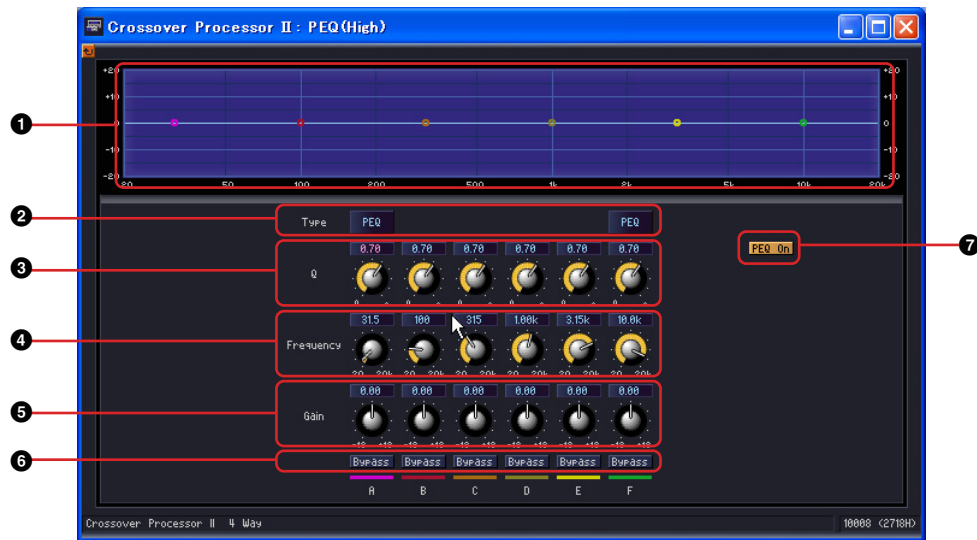

	Name		Function
1	PEQ Curve		Displays the PEQ curve.
	Parameter	Setting Range	Function
2	Type	PEQ L.SHELF 6 dB/Oct L.SHELF 12 dB/Oct H.SHELF 6 dB/Oct H.SHELF 12 dB/Oct HPF LPF	Select the filter type from the menu.
3	Q	0.1 to 16.0	Sets the band width of each band.
4	Frequency	20 Hz to 20 kHz	Sets the frequency of each band.
5	Gain	-18 dB to +18 dB	Sets the frequency gain for each band.
6	Bypass	ON/OFF	Turns ON bypass for each band.
7	PEQ On	ON/OFF	Turn the PEQ ON.

■ Compressor

When you click the [Compressor] button for the crossover processor, it opens the compressor editor window. Here you can make compressor settings for each frequency band.

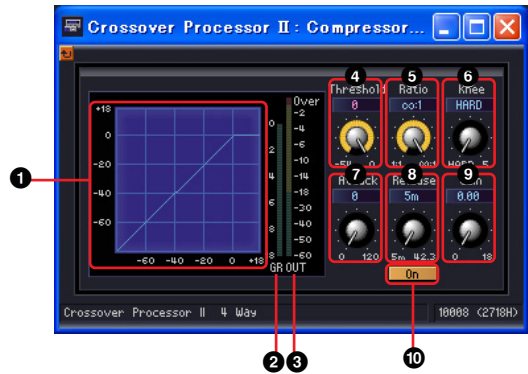

Name		Function	
1	Compressor Curve	Displays results graphically. The horizontal axis is the input signal level, and the vertical axis is the output level.	
2	Gain Reduction Meter	Displays the gain reduction attenuation.	
3	Output Meter	Displays the output signal level.	
Parameter	Setting Range	Function	
4	Threshold	-54 dB to ±0 dB	Sets the threshold value.
5	Ratio	1:1 to ∞:1	Sets the compression ratio.
6	Knee	HARD, 1, 2, 3, 4, 5	Sets the way compression is applied.
7	Attack	0 to 120 ms	Sets the attack time.
8	Release	44.1 kHz: 6 ms to 46 s 48 kHz: 5 ms to 42.3 s 88.2 kHz: 3 ms to 23 s 96 kHz: 3 ms to 21.1 s	Sets the release time. The setting range may vary, depending on the operating frequency.
9	Gain	±0 dB to +18 dB	Sets the output gain.
10	On	ON/OFF	Turns the compressor ON. When you turn this button OFF, the compressor is bypassed.

Delay

This is a multi-tap delay that provides independent delay and level control for each output. You can specify the delay time in milliseconds, samples, meters, feet, time code frames, or number of beats. Within the delay group, there are two subgroups called Long and Short. Each has a different setting range for the delay.

NOTE

The maximum delay time that can be set internally is approximately 43.6 seconds for the DME64N and 21.8 seconds for the DME24N, regardless of the sampling frequency.

Delay Long

Delay long components are available with from one to eight outputs. Each has a single input and from one to eight outputs.

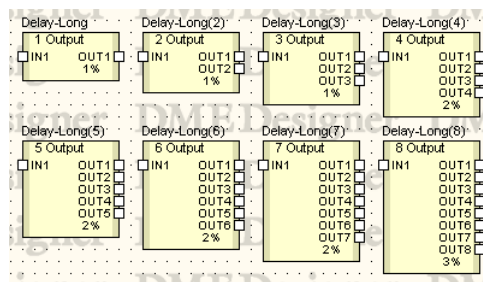

Double-click a component to display the component editor for it. Only the number of outputs in each component is different. The other parts are the same.

Delay Long Component Editor



	Section	Parameter	Setting Range	Function
1	Delay	All Bypass	ON/OFF	Bypasses from input to output.
2	Input	Level	$-\infty$ to ± 0 dB	Sets the input signal level.
3		Mute	ON/OFF	Mute the input signal.
4	Delay Tap	Delay	ms: 0 to 1300 Sample: the range depends on the Fs value. Meter: 0 to 446.7 Feet: 0 to 1465.4 Frame: the range depends on the Frame value. Beat: the range depends on the Beat value.	Sets the delay time. There are two edit boxes, displaying milliseconds and the units selected for [Delay Scale].
5		Level	$-\infty$ to ± 0 dB	Sets the output signal level for each channel.
6		On	ON/OFF	Turns ON each channel's delay.
7		Mute	ON/OFF	Turns ON muting for each channel's output.

	Section	Parameter	Setting Range	Function
8	Delay Scale	ms Sample Meter Feet Frame Beat		Selects the units for setting the delay time. The selected button will light up, and the units in the [Delay] edit box will change. If [Beat] is selected, use the knob to set the BPM (beats/minute).

NOTE
 Delay Scale does not support the parameter link feature. Refer to “Parameter Link” on page 94 for information on parameter linking.

Delay Short

Delay short components are available with from one to eight outputs. Each has a single input and from one to eight outputs.

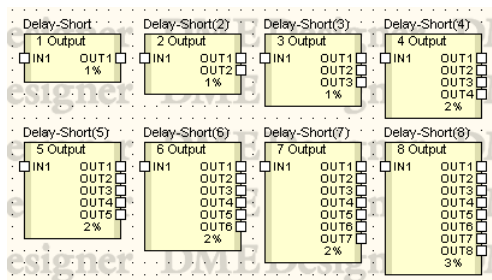

Double-click a component to display the component editor for it. Only the number of outputs in each component is different. The other parts are the same.

Delay-Short component editor



	Section	Parameter	Setting Range	Function
1	Delay	All Bypass	ON/OFF	Bypasses from input to output.
2	Input	Level	$-\infty$ to ± 0 dB	Sets the input signal level.
3		Mute	ON/OFF	Mute the input signal.

	Section	Parameter	Setting Range	Function
4	Delay Tap	Delay	ms: 0 to 130 Sample: the range depends on the Fs value. Meter: 0 to 44.7 Feet: 0 to 146.5 Frame: the range depends on the Frame value. Beat: the range depends on the Beat value.	Sets the delay time. There are two edit boxes, displaying milliseconds and the units selected for [Delay Scale].
5		Level	$-\infty$ to ± 0 dB	Sets the output signal level for each channel.
6		On	ON/OFF	Turns ON each channel's delay.
7		Mute	ON/OFF	Turns ON muting for each channel's output.
8	Delay Scale		ms Sample Meter Feet Frame Beat	Selects the units for setting the delay time. The selected button will light up, and the units in the [Delay] edit box will change. If [Beat] is selected, use the knob to set the BPM (beats/minute).

NOTE

Delay Scale does not support the parameter link feature. Refer to "Parameter Link" on [page 94](#) for information on parameter linking.

Dynamics

Components in the dynamic group adjust the dynamic range of the sound. There are eight types of components, each of which is available in mono channel and stereo channel versions. The nine types are: compander hard, compander soft, compressor, de-esser, ducking, expander, gate, limiter, and program ducker.

■ KeyIn

All components in the dynamic group, except the de-esser, have KeyIn input. This is used as a trigger source that activates the effects of the component.

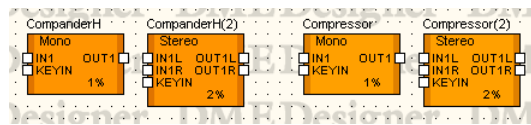

The trigger source is set in the [KeyIn] section of the component editor.



[KeyIn] Section

The currently selected trigger source is displayed on the button. Click the button and select the trigger source from the menu.

Mono channel



Stereo channel



- **[SELF]**
Sets the input signal as the trigger source for mono channel components.
- **[L]/[R]**
Sets the left or right input signal as the trigger source for stereo channel components.
- **[LR BOTH]**
Sets both the left and right input signals as the trigger source for stereo channel components. The strongest input signal will be the trigger source, whether from the left or right channel.
- **[KEYIN]**
The KeyIn input will be the trigger source.

Compander

The compander combines the effects of a compressor and an expander. A compressor compresses signals that exceed the threshold, while the expander reduces signals that fall below the threshold. There are two compander groups, CompanderH (compander hard) and CompanderS (compander soft). Within each group, there are mono channel and stereo channel companders.

Mono channel companders have one input, one output, and one KeyIn input. Stereo channel companders have two inputs, two outputs, and one KeyIn input.

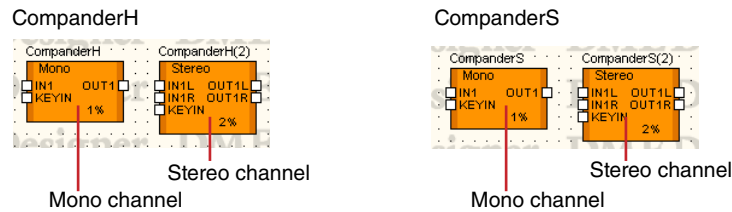

Double-click a component to display the component editor for it. The parameters are the same for mono channel and stereo channel components.

The compander hard and compander soft differ in the compression ratio of their fixed expander. The expander compression is expressed by the straight portion of the lower-left part of the compander curve. The compression ratio of the compander hard is large. The slope is also large. The compression ratio of the compander soft is small, with a gentle compression. The parameters in the component editor are the same.

CompanderH Mono component editor

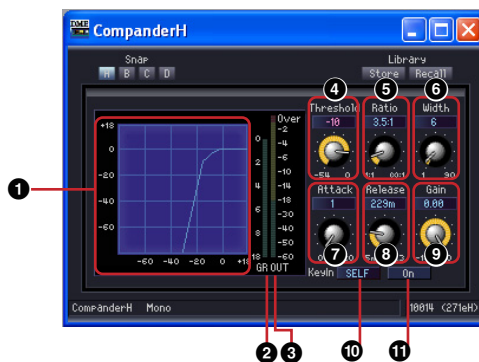

CompanderS Stereo component editor

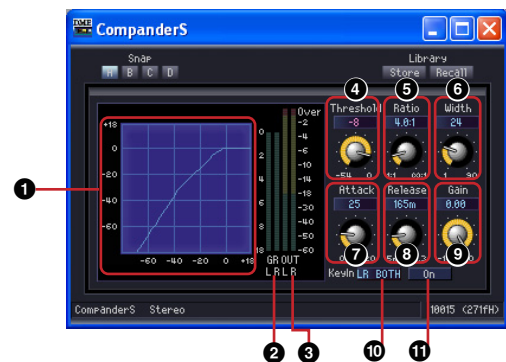

Name		Function	
1	Compander Curve	Displays results graphically. The horizontal axis is the input signal level, and the vertical axis is the output level.	
2	Gain Reduction Meter	Displays the gain reduction attenuation.	
3	Output Meter	Displays the output signal level.	
Parameter	Setting Range	Function	
4	Threshold	-54 dB to ± 0 dB	Sets the threshold value.
5	Ratio	1:1 to ∞ :1	Sets the compression ratio.
6	Width	+1 dB to +90 dB	Sets the width of the expander.
7	Attack	0 to 120 ms	Sets the attack time.
8	Release	44.1 kHz: 6 ms to 46 s 48 kHz: 5 ms to 42.3 s 88.2 kHz: 3 ms to 23 s 96 kHz: 3 ms to 21.1 s	Sets the release time. The setting range may vary, depending on the operating frequency.
9	Gain	-18 dB to ± 0 dB	Sets the output gain.

	Parameter	Setting Range		Function
10	KeyIn	Mono	SELF KEYIN	Selects the trigger source from a menu. The currently selected trigger source is displayed on the button.
		Stereo	L R LR BOTH KEYIN	
11	On	ON/OFF		Turns the compander ON.

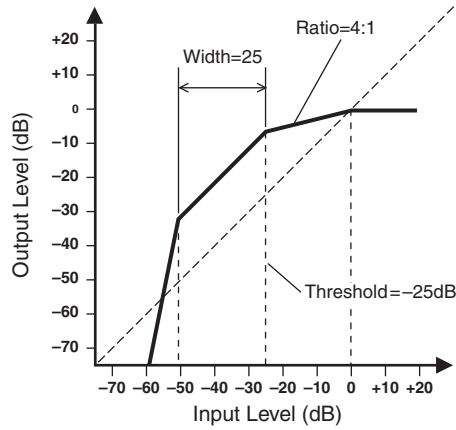

Compressor

Compresses signals that exceed a threshold. Narrows the dynamic range of the signal, making it easier to mix or record signals with a wide dynamic range such as vocals or piano music. Both mono channel and stereo channel compressors are provided.

Mono channel compressors have one input, one output, and one KeyIn input. Stereo channel compressors have two inputs, two outputs, and one KeyIn input.

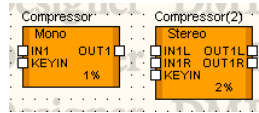

Double-click a component to open the component editor for it. The parameters are the same for mono channel and stereo channel components.

Compressor component editor

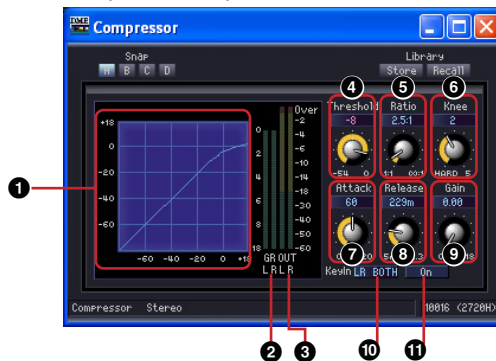

	Name	Function
1	Compressor Curve	Displays results graphically. The horizontal axis is the input signal level, and the vertical axis is the output level.
2	Gain Reduction Meter	Displays the gain reduction attenuation.
3	Output Meter	Displays the output signal level.

	Parameter	Setting Range	Function	
4	Threshold	-54 dB to ± 0 dB	Sets the threshold value.	
5	Ratio	1:1 to ∞ :1	Sets the compression ratio.	
6	Knee	HARD, 1, 2, 3, 4, 5	Sets the way compression is applied.	
7	Attack	0 to 120 ms	Sets the attack time.	
8	Release	44.1 kHz: 6 ms to 46 s 48 kHz: 5ms to 42.3 s 88.2 kHz: 3 ms to 23 s 96 kHz: 3 ms to 21.1 s	Sets the release time. The setting range may vary, depending on the operating frequency.	
9	Gain	± 0 dB to +18 dB	Sets the output gain.	
10	KeyIn	Mono Stereo	SELECTS KEYIN L R LR BOTH KEYIN	Selects the trigger source from a menu. The currently selected trigger source is displayed on the button.
11	On	ON/OFF	Turns the compressor ON.	

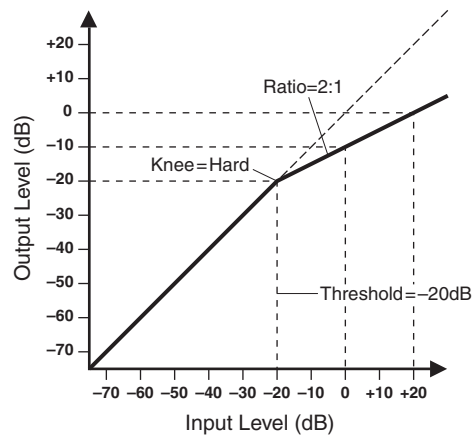

De-Esser

Compresses the signal above a specified frequency. The de-esser controls sibilant (hissing) sounds included in speech that are produced by the letter “S.” Both mono channel and stereo channel de-essers are provided.

Mono channel de-essers have one input and one output each. Stereo channel de-essers have two inputs and two outputs each.

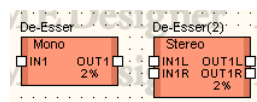

Double-click a component to open the component editor for it. The parameters are the same for mono channel and stereo channel components.



Name		Function	
1	De-Esser Curve	Displays results graphically. The horizontal axis is the input signal level, and the vertical axis is the output level.	
2	Gain Reduction Meter	Displays the gain reduction attenuation.	
3	Output Meter	Displays the output signal level.	
Parameter	Setting Range	Function	
4	Threshold	-54 dB to ± 0 dB	Sets the threshold value.
5	Ratio	1:1 to ∞ :1	Sets the compression ratio.
6	Knee	HARD, 1, 2, 3, 4, 5	Sets the way the de-esser effect is applied.
7	Attack	0 to 120 ms	Sets the attack time.
8	Release	44.1 kHz: 6 ms to 46 s 48 kHz: 5 ms to 42.3 s 88.2 kHz: 3 ms to 23 s 96 kHz: 3 ms to 21.1 s	Sets the release time. The setting range may vary, depending on the operating frequency.
9	Gain	± 0 dB to +18 dB	Sets the output gain.
10	Frequency	80 Hz to 10 kHz	Sets the minimum signal frequency for compression.
11	On	ON/OFF	Turns the de-esser ON.

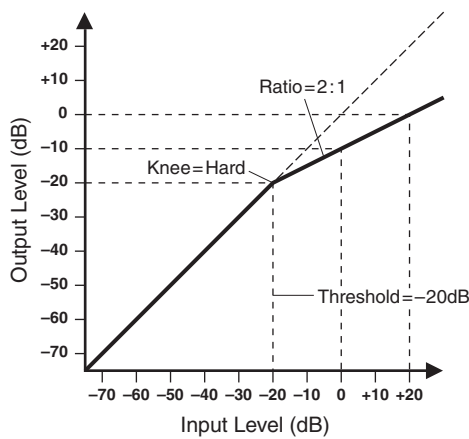

Ducking

Attenuates the output a particular amount, when an input signal exceeds its threshold. Both mono channel and stereo channel duckers are provided.

Mono channel duckers have one input, one output, and one KeyIn input. Stereo channel duckers have two inputs, two outputs, and one KeyIn input.

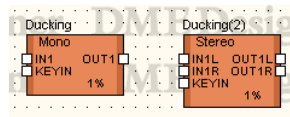

Double-click a component to open the component editor for it. The parameters are the same for mono channel and stereo channel components.

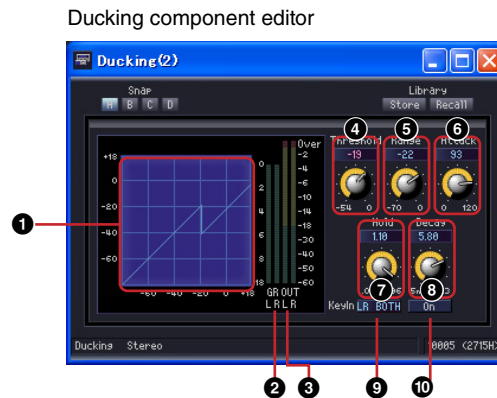

Name		Function	
1	Ducking Curve	Displays results graphically. The horizontal axis is the input signal level, and the vertical axis is the output level.	
2	Gain Reduction Meter	Displays the gain reduction attenuation.	
3	Output Meter	Displays the output signal level.	
Parameter	Setting Range	Function	
4	Threshold	-54 dB to ± 0 dB	
5	Range	-70 dB to ± 0 dB	
6	Attack	0 to 120 ms	
7	Hold	44.1 kHz: 0.02 ms to 2.13 s 48 kHz: 0.02 ms to 1.96 s 88.2 kHz: 0.01 ms to 1.06 s 96 kHz: 0.01 ms to 981 ms	
8	Decay	44.1 kHz: 6 ms to 46 s 48 kHz: 5 ms to 42.3 s 88.2 kHz: 3 ms to 23 s 96 kHz: 3 ms to 21.1 s	
9	KeyIn	Mono	SELF KEYIN
		Stereo	L R LR BOTH KEYIN
10	On	ON/OFF	
		Turns the ducking ON.	

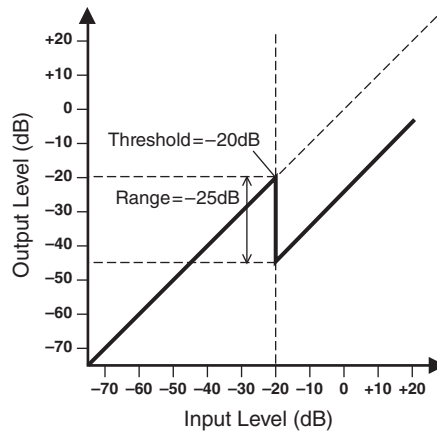

Expander

Widens the dynamic range of the signal. Low-level signals such as noise are diminished. Both mono channel and stereo channel expanders are provided. Mono channel expanders have one input, one output, and one KeyIn input. Stereo channel expanders have two inputs, two outputs, and one KeyIn input.

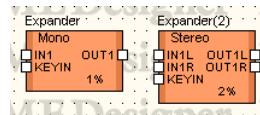

Double-click a component to open the component editor for it. The parameters are the same for mono channel and stereo channel components.

Expander component editor

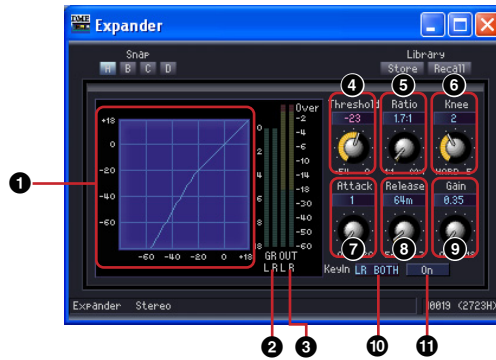

	Name	Function	
1	Expander Curve	Displays results graphically. The horizontal axis is the input signal level, and the vertical axis is the output level.	
2	Gain Reduction Meter	Displays the gain reduction attenuation.	
3	Output Meter	Displays the output signal level.	
	Parameter	Setting Range	Function
4	Threshold	-54 dB to ±0 dB	Sets the threshold value.
5	Ratio	1:1 to ∞:1	Sets the compression ratio.
6	Knee	HARD, 1, 2, 3, 4, 5	Sets the way the expander is applied.
8	Attack	0 to 120 ms	Sets the attack time.

	Parameter	Setting Range	Function	
8	Release	44.1 kHz: 6 ms to 46 s 48 kHz: 5 ms to 42.3 s 88.2 kHz: 3 ms to 23 s 96 kHz: 3 ms to 21.1 s	Sets the release time. The setting range may vary, depending on the operating frequency.	
9	Gain	±0 dB to +18 dB	Sets the output gain.	
10	KeyIn	Mono Stereo	SELF KEYIN L R LR BOTH KEYIN	Selects the trigger source from a menu. The currently selected trigger source is displayed on the button.
11	On	ON/OFF	Turns the expander ON.	

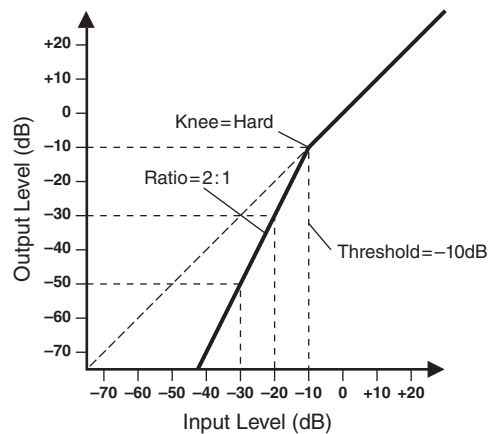

Gate

Attenuates signals that are lower than the threshold level. Both mono channel and stereo channel gates are provided.

Mono channel gates have one input, one output, and one KeyIn input. Stereo channel gates have two inputs, two outputs, and one KeyIn input.

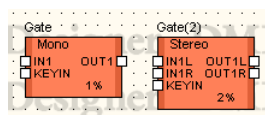

Double-click a component to open the component editor for it. The parameters are the same for mono channel and stereo channel components.

Gate component editor

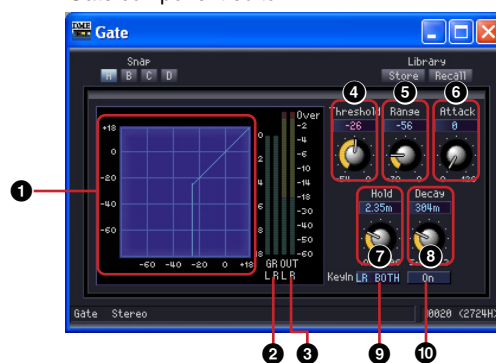

Name		Function	
1	Gate Curve	Displays results graphically. The horizontal axis is the input signal level, and the vertical axis is the output level.	
2	Gain Reduction Meter	Displays the gain reduction attenuation.	
3	Output Meter	Displays the output signal level.	
Parameter	Setting Range	Function	
4	Threshold	-54 dB to ±0 dB	
5	Range	-70 dB to ±0 dB	
6	Attack	0 to 120 ms	
7	Hold	44.1 kHz: 0.02 ms to 2.13 s 48 kHz: 0.02 ms to 1.96 s 88.2 kHz: 0.01 ms to 1.06 s 96 kHz: 0.01 ms to 981 ms	
8	Decay	44.1 kHz: 6 ms to 46 s 48 kHz: 5 ms to 42.3 s 88.2 kHz: 3 ms to 23 s 96 kHz: 3 ms to 21.1 s	
9	KeyIn	Mono	SELF KEYIN
		Stereo	L R LR BOTH KEYIN
10	On	ON/OFF	

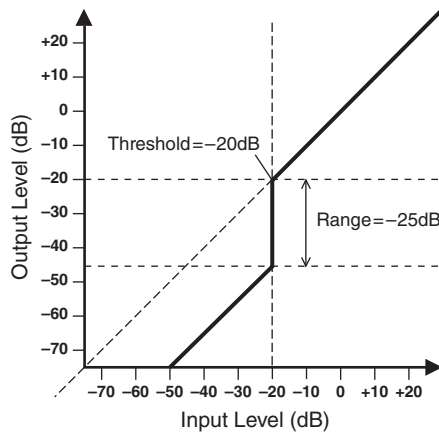

Limiter

Signals above the threshold are compressed at an ∞:1 ratio, preventing output of signals that exceed the threshold level. Mono channel and stereo channel components are provided.

Mono channel components have a single input and output plus a key input, while stereo channel components have two inputs and outputs and a key input.

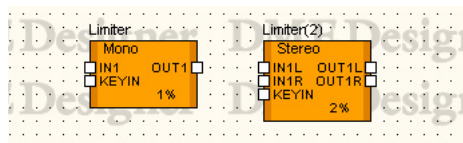

Double click the component to open the component editor. Mono channel and stereo channel components have the same parameters.

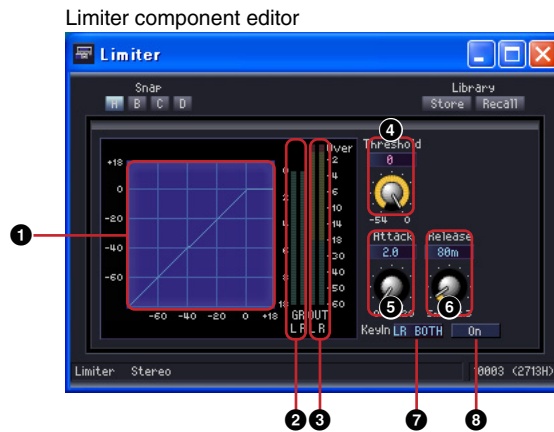

Name		Function	
1	Limiter Curve	Displays the limiter response in graph form. The horizontal axis represents input signal level and the vertical axis represents output level.	
2	Gain Reduction Meter	Displays the amount of gain reduction.	
3	Output Meter	Displays the output signal level.	
Parameter	Setting Range		Function
4	Threshold	-54 dB to ±0 dB	
5	Attack	0 to 120 ms	
6	Release	44.1 kHz: 6 ms to 46 s 48 kHz: 5 ms to 42.3 s 88.2 kHz: 3 ms to 23 s 96 kHz: 3 ms to 21.1 s	
9	KeyIn	Mono	SELF KEYIN
		Stereo	L R LR BOTH KEYIN
10	On	ON/OFF	

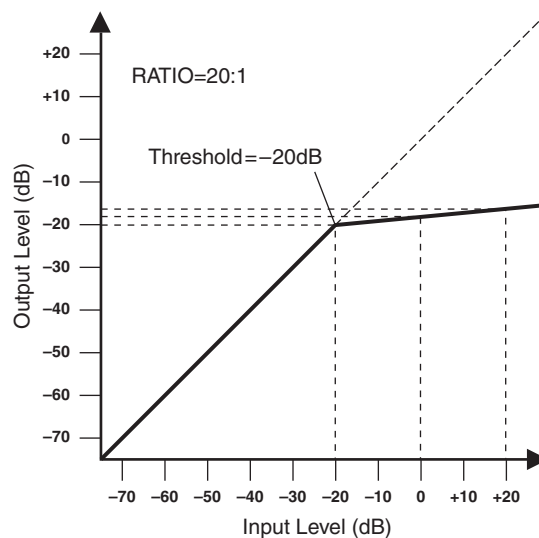

Program Ducker

When the key-in signal level exceeds the threshold level, the output signal is attenuated (or the attenuated output signal is returned to its original level).

Mono channel and stereo channel components are provided. Mono channel components have one input and one output, and a single key-in input. Stereo channel components have two inputs and two outputs, and a single key-in input.

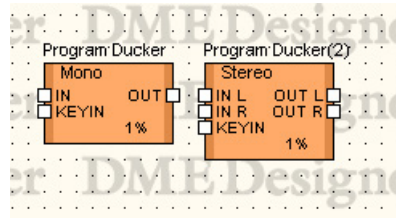

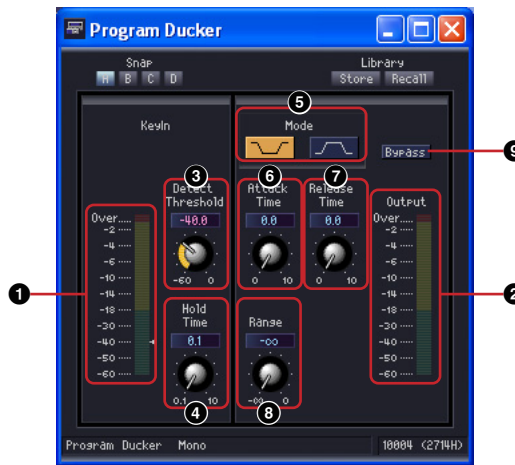

Double click the component to open the component editor. The mono and stereo channel types have the same parameters.

Program Ducker component editor



Name		Function	
1	KeyIn Meter	Displays the key-in signal level.	
2	Output Meter	Displays the output level.	
Parameter	Range	Function	
3	Detect Threshold	-60.0 – 0.0 dB	Sets the threshold level for the key-in signal. The set level is indicated by a triangular marker next to the KeyIn Meter.
4	Hold Time	0.1 – 10.0 s	Sets the hold time during which operation will continue after the key-in signal falls below the threshold level, in 0.1 second increments.
5	Mode	 : The output level is attenuated when the key-in signal is detected. The normal output level is 0dB (nominal) and the attenuated level is specified by the Range parameter. : The output level is attenuated when no key-in signal is detected, and the output returns to its original level when a key-in signal is detected. The normal attenuation level is specified by the Range parameter, and the output level when a key-in signal is detected is 0dB (nominal).	
6	Attack Time	0.0 – 10.0 s	Sets the time it takes to reach the target output level after a key-in signal is detected, in 0.1 second increments.
7	Release Time	0.0 – 10.0 s	Sets the time it takes for the output to return to its normal pre-detect level after the key-in signal falls below the threshold level and the Hold Time has elapsed, in 0.1 second increments.

Name		Function
8	Range	$-\infty - 10.0\text{ s}$ Sets the attenuation level: the attenuation level while a key-in signal is detected in the  mode, or the attenuation level while no key-in signal is detected in the  mode.
9	Bypass	On/Off Attenuation is bypassed when "On".

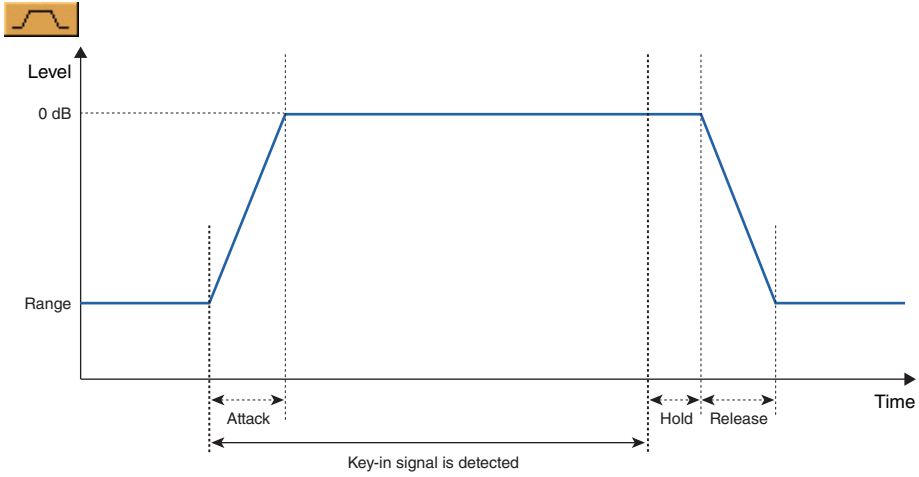
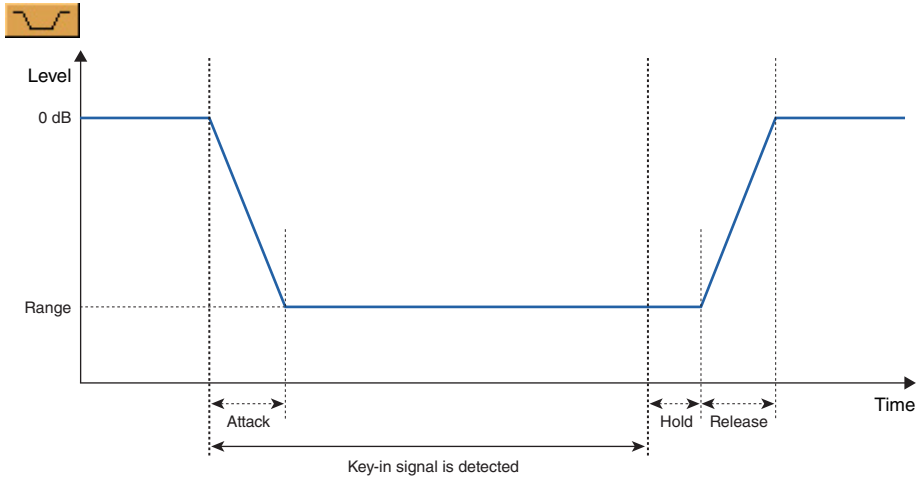

Equalizer (EQ)

The equalizer boosts or cuts the levels of specified frequencies. The EQ group contains graphic equalizers (GEQ) and parametric equalizers (PEQ).

The frequency bands in the graphic equalizer are fixed. The graphical interface lets you visually check the gain of each frequency. There are three different types of equalizers, each with a different number of frequency bands. Mono channel and stereo channel equalizers are available for each type.

With the parametric equalizer, you can freely adjust the frequency bands, their amplitudes, and bandwidths. There are six different types of parametric equalizers, each with a different number of frequency bands. Mono channel and stereo channel equalizers are available for each type.

Graphic Equalizer (GEQ)

Boosts or cuts signals within the specified frequencies. The mono group contains 7 band, 15 band, and 31 band mono channel components. The stereo group contains 7 band, 15 band, and 31 band stereo channel components.

Mono channel GEQs have one input and one output each. Stereo channel GEQs have two inputs and two outputs each.

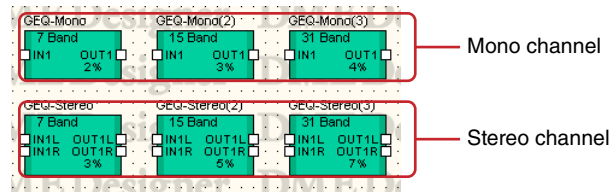

Double-click a component to display the component editor for it. The number of bands varies depending on the component, but all share a common configuration in the component editor.

Component editor for GEQ

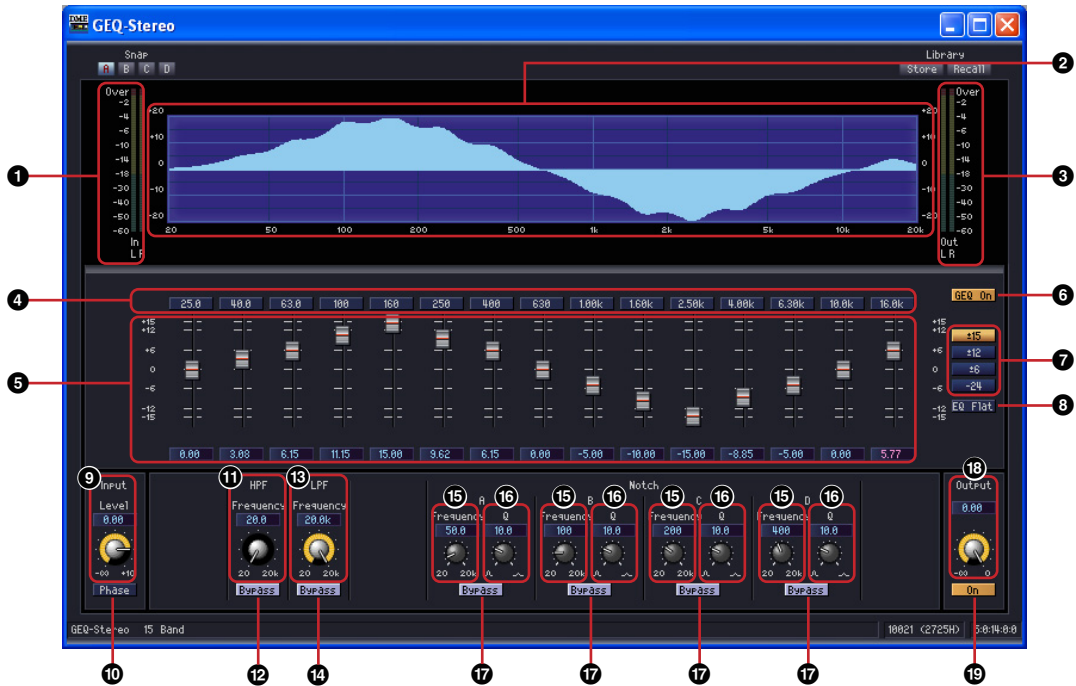

	Name	Function
1	Input Meter	Displays the input signal level.
2	EQ Curve	Displays the equalizer effect.
3	Output Meter	Displays the output signal level.

	Section	Parameter	Setting Range	Function
4	Equalizer	Bypass	ON/OFF	Turns ON bypass for each band.
5		Gain	Set by [Range].	Sets the output gain for its band.
6		GEQ ON	ON/OFF	Turns the GEQ ON.
7		Range	± 15 ± 12 ± 6 -24	Selects the gain adjust width.
8		EQ Flat	--	Returns the faders of all bands to 0dB.
9	Input	Level	$-\infty$ to +10 dB	Sets the input signal level.
10		Phase	ON/OFF	Reverses the phase of the input signal.
11	HPF	Frequency	20 Hz to 20 kHz	Sets the HPF cutoff frequency.
12		Bypass	ON/OFF	Turns bypass ON.
13	LPF	Frequency	20 Hz to 20 kHz	Sets the LPF cutoff frequency.
14		Bypass	ON/OFF	Turns bypass ON.
15	Notch	Frequency	20 Hz to 20 kHz	Sets the notch filter frequency.
16		Q:	0.1 to 63.0	Sets the width of the frequency band that will be changed by the filter.
17		Bypass	ON/OFF	Turns bypass ON.
18	Output	Level	$-\infty$ to ± 0 dB	Sets the signal level.
19		On	ON/OFF	Turns output ON.

■ EQ Graph [Bypass] Button

A number for each frequency band is displayed on these buttons. When you click the button, it lights up and the bypass turns ON. When you turn this ON, bypassed sound (unchanged sound) is output. When you turn this OFF, the sound is output with effects applied.



Bypass ON



Bypass OFF

Parametric Equalizer (PEQ)

Boosts or cuts signals within specified frequencies. In both the Mono group and Stereo group there are 2 band, 3 band, 4 band, 6 band, and 8 band components available. Mono channel PEQs have one input and one output each. Stereo channel PEQs have two inputs and two outputs each. The number of bands varies depending on the component, but all share a common configuration in the component editor.

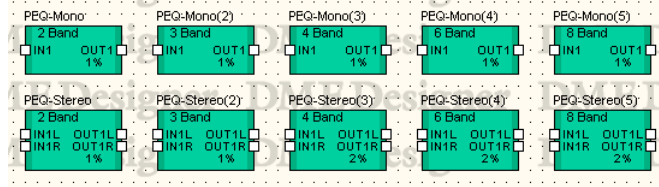

Double-click a component to display the component editor for it. The number of bands varies depending on the component, but all share a common configuration in the component editor.

PEQ component editor



		Name	Function	
1	EQ Curve	Displays the equalizer effect. You can change the parameter by dragging the control point with the mouse.		
2	Input	Level	-∞ to +10 dB	Sets the input signal level.
		Phase	ON/OFF	Reverses the phase of the input signal.
4	Equalizer	Type	PEQ L.SHELF 6 dB/Oct L.SHELF 12 dB/Oct H.SHELF 6 dB/Oct H.SHELF 12 dB/Oct HPF LPF	Select the filter type from the menu.
		Q	0.1 to 16.0	Sets the band width for each frequency band.
		Frequency	20 Hz to 20 kHz	Sets the frequency for each band.
		Gain	-18 dB to +18 dB	Sets the level of the frequency that will be changed.
8	Bypass	ON/OFF	Turns ON bypass for each band.	

	Section	Parameter	Setting Range	Function
9	Equalizer	PEQ ON	ON/OFF	Turns the PEQ ON
10	Output	Level	$-\infty$ to ± 0 dB	Sets the output signal level.
11		On	ON/OFF	Turns output ON.

■ Filter Type

Various types of curves are available for changing the level. Click the [Type] button and select the type from the menu.

- **PEQ**
This is a general parametric equalizer.
- **L. SHELF (Low Shelving)**
There is no sound attenuation at low frequencies. The sound is attenuated at a constant rate from the cutoff frequency towards the higher frequencies. The attenuation rate per octave can be set to [6 dB/Oct] or [12 dB/Oct].
- **H.SHELF (High Shelving)**
There is no sound attenuation at high frequencies. The sound is attenuated at a constant rate from the cutoff frequency towards the lower frequencies. The attenuation rate per octave can be set to [6 dB/Oct] or [12 dB/Oct].
- **HPF**
This is a high-pass filter (Q=0.7). Attenuates the low frequencies with a gentle curve (12 dB/Oct).
- **LPF**
This is a low-pass filter (Q=0.7). Attenuates the high frequencies with a gentle curve (12 dB/Oct).

Fader

Controls the output level for each channel. Fader components are available for 1, 2, 4, 8, 12, and 16 channels.

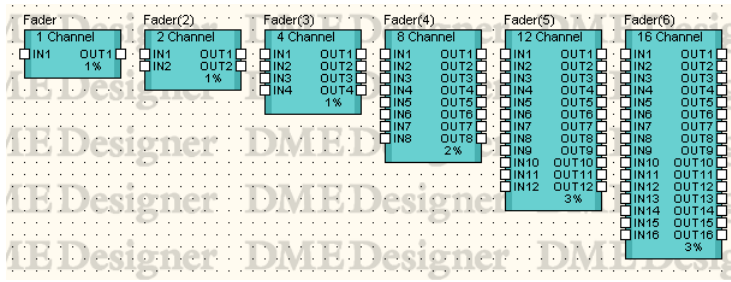

Double-click a component to display the component editor for it. The number of channels varies, but all components share a common configuration in the component editor.

Fader component editor

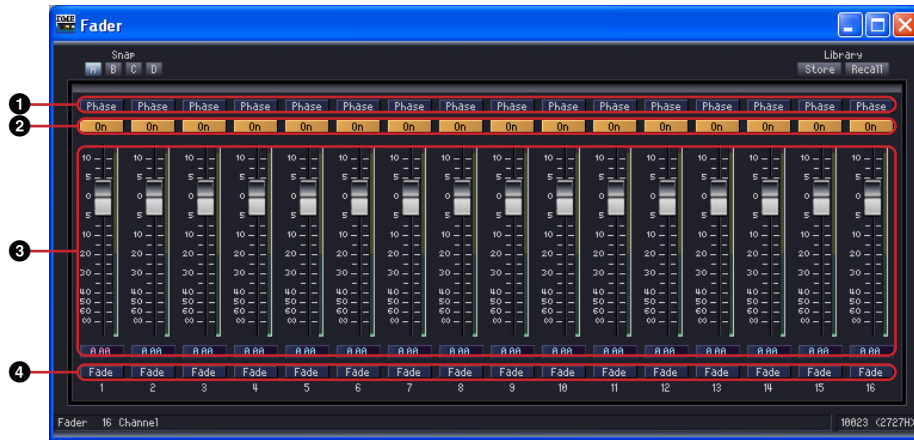

	Parameter	Setting Range	Function
1	Phase	ON/OFF	Reverses the phase of the output signal for each channel.
2	On	ON/OFF	Turns ON each channel's output.
3	Fader	$-\infty$ to +10 dB	Sets the output signal level for each channel.
4	Fade	ON/OFF	Sets fade during scene recall ON or OFF.

■ [Fade]

Sets the action of the fader when there is a large change in its position during scene recall. When you turn this ON, the fader moves gradually to the position after the jump. If you turn this OFF, it immediately jumps to the parameters saved in the recalled scene.

See “The ‘Scene Manager’ Dialog Box” (page 82) for details about settings for the components to be faded and the time period when the [Fade] is On.

Feedback Suppressor

The Feedback Suppressor effectively suppresses acoustic feedback.



	Parameter	Setting Range	Function
1	Mode	Speech Select this mode when the input source is speech. Music Select this mode when the input source is music.	Selects the type of input signal to be processed.
2	Suppression Level	0 ~ 9	Sets the degree of feedback suppression. Higher values produce greater feedback reduction. Further, the amount of pitch changed produced by the effect is displayed in cents.
3	Bypass	ON/OFF	Turns bypass on.

Filters

A filter passes specific frequencies and attenuates all others.

There are seven types of filters available in the filter group: band pass filter (BPF), high pass filter (HPF), low pass filter (LPF), notch filter (Notch), programmable BPF, programmable HPF, and programmable LPF.

Band Pass Filter (BPF)

The band pass filter passes the signal from a specified frequency band, while attenuating frequencies outside that band. There are two types of BPF components: mono channel and stereo channel. Mono channel BPFs have one input and one output. Stereo channel BPFs have two of each.

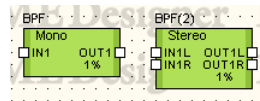

Double-click a component to display the component editor for it. The parameters are the same for mono channel and stereo channel components.

BPF component editor



	Section	Parameter	Setting Range	Function
1	Input	Level	$-\infty$ to +10 dB	Sets the input signal level.
2		Phase	ON/OFF	Reverses the phase of the input signal.
3	BPF	Frequency	20 Hz to 20 kHz	Sets the center frequency.
4		Q:	0.1 to 16.0	Sets the band width of a frequency band.
5		Bypass	ON/OFF	Turns bypass ON.
6	Output	Level	$-\infty$ to ± 0 dB	Sets the output signal level.

High Pass Filter (HPF)

The high pass filter passes frequencies in the signal that are higher than a specified frequency, while attenuating lower frequencies in the signal. There are two types of HPF components: mono channel and stereo channel. Mono channel HPFs have one input and one output. Stereo channel HPFs have two of each.

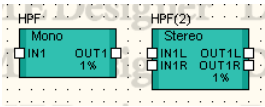

Double-click a component to display the component editor for it. The parameters are the same for mono channel and stereo channel components.



	Section	Parameter	Setting Range	Function
1	Input	Level	-∞ to +10 dB	Sets the input signal level.
2		Phase	ON/OFF	Reverses the phase of the input signal.
3	HPF	Frequency	20 Hz to 20 kHz	Sets the cutoff frequency.
4		Slope	6 dB/Oct 12 dB/Oct	Sets the attenuation for each octave.
5		Bypass	ON/OFF	Turns bypass ON.
6	Output	Level	-∞ to ±0 dB	Sets the output signal level.

Low Pass Filter (LPF)

The low pass filter passes frequencies in the signal that are lower than a specified frequency, while attenuating higher frequencies in the signal. There are two types of LPF components: mono channel and stereo channel. Mono channel LPFs have one input and one output. Stereo channel LPFs have two of each.

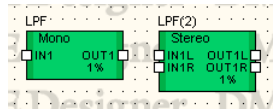

Double-click a component to display the component editor for it. The parameters are the same for mono channel and stereo channel components.

LPF component editor



	Section	Parameter	Setting Range	Function
1	Input	Level	-∞ to +10 dB	Sets the input signal level.
2		Phase	ON/OFF	Reverses the phase of the input signal.
3	LPF	Frequency	20 Hz to 20 kHz	Sets the cutoff frequency.
4		Slope	6 dB/Oct 12 dB/Oct	Sets the attenuation for each octave.
5		Bypass	ON/OFF	Turns bypass ON.
6	Output	Level	-∞ to ±0 dB	Sets the output signal level.

Notch Filter (Notch)

The notch filter attenuates the signal within a specified frequency band, while passing frequencies outside that band. There are two types of notch filter components: mono channel and stereo channel. Mono channel notch filters have one input and one output. Stereo channel notch filters have two of each.

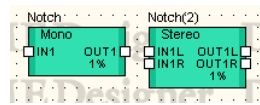

Double-click a component to display the component editor for it. The parameters are the same for mono channel and stereo channel components.

Notch component editor



	Section	Parameter	Setting Range	Function
1	Input	Level	$-\infty$ to +10 dB	Sets the input signal level.
2		Phase	ON/OFF	Reverses the phase of the input signal.
3	Notch	Frequency	20 Hz to 20 kHz	Sets the center frequency.
4		Q:	0.1 to 63.0	Sets the band width of the frequency band that will be changed
5		Bypass	ON/OFF	Turns bypass ON.
6	Output	Level	$-\infty$ to ± 0 dB	Sets the output signal level.

Programmable BPF

The band pass filter passes the signal from a specified frequency band, while attenuating frequencies outside that band. With the programmable band pass filter you can set the filter type and the slope between the frequency band that is passed and the band that is cutoff.

There are two types of programmable BPF components: mono channel and stereo channel. Mono channel programmable BPFs have one input and one output. Stereo channel programmable BPFs have two of each.

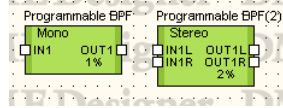

Double-click a component to display the component editor for it. The parameters are the same for mono channel and stereo channel components.

Programmable BPF component editor

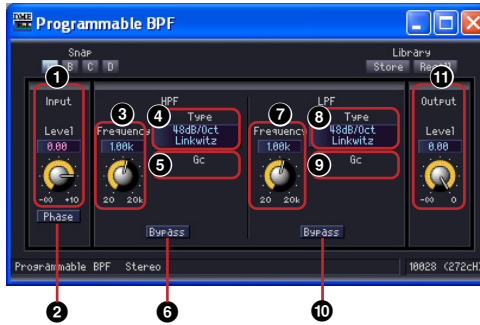

	Section	Parameter	Setting Range	Function
1	Input	Level	$-\infty$ to +10 dB	Sets the input signal level.
2		Phase	ON/OFF	Reverses the phase of the input signal.
3	HPF	Frequency	20 Hz to 20 kHz	Sets the HPF cutoff frequency.
4		Type	Thru 6 dB/Oct 12 dB/Oct AdjustGc 12 dB/Oct Butwrth 12 dB/Oct Bessel 12 dB/Oct Linkwitz 18 dB/Oct AdjustGc 18 dB/Oct Butwrth 18 dB/Oct Bessel 24 dB/Oct AdjustGc 24 dB/Oct Butwrth 24 dB/Oct Bessel 24 dB/Oct Linkwitz 36 dB/Oct AdjustGc 36 dB/Oct Butwrth 36 dB/Oct Bessel 48 dB/Oct AdjustGc 48 dB/Oct Butwrth 48 dB/Oct Bessel 48 dB/Oct Linkwitz	Sets the attenuation for each octave and the filter type. [THRU] turns off the filter.
5		Gc	-6 dB to +6 dB	When [AdjustGc] (Adjustable Gc) is selected for [Type], this sets the gain for the cutoff frequency.
6		Bypass	ON/OFF	Turns bypass ON.

	Section	Parameter	Setting Range	Function
7	LPF	Frequency	20 Hz to 20 kHz	Sets the LPF cutoff frequency.
8		Type	Thru 6 dB/Oct AdjustGc 12 dB/Oct AdjustGc 12 dB/Oct Butwrth 12 dB/Oct Bessel 12 dB/Oct Linkwitz 18 dB/Oct AdjustGc 18 dB/Oct Butwrth 18 dB/Oct Bessel 24 dB/Oct AdjustGc 24 dB/Oct Butwrth 24 dB/Oct Bessel 24 dB/Oct Linkwitz 36 dB/Oct AdjustGc 36 dB/Oct Butwrth 36 dB/Oct Bessel 48 dB/Oct AdjustGc 48 dB/Oct Butwrth 48 dB/Oct Bessel 48 dB/Oct Linkwitz	Sets the attenuation for each octave and the filter type. [THRU] turns off the filter.
9		Gc	-6 dB to +6 dB	When [AdjustGc] (Adjustable Gc) is selected for [Type], this sets the gain for the cutoff frequency.
10		Bypass	ON/OFF	Turns bypass ON.
11	Output	Level	$-\infty$ to ± 0 dB	Sets the output signal level.

Programmable HPF

The high pass filter passes frequencies in the signal that are higher the specified frequency, while attenuating lower frequencies in the signal. With the programmable high pass filter you can set the filter type and the slope between the frequency band that is passed and the band that is cutoff. There are two types of programmable HPF components: mono channel and stereo channel. Mono channel programmable HPFs have one input and one output. Stereo channel programmable HPFs have two of each.

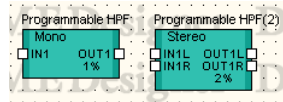

Double-click a component to display the component editor for it. The parameters are the same for mono channel and stereo channel components.

Programmable HPF component editors

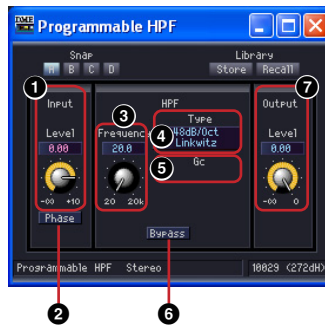

	Section	Parameter	Setting Range	Function
1	Input	Level	$-\infty$ to +10 dB	Sets the input signal level.
2		Phase	ON/OFF	Reverses the phase of the input signal.
3	HPF	Frequency	20 Hz to 20 kHz	Sets the HPF cutoff frequency.
5		Type	Thru 6 dB/Oct 12 dB/Oct AdjustGc 12 dB/Oct Butwrth 12 dB/Oct Bessel 12 dB/Oct Linkwitz 18 dB/Oct AdjustGc 18 dB/Oct Butwrth 18 dB/Oct Bessel 24 dB/Oct AdjustGc 24 dB/Oct Butwrth 24 dB/Oct Bessel 24 dB/Oct Linkwitz 36 dB/Oct AdjustGc 36 dB/Oct Butwrth 36 dB/Oct Bessel 48 dB/Oct AdjustGc 48 dB/Oct Butwrth 48 dB/Oct Bessel 48 dB/Oct Linkwitz	Sets the attenuation for each octave and the filter type. [THRU] turns off the filter.
6		Gc	-6 dB to +6 dB	When [AdjustGc] (Adjustable Gc) is selected for [Type], this sets the gain for the cutoff frequency.
7		Bypass	ON/OFF	Turns bypass ON.
8	Output	Level	$-\infty$ to ± 0 dB	Sets the output signal level.

Programmable LPF

The low pass filter passes frequencies in the signal that are lower than the specified frequency, while attenuating higher frequencies in the signal. With the programmable low pass filter you can set the filter type and the slope between the frequency band that is passed and the band that is cutoff. There are two types of programmable LPF components: mono channel and stereo channel. Mono channel programmable LPFs have one input and one output. Stereo channel programmable LPFs have two of each.

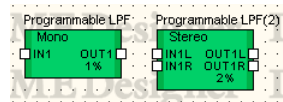

Double-click a component to display the component editor for it. The parameters are the same for mono channel and stereo channel components.

Programmable LPF component editor



	Section	Parameter	Setting Range	Function
1	Input	Level	$-\infty$ to +10 dB	Sets the input signal level.
2		Phase	ON/OFF	Reverses the phase of the input signal.
3	LPF	Frequency	20 Hz to 20 kHz	Sets the LPF cutoff frequency.
5		Type	Thru 6 dB/Oct 12 dB/Oct AdjustGc 12 dB/Oct Butwrth 12 dB/Oct Bessel 12 dB/Oct Linkwitz 18 dB/Oct AdjustGc 18 dB/Oct Butwrth 18 dB/Oct Bessel 24 dB/Oct AdjustGc 24 dB/Oct Butwrth 24 dB/Oct Bessel 24 dB/Oct Linkwitz 36 dB/Oct AdjustGc 36 dB/Oct Butwrth 36 dB/Oct Bessel 48 dB/Oct AdjustGc 48 dB/Oct Butwrth 48 dB/Oct Bessel 48 dB/Oct Linkwitz	Sets the attenuation for each octave and the filter type. [THRU] turns off the filter.
6		Gc	-6 dB to +6 dB	When [AdjustGc] (Adjustable Gc) is selected for [Type], this sets the gain for the cutoff frequency.
7		Bypass	ON/OFF	Turns bypass ON.
8	Output	Level	$-\infty$ to ± 0 dB	Sets the output signal level.

Meter

Displays signal levels. Meter components are available with 1, 2, 4, 8, 12, and 16 channels.

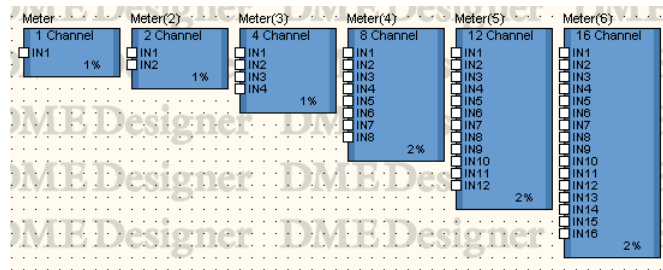

Double-click a component to display the component editor for it. The number of channels varies depending on the component, but all share a common configuration in the component editor.

Meter component editor

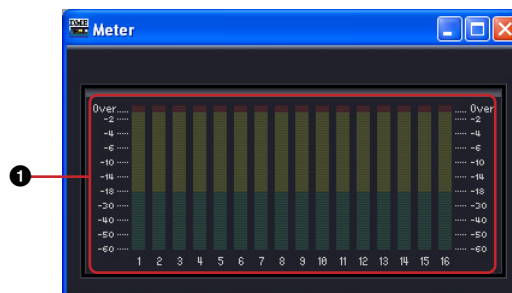

	Name	Function
1	Meter	Displays signal levels for each channel.

Miscellaneous

In the Miscellaneous group, there are the Oscillator subgroup and the Wav File Player.

Oscillator

The Oscillator subgroup contains a monochannel oscillator component. The oscillator generates sine waves at fixed frequencies of 100 Hz, 1 kHz, and 10 kHz, a variable frequency sine wave, pink noise, and burst noise.

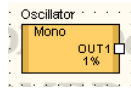

Double-click a component to display the component editor for it.

Oscillator component editor



	Section	Parameter	Setting Range	Function
1	Wave Form	Sine	100 Hz 1 kHz 10 kHz Vari	Selects the frequency and waveform that will be generated. Only one of the six [Sine] and [Noise] buttons can be selected.
2		Noise	Pink Burst	
3		Frequency	20 Hz to 20 kHz	
4	Output	Level	-∞ to +6 dB	Displays the signal level.
5		On	ON/OFF	Turns ON the oscillator.
6		Meter	--	Displays the output signal level.

Pink Noise

A standard signal used for sound measurement.

This sound covers a frequency range of 20 Hz to 20 kHz. As the frequency doubles, the energy of the sound is cut in half. The sound level is equal at all frequencies.

Burst

Outputs pink noise Outputs a pink noise burst signal.

Wav File Player

The Wav File Player is a component for playing Wave files. Only one Wav File Player component can be arranged for each single DME unit.
 Add Wave files via the Wav File Manager (page 108).

NOTE
 If you switch the effect type for SPX components while playing Wave file by Wav File Player, drop-outs in the sound played in the Wav File Player may occur.

NOTE
 When a Wave file is played back while the DME is set to operate at 88.2 kHz or 96 kHz, only the OUT1 output of the Wav File Player will be delivered via the Left channel. There will be no output from OUT2.

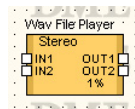

Double-click the component to display the component editor for it.

Wav File Player component editor

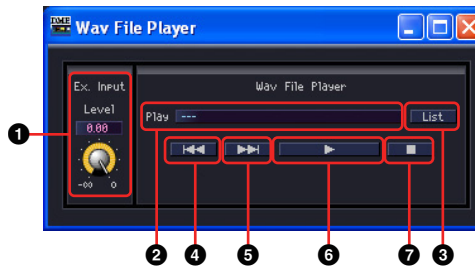

	Section	Parameter	Setting Range	Function
1	Ex. Input	Level	-∞ to 0 dB	Sets the input level from an input port. Only effective when “External Input” is selected as the playback file.
2	Wav File Player	Play	001 to 100	Selects and displays the playback file. Only files set in the DME unit in which this component is placed by the Wav File Manager can be selected.
3		List	--	Open the Wav File Manager to display a list of files set in the DME unit in which this component is located. This list functions as a play list.
4		⏮	--	Selects the previous file in the play list.
5		⏭	--	Selects the next file in the playsuit.
6		▶	--	Plays the selected Wave file. Mute is turned OFF when “External Input” is selected.
7		■	--	Stops playback of the Wave file. Muted when “External Input” is selected.

NOTE
 Playback will be stopped if synchronization is carried out during playback.

Mixer

The Mixer group contains the Auto Mixer, Auto Mixer II, Delay Matrix, Matrix Mixer, and Simple Mixer.

Auto Mixer

There is a noise gate for each input channel, which passes only signals that exceed a specified threshold. There are five mixer types, each with a different number of inputs.

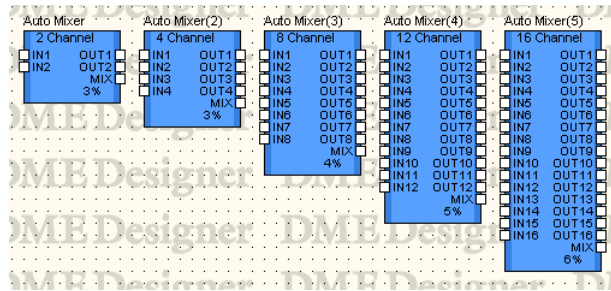

Double-click a component to display the component editor for it. The number of channels varies depending on the component, but all share a common configuration in the component editor. The auto mixer component editor consists of two sections: input channels and master output.

Auto Mixer component editor

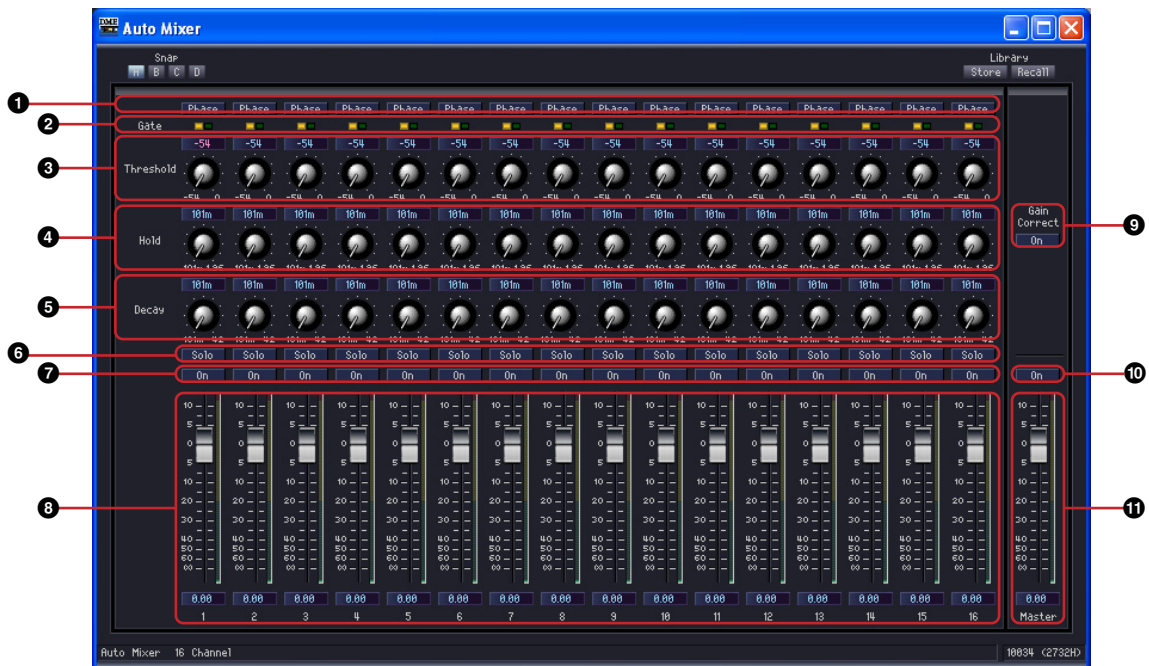

	Section	Parameter	Setting Range	Function
1	Input Channels	Phase	ON/OFF	Reverses the phase of each channel's input signal.
2		Gate Indicator	--	When the gate is open, the light turns green. When the gate is closed, the light turns yellow.
3		Threshold	-54 dB to ± 0 dB	Sets the threshold value for each gate.
4		Hold	44.1 kHz: 110 ms to 2.13 s 48 kHz: 101 ms to 1.96 s 88.2 kHz: 55.1 ms to 1.06 s 96 kHz: 50.6 ms to 981 m	Sets the gate hold time. The setting range may vary, depending on the operating frequency.

	Section	Parameter	Setting Range	Function
5		Decay	44.1 kHz: 110 ms to 46 s 48 kHz: 101 ms to 42.3 s 88.2 kHz: 55 ms to 23 s 96 kHz: 51 ms to 21.1 s	Sets the speed for closing the gate. The setting range may vary, depending on the operating frequency.
6		Solo	ON/OFF	Turns solo ON. If Solo is engaged for even one channel, all non-Solo channels will be muted.
7		On	ON/OFF	Turns ON each channel's input.
8		Fader	$-\infty$ to +10 dB	Sets the input signal level for each channel.
9	Master Output	Gain Correct	ON/OFF	Automatically adjusts the master output level to maintain a constant level according to the number of input channels with open gates. (*1)
10		On	ON/OFF	Turns ON each channel's output.
11		Master	$-\infty$ to +10 dB	Sets the output signal level.

*1 The amount of gain compensation varies according to the number of input channels with open gates as follows:

Number of channels with open gates	Amount of gain compensation
0	0.0 dB
1	0.0 dB
2	-3.0 dB
3	-4.8 dB
4	-6.0 dB
5	-7.0 dB
6	-7.8 dB
7	-8.5 dB
8	-9.0 dB
9	-9.5 dB
10	-10.0 dB
11	-10.4 dB
12	-10.8 dB
13	-11.1 dB
14	-11.5 dB
15	-11.8 dB
16	-12.0 dB

Auto Mixer II

This component detects the presence of signals at the input channels, and automatically adjusts the master output level to maintain a constant level according to the number of active input channels. 8-input and 16-input types are provided.

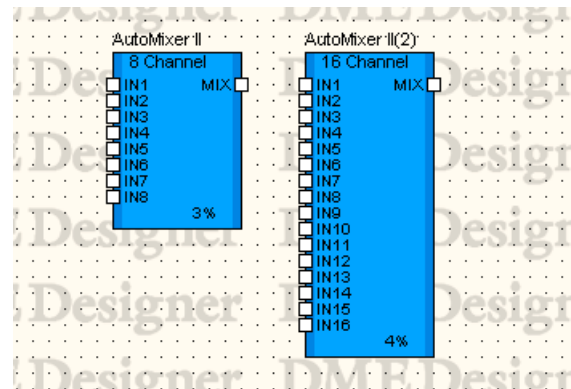

Double-click the component to open the component editor. The component editor is the same for the 8-input and 16-input types, the only difference being the number of channels. The Auto Mixer II component editor is organized into input channel and master output sections.

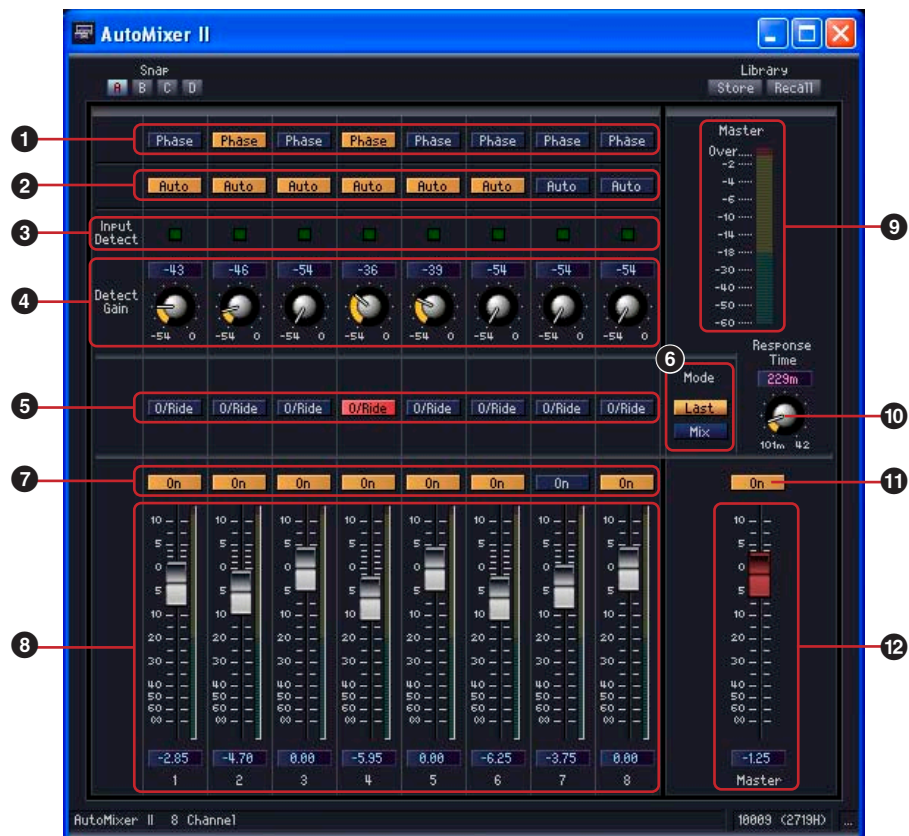

	Section	Parameter	Setting Range	Function
1	Input Channel	Phase	ON/OFF	Inverts the phase of each input channel.
2		Auto	ON/OFF	Specifies whether each channel is applied to automatic compensation or not.
3		Input Detect		Lights when the input level exceeds the Detect Gain setting.
4		Detect Gain	-54 to 0 dB	Sets the threshold level above which input signals will be detected. The master output level is automatically adjusted (reduced) to maintain a constant level according to the number of channels for which input is detected. (*1)
5		O/Ride	ON/OFF	The corresponding channel is given output priority when this parameter is ON. All other channels are muted.
6		Mode	Last/Mix	Determines whether only the last channel given priority via the O/Ride parameter is turned ON (Last), or whether multiple channels can be turned ON (Mix).
7		On	ON/OFF	Turns the input to each channel ON.
8		Fader	$-\infty$ to +10 dB	Sets the input level for each input channel.
9	Master Output	Level Meter		Displays the master output level.
10		Response Time	*2	Sets the response time for reducing the amount of output level compensation (gain increase).
11		On	ON/OFF	Turns the master output ON.
12		Fader	$-\infty$ to +10 dB	Sets the master output level.

*1 The amount of gain compensation varies according to the number of channels for which input is detected as follows:

Number of detected input channels	Amount of gain compensation
0	0.0 dB
1	0.0 dB
2	-3.0 dB
3	-4.8 dB
4	-6.0 dB
5	-7.0 dB
6	-7.8 dB
7	-8.5 dB
8	-9.0 dB
9	-9.5 dB
10	-10.0 dB
11	-10.4 dB
12	-10.8 dB
13	-11.1 dB
14	-11.5 dB
15	-11.8 dB
16	-12.0 dB

*2 The setting range of Response Time varies according to the operating frequency as follows:

44.1kHz: 110 msec to 46.0 sec, 48kHz: 101 msec to 42.3 sec, 88.2kHz: 55 msec to 23.0sec, 96kHz: 51 msec to 21.1 sec

Delay Matrix

This is a matrix mixer that allows you to set an independent delay time and level adjustment for each output. There are three groups of delay matrix, based on the number of inputs: 2 Input, 4 Input, and 8 Input. In each of the three groups there are five mixers available with 2, 4, 8, 12, or 16 outputs, for a total of 15 components.

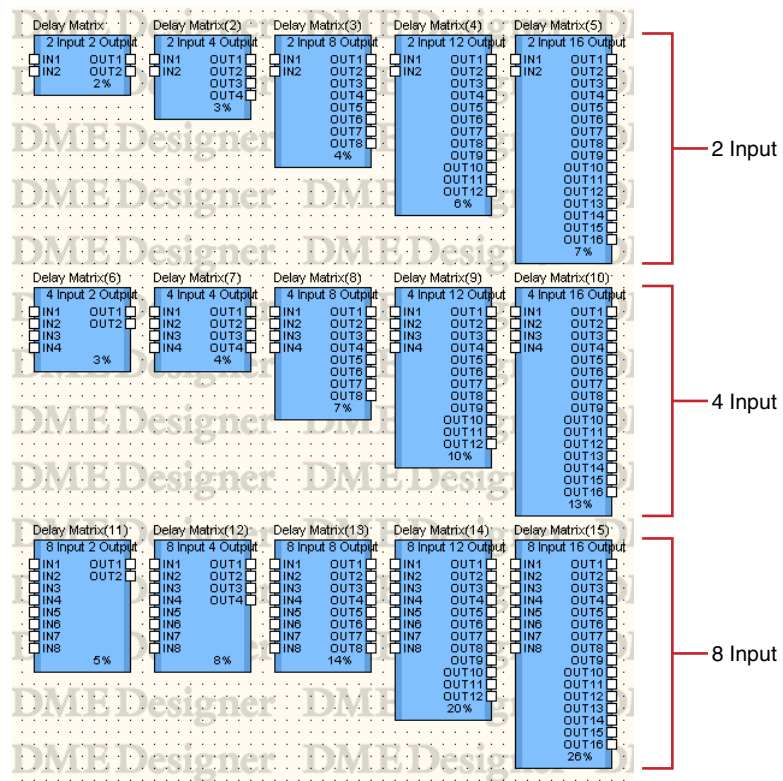

Double-click a component to display the component editor for it. The number of input and output channels varies depending on the component, but all share a common configuration in the component editor.

The delay matrix component editor consists of four sections: input, output, matrix, and block. The [Master] buttons in the [Input] and [Output] sections display windows where you can make master input and output settings. Delay and level for each channel are set in separate windows that display four channels each.

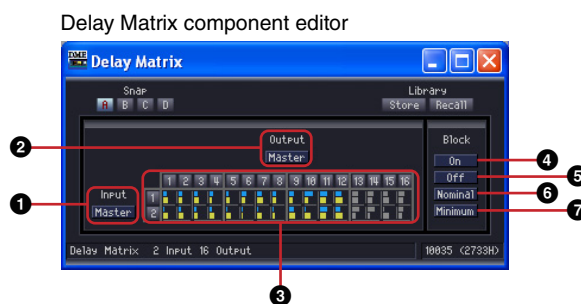

	Section	Name	Function
❶	Input	Master	Opens the Input Master window.
❷	Output	Master	Opens the Output Master window.
❸	Matrix	Delay meters Send level meters	Displays send level and delay time from each input channels to output buses. Clicking here displays the Crosspoint window.

	Section	Name	Function
4	Block	On	Turns ON send from all input channels to output buses. The [ON] button lights up.
5		Off	Turns OFF send from all input channels to output buses.
6		Nominal	Resets all send levels, making them 0 dB. The delay settings are not changed.
7		Minimum	Resets all send levels, making them $-\infty$ dB. The delay settings are not changed.

Matrix (Delay Meter/Output Level Meter)

The upper row has delay meters, while the middle row has send level meters. You can view parameters for all output channels at once.



When you click the output channel number on the matrix, the [Delay Matrix - All Inputs to One Output] editor window opens. When you click the input channel number on the left side of the matrix, the [Delay Matrix - One Input to All Outputs] editor window opens.

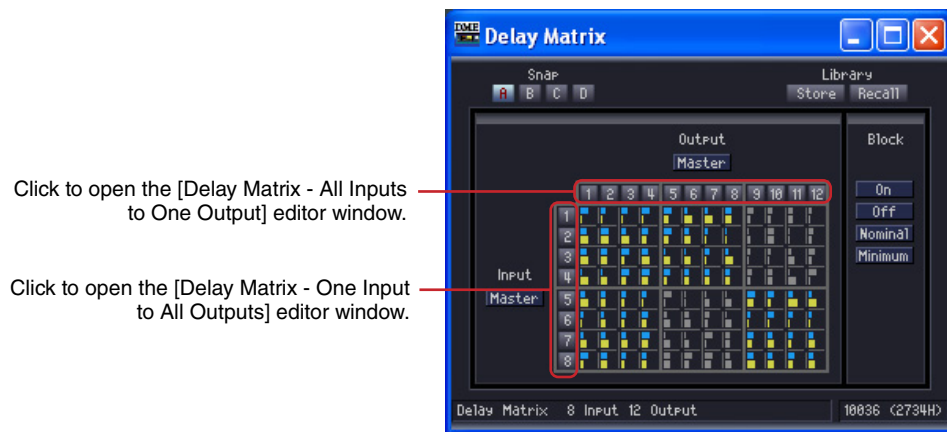

The matrix is divided into groups. For the 2 Input matrix, each group has two input channels and four output channels. For the 4 Input matrix, each group has four input channels and four output channels. Groups in matrixes with more than four inputs are the same as for the 4 Input matrix. When you place the mouse pointer over a group, its channel numbers are highlighted. Click to open the [Delay Matrix - Crosspoint] editor window.

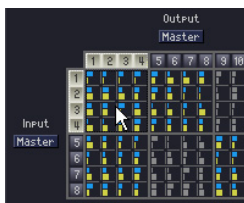

Click to open the "In 1-4 x Out 1-4" Crosspoint window.

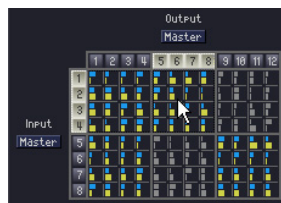

Click to open the "In 5-8 x Out 5-8" Crosspoint window.

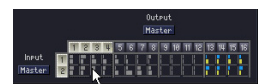

For 2 input matrix, click to open the "In 1-2 x Out 1-4" Crosspoint window.

Input Master

If you click the [Input Master] button in the delay matrix component editor, it will open the [Delay Matrix - InputMaster] editor window. Here you can turn the master input for each channel ON and OFF and set the level.

[Delay Matrix - InputMaster] editor window



	Section	Parameter	Setting Range	Function
1	Input	Phase	ON/OFF	Reverses the phase of each channel's signal.
2		Level	$-\infty$ to +10 dB	Sets the level of the signal from each channel's input.
3		Solo	ON/OFF	Turns ON solo for each channel. If Solo is engaged for even one channel, all non-Solo channels will be muted.
4		On	ON/OFF	Turns ON each channel's input.
5	Block	On	--	Turns ON input for all channels in the Input Master window. When turned ON, the [On] button lights up.
6		Off	--	Turns OFF input for all channels in the Input Master window.
7		Nominal	--	Resets all input signal levels in the Input Master window, making them 0 dB.
8		Minimum	--	Resets all input signal levels in the Input Master windows, making them $-\infty$ dB.

Output Master

If you click the [Output Master] button in the delay matrix component editor, it will open the [Delay Matrix - OutputMaster] editor window. Here you can turn the master output for each channel ON and OFF and set the level.

[Delay Matrix - OutputMaster] editor window



	Section	Parameter	Setting Range	Function
1	Output	Meter	--	Displays the output signal level for each channel.
2		Level	$-\infty$ to +10 dB	Sets the output signal level for each channel.
3		On	ON/OFF	Turns ON each channel's output.

	Section	Parameter	Setting Range	Function
4	Block	On	--	Turns ON output for all channels in the Output Master window. When turned ON, the [On] button lights up.
5		Off	--	Turns OFF output for all channels in the Output Master window.
6		Nominal	--	Resets all output signal levels in the Output Master window, making them 0 dB.
7		Minimum	--	Resets all output signal levels in the Output Master window, making them $-\infty$ dB.

■ All Inputs to One Output

When you click the output channel number on the matrix, the [Delay Matrix - All Inputs to One Output] editor window opens. One output channel and the send levels from each input channel to the output bus are displayed. The output channel is the one you have clicked on in the delay mixer component editor.



	Section	Parameter	Setting Range	Function
1	Bus Send Level	Delay	0 to 500ms	Sets the delay time from each input channel to the output bus.
2		Level	$-\infty$ to +10 dB	Sets the send level from each input channel to the output bus.
3		On	ON/OFF	Turns ON the send from each input channel to the output bus.
4	Output	Channel	--	Displays the selected output channel. Select another channel from a menu.
5		On	ON/OFF	Turns ON the output for the channel displayed in the window.
6		Meter	--	Displays the output signal level of the channel displayed in the window.
7	Block	On	--	Turns ON send from all input channels. When turned ON, the [On] button lights up.
8		Off	--	Turns OFF send from all input channels.
9		Nominal	--	Resets all of send levels, making them 0 dB.
10		Minimum	--	Resets all send levels, making them $-\infty$ dB.

Output Channel Switching

The [Delay Matrix - All Inputs to One Output] editor window displays the output channel clicked on in the delay matrix component editor. The [Channel] buttons in the [Output] section of the [Delay Matrix - All Inputs to One Output] editor window switch the channel group that is displayed in the window.



If you make the delay matrix component editor active while the [Delay Matrix - All Inputs to One Output] editor window is displayed, and then click another output channel, that channel group will be displayed in the [Delay Matrix - All Inputs to One Output] editor window.

One [Delay Matrix - All Inputs to One Output] editor window is displayed for each delay matrix component editor.

■ One Input to All Outputs

When you click the input channel number on the left side of matrix, the [Delay Matrix - One Input to All Outputs] editor window opens. One input channel and the send levels from the input channel to all output buses are displayed. The input channel is the one you have clicked on in the delay mixer component editor.



	Section	Parameter	Setting Range	Function
1	Input	Channel	--	Displays the selected input channel. Select another channel from a menu.
2		Phase	ON/OFF	Reverses the phase of the input signal.
3		Level	-∞ to +10 dB	Sets the input signal level.
4		Solo	ON/OFF	Turns solo ON. If Solo is engaged for even one channel, all non-Solo channels will be muted.
5		On	ON/OFF	Turns input ON.
6	Bus Send Level	Delay	0 to 500 ms	Sets the delay time from the input channel to each output bus.
7		Level	-∞ to +10 dB	Sets the send levels from the input channel to each output bus.
8		On	ON/OFF	Turns ON the send from the input channel to each output bus.

	Section	Parameter	Setting Range	Function
9	Block	On	--	Turns ON send to all channel buses. When turned ON, the [On] button lights up.
10		Off	--	Turns OFF send to all channel buses.
11		Nominal	--	Resets all send levels, making them 0 dB.
12		Minimum	--	Resets all send levels, making them $-\infty$ dB.

Input Channel Switching

The [Delay Matrix - One Input to All Outputs] editor window displays the input channel for the channel number clicked on in the delay matrix component editor.

The [Channel] buttons in the [Input] section of the [Delay Matrix - All Inputs to One Output] editor window switch the channel group that is displayed in the window.



If you make the delay matrix component editor active while the [Delay Matrix - One Input to All Outputs] editor window is displayed, and then click another input channel, that channel will be displayed in the [Delay Matrix - One Input to All Outputs] editor window.

One [Delay Matrix - One Input to All Outputs] editor window is displayed for each delay matrix component editor.

■ Crosspoint

If you click a level meter in the delay matrix component editor, that group's [Delay Matrix - Crosspoint] editor window will be displayed. Adjusts the send levels from each input channel to output buses and turns them ON and OFF. Just like the delay matrix component editor, the input channels are arranged vertically while the output channels are arranged horizontally.

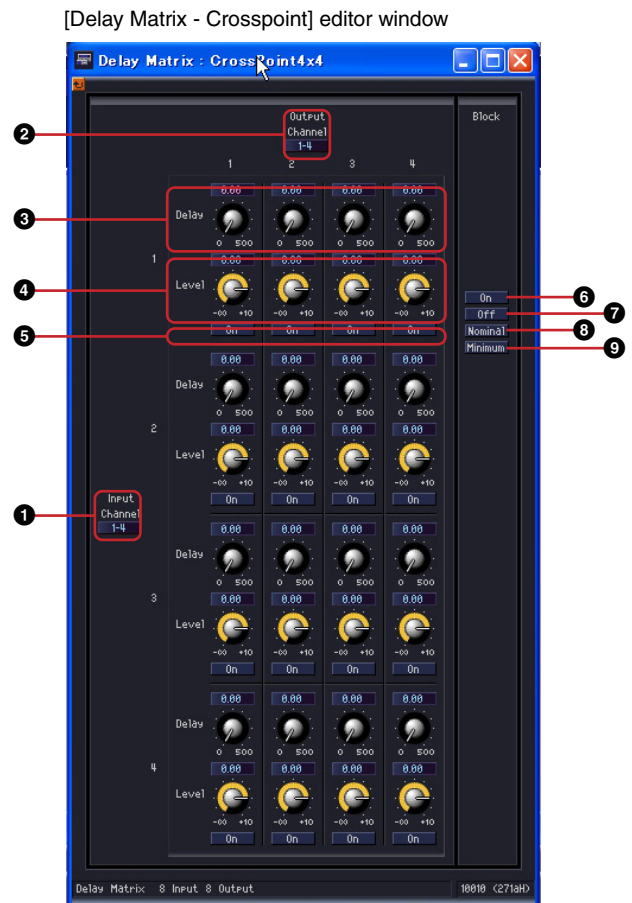

	Section	Parameter	Setting Range	Function
1	Input	Channel	--	Switches to another channel group.
2	Output	Channel	--	Switches to another channel group.
3	Bus Send Level	Delay	0 to 500 ms	Sets the delay time for each crosspoint.
4		Level	-∞ to +10 dB	Sets the send level for each crosspoint.
5		On	ON/OFF	Turns ON send for each crosspoint.
6	Block	On	--	Turns ON all sends in the Crosspoint window. The [On] button lights up.
7		Off	--	Turns OFF all sends in the Crosspoint window.
8		Nominal	--	Resets all send levels in the Crosspoint window, making them 0 dB.
9		Minimum	--	Resets all send levels in the Crosspoint window, making them -∞ dB.

Channel Group Switching

The [Delay Matrix - Crosspoint] editor window displays four channels each for Input and Output. It displays the channel group you click on in the delay matrix component editor. The [Channel] buttons in the [Input] and [Output] sections of the [Delay Matrix - Crosspoint] editor window switch the channel group that is displayed in the window.



[Input] section [Channel] menu



[Output] section [Channel] menu

If you click another channel group when the delay matrix component editor is active and an [Delay Matrix - Crosspoint] editor window is displayed, that channel group will be displayed in the open [Delay Matrix - Crosspoint] editor window. Only one [Delay Matrix - Crosspoint] matrix window is displayed for each delay matrix component editor.

Matrix Mixer

In the matrix mixer, the input channels and output buses are arranged in a checkerboard configuration. You can adjust the group balance for each output bus. There are 32 components in the Matrix Mixer group, each with different numbers of input and output channels. There are eight groups based on the number of inputs, as follows: 2 Input, 4 Input, 8 Input, 12 Input, 16 Input, 24 Input, 32 Input, and 64 Input.

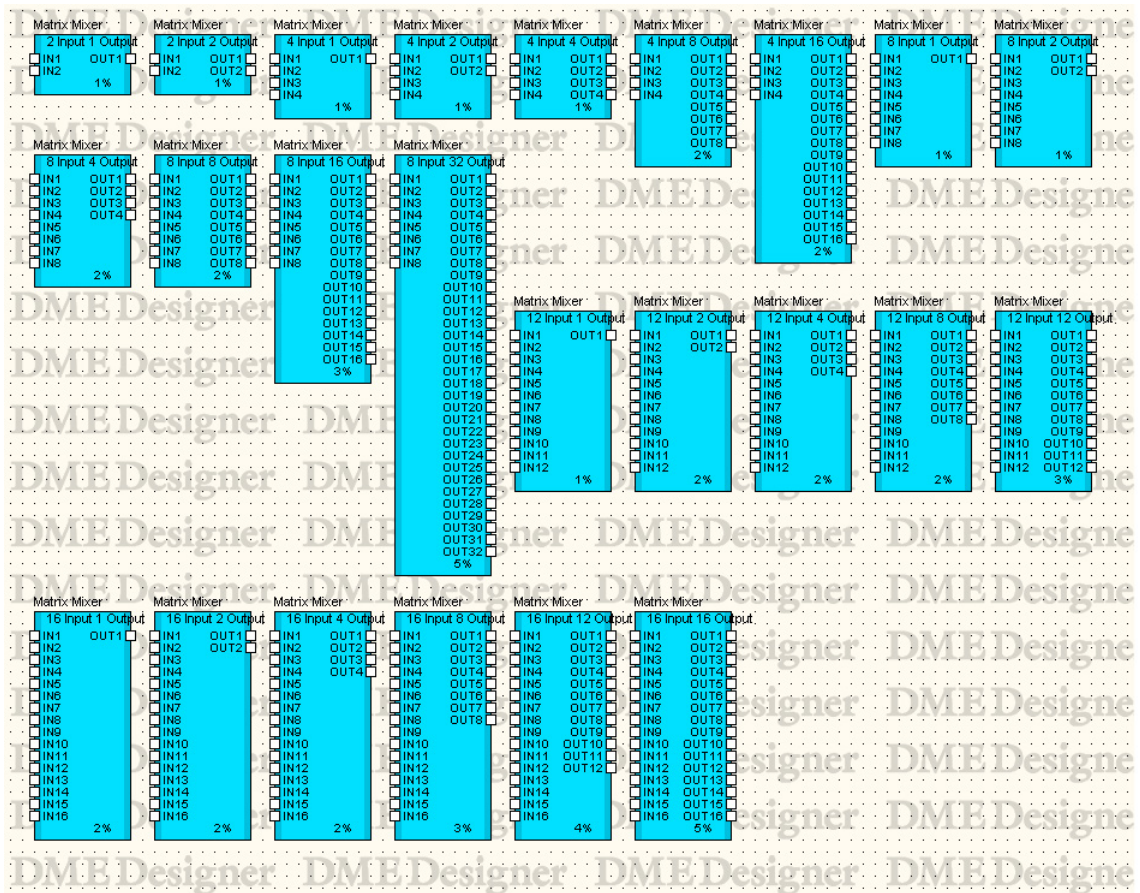



NOTE

If a 64 input 64 output Matrix Mixer component or a 64 input 32 output Matrix Mixer component is placed in the DME64N configuration window, no other components can be used even though the resource meter does not reach 100%.

Double-click a component to display the component editor for it. The number of input and output channels varies depending on the component, but all share a common configuration in the component editor. The matrix mixer component editor consists of four sections: input, output, matrix, and block. The [Master] buttons in the [Input] and [Output] sections display windows where you can make master input and output settings. The level for each channel is set in separate windows that display four channels each.

Matrix Mixer component editor

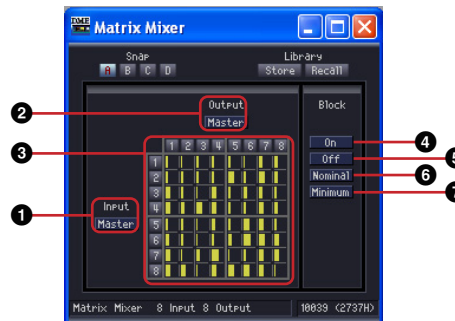

Section	Name	Function
1	Input Master	Opens the Input Master window.
2	Output Master	Opens the Output Master window.
3	Matrix Send level	These meters display the send levels from each input channel to all output buses. Clicking here displays the Crosspoint window.
4	Block On	Turns ON send from all input channels to output buses. The [ON] button lights up.
	Block Off	Turns OFF send from all input channels to output buses.
	Block Nominal	Resets all send levels, making them 0 dB.
	Block Minimum	Resets all send levels, making them $-\infty$ dB.

■ Matrix (Output Level)

In the matrix, you can view send levels from all output channels to output buses at once. The level will be grayed out when the corresponding send is set to Off.

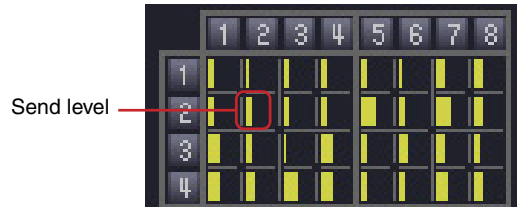

When you click an output channel number on the matrix, the [Matrix Mixer - All Inputs to One Output] editor window opens. When you click the input channel number on the left side of the matrix, the [Matrix Mixer - One Input to All Outputs] editor window opens.

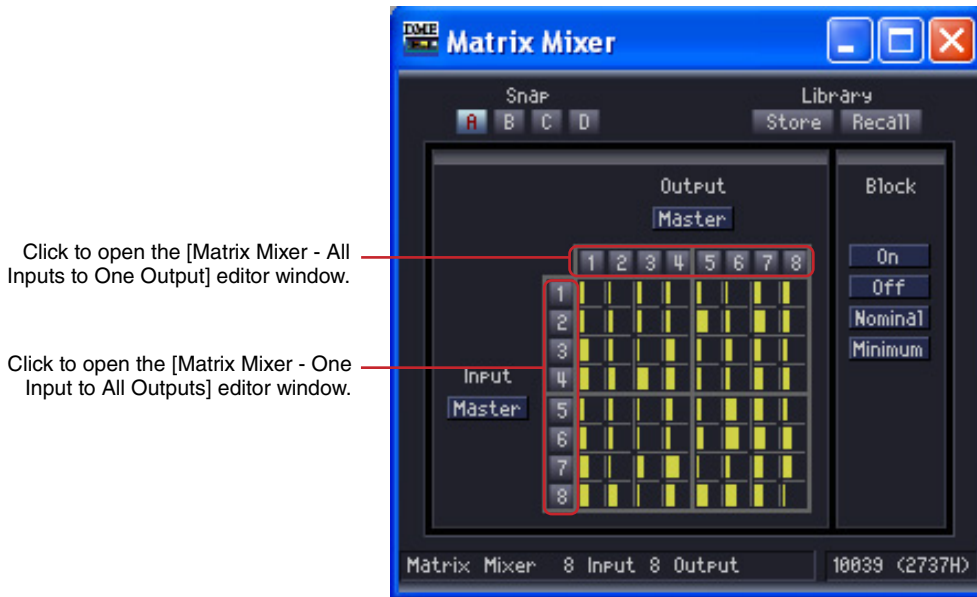

The matrix is divided into groups, each with four input channels and four output channels. When you place the mouse pointer over a group, its channel numbers are highlighted. Click to open the [Matrix Mixer - Crosspoint] editor window.

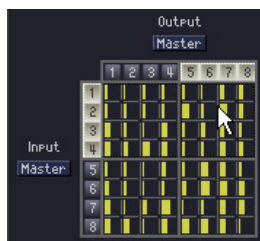

Click to open the "In 1-4 x Out 5-8" [Matrix Mixer - Crosspoint] editor window

Input Master

If you click the [Input Master] button in the matrix mixer component editor, it will open the [Matrix Mixer - InputMaster] editor window. Here you can turn the master input for each channel ON and OFF and set the level.

[Matrix Mixer - InputMaster] editor window



	Section	Parameter	Setting Range	Function
1	Input	Phase	ON/OFF	Reverses the phase of each channel's signal.
2		Level	$-\infty$ to +10 dB	Sets the input level to each input channel.
3		Solo	ON/OFF	Turns ON solo for each channel. If Solo is engaged for even one channel, all non-Solo channels will be muted.
4		On	ON/OFF	Turns ON each channel's input.
5	Block	On	--	Turns ON input for all channels in the Input Master window. When turned ON, the [On] button lights up.
6		Off	--	Turns OFF input for all channels in the Input Master window.
7		Nominal	--	Resets all output signal levels in the Input Master window, making them 0 dB.
8		Minimum	--	Resets all output signal levels in the Input master window, making them $-\infty$ dB.

Output Master Window

If you click the [Output Master] button in the matrix mixer component editor, it will open the Output Master window. Here you can turn the master output for each channel ON and OFF and set the level.

[Matrix Mixer - OutputMaster] editor window



	Section	Parameter	Setting Range	Function
1	Output	Meter	--	Displays the output signal level for each channel.
2		Level	$-\infty$ to +10 dB	Sets the output signal level for each channel.
3		On	ON/OFF	Turns ON each channel's output.
4	Block	On	--	Turns ON output for all channels in the Output Master window. When turned ON, the [On] button lights up.
5		Off	--	Turns OFF output for all channels in the Output Master window.
6		Nominal	--	Resets all output signal levels in the Output Master window, making them 0 dB.
7		Minimum	--	Resets all output signal levels in the Output Master window, making them $-\infty$ dB.

■ All Inputs to One Output

When you click the output channel number on the matrix, the [Matrix Mixer - All Inputs to One Output] editor window opens. One output channel and the send levels from each input channel to the output bus are displayed. The output channel is the one you have clicked on in the matrix mixer component editor.

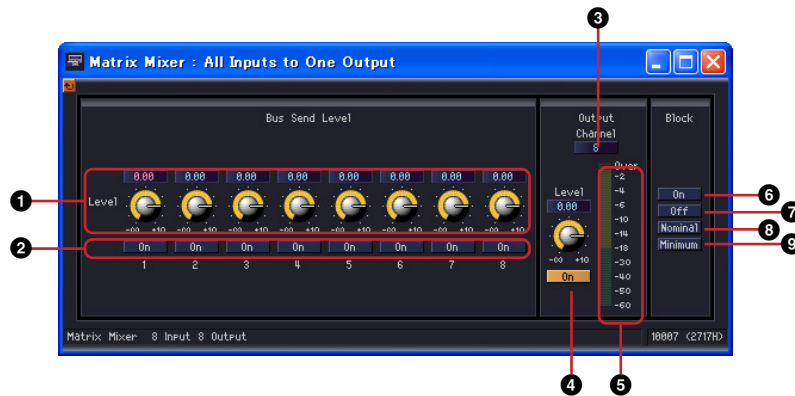

	Section	Parameter	Setting Range	Function
1	Bus Send Level	Level	$-\infty$ to +10 dB	Sets the send level from each input channel to the output bus.
2		On	ON/OFF	Turns ON the send from each input channel.
3	Output	Channel	--	Displays the selected output channel. Select another channel from a menu.
4		On	ON/OFF	Turns ON the output for the channel displayed in the window.
5		Meter	--	Displays the output signal level of the channel displayed in the window.
6	Block	On	--	Turns ON send from all input channels. When turned ON, the [On] button lights up.
7		Off	--	Turns OFF send from all input channels.
8		Nominal	--	Resets all send levels, making them 0 dB.
9		Minimum	--	Reset all send levels, making them $-\infty$ dB.

Output Channel Switching

[Matrix Mixer - All Inputs to One Output] editor window displays the output channel clicked in the matrix mixer component editor. The [Channel] buttons in the [Output] section of the [Matrix Mixer - All Inputs to One Output] editor window switch the channel group that is displayed in the window.



If you make the matrix mixer component editor active while the [Matrix Mixer - All Inputs to One Output] editor window is displayed, and then click another output channel, that channel group will be displayed in the [Matrix Mixer - All Inputs to One Output] editor window. One [Matrix Mixer - All Inputs to One Output] editor window is displayed for each matrix mixer component editor.

■ One Input to All Outputs

When you click the input channel number on the left side of the matrix, the [Matrix Mixer - One Input to All Outputs] editor window opens. One input channel and the send levels from the input channel to all output buses are displayed. The input channel is the one you have clicked on in the delay mixer component editor.

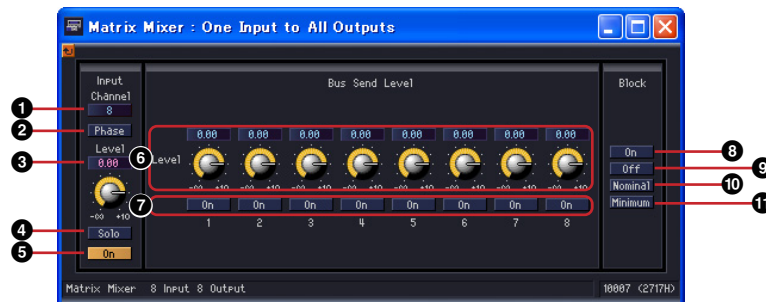

	Section	Parameter	Setting Range	Function
1	Input	Channel	--	Displays the selected input channel. Select another channel from a menu.
2		Phase	ON/OFF	Reverses the phase of the input signal.
3		Level	-∞ to +10 dB	Sets the input signal level.
4		Solo	ON/OFF	Turns solo ON. If Solo is engaged for even one channel, all non-Solo channels will be muted.
5		On	ON/OFF	Turns input ON.
6	Bus Send Level	Level	-∞ to +10 dB	Sets the send level from the input channel to each output bus.
7		On	ON/OFF	Turns ON the send from the input channel to each output bus.
8	Block	On	--	Turns ON send to all channel buses. When turned ON, the [On] button lights up.
9		Off	--	Turns OFF send to all output buses.
10		Nominal	--	Resets all send levels, making them 0 dB.
11		Minimum	--	Resets all send levels, making them -∞ dB.

Input Channel Switching

The [Matrix Mixer - One Input to All Outputs] editor window displays the input channel for the channel number clicked on in the matrix mixer component editor.

The [Channel] buttons in the [Input] section of the [Matrix Mixer - All Inputs to One Output] editor window switch the channel group that is displayed in the window.



If you make the matrix mixer component editor active while the [Matrix Mixer- One Input to All Outputs] editor window is displayed, and then click another input channel, that channel will be displayed in the [Matrix Mixer - One Input to All Outputs] editor window.

One [Matrix Mixer - One Input to All Outputs] editor window is displayed for each matrix mixer component editor.

■ Crosspoint

If you click a level meter in the matrix mixer component editor, the output crosspoint window for the group will be displayed. Adjusts the send levels from each input channel to output buses and turns them ON and OFF. Just like the matrix mixture component editor, the input channels are arranged vertically while the output channels are arranged horizontally.

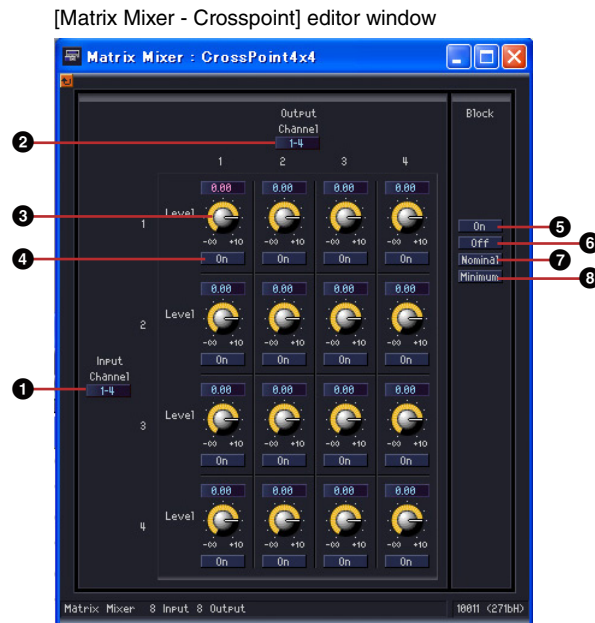

	Section	Parameter	Setting Range	Function
1	Input	Channel	--	Switches to another channel group.
2	Output	Channel	--	Switches to another channel group.
3	Bus Send Level	Level	$-\infty$ to +10 dB	Sets the send level for each crosspoint.
4		On	ON/OFF	Turns ON send for each crosspoint.
5	Block	On	--	Turns ON all sends in the Crosspoint window. When turned ON, the [On] button lights up.
6		Off	--	Turns OFF all sends in the Crosspoint window.
7		Nominal	--	Resets all send levels in the Crosspoint window, making them 0 dB.
8		Minimum	--	Resets all send levels in the Crosspoint window, making them $-\infty$ dB.

Channel Group Switching

The [Matrix Mixer - Crosspoint] editor window displays four channels each for Input and Output. It displays the channel group that was clicked on in the matrix mixer component editor. The [Channel] buttons in the [Input] and [Output] sections of the [Matrix Mixer - Crosspoint] editor window switch the channel group that is displayed.



If you click another channel group when the matrix mixer component editor is active and an [Matrix Mixer - Crosspoint] editor window is displayed, that channel group will be displayed in the open [Matrix Mixer - Crosspoint] editor window. Only one [Matrix Mixer - Crosspoint] matrix window is displayed for each matrix mixer component editor.

Simple Mixer

This is a simple mixer with AUX and PFL facilities. 16-channel and 24-channel types are provided.

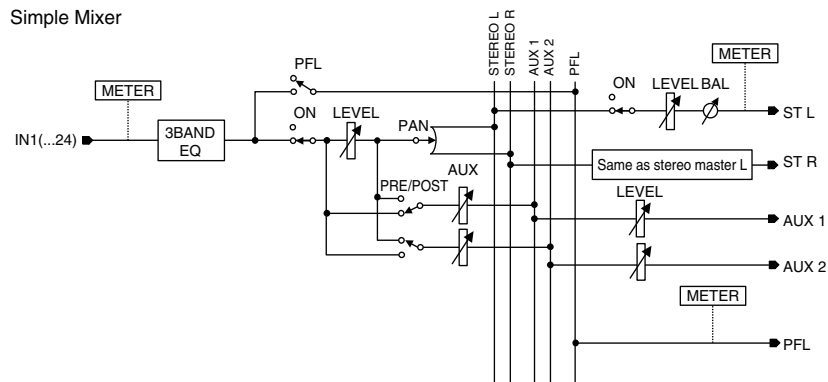
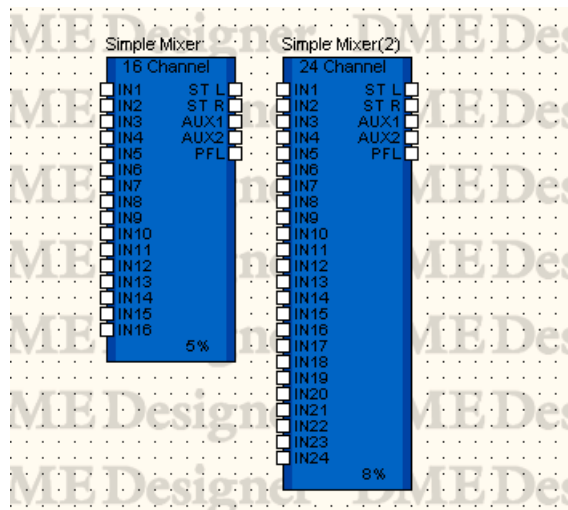

Double-click the component to open the component editor. The component editor is the same for the 16-input and 24-input types, the only difference being the number of channels. The Simple Mixer component editor is organized into input channel and master output sections.

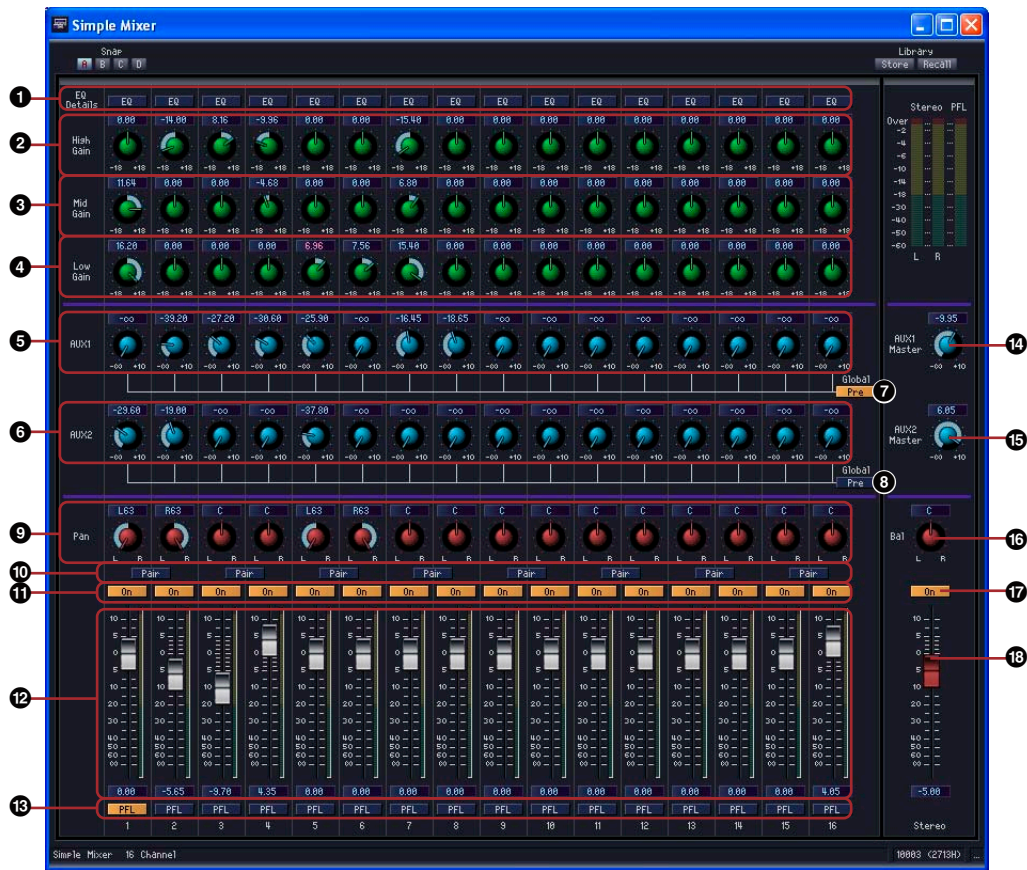

	Section	Parameter	Setting Range	Function
1	Input Channel	EQ Details		Opens the EQ editor window.
2		High Gain	-18.0 to +18.0 dB	Sets the gain of the EQ High band.
3		Mid Gain	-18.0 to +18.0 dB	Sets the gain of the EQ Mid band.
4		Low Gain	-18.0 to +18.0 dB	Sets the gain of the EQ Low band.
5		AUX1 Send	$-\infty$ to +10.0 dB	Sets the AUX1 send level.
6		AUX2 Send	$-\infty$ to +10.0 dB	Sets the AUX2 send level.
7		AUX1 Send Point	Pre/Post	Switches the AUX1 send point to pre-fader (Pre) or post-fader (Post).
8		AUX2 Send Point	Pre/Post	Switches the AUX2 send point to pre-fader (Pre) or post-fader (Post).
9		Pan	L63 – Center – R63	Sets the pan position.
10		Pair	ON/OFF	Engages paired operation for odd and even channel pairs. (excluding Pan, PFL, and AUX Send operation). When turned ON the odd-channel parameters are copied to the even channel. When ON Pan functions in LR Nominal mode (nominal level when pan is full left or right) and when OFF Pan functions in Center Nominal mode (nominal level when pan is center).
11		On	ON/OFF	Turns the input of each channel ON.
12		Fader	$-\infty$ to +10.0 dB	Sets the input level for each input channel.

	Section	Parameter	Setting Range	Function
13		PFL	ON/OFF	Engages PFL send. The last selected channel is given priority.
14	Master Output	AUX1 Master	$-\infty$ to +10.0 dB	Adjusts the AUX1 master level.
15		AUX2 Master	$-\infty$ to +10.0 dB	Adjusts the AUX2 master level.
16		Bal	L63 – Center – R63	Sets the pan position of the stereo output.
17		On	ON/OFF	Turns master output ON.
18		Fader	$-\infty$ to +10.0 dB	Sets the master output level.

■ EQ Editor Window

Click the Simple Mixer EQ Details [EQ] button to open the EQ editor window via which EQ can be adjusted for each channel.

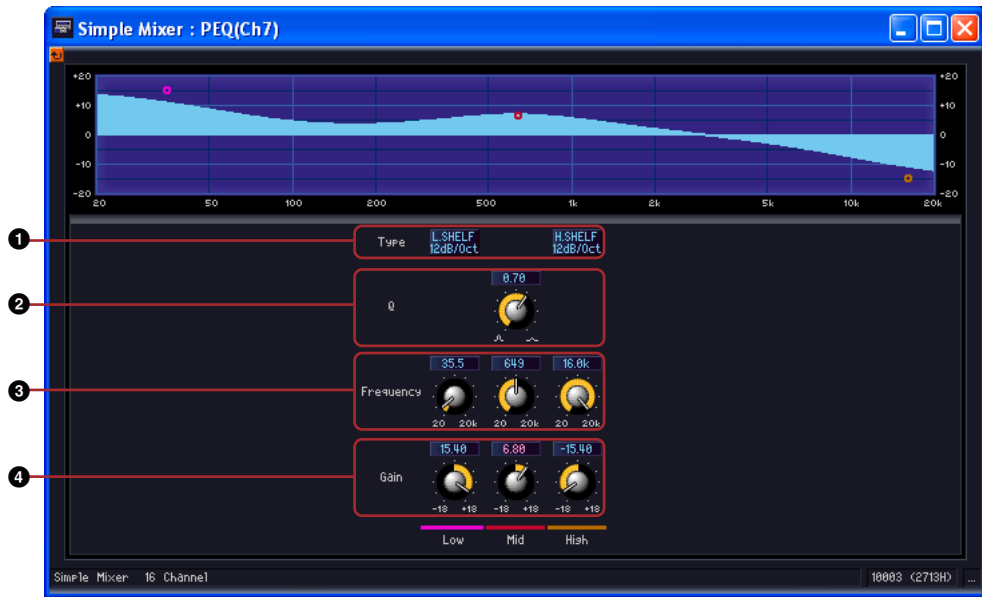

	Parameter	Setting Range	Function
1	Type	PEQ, L.SHELF 6dB/oct, L.SHELF 12dB/oct, H.SHELF 6dB/oct, H.SHELF 12dB/oct	Selects the filter type for the Low and High bands.
2	Q	16.0 to 0.1	Sets the Q for each band.
3	Frequency	20 Hz to 20 kHz	Sets the center frequency for each band.
4	Gain	-18.0 to +18.0 dB	Sets the gain for each band.

Pan

The Pan group contains the following subgroups: LCR, LR, and Surround.

■ Pan Nominal Position

Component editors contain the “Pan Nominal Position” parameter.

The button for that parameter displays its current setting. Clicking the button displays a menu with [Center] and [LR], which are used to set the pan 0 dB reference.



Center (Center Nominal)

Level is nominal when pan is at center position. Level is +3dB when pan is full left or right.

LR (LR Nominal)

Level is nominal when pan is full left or right.

LCR

In the LCR component, one input is divided into left, center, and right outputs. The number of outputs is triple the inputs. Components are available with 1, 2, 4, 8, 12, and 16 channels.

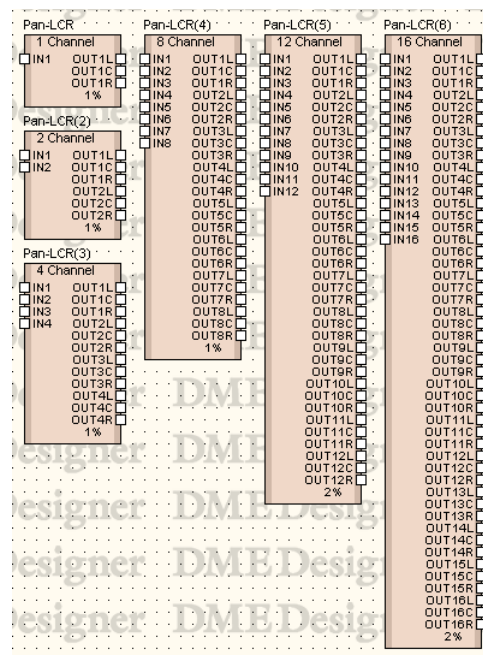

Double-click a component to display the component editor for it. The number of channels varies depending on the component, but all share a common configuration in the component editor.

LCR component editor



	Parameter	Setting Range	Function
1	CSR	0 to 100%	Sets the signal level sent to the center channel, in relation to the signal level sent to the L and R channels.
2	Pan	L63 - Center - R63	Sets LR orientation.
3	Pan Nominal Position	Center LR	Selects the nominal position from a menu.

LR

Separates a single input into left and right outputs. Components are available with 1, 2, 4, 8, 12, and 16 channels.

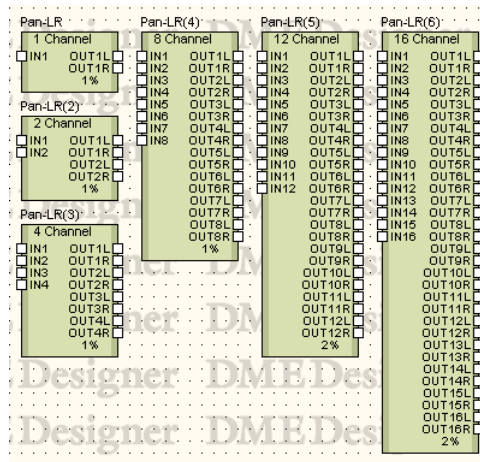

Double-click a component to display the component editor for it. The number of channels varies depending on the component, but all share a common configuration in the component editor.

Pan component editor



	Parameter	Setting Range	Function
1	Pan	L63 - R63	Sets the LR orientation.
2	Pan Nominal Position	Center LR	Selects the nominal position from a menu.

Surround

There are three types of surround pan components in the Surround subgroup: 3-1, 5.1, and 6.1. The surround pan component editor has a two-dimensional surround pan graph where you can set the location of the sound image.

Surround 6.1 component editor

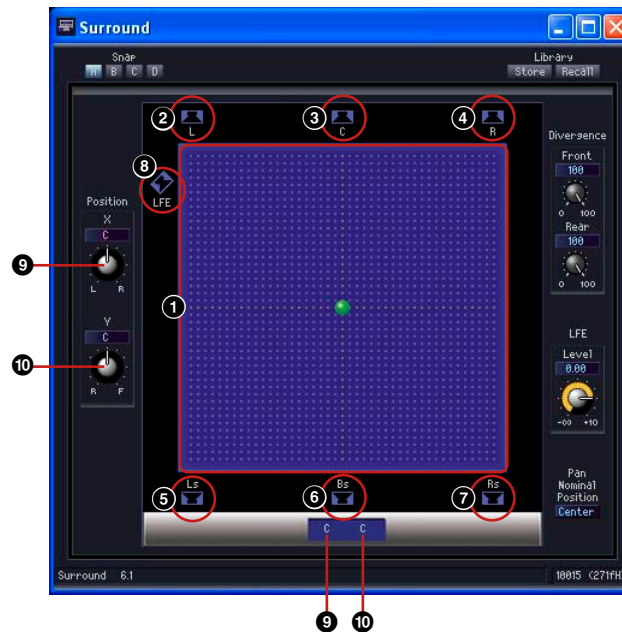

	Name		Location, Setting Range	Function	
1	2D Surround Pan Graph		--	Sets the sound image orientation. You can move the sound image by clicking and dragging.	
2	Speaker Button	L	Left	L63 F63	Clicking here moves the sound image to the button location.
3		C	Center	C F63	
4		R	Right	R63 F63	
5		Ls	Left Surround	L63 R63	
6		Bs	Back Surround	C R63	
7		Rs	Right Surround	R63 R63	
8	LFE	Low Frequency Effect (Sub Woofer)	--	Indicates that there is a sub woofer. Clicking makes the LFE level 0 dB. The sound image does not move by clicking.	
9	Left-Right Position		L63 - C - R63	Displays and edits the LR sound image.	
10	Front-Back Position		L63 - C - R63	Displays and edits the front-back sound image.	

You can set the sound location using the mouse in the two-dimensional surround pan graph. The sound position cannot be changed via the numbers below the two-dimensional surround pan graph. To specify position numerically use the Position X/Y knobs to the left of the graph.



Dragging

You can move the control by dragging it with the mouse.

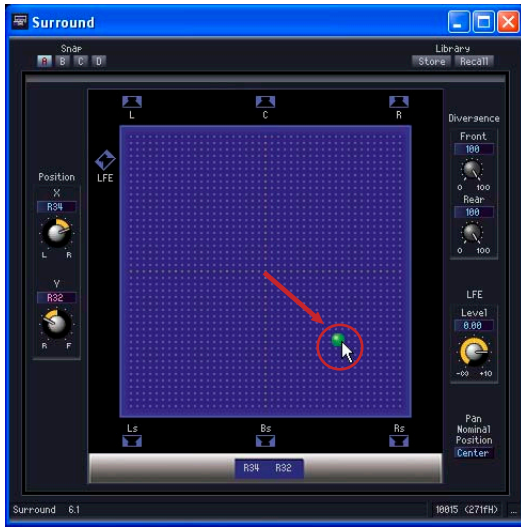

Click

If you click within the graph, the control point will move to that position.

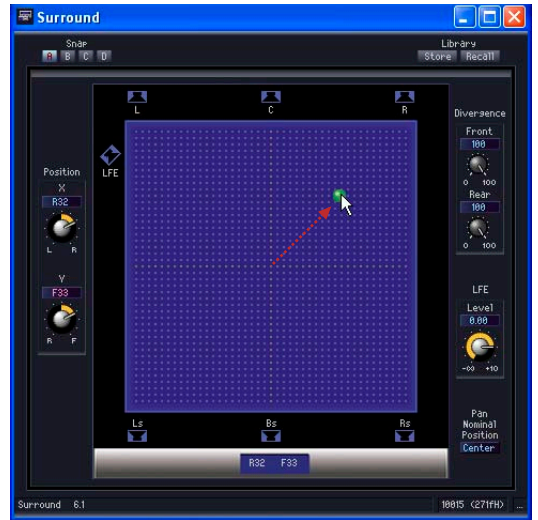
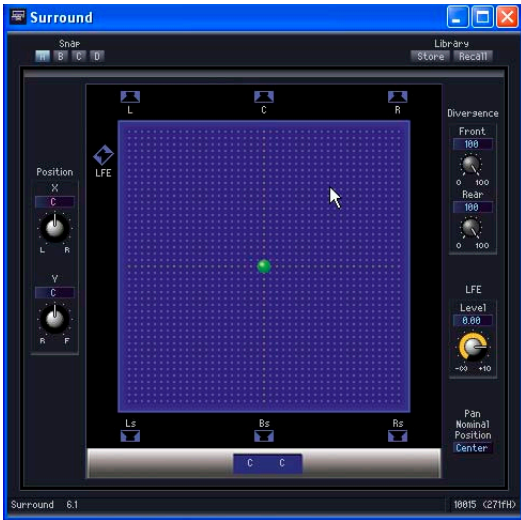

Speaker Button

If you click any speaker button besides the [LFE] button, the control point will jump to that speaker's position.

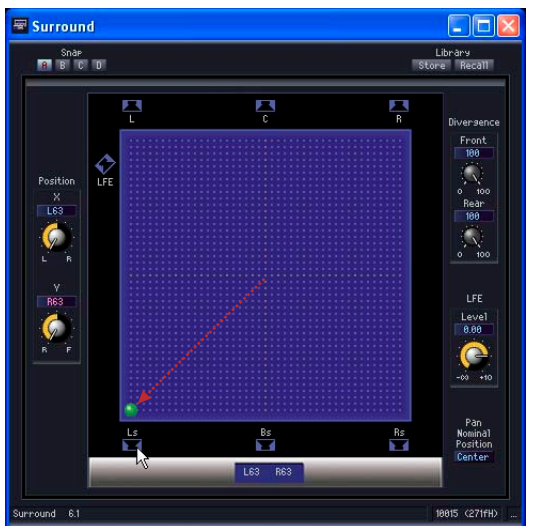
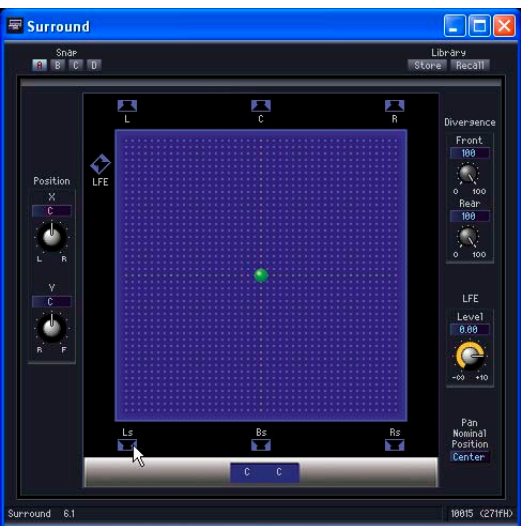

■ Surround 3-1

Surround 3-1 has four channel surround pan, with three channels in front, and one in the rear. There is one input and four outputs.

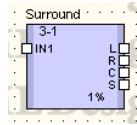

Double-click a component to display the component editor for it.

Surround 3-1 component editor

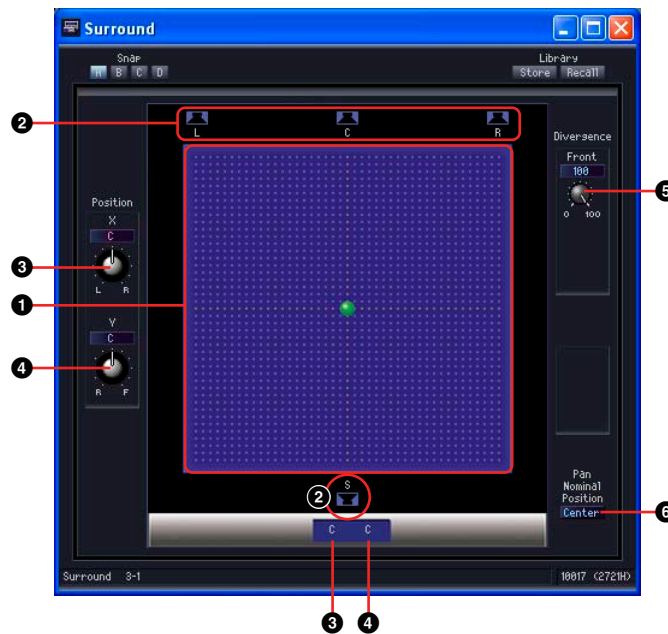

	Section	Name/Parameter	Setting Range	Function
1	2D Surround Pan Graph	2D Surround Pan Graph	--	Sets the sound image orientation. You can move the sound image by clicking and dragging.
2		Speaker Button	--	Clicking here moves the sound image to the button location.
3	Position	Left-Right Position	L63 - C - R63	Displays and edits the LR surround location.
4		Front-Back Position	F63 - C - R63	Displays and edits the front-back surround location.
5	Divergence	Front	0 to 100%	Sets the ratio for sending the front-center signal to front L and front R.
6	Pan Nominal Position		Center LR	Selects the nominal position from a menu.

Surround 5.1

Surround 5.1 has surround pan with three channels in front, two in the rear, and one sub woofer channel. There is one input and six outputs.

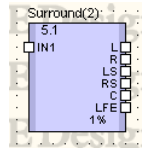

Double-click a component to display the component editor for it.

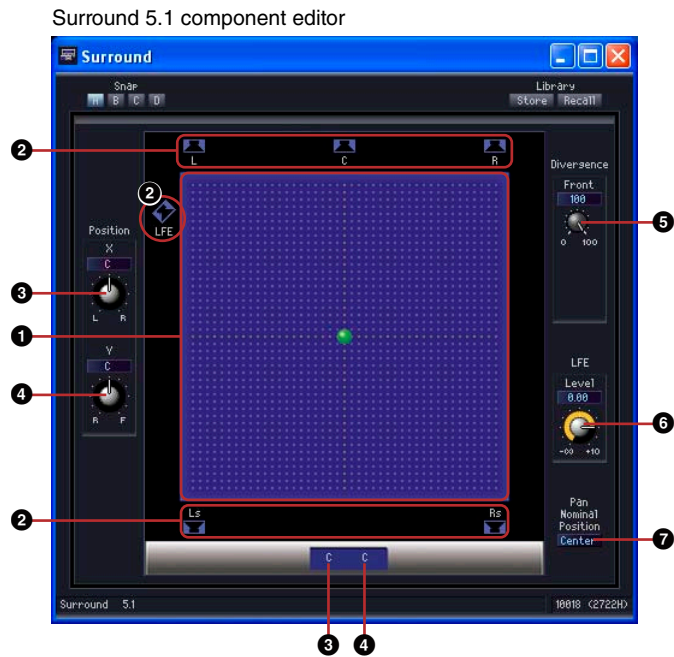

	Section	Name/Parameter	Setting Range	Function
1	2D Surround Pan Graph	2D Surround Pan Graph	--	Sets the sound image orientation. You can move the sound image by clicking and dragging.
2		Speaker Button	--	Clicking here moves the sound image to the button location.
3	Position	Left-Right Position	L63 - C - R63	Displays and edits the LR surround location.
4		Front-Back Position	F63 - C - R63	Displays and edits the front-back surround location.
5	Divergence	Front	0 to 100%	Sets the ratio for sending the front-center signal to front L and front R.
6	LFE	Level	-∞ to +10 dB	Sets output level to the sub woofer.
7	Pan Nominal Position		Center LR	Selects the nominal position from a menu.

■ Surround 6.1

Surround 6.1 has surround pan with three channels in front, three in the rear, and one sub woofer channel. There is one input and seven outputs.

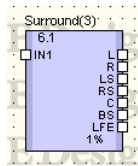

Double-click a component to display the component editor for it.

Surround 6.1 component editor

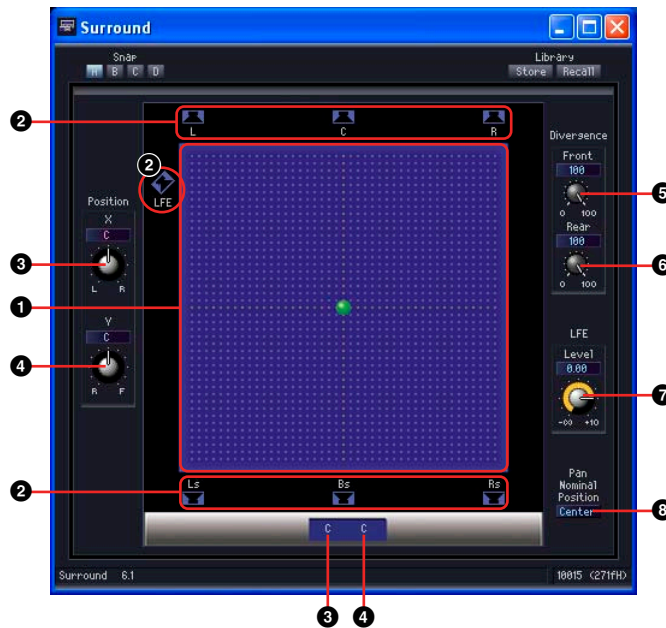

	Section	Name/Parameter	Setting Range	Function
1	2D Surround Pan Graph	2D Surround Pan Graph	--	Sets the sound image orientation. You can move the sound image by clicking and dragging.
2		Speaker Button	--	Clicking here moves the sound image to the button location.
3	Position	Left-Right Position	L63 - C - R63	Displays and edits the LR surround location.
4		Front-Back Position	F63 - C - R63	Displays and edits the front-back surround location.
5	Divergence	Front	0 to 100%	Sets the ratio for sending the front-center signal to front L and front R.
6		Rear	0 to 100%	Sets the ratio for sending the rear-center signal to rear L and rear R.
7	LFE	Level	-∞ to +10 dB	Sets output level to the sub woofer.
8	Pan Nominal Position		Center LR	Selects the nominal position from a menu.

Room Combiner

The Room Combiner component is for use in facilities where movable partitions allow rooms to be divided or combined. The audio feeds can be easily adjusted to match the physical room configuration.

For example, if Room 1 and Room 2 are to be combined to create a single large room, the audio feed for Room 1 can be connected to IN 1 of the component, and the audio feed for Room 2 can be connected to IN 2 of the component. Then when “Combine” for Room 1 and Room 2 is “ON,” the audio signals connected to IN 1 and IN 2 are summed and output via OUT 1 and OUT 2. When “Combine” for Room 1 and Room 2 is “OFF,” the IN 1 signal is sent to OUT 1 only, and the IN 2 signal is sent to OUT 2 only.

Components are available for combining up to 4, 8, 12, or 16 rooms.

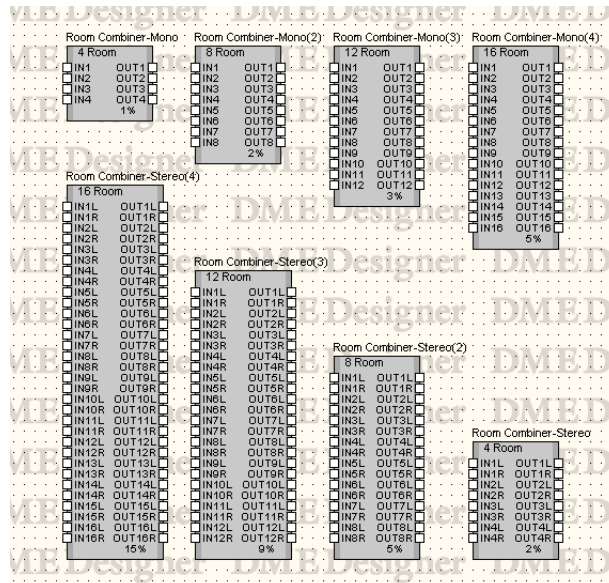

Double-click the component to open the component editor. The component editor is the same for all types, the only difference being the number of rooms.

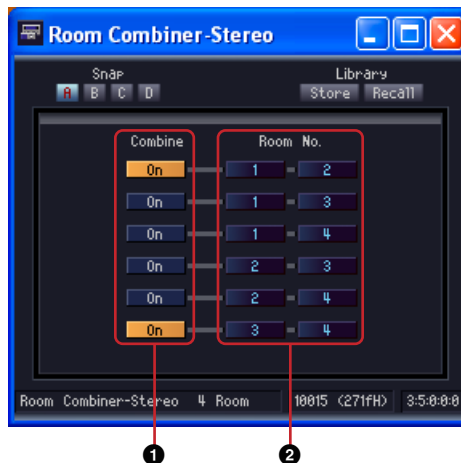

	Parameter	Setting Range	Function
1	Combine	ON/OFF	Specifies whether the rooms are to be combined or not.
2	Room No.	*1	Specifies the room number to be combined. “Room No.” refers to the numbers that are the component’s input port names.

*1 Depends on the number of rooms provided by the placed component.

Router

The router assigns inputs to outputs. Each of the six router groups has a different number of inputs. The groups are 1 input, 2 input, 4 input, 8 input, 12 input and 16 input. Each group has five components, with 2, 4, 8, 12, and 16 outputs. 32 input group has only 32 outputs component.

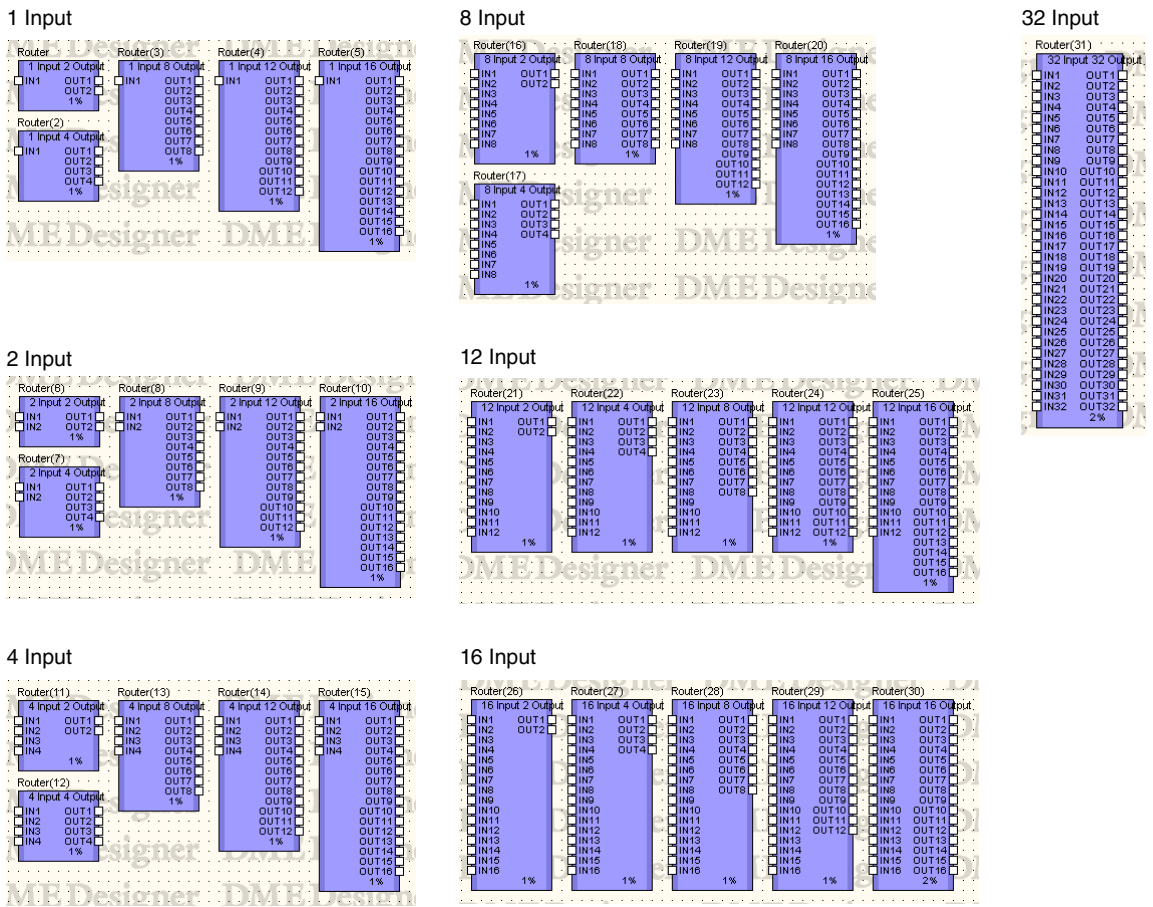

Double-click a component to display the component editor for it. The number of channels varies depending on the component, but all share a common configuration in the component editor.

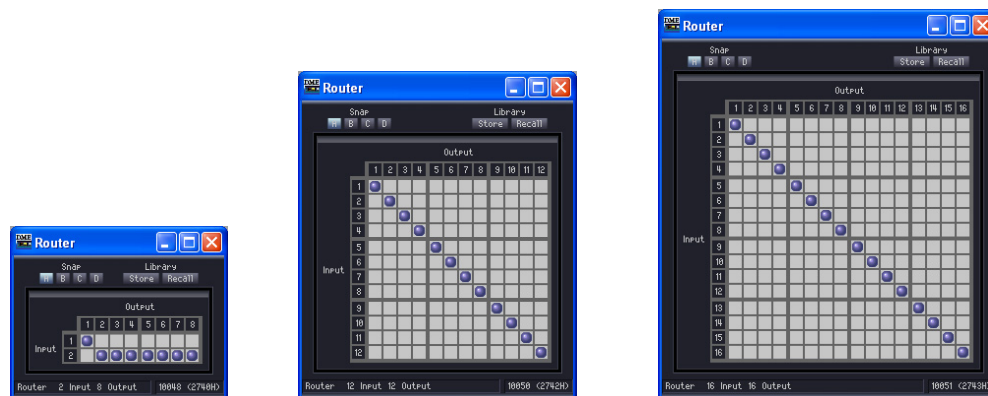

Routers let you route signals from various [Input] locations by connecting them to various [Output] locations.

One output can be connected to one input only. A single input can be output to multiple channels, but multiple inputs cannot be output over a single channel. In other words, you can distribute the inputs, but you cannot mix them. You cannot setup routing for more signals than the number of output channels.

■ Routing Settings

To change an assignment, click at the position where the desired input and output channels intersect. When the mouse pointer is moved over a cell, the input and output channels are highlighted, and a red line is displayed connecting them. Click to set routing for that position. If another output channel has been assigned to the clicked input channel, the original assignment will not be cleared. If another input channel has been assigned to the clicked output channel, the original assignment will be cleared.

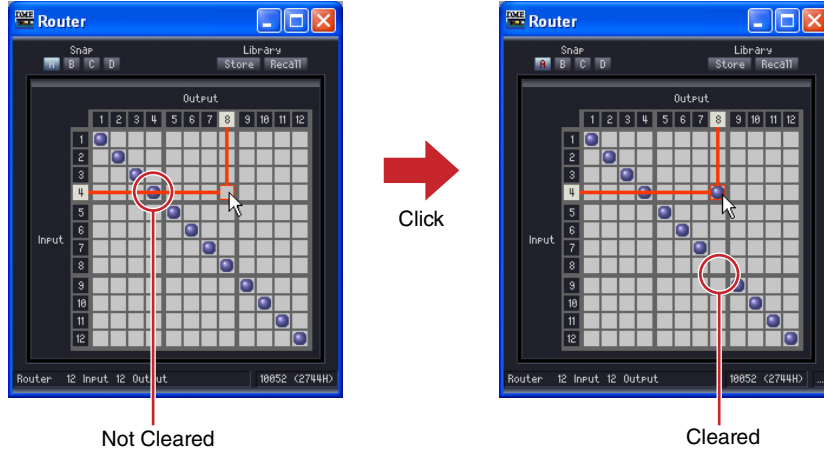

■ Clearing Routing Settings

If you click the dot that indicates routing, the routing indicated by that dot will be cleared and the dot will be erased.

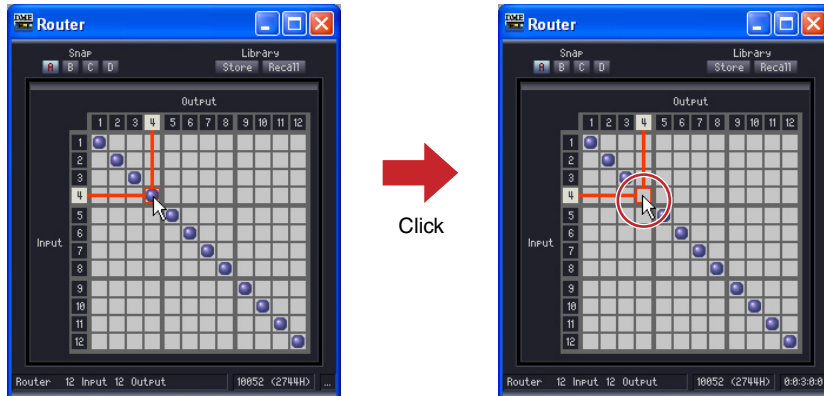

Source Selector

This component selects a single input source from multiple input sources.

“Position” is the number of input sources, and “Channel” is the number of channels included in the source. For example, a “4 Position 2 Channel” component allows you to select a single 2-channel source from four 2-channel input sources.

3 Position and 16 Position components are all 1 Channel types, while 1, 2, and 6 Channel versions of 4 Position and 8 Position components are provided.

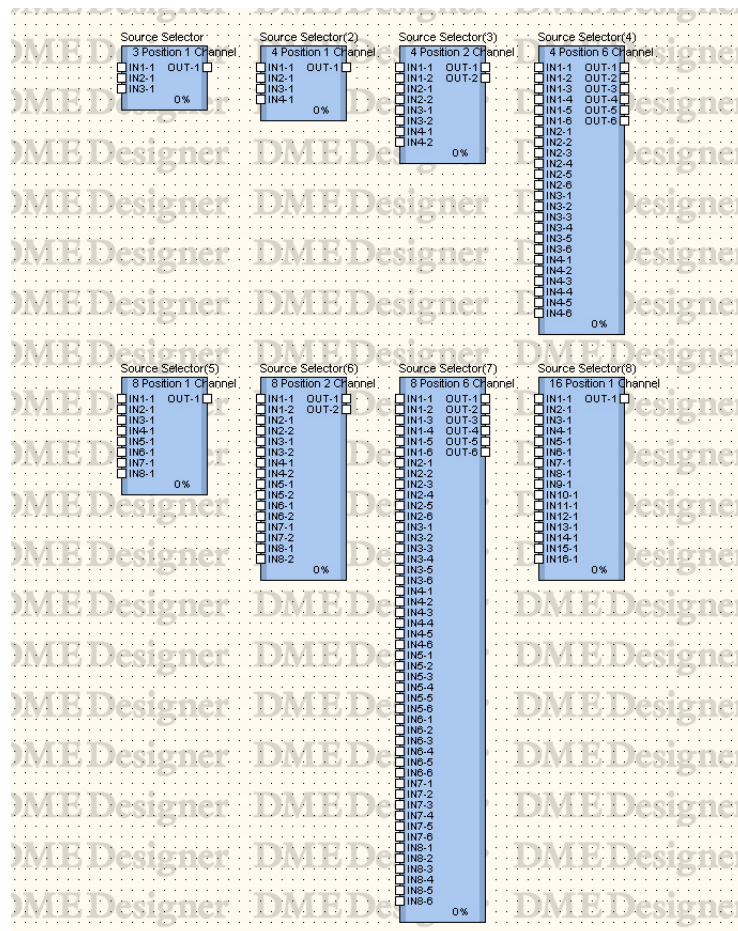

Double-click a component to open the component editor. The component editor is the same for all types, the only difference being the number of sources.

Source Selector Component



The Source Selector connects the selected input to the output. For example, if you select [1] for a 4 Position 2 Channel component, IN1-1 will be connected to OUT-1 and IN1-2 will be connected to OUT2. If you select [2] IN2-1 will be connected to OUT-1 and IN2-2 will be connected to OUT2.

Speaker Processor

The Speaker Processor is a crossover processor that includes APF (All Pass Filter), horn EQ, and limiter functions. Six component types are available: 1 Way, 2 Way, 3 Way, 4 Way, 5 Way, and 6 Way. Speaker Processor components have one input and one or multiple outputs.

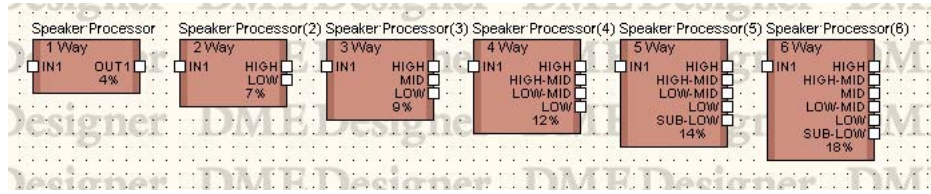

Double-click a component to open the component editor.

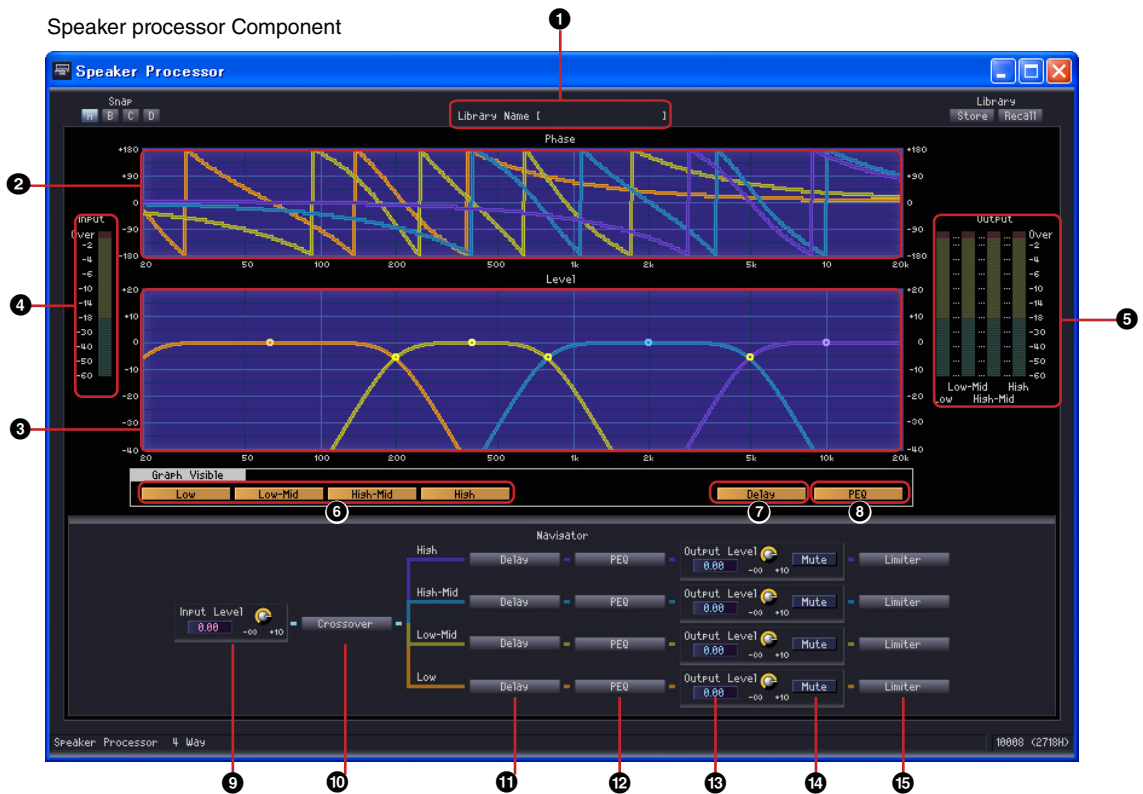

	Name	Function
1	Library name	Displays library name.
2	Crossover response (phase)	Crossover phase response, color coded for output channel.
3	Crossover response (level)	Crossover level response, color coded for each output channel.
4	Input meter	Displays the input signal level.
5	Output meter	Displays the output level for each band.
6	Crossover Curve Display Button	Turns crossover curve display for each output channel on or off.

	Section	Parameter	Range	Function
7	Delay	Delay	ON/OFF	Applies delay to the crossover response.
8	PEQ	PEQ	ON/OFF	Applies PEQ to the crossover response.
9	Navigator	Input Level	$-\infty$ to +10 dB	Specifies the input signal level.
10		Crossover	–	Opens the crossover editor window.
11		Delay	–	Opens the delay editor window.
12		PEQ	–	Opens the parametric equalizer editor window.
13		Output Level	$-\infty$ to +10 dB	Sets the output level from each output channel.
14		Mute	ON/OFF	Mutes the output of each output channel.
15		Limiter	–	Opens the limiter editor window.

Different numbers of channels are provided by each component variation.

1 Way	ALL
2 Way	Low/High
3 Way	Low/Mid/High
4 Way	Low/Low-Mid/High-Mid/High
5 Way	Sub-Low/Low/Low-Mid/High-Mid/High
6 Way	Sub-Low/Low/Low-Mid/Mid/High-Mid/High

Each frequency band has its own color, with Low being red, Mid being green, and so on.

■ Graph Control Points

The crossover level control points indicate [Output Level] and [Frequency]. The control points will move in response to [Output Level] changes made via the knobs or edit boxes. The [Output Level] and [Frequency] parameters can also be changed by directly dragging the control points. Changes to the [Frequency] parameter are shown on the crossover phase response graph.

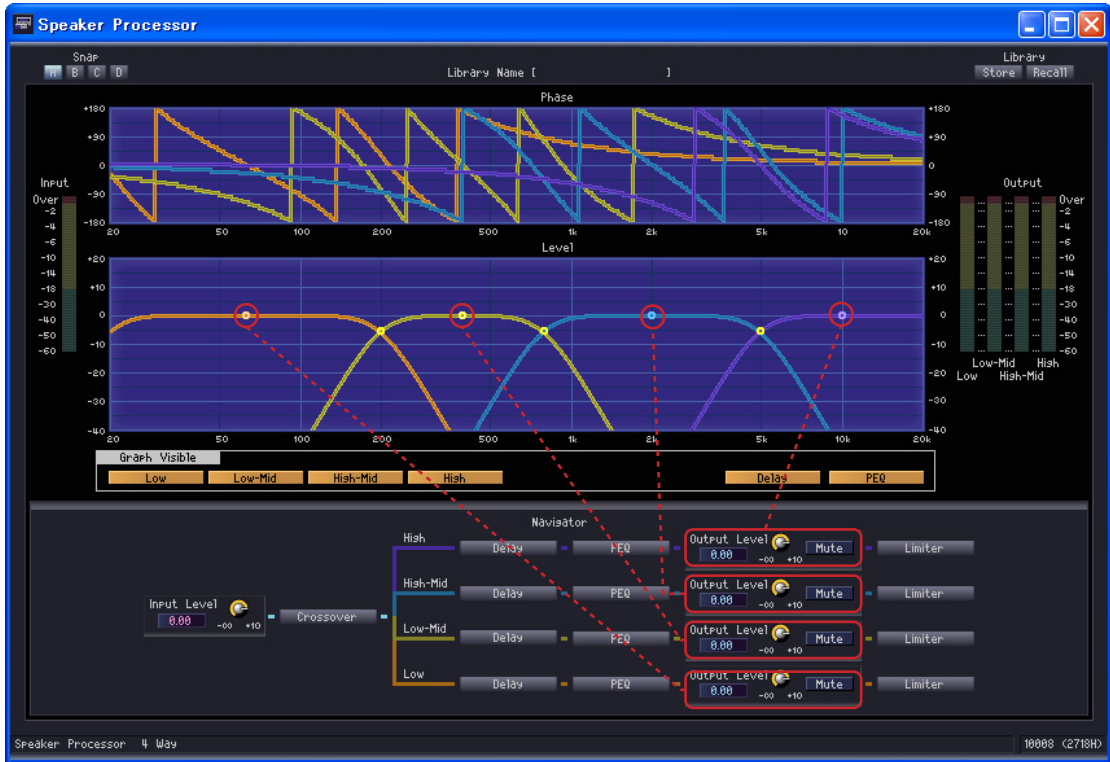

The control point in the center of the graph can be dragged vertically to change the [Output Level] parameter.

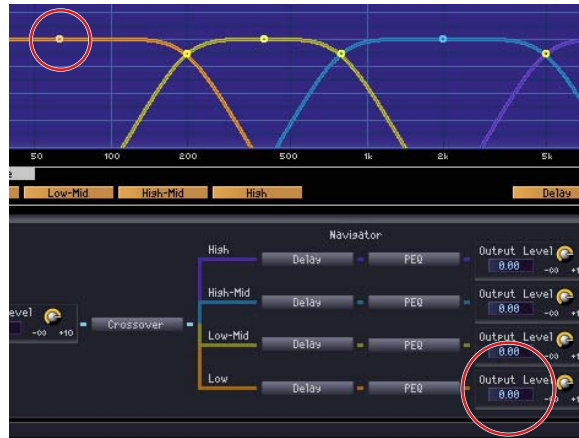

The [Output Level] parameter changes.

Control points at the intersections between the frequency bands can be dragged horizontally to change the [Frequency].

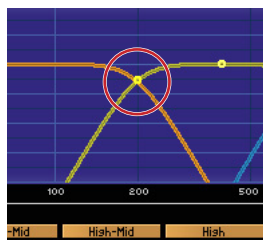

The crossover phase response will change.

■ Crossover

Click the Speaker Processor [Crossover] button to open the crossover editor window.

[Speaker Processor - Crossover] editor window



	Section	Parameter	Range	Function
1	Polarity		Normal/Inverted	Inverts the polarity of each output channel.
2	Mute		ON/OFF	Mutes the output of each output channel. This parameter is linked to the Mute setting in the original window.
3	Frequency		20 Hz to 20 kHz	Sets the crossover frequency between output channels. The display appears as a dotted line when muted.
4	LPF	Type	Thru 6dB/Oct 12dB/Oct AdjustGc 12dB/Oct Butwrth 12dB/Oct Bessel 12dB/Oct Linkwitz 18dB/Oct AdjustGc 18dB/Oct Butwrth 18dB/Oct Bessel 24dB/Oct AdjustGc 24dB/Oct Butwrth 24dB/Oct Bessel 24dB/Oct Linkwitz 36dB/Oct AdjustGc 36dB/Oct Butwrth 36dB/Oct Bessel 48dB/Oct AdjustGc 48dB/Oct Butwrth 48dB/Oct Bessel 48dB/Oct Linkwitz	Sets the roll-off slope and filter type for each octave. The filter is bypassed when [Thru] is selected.
5		Frequency	20 Hz to 20 kHz	Sets the LPF cutoff frequency.
6		Gc	-6 dB to +6 dB	Sets the cutoff frequency gain when the [Type] setting is [AdjustGc] (Adjustable Gc).

	Section	Parameter	Range	Function
7	HPF	Type	Thru 6dB/Oct 12dB/Oct AdjustGc 12dB/Oct Butwrth 12dB/Oct Bessel 12dB/Oct Linkwitz 18dB/Oct AdjustGc 18dB/Oct Butwrth 18dB/Oct Bessel 24dB/Oct AdjustGc 24dB/Oct Butwrth 24dB/Oct Bessel 24dB/Oct Linkwitz 36dB/Oct AdjustGc 36dB/Oct Butwrth 36dB/Oct Bessel 48dB/Oct AdjustGc 48dB/Oct Butwrth 48dB/Oct Bessel 48dB/Oct Linkwitz	Sets the roll-off slope and filter type for each octave. The filter is bypassed when [Thru] is selected.
8		Frequency	20 Hz to 20 kHz	Sets the HPF cutoff frequency.
9		Gc	-6 dB to +6 dB	Sets the cutoff frequency gain when the [Type] setting is [AdjustGc] (Adjustable Gc).

Delay

Click the Speaker Processor [Delay] button to open the window. Delay can be set independently for each output channel.

[Speaker Processor - Delay] editor window



	Parameter	Range	Function
1	Delay	ms: 0 to 500 Sample: the range depends on the Fs value. Meter: 0 to 171.8 Feet: 0 to 563.6 Frame: the range depends on the Frame value. Beat: the range depends on the Beat value.	Sets the delay time. Two edit boxes show milliseconds and the unit specified in the [Delay Scale] section. Sets the output level for each band.
2	On	ON/OFF	Turns delay ON.
3	Delay Scale	ms Sample Meter Feet Frame Beat	Selects the delay time units. The selected button will light and the [Delay] edit box will change accordingly. When [Beat] is selected the knobs can be used to adjust BPM.

NOTE

Delay Scale does not support the parameter link feature. Refer to "Parameter Link" on page 94 for information on parameter linking.

■ Parametric Equalizer

Click the Crossover Processor [PEQ] button to open the window. Parametric equalization is provided for each crossover band.

[Speaker Processor - PEQ] edit window



	Name		Function
1	Crossover response (phase)		Shows crossover phase response.
2	Crossover response (level)		Shows crossover level response.
	Parameter	Range	Function
3	Type	PEQ L.SHELF 6dB/Oct L.SHELF 12dB/Oct H.SHELF 6dB/Oct H.SHELF 12dB/Oct HPF LPF APF*1 1st APF*1 2nd Horn EQ*2	Select a filter type from the menu.
4	B/W	0.023 ~ 6.672	Sets the octave bandwidth for each band.
5	Q	63.0 ~ 0.10	Sets the Q for each band.
6	Frequency	20 Hz to 20 kHz	Sets the frequency for each band.
7	Gain	-18 dB to +18 dB	Sets the gain for each band.
8	Bypass	ON/OFF	Bypasses the PEQ for each band.
9	PEQ On	ON/OFF	Turns PEQ ON.

*1 APF: The APF (All Pass Filter) is a filter that passes all frequency bands while affecting only the phase. This is mainly used to correct the phase at the crossover band.

APF 1st will invert the phase at the specified frequency by 90° and for entire frequency bands by 0°–180°, while APF 2nd will invert the phase at the specified frequency by 180° and for entire frequency bands by 0°–360°. For APF 2nd, you can adjust the Q setting.

*2 Horn EQ: CD (Constant Directivity) horn speakers exhibit a roll-off in high-frequency level.

Horn EQ is provided to compensate for this roll-off. For this reason the gain can only be set to higher than 0dB, and the frequency higher than 500Hz.

■ Limiter

Click the Speaker Processor [Limiter] button to open the window. Limiter settings are provided for each output channel.

[Speaker Processor - Limiter] Editor Window

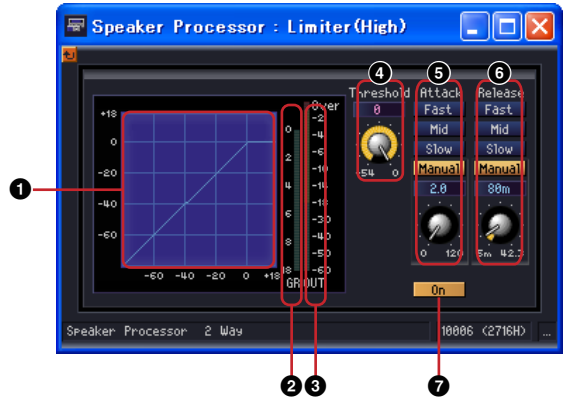

Name		Function	
1	Limiter Curve	A graphic representation of limiter response. The horizontal axis represents input level, and the vertical axis represents output level.	
2	Gain Reduction Meter	Displays the amount of gain reduction.	
3	Output Meter	Displays the output level.	
Parameter	Range	Function	
4	Threshold	-54 dB to ±0 dB	Sets the threshold level.
5	Attack	Fast Mid Slow Manual (0 to 120ms)	Selects the attack speed of the limiter. If the Manual setting is selected, specify the attack time in msec units. If Fast/Mid/Slow is selected, the attack time is specified roughly according to the HPF cutoff frequency of Speaker Processor's Crossover. Fast : 1/4 wavelength of cutoff frequency Mid : 1/2 wavelength of cutoff frequency Slow : 1 wavelength of cutoff frequency
6	Release	Fast Mid Slow Manual (44.1kHz: 6ms to 46s 48kHz: 5ms to 42.3s 88.2kHz: 3ms to 23s 96kHz: 3ms to 21.1s)	Selects the release speed of the limiter. If the Manual setting is selected, specify the release time in msec. If Fast/Mid/Slow is selected, the release time is specified roughly according to the HPF cutoff frequency of Speaker Processor's Crossover. Fast : 4 wavelength of cutoff frequency Mid : 8 wavelength of cutoff frequency Slow : 16 wavelength of cutoff frequency
7	On	ON/OFF	Turns the limiter ON. The limiter is bypassed when the button is turned OFF.

SPX

SPX is an effect component that supports many different effect applications, such as reverb, delay, and modulation effects, along with complex combinations of multiple effects. Although the SPX component is a single component, it encompasses 43 effect types.

When you change the effect type, right-click the SPX component to display the context menu, click [Recall Component Library], then select the effect type from the [Effect Type] submenu.

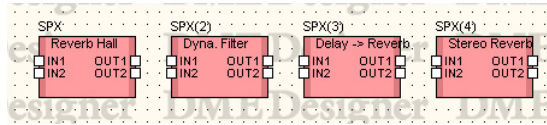

Double-click this component to display the component editor for it.

SPX component editor

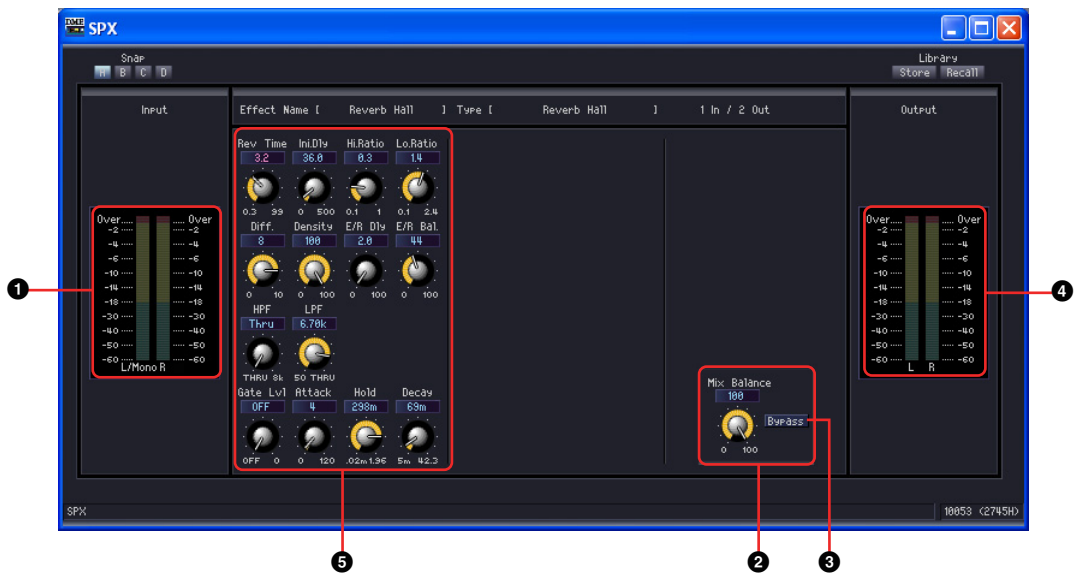

	Name/Parameter	Function
1	Input Meter	Displays the input signal level.
2	[Mix Balance] Control	Adjusts the balance between the fundamental tone and the effect tone.
3	[Bypass] button	When turned ON, the input signal is output without change.
4	Output Meter	Displays the output signal level.
5	Other Parameters	Other parameters vary according to the effect type.

Other effect parameters vary according to the selected effect type, as shown below.

Effect Type	Parameter	Setting Range	Function
Reverb Hall Reverb Room Reverb Stage Reverb Plate One input, two output hall, room, stage, and plate reverb simulations, all with gates.	Rev Time	0.3 to 99.0 s	Reverb time
	Ini.Dly	0.0 to 500.0 ms	Initial delay before reverb begins
	Hi.Ratio	0.1 to 1.0	High-frequency reverb time ratio
	Lo.Ratio	0.1 to 2.4	Low-frequency reverb time ratio
	Diff.	0 to 10	Reverb diffusion (left-right reverb spread)
	Density	0 to 100%	Reverb density
	E/R Dly	0.0 to 100.0 ms	Delay between early reflections and reverb
	E/R Bal.	0 to 100%	Balance of early reflections and reverb (0% = all reverb, 100% = all early reflections)
	HPF	THRU, 21.2 Hz to 8.00 kHz	High-pass filter cutoff frequency
	LPF	50.0 Hz to 16.0 kHz, THRU	Low-pass filter cutoff frequency
	Gate Lvl	OFF, -60 to 0 dB	Level at which gate kicks in
	Attack	0 to 120 ms	Gate opening speed
	Hold	44.1kHz: 0.02ms to 2.13s 48kHz: 0.02 ms to 1.96s 88.2kHz: 0.01ms to 1.06s 96kHz: 0.01ms to 981ms	Gate open time
	Decay	44.1kHz: 6.0ms to 46.0s 48kHz: 5.0ms to 42.3s 88.2kHz: 3ms to 23.0s 96kHz: 3ms to 21.1s	Gate closing speed
Early Ref. One input, two output early reflections.	Type	S-Hall, L-Hall, Random, Revers, Plate, Spring	Type of early reflection simulation
	RoomSize	0.1 to 20.0	Reflection spacing
	Liveness	0 to 10	Early reflections decay characteristics (0 = dead, 10 = live)
	Ini.Dly	0.0 to 500.0 ms	Initial delay before reverb begins
	Diff.	0 to 10	Reflection diffusion (left-right reflection spread)
	Density	0 to 100%	Reflection density
	ER Num.	1 to 19	Number of early reflections
	FB.Gain	-99 to +99%	Feedback gain
	Hi.Ratio	0.1 to 1.0	High-frequency feedback ratio
	HPF	THRU, 21.2 Hz to 8.00 kHz	High-pass filter cutoff frequency
	LPF	50.0 Hz to 16.0 kHz, THRU	Low-pass filter cutoff frequency
Gate Reverb Reverse Gate One input, two output early reflections with gate, and early reflections with reverse gate.	Type	Type-A, Type-B	Type of early reflection simulation
	RoomSize	0.1 to 20.0	Reflection spacing
	Liveness	0 to 10	Early reflections decay characteristics (0 = dead, 10 = live)
	Ini.Dly	0.0 to 500.0 ms	Initial delay before reverb begins
	Diff.	0 to 10	Reflection diffusion (left-right reflection spread)
	Density	0 to 100%	Reflection density
	ER Num.	1 to 19	Number of early reflections
	FB.Gain	-99 to +99%	Feedback gain
	Hi.Ratio	0.1 to 1.0	High-frequency feedback ratio
	HPF	THRU, 21.2 Hz to 8.00 kHz	High-pass filter cutoff frequency
	LPF	50.0 Hz to 16.0 kHz, THRU	Low-pass filter cutoff frequency
Mono Delay One input, one output basic repeat delay.	Delay	0.0 to 2730.0 ms	Delay time
	FB.Gain	-99 to +99%	Feedback gain (plus values for normal-phase feedback, minus values for reverse-phase feedback)
	Hi.Ratio	0.1 to 1.0	High-frequency feedback ratio
	HPF	THRU, 21.2 Hz to 8.00 kHz	High-pass filter cutoff frequency
	LPF	50.0 Hz to 16.0 kHz, THRU	Low-pass filter cutoff frequency

Effect Type	Parameter	Setting Range	Function
Stereo Delay Two input, two output basic stereo delay.	Delay L	0.0 to 1350.0 ms	Left channel delay time
	Delay R	0.0 to 1350.0 ms	Right channel delay time
	FB.Gain L	-99 to +99%	Left channel feedback (plus values for normal-phase feedback, minus values for reverse-phase feedback)
	FB.Gain R	-99 to +99%	Right channel feedback (plus values for normal-phase feedback, minus values for reverse-phase feedback)
	Hi.Ratio	0.1 to 1.0	High-frequency feedback ratio
	HPF	THRU, 21.2 Hz to 8.00 kHz	High-pass filter cutoff frequency
	LPF	50.0 Hz to 16.0 kHz, THRU	Low-pass filter cutoff frequency
Mod.Delay One input, two output basic repeat delay with modulation.	Delay	0.0 to 2725.0 ms	Delay time
	FB.Gain	-99 to +99%	Feedback gain (plus values for normal-phase feedback, minus values for reverse-phase feedback)
	Hi.Ratio	0.1 to 1.0	High-frequency feedback ratio
	Freq.	0.05 to 40.00 Hz	Modulation speed
	Depth	0 to 100%	Modulation depth
	Wave	Sine, Tri	Modulation waveform
	HPF	THRU, 21.2 Hz to 8.00 kHz	High-pass filter cutoff frequency
	LPF	50.0 Hz to 16.0 kHz, THRU	Low-pass filter cutoff frequency
Delay LCR One input, two output 3-tap delay (left, center, right).	Delay L	0.0 to 2730.0 ms	Left channel delay time
	Delay C	0.0 to 2730.0 ms	Center channel delay time
	Delay R	0.0 to 2730.0 ms	Right channel delay time
	Delay FB	0.0 to 2730.0 ms	Feedback delay time
	Level L	-100 to +100%	Left channel delay level
	Level C	-100 to +100%	Center channel delay level
	Level R	-100 to +100%	Right channel delay level
	FB.Gain	-99 to +99%	Feedback gain (plus values for normal-phase feedback, minus values for reverse-phase feedback)
	Hi.Ratio	0.1 to 1.0	High-frequency feedback ratio
	HPF	THRU, 21.2 Hz to 8.00 kHz	High-pass filter cutoff frequency
	LPF	50.0 Hz to 16.0 kHz, THRU	Low-pass filter cutoff frequency
	Echo Two input, two output stereo delay with crossed feedback loop.	Delay L	0.0 to 1350.0 ms
Delay R		0.0 to 1350.0 ms	Right channel delay time
FB.Dly L		0.0 to 1350.0 ms	Left channel feedback delay time
FB.Dly R		0.0 to 1350.0 ms	Right channel feedback delay time
FB.Gain L		-99 to +99%	Left channel feedback gain (plus values for normal-phase feedback, minus values for reverse-phase feedback)
FB.Gain R		-99 to +99%	Right channel feedback gain (plus values for normal-phase feedback, minus values for reverse-phase feedback)
L->R FBG		-99 to +99%	Left to right channel feedback gain (plus values for normal-phase feedback, minus values for reverse-phase feedback)
R->L FBG		-99 to +99%	Right to left channel feedback gain (plus values for normal-phase feedback, minus values for reverse-phase feedback)
Hi.Ratio		0.1 to 1.0	High-frequency feedback ratio
HPF		THRU, 21.2 Hz to 8.00 kHz	High-pass filter cutoff frequency
LPF		50.0 Hz to 16.0 kHz, THRU	Low-pass filter cutoff frequency

Effect Type	Parameter	Setting Range	Function	
Chorus Two input, two output chorus effect.	Freq.	0.05 to 40.00 Hz	Modulation speed	
	AM.Depth	0 to 100%	Amplitude modulation depth	
	PM.Depth	0 to 100%	Pitch modulation depth	
	Mod.Dly	0.0 to 500.0 ms	Modulation delay time	
	Wave	Sine, Tri	Modulation waveform	
	LSH F	21.2 Hz to 8.00 kHz	Low shelving filter frequency	
	LSH G	-12 to +12 dB	Low shelving filter gain	
	EQ F	100 Hz to 8.00 kHz	EQ (peaking type) frequency	
	EQ G	-12 to +12 dB	EQ (peaking type) gain	
	EQ Q	10.0 to 0.10	EQ (peaking type) bandwidth	
	HSH F	50.0 Hz to 16.0 kHz	High shelving filter frequency	
	HSH G	-12 to +12 dB	High shelving filter gain	
Flange Two input, two output flange effect.	Freq.	0.05 to 40.00 Hz	Modulation speed	
	Depth	0 to 100%	Modulation depth	
	Mod.Dly	0.0 to 500.0 ms	Modulation delay time	
	FB.Gain	-99 to +99%	Feedback gain (plus values for normal-phase feedback, minus values for reverse-phase feedback)	
	Wave	Sine, Tri	Modulation waveform	
	LSH F	21.2 Hz to 8.00 kHz	Low shelving filter frequency	
	LSH G	-12 to +12 dB	Low shelving filter gain	
	EQ F	100 Hz to 8.00 kHz	EQ (peaking type) frequency	
	EQ G	-12 to +12 dB	EQ (peaking type) gain	
	EQ Q	10.0 to 0.10	EQ (peaking type) bandwidth	
	HSH F	50.0 Hz to 16.0 kHz	High shelving filter frequency	
	HSH G	-12 to +12 dB	High shelving filter gain	
Symphonic Two input, two output symphonic effect.	Freq.	0.05 to 40.00 Hz	Modulation speed	
	Depth	0 to 100%	Modulation depth	
	Mod.Dly	0.0 to 500.0 ms	Modulation delay time	
	Wave	Sine, Tri	Modulation waveform	
	LSH F	21.2 Hz to 8.00 kHz	Low shelving filter frequency	
	LSH G	-12 to +12 dB	Low shelving filter gain	
	EQ F	100 Hz to 8.00 kHz	EQ (peaking type) frequency	
	EQ G	-12 to +12 dB	EQ (peaking type) gain	
	EQ Q	10.0 to 0.10	EQ (peaking type) bandwidth	
	HSH F	50.0 Hz to 16.0 kHz	High shelving filter frequency	
	HSH G	-12 to +12 dB	High shelving filter gain	
	Phaser Two input, two output 16-stage phaser.	Freq.	0.05 to 40.00 Hz	Modulation speed
Depth		0 to 100%	Modulation depth	
FB.Gain		-99 to +99%	Feedback gain (plus values for normal-phase feedback, minus values for reverse-phase feedback)	
Offset		0 to 100	Lowest phase-shifted frequency offset	
PHASE		0.00 to 354.38 degrees	Left and right modulation phase balance	
Stage		2, 4, 6, 8, 10, 12, 14, 16	Number of phase shift stages	
LSH F		21.2 Hz to 8.00 kHz	Low shelving filter frequency	
LSH G		-12 to +12 dB	Low shelving filter gain	
HSH F		50.0 Hz to 16.0 kHz	High shelving filter frequency	
HSH G		-12 to +12 dB	High shelving filter gain	
Auto Pan Two input, two output autopanner.		Freq.	0.05 to 40.00 Hz	Modulation speed
		Depth	0 to 100%	Modulation depth
	Direction	L<->R, L->R, L<-R, Turn L, Turn R	Panning direction	
	Wave	Sine, Tri, Square	Modulation waveform	
	LSH F	21.2 Hz to 8.00 kHz	Low shelving filter frequency	
	LSH G	-12 to +12 dB	Low shelving filter gain	
	EQ F	100 Hz to 8.00 kHz	EQ (peaking type) frequency	
	EQ G	-12 to +12 dB	EQ (peaking type) gain	
	EQ Q	10.0 to 0.10	EQ (peaking type) bandwidth	
	HSH F	50.0 Hz to 16.0 kHz	High shelving filter frequency	
	HSH G	-12 to +12 dB	High shelving filter gain	

Effect Type	Parameter	Setting Range	Function
Tremolo Two input, two output tremolo effect.	Freq.	0.05 to 40.00 Hz	Modulation speed
	Depth	0 to 100%	Modulation depth
	Wave	Sine, Tri, Square	Modulation waveform
	LSH F	21.2 Hz to 8.00 kHz	Low shelving filter frequency
	LSH G	-12 to +12 dB	Low shelving filter gain
	EQ F	100 Hz to 8.00 kHz	EQ (peaking type) frequency
	EQ G	-12 to +12 dB	EQ (peaking type) gain
	EQ Q	10.0 to 0.10	EQ (peaking type) bandwidth
	HSH F	50.0 Hz to 16.0 kHz	High shelving filter frequency
	HSH G	-12 to +12 dB	High shelving filter gain
HQ.Pitch One input, two output high-quality pitch shifter.	Pitch	-12 to +12 semitones	Pitch shift
	Fine	-50 to +50 cents	Pitch shift fine
	Delay	0.0 to 1000.0 ms	Delay time
	FB.Gain	-99 to +99%	Feedback gain (plus values for normal-phase feedback, minus values for reverse-phase feedback)
	Mode	1 to 10	Pitch shift precision
Dual Pitch Two input, two output pitch shifter.	Pitch 1	-24 to +24 semitones	Channel #1 pitch shift
	Fine 1	-50 to +50 cents	Channel #1 pitch shift fine
	Pitch 2	-24 to +24 semitones	Channel #2 pitch shift
	Fine 2	-50 to +50 cents	Channel #2 pitch shift fine
	Level 1	-100 to +100%	Channel #1 level (plus values for normal phase, minus values for reverse phase)
	Pan 1	L63 to R63	Channel #1 pan
	Level 2	-100 to +100%	Channel #2 level (plus values for normal phase, minus values for reverse phase)
	Pan 2	L63 to R63	Channel #2 pan
	Delay 1	0.0 to 1000.0 ms	Channel #1 delay time
	FB.Gain 1	-99 to +99%	Channel #1 feedback gain (plus values for normal-phase feedback, minus values for reverse-phase feedback)
	Delay 2	0.0 to 1000.0 ms	Channel #2 delay time
	FB.Gain 2	-99 to +99%	Channel #2 feedback gain (plus values for normal-phase feedback, minus values for reverse-phase feedback)
	Mode	1 to 10	Pitch shift precision
Rotary One input, two output rotary speaker simulator.	Rotate	STOP, START	Rotation stop, start
	Speed	SLOW, FAST	Rotation speed (see SLOW and FAST parameters)
	Slow	0.05 to 10.00 Hz	SLOW rotation speed
	Fast	0.05 to 10.00 Hz	FAST rotation speed
	Drive	0 to 100	Overdrive level
	Accel	0 to 10	Acceleration at speed changes
	Low	0 to 100	Low-frequency filter
	High	0 to 100	High-frequency filter
Ring Mod. Two input, two output ring modulator.	Source	OSC, SELF	Modulation source: oscillator or input signal
	Osc.Freq.	0.0 to 5000.0 Hz	Oscillator frequency
	FM Freq.	0.05 to 40.00 Hz	Oscillator frequency modulation speed
	FM Depth	0 to 100%	Oscillator frequency modulation depth
Mod.Filter Two input, two output modulation filter.	Freq.	0.05 to 40.00 Hz	Modulation speed
	Depth	0 to 100%	Modulation depth
	Phase	0.00 to 354.38 degrees	Left-channel modulation and right-channel modulation phase difference
	Type	LPF, HPF, BPF	Filter type: low pass, high pass, band pass
	Offset	0 to 100	Filter frequency offset
	Reso.	0 to 20	Filter resonance
	Level	0 to 100	Output level
Distortion One input, two output distortion effect.	DST.Type	DST1, DST2, OVD1, OVD2, CRUNCH	Distortion type (DST = distortion, OVD = overdrive)
	Drive	0 to 100	Distortion drive
	Master	0 to 100	Master volume
	N.Gate	0 to 20	Noise reduction

Effect Type	Parameter	Setting Range	Function
Amp Simulate One input, two output guitar amp simulator.	AMP.Type	STK-M1, STK-M2, THRASH, MIDBST, CMB-PG, CMB-VR, CMB-DX, CMB-TW, MINI, FLAT	Guitar amp simulation type
	DST.Type	DST1, DST2, OVD1, OVD2, CRUNCH	Distortion type (DST = distortion, OVD = overdrive)
	Drive	0 to 100	Distortion drive
	Master	0 to 100	Master volume
	Bass	0 to 100	Bass tone control
	Middle	0 to 100	Middle tone control
	Treble	0 to 100	High tone control
	Cab Dep	0 to 100%	Speaker cabinet simulation depth
	EQ F	100 to 8.0 kHz	EQ (peaking type) frequency
	EQ G	-12 to +12 dB	EQ (peaking type) gain
	EQ Q	10.0 to 0.10	EQ (peaking type) bandwidth
	N.Gate	0 to 20	Noise reduction
Dyna.Filter Two input, two output dynamically controlled filter.	Sense	0 to 100	Sensitivity
	Direction	UP, DOWN	Upward or downward frequency change
	Decay	44.1kHz: 6.0ms to 46.0s 48kHz: 5.0ms to 42.3s 88.2kHz: 3ms to 23.0s 96kHz: 3ms to 21.1s	Filter frequency change decay speed
	Type	LPF, HPF, BPF	Filter type
	Offset	0 to 100	Filter frequency offset
	Reso.	0 to 20	Filter resonance
	Level	0 to 100	Output Level
Dyna.Flange Two input, two output dynamically controlled flanger.	Sense	0 to 100	Sensitivity
	Direction	UP, DOWN	Upward or downward frequency change
	Decay	44.1kHz: 6.0ms to 46.0s 48kHz: 5.0ms to 42.3s 88.2kHz: 3ms to 23.0s 96kHz: 3ms to 21.1s	Decay speed
	Offset	0 to 100	Delay time offset
	FB.Gain	-99 to +99%	Feedback gain (plus values for normal-phase feedback, minus values for reverse-phase feedback)
	LSH F	21.2 Hz to 8.00 kHz	Low shelving filter frequency
	LSH G	-12 to +12 dB	Low shelving filter gain
	EQ F	100 Hz to 8.00 kHz	EQ (peaking type) frequency
	EQ G	-12 to +12 dB	EQ (peaking type) gain
	EQ Q	10.0 to 0.10	EQ (peaking type) bandwidth
	HSH F	50.0 Hz to 16.0 kHz	High shelving filter frequency
HSH G	-12 to +12 dB	High shelving filter gain	
Dyna.Phaser Two input, two output dynamically controlled phaser.	Sense	0 to 100	Sensitivity
	Direction	UP, DOWN	Upward or downward frequency change
	Decay	44.1kHz: 6.0ms to 46.0s 48kHz: 5.0ms to 42.3s 88.2kHz: 3ms to 23.0s 96kHz: 3ms to 21.1s	Decay speed
	Offset	0 to 100	Lowest phase-shifted frequency offset
	FB.Gain	-99 to +99%	Feedback gain (plus values for normal-phase feedback, minus values for reverse-phase feedback)
	Stage	2, 4, 6, 8, 10, 12, 14, 16	Number of phase shift stages
	LSH F	21.2 Hz to 8.00 kHz	Low shelving filter frequency
	LSH G	-12 to +12 dB	Low shelving filter gain
	HSH F	50.0 Hz to 16.0 kHz	High shelving filter frequency
	HSH G	-12 to +12 dB	High shelving filter gain

Effect Type	Parameter	Setting Range	Function
Rev+Chorus One input, two output reverb and chorus effects in parallel.	Rev Time	0.3 to 99.0 s	Reverb time
	Ini.Dly	0.0 to 500.0 ms	Initial delay before reverb begins
	Hi.Ratio	0.1 to 1.0	High-frequency reverb time ratio
	Diff.	0 to 10	Spread
	Density	0 to 100%	Reverb density
	HPF	THRU, 21.2 Hz to 8.00 kHz	High-pass filter cutoff frequency
	LPF	50.0 Hz to 16.0 kHz, THRU	Low-pass filter cutoff frequency
	Rev/Cho	0 to 100%	Reverb and chorus balance (0% = all reverb, 100% = all chorus)
	Freq.	0.05 to 40.00 Hz	Modulation speed
	AM.Depth	0 to 100%	Amplitude modulation depth
	PM.Depth	0 to 100%	Pitch modulation depth
	Mod.Dly	0.0 to 500.0 ms	Modulation delay time
	Wave	Sine, Tri	Modulation waveform
Rev->Chorus One input, two output reverb and chorus effects in series.	Rev Time	0.3 to 99.0 s	Reverb time
	Ini.Dly	0.0 to 500.0 ms	Initial delay before reverb begins
	Hi.Ratio	0.1 to 1.0	High-frequency reverb time ratio
	Diff.	0 to 10	Spread
	Density	0 to 100%	Reverb density
	HPF	THRU, 21.2 Hz to 8.00 kHz	High-pass filter cutoff frequency
	LPF	50.0 Hz to 16.0 kHz, THRU	Low-pass filter cutoff frequency
	Rev Bal.	0 to 100%	Reverb and chorused reverb balance (0% = all chorused reverb, 100% = all reverb)
	Freq.	0.05 to 40.00 Hz	Modulation speed
	AM.Depth	0 to 100%	Amplitude modulation depth
	PM.Depth	0 to 100%	Pitch modulation depth
	Mod.Dly	0.0 to 500.0 ms	Modulation delay time
	Wave	Sine, Tri	Modulation waveform
Rev+Flange One input, two output reverb and flanger effects in parallel.	Rev Time	0.3 to 99.0 s	Reverb time
	Ini.Dly	0.0 to 500.0 ms	Initial delay before reverb begins
	Hi.Ratio	0.1 to 1.0	High-frequency reverb time ratio
	Diff.	0 to 10	Spread
	Density	0 to 100%	Reverb density
	HPF	THRU, 21.2 Hz to 8.00 kHz	High-pass filter cutoff frequency
	LPF	50.0 Hz to 16.0 kHz, THRU	Low-pass filter cutoff frequency
	Rev/Flg	0 to 100%	Reverb and flange balance (0% = all reverb, 100% = all flange)
	Freq.	0.05 to 40.00 Hz	Modulation speed
	Depth	0 to 100%	Modulation depth
	Mod.Dly	0.0 to 500.0 ms	Modulation delay time
	FB.Gain	-99 to +99%	Feedback gain (plus values for normal-phase feedback, minus values for reverse-phase feedback)
	Wave	Sine, Tri	Modulation waveform
Rev->Flange One input, two output reverb and flanger effects in series.	Rev Time	0.3 to 99.0 s	Reverb time
	Ini.Dly	0.0 to 500.0 ms	Initial delay before reverb begins
	Hi.Ratio	0.1 to 1.0	High-frequency reverb time ratio
	Diff.	0 to 10	Spread
	Density	0 to 100%	Reverb density
	HPF	THRU, 21.2 Hz to 8.00 kHz	High-pass filter cutoff frequency
	LPF	50.0 Hz to 16.0 kHz, THRU	Low-pass filter cutoff frequency
	Rev Bal.	0 to 100%	Reverb and flanged reverb balance (0% = all flanged reverb, 100% = all reverb)
	Freq.	0.05 to 40.00 Hz	Modulation speed
	Depth	0 to 100%	Modulation depth
	Mod.Dly	0.0 to 500.0 ms	Modulation delay time
	FB.Gain	-99 to +99%	Feedback gain (plus values for normal-phase feedback, minus values for reverse-phase feedback)
	Wave	Sine, Tri	Modulation waveform

Effect Type	Parameter	Setting Range	Function
Rev+Sympho. One input, two output reverb and symphonic effects in parallel.	Rev Time	0.3 to 99.0 s	Reverb time
	Ini.Dly	0.0 to 500.0 ms	Initial delay before reverb begins
	Hi.Ratio	0.1 to 1.0	High-frequency reverb time ratio
	Diff.	0 to 10	Spread
	Density	0 to 100%	Reverb density
	HPF	THRU, 21.2 Hz to 8.00 kHz	High-pass filter cutoff frequency
	LPF	50.0 Hz to 16.0 kHz, THRU	Low-pass filter cutoff frequency
	Rev/Sym	0 to 100%	Reverb and symphonic balance (0% = all reverb, 100% = all symphonic)
	Freq.	0.05 to 40.00 Hz	Modulation speed
	Depth	0 to 100%	Modulation depth
	Mod.Dly	0.0 to 500.0 ms	Modulation delay time
	Wave	Sine, Tri	Modulation waveform
Rev->Sympho. One input, two output reverb and symphonic effects in series.	Rev Time	0.3 to 99.0 s	Reverb time
	Ini.Dly	0.0 to 500.0 ms	Initial delay before reverb begins
	Hi.Ratio	0.1 to 1.0	High-frequency reverb time ratio
	Diff.	0 to 10	Spread
	Density	0 to 100%	Reverb density
	HPF	THRU, 21.2 Hz to 8.00 kHz	High-pass filter cutoff frequency
	LPF	50.0 Hz to 16.0 kHz, THRU	Low-pass filter cutoff frequency
	Rev Bal.	0 to 100%	Reverb and symphonic reverb balance (0% = all symphonic reverb, 100% = all reverb)
	Freq.	0.05 to 40.00 Hz	Modulation speed
	Depth	0 to 100%	Modulation depth
	Mod.Dly	0.0 to 500.0 ms	Modulation delay time
	Wave	Sine, Tri	Modulation waveform
Rev->Pan One input, two output reverb and autopan effects in parallel.	Rev Time	0.3 to 99.0 s	Reverb time
	Ini.Dly	0.0 to 500.0 ms	Initial delay before reverb begins
	Hi.Ratio	0.1 to 1.0	High-frequency reverb time ratio
	Diff.	0 to 10	Spread
	Density	0 to 100%	Reverb density
	HPF	THRU, 21.2 Hz to 8.00 kHz	High-pass filter cutoff frequency
	LPF	50.0 Hz to 16.0 kHz, THRU	Low-pass filter cutoff frequency
	Rev Bal.	0 to 100%	Reverb and panned reverb balance (0% = all panned reverb, 100% = all reverb)
	Freq.	0.05 to 40.00 Hz	Modulation speed
	Depth	0 to 100%	Modulation depth
	Direction	L<->R, L->R, L<-R, Turn L, Turn R	Panning direction
	Wave	Sine, Tri, Square	Modulation waveform
Delay+ER. One input, two output delay and early reflections effects in parallel.	Delay L	0.0 to 1000.0 ms	Left channel delay time
	Delay R	0.0 to 1000.0 ms	Right channel delay time
	FB.Dly	0.0 to 1000.0 ms	Feedback delay time
	FB.Gain	-99 to +99%	Feedback gain (plus values for normal-phase feedback, minus values for reverse-phase feedback)
	Hi.Ratio	0.1 to 1.0	High-frequency feedback ratio
	HPF	THRU, 21.2 Hz to 8.00 kHz	High-pass filter cutoff frequency
	LPF	50.0 Hz to 16.0 kHz, THRU	Low-pass filter cutoff frequency
	Dly/ER	0 to 100%	Delay and early reflections balance (0% = all delay, 100% = all early reflections)
	Type	S-Hall, L-Hall, Random, Revers, Plate, Spring	Type of early reflection simulation
	RoomSize	0.1 to 20.0	Reflection spacing
	Liveness	0 to 10	Early reflections decay characteristics (0 = dead, 10 = live)
	Ini.Dly	0.0 to 500.0 ms	Initial delay before reverb begins
	Diff.	0 to 10	Spread
	Density	0 to 100%	Reverb density
ER Num.	1 to 19	Number of early reflections	

Effect Type	Parameter	Setting Range	Function
Delay->ER. One input, two output delay and early reflections effects in series.	Delay L	0.0 to 1000.0 ms	Left channel delay time
	Delay R	0.0 to 1000.0 ms	Right channel delay time
	FB.Dly	0.0 to 1000.0 ms	Feedback delay time
	FB.Gain	-99 to +99%	Feedback gain (plus values for normal-phase feedback, minus values for reverse-phase feedback)
	Hi.Ratio	0.1 to 1.0	High-frequency feedback ratio
	HPF	THRU, 21.2 Hz to 8.00 kHz	High-pass filter cutoff frequency
	LPF	50.0 Hz to 16.0 kHz, THRU	Low-pass filter cutoff frequency
	DLY.BAL	0 to 100%	Delay and early reflected delay balance (0% = all early reflected delay, 100% = all delay)
	Type	S-Hall, L-Hall, Random, Revers, Plate, Spring	Type of early reflection simulation
	RoomSize	0.1 to 20.0	Reflection spacing
	Liveness	0 to 10	Early reflections decay characteristics (0 = dead, 10 = live)
	Ini.Dly	0.0 to 500.0 ms	Initial delay before reverb begins
	Diff.	0 to 10	Spread
	Density	0 to 100%	Reverb density
ER Num.	1 to 19	Number of early reflections	
Delay+Reverb One input, two output delay and reverb effects in parallel.	Delay L	0.0 to 1000.0 ms	Left channel delay time
	Delay R	0.0 to 1000.0 ms	Right channel delay time
	FB.Dly	0.0 to 1000.0 ms	Feedback delay time
	FB.Gain	-99 to +99%	Feedback gain (plus values for normal-phase feedback, minus values for reverse-phase feedback)
	Delay Hi	0.1 to 1.0	Delay high-frequency feedback ratio
	HPF	THRU, 21.2 Hz to 8.00 kHz	High-pass filter cutoff frequency
	LPF	50.0 Hz to 16.0 kHz, THRU	Low-pass filter cutoff frequency
	Dly/Rev	0 to 100%	Delay and reverb balance (0% = all delay, 100% = all reverb)
	Rev Time	0.3 to 99.0 s	Reverb time
	Ini.Dly	0.0 to 500.0 ms	Initial delay before reverb begins
	Rev Hi	0.1 to 1.0	High-frequency reverb time ratio
	Diff.	0 to 10	Spread
	Density	0 to 100%	Reverb density
	Delay->Reverb One input, two output delay and reverb effects in series.	Delay L	0.0 to 1000.0 ms
Delay R		0.0 to 1000.0 ms	Right channel delay time
FB.Dly		0.0 to 1000.0 ms	Feedback delay time
FB.Gain		-99 to +99%	Feedback gain (plus values for normal-phase feedback, minus values for reverse-phase feedback)
Delay Hi		0.1 to 1.0	Delay high-frequency feedback ratio
HPF		THRU, 21.2 Hz to 8.00 kHz	High-pass filter cutoff frequency
LPF		50.0 Hz to 16.0 kHz, THRU	Low-pass filter cutoff frequency
Dly.Bal		0 to 100%	Delay and delayed reverb balance (0% = all delayed reverb, 100% = all delay)
Rev Time		0.3 to 99.0 s	Reverb time
Ini.Dly		0.0 to 500.0 ms	Initial delay before reverb begins
Rev Hi		0.1 to 1.0	High-frequency reverb time ratio
Diff.		0 to 10	Spread
Density		0 to 100%	Reverb density

Effect Type	Parameter	Setting Range	Function
Dist->Delay One input, two output distortion and delay effects in series.	DST.Type	DST1, DST2, OVD1, OVD2, CRUNCH	Distortion type (DST = distortion, OVD = overdrive)
	Drive	0 to 100	Distortion drive
	Master	0 to 100	Master volume
	Tone	-10 to +10	Tone control
	N.Gate	0 to 20	Noise reduction
	Delay	0.0 to 2725.0 ms	Delay time
	FB.Gain	-99 to +99%	Feedback gain (plus values for normal-phase feedback, minus values for reverse-phase feedback)
	Hi.Ratio	0.1 to 1.0	High-frequency feedback ratio
	Freq.	0.05 to 40.00 Hz	Modulation speed
	Depth	0 to 100%	Modulation depth
Multi.Filter Two input, two output 3-band multi-filter (24 dB/octave).	Type 1	HPF, LPF, BPF	Filter 1 type: high pass, low pass, band pass
	Type 2	HPF, LPF, BPF	Filter 2 type: high pass, low pass, band pass
	Type 3	HPF, LPF, BPF	Filter 3 type: high pass, low pass, band pass
	Freq. 1	28.0 Hz to 16.0 kHz	Filter 1 frequency
	Freq. 2	28.0 Hz to 16.0 kHz	Filter 2 frequency
	Freq. 3	28.0 Hz to 16.0 kHz	Filter 3 frequency
	Level 1	0 to 100	Filter 1 level
	Level 2	0 to 100	Filter 2 level
	Level 3	0 to 100	Filter 3 level
	Reso. 1	0 to 20	Filter 1 resonance
	Reso. 2	0 to 20	Filter 2 resonance
	Reso. 3	0 to 20	Filter 3 resonance
	Stereo Reverb Two input, two output stereo reverb.	Rev Time	0.3 to 99.0 s
Rev Type		Hall, Room, Stage, Plate	Reverb type
Ini.Dly		0.0 to 100.0 ms	Initial delay before reverb begins
Hi.Ratio		0.1 to 1.0	High-frequency reverb time ratio
Lo.Ratio		0.1 to 2.4	Low-frequency reverb time ratio
Diff.		0 to 10	Reverb diffusion (left-right reverb spread)
Density		0 to 100%	Reverb density
E/R Bal.		0 to 100%	Balance of early reflections and reverb (0% = all reverb, 100% = all early reflections)
HPF		THRU, 21.2 Hz to 8.00 kHz	High-pass filter cutoff frequency
LPF	50.0 Hz to 16.0 kHz, THRU	Low-pass filter cutoff frequency	

Effect Type	Parameter	Setting Range	Function
M.Band Dyna. Two input, two output 3-band dynamics processor, with individual solo and gain reduction metering for each band.	Low Gain	-96.0 to +12.0 dB	Low band level
	Mid Gain	-96.0 to +12.0 dB	Mid band level
	Hi. Gain	-96.0 to +12.0 dB	High band level
	Presence	-10 to +10	For positive values, the threshold of the high band is lowered and the threshold of the low band is increased. For negative values, the opposite will occur. When set to 0, all three bands are affected the same.
	Cmp.Thre	-24.0 dB to 0.0 dB	Compressor threshold
	Cmp.Rat	1:1 to 20:1	Compressor ratio
	Cmp.Atk	0 to 120 ms	Compressor attack
	Cmp.Rel	44.1kHz: 6.0ms to 46.0s 48kHz: 5.0ms to 42.3s 88.2kHz: 3ms to 23.0s 96kHz: 3ms to 21.1s	Compressor release time
	Cmp.Knee	0 to 5	Compressor knee
	Lookup	0.0 to 100.0 ms	Lookup delay
	Cmp.Byp	ON/OFF	Compressor bypass
	L-M XOver	21.2 Hz to 8.00 kHz	Low/mid crossover frequency
	M-H XOver	21.2 Hz to 8.00 kHz	Mid/high crossover frequency
	Slope	-6 dB, -12 dB	Filter slope
	Ceiling	-6.0 dB to 0.0 dB, OFF	Specifies the maximum output level
	Exp.Thre	-54.0 dB to -24.0 dB	Expander threshold
	Exp.Rat	1:1 to ∞:1	Expander ratio
	Exp.Rel	44.1kHz: 6.0ms to 46.0s 48kHz: 5.0ms to 42.3s 88.2kHz: 3ms to 23.0s 96kHz: 3ms to 21.1s	Expander release time
	Exp.Byp	ON/OFF	Expander bypass
	Lim.Thre	-12.0 dB to 0.0 dB	Limiter threshold
	Lim.Atk	0 to 120 ms	Limiter attack
	Lim.Rel	44.1kHz: 6.0ms to 46.0s 48kHz: 5.0ms to 42.3s 88.2kHz: 3ms to 23.0s 96kHz: 3ms to 21.1s	Limiter release time
	Lim.Byp	ON/OFF	Limiter bypass
	Lim.Knee	0 to 5	Limiter knee
Low	ON/OFF	Low band solo	
Mid	ON/OFF	Mid band solo	
High	ON/OFF	High band solo	

AEC – Acoustic Echo Cancellor (MY4-AEC card required)

This component is only available when an MY4-AEC Acoustic Echo Canceller is installed in a rear-panel I/O slot of the DME64N/24N.

To place the AEC component in a layout, select a DME64N or DME24N device, then select the MY4-AEC card via [Select I/O Card] in the “DME Device Properties” dialog box. (Page 218).

How Acoustic Echo and Noise are Reduced

Acoustic echo occurs in a teleconferencing system when the sound from a speaker or reflections from surfaces of the room are picked up by a microphone and transmitted to the other party, resulting in a loss of intelligibility. Projectors and air conditioning systems also produce noise that can interfere with clear teleconferencing. The echo canceling, noise reduction, and feedback suppressor capabilities of the MY4-AEC help to achieve maximum clarity and intelligibility for smooth, effective communication.

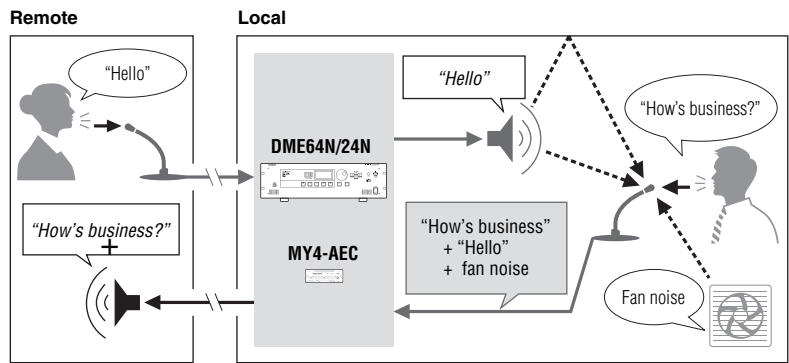

NOTE

In order to reduce acoustic echo originating from the remote location, an echo canceller must be installed and active at the remote location.

MY4-AEC Signal Flow

The local and remote locations in a teleconferencing system are referred to as the “near end” and “far end”, respectively. The MY4-AEC acoustic echo canceller (AEC) works by comparing the reference signal received from the far-end with the signal from the microphone in order to determine which components of the signal are echo, and then subtracts only the far-end echo component from microphone signal. The near-end sound is thus clearly transmitted to the far end without echo

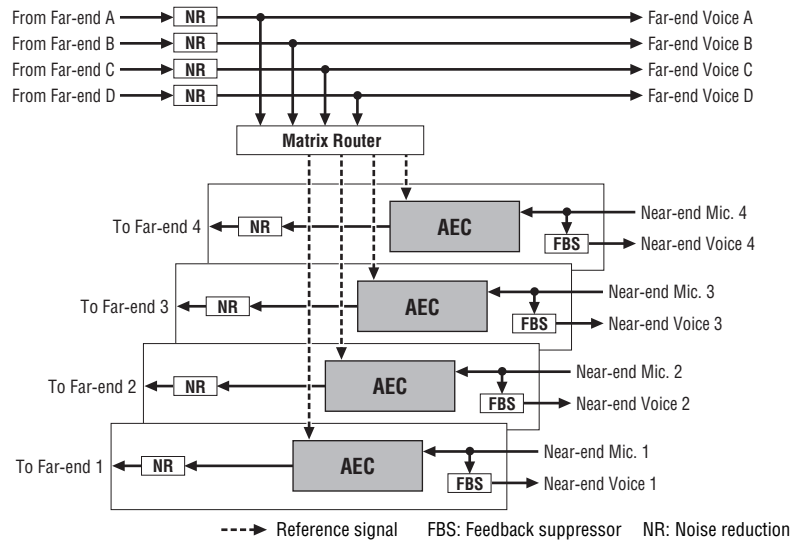

■ NR (Noise Reduction)

Automatically detects and reduces constant environmental noises such as projector fans or air conditioning.

■ FBS (Feedback Suppressor)

Automatically detects the frequencies at which feedback is occurring and applies notch filters at those frequencies to stop the feedback. 42 notch filters are available for each AEC channel. The notch filters are reset (i.e. returned to “not applied” status) when the DME64N/24N power is turned off.

■ AEC Component Editor

The AEC component editor includes meters that aid in setting optimum microphone levels and microphone/speaker positioning, as well as in adjusting for optimum echo cancellation effect.

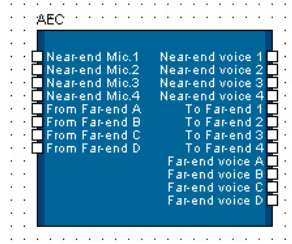

NOTE

The echo cancellation effect is disturbed due to off-balance of Mic. inputs and reference signals when the components which sounds are dynamically changed (ex. Dynamics and Auto Mixer) and the volumes which users control are inserted to the points where cross marks indicate in the right figure. To avoid these issues, the components above should be inserted to the points where circles indicate.

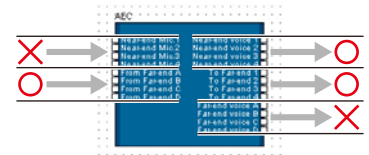

Double-click the component to open the component editor.

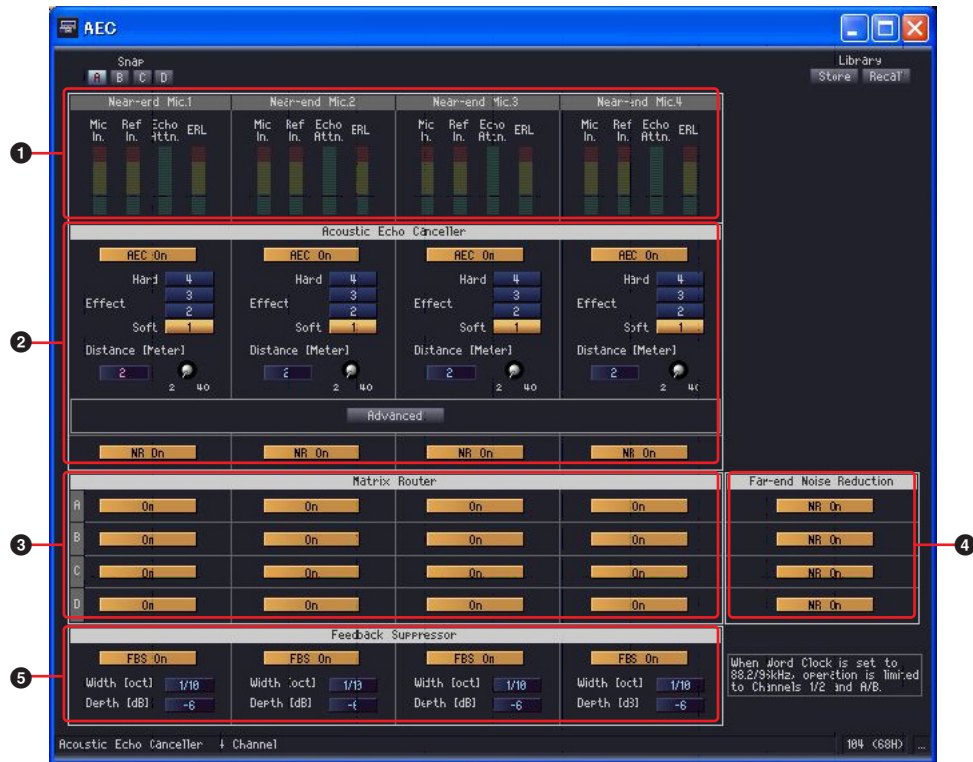

	Name		Function	
❶	Mic In. meters		These meters display the signal levels from the corresponding near-end microphones.	
	Ref In meters		Display the level of the far-end input signals that are used for AEC reference individually for each channel. Maintaining the reference signals at optimum levels leads to maximum echo cancellation efficacy.	
	Echo Attn. meters		Display the echo cancellation strength for each channel. The higher the level the stronger the echo cancellation effect.	
	ERL meters		Display the ERL (Echo Return Loss = the amount of speaker output that is picked up by the microphone) for each channel. Echo cancellation will be most effective if the microphone and speaker positions/orientations are adjusted so that this level is minimal.	
	Section	Parameter	Range	Function
❷	AEC	AEC On	ON/OFF	Turns the echo canceller function ON or OFF. When OFF, AEC “learning” will also stop.
		Effect	1, 2, 3, 4	Sets the strength of echo cancellation. Higher values correspond to higher echo cancellation strength. Higher values also result in reduced sound quality, so these settings should always be made while checking the sound.
		Distance	2 ~ 40 (meters)	Specifies the distance between the microphone and speaker used. If multiple microphones and speakers are used, the distance between closest microphone and speaker should be specified. If the microphone-to-speaker distance is less than 2 meters, use the 2 meter setting.
		Advanced button		Opens the Advanced Settings editor window (see page 486).
		NR On	ON/OFF	Turns the noise reduction function that automatically reduces constant environmental noises such as projector fans or air conditioning ON or OFF. These settings should normally be ON.
❸	Matrix Router		ON/OFF	Determines whether far-end input signals A~D will be used as reference signals for AEC channels 1~4.
❹	Far-end Noise Reduction		ON/OFF	These buttons individually turn noise reduction for far-end input channels A~D ON or OFF. These settings should normally be ON.
❺	Feedback Suppressor	FBS On	ON/OFF	Turn feedback suppression for the corresponding signal ON or OFF. Turning this function ON can prevent unwanted feedback that may occur when the near-end microphone input is being monitored via the local speaker system.
		Width	1/10, 1/60, 1/93 (oct)	Specifies the width of the notch filter that will be applied at the detected feedback frequency. This function makes it possible to reduce the bandwidth of the feedback suppressor notch filters when the filters begin to have noticeable negative impact on sound quality. A setting of “1/93” results in the narrowest notch filter bandwidth. Reducing bandwidth can also reduce the effectiveness of feedback suppression. The default setting is “1/10”.
		Depth	-6, -12, -18 (dB)	Specifies the attenuation of the notch filter that will be applied at the detected feedback frequency. A setting of “-18” results in the strongest feedback suppression, but this can also lead to a reduction in sound quality. The default setting is “-6”.

Advanced Settings Editor Window

Click the [Advanced] button in the AEC component editor window to open this window. The Advanced Settings editor window includes microphone settings for each AEC channel.

When a microphone with a PTT (Push To Talk) switch is used, a small amount of noise may be produced when the PTT switch is off. The AEC system may mistakenly “learn” the noise, resulting in an unwanted echo when the PTT switch is turned on and speech is resumed. This window includes settings that can prevent this type of problem, as well as specify how the microphones will be used.



	Parameter	Range	Function
1	PTT On	ON/OFF	When this button is turned ON and the microphone level is below the specified (3) PTT Threshold setting, the system determines that the PTT switch is ON and AEC “learning” is suspended. When the noise level is low or a microphone that does not have a PTT switch is used, this function can be turned OFF for improved learning performance.
2	Mic In. meters		Display the input levels from the near-end microphones (these meters perform the same functions as the Mic In. meters in the AEC component editor window). These meters can also be used to judge the level of noise being produced when the microphone PTT switch is OFF.
3	PTT Threshold	-80 ~ -20	Specifies the base level for AEC learning. When the (1) PTT On parameter is turned ON, AEC “learning” is suspended when the input to the near-end microphone falls below the specified threshold, and resumes when the threshold is exceeded. AEC learning will resume when the input level exceeds the specified threshold. The input signal level can be checked visually via the (2) Mic In. meters.
4	Mic. Type	Fixed, Moving	Specifies the way in which the connected microphone will be used. If the microphone is placed in a stand, for example, and the distance between it and the speakers will not change select “Fixed.” If the distance between the microphone and speaker will vary, select “Moving.” Depending on the environment, the “Moving” setting may result in optimum echo cancellation effect even when the microphone is fixed and, conversely, the “Fixed” setting can sometimes produce the best results with a hand-held microphone. Set this parameter for optimum results in your application.

Slot

■ Slot In

The Slot In Component only has outputs. 4, 8, and 16 channel types are provided.

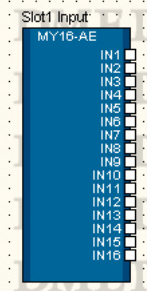

Either double-click the component, or select [Open Slot In Component Editor] from the contextual menu that appears when the component is right-clicked to open the component editor. The component editor is the same for all types.



	Name	Function
1	Meter	Shows the signal level for each channel.

Slot Out

The Slot Out component has only an input. There are three types of Slot In components: four-channel, eight-channel, and 16 channel types.

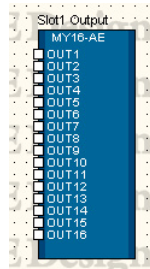

Either double-click the component, or select [Open Slot Out Component Editor] from the contextual menu that appears when the component is right-clicked to open the component editor.

Slot Out component editor



	Parameter	Setting Range	Function
1	Phase	ON/OFF	Reverses the phase of the output signal for each channel.
2	On	ON/OFF	Turns ON each channel's output.
3	Delay	0 to 24 Samples	Sets the delay time.
4	Level	-∞ to ±0 dB	Sets the output level.
5	Dither	Off 16 20 24	Sets the quantization bit rate for conversion.

Cascade (DME64N only)

Up to eight DME64N units can be cascade connected to provide bus sharing of up to 32 channels in order to distribute DSP resources and/or increase input/output capacity. If [Show Cascade port on Configuration Window] in the “DME Device Properties” dialog box is checked, Cascade I/O components will appear in the Configuration window. Refer to “When the DME64N Cascade Setting is Turned ON” (page 215), and to “‘Cascade Setting’ Dialog Box” (page 221) for further information.

NOTE

Be careful to avoid loop connections both when connecting via physical cables and in the Designer window.

■ Cascade In

Signals received from the CASCADE bus are assigned to the Cascade In component. Any cascade connected DME64N unit is capable of outputting the same signals. The meter displays the signal levels received at the rear-panel CASCADE IN terminal.

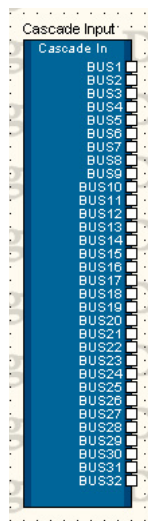

Right-click the component and select [Open Component Editor] from the contextual menu to open the component editor. The component editor is the same for all types.

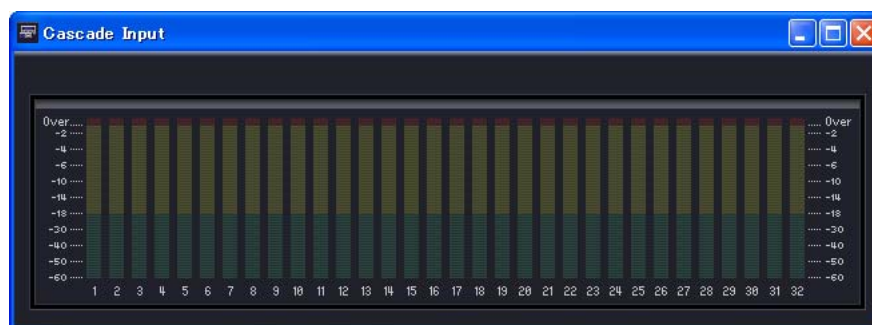

	Name	Function
1	Meter	Shows the signal level for each channel.

■ Cascade Out

Ports output to the CASCADE bus are assigned to the Cascade Out component. Make connections for signals to be output to the CASCADE bus here. Signals from multiple DME64N units input to the same channel are summed. The meter displays the signal levels being sent to the rear-panel CASCADE OUT terminal.

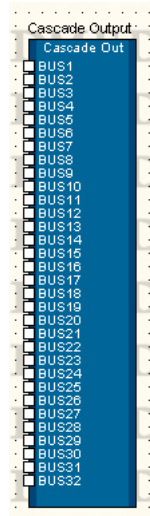

NOTE

When multiple DME64N units are cascade connected, each additional unit introduces a delay of a few samples that is automatically compensated for. This compensation is independent from the compensation within each unit.

Right-click the component and select [Open Component Editor] from the contextual menu to open the component editor. The component editor is the same for all types.

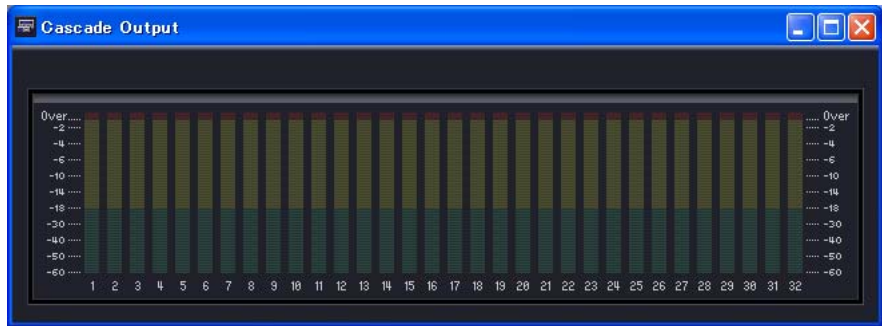

	Name	Function
1	Meter	Shows the signal level for each channel.

The following diagram shows an example in which three DME64N units are cascaded. Signal transmission and reception between cascade connected DME64N units is bidirectional. Using BUS 1, the signal from component 1 of DME64N #1 is distributed to DME64N #2 and DME64N #3. Using BUS 32, the signals from component 4 of DME64N #2 and component 6 of DME64N #3 are summed and returned to component 2 of DME64N #1.

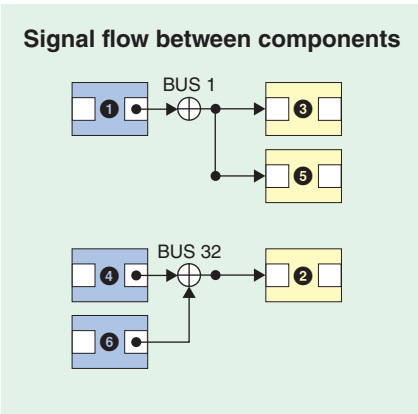
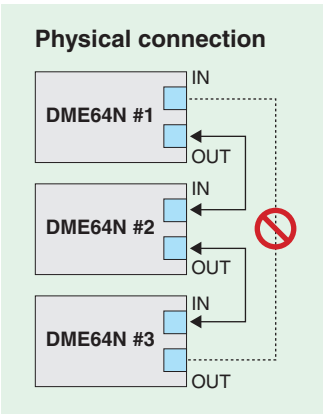
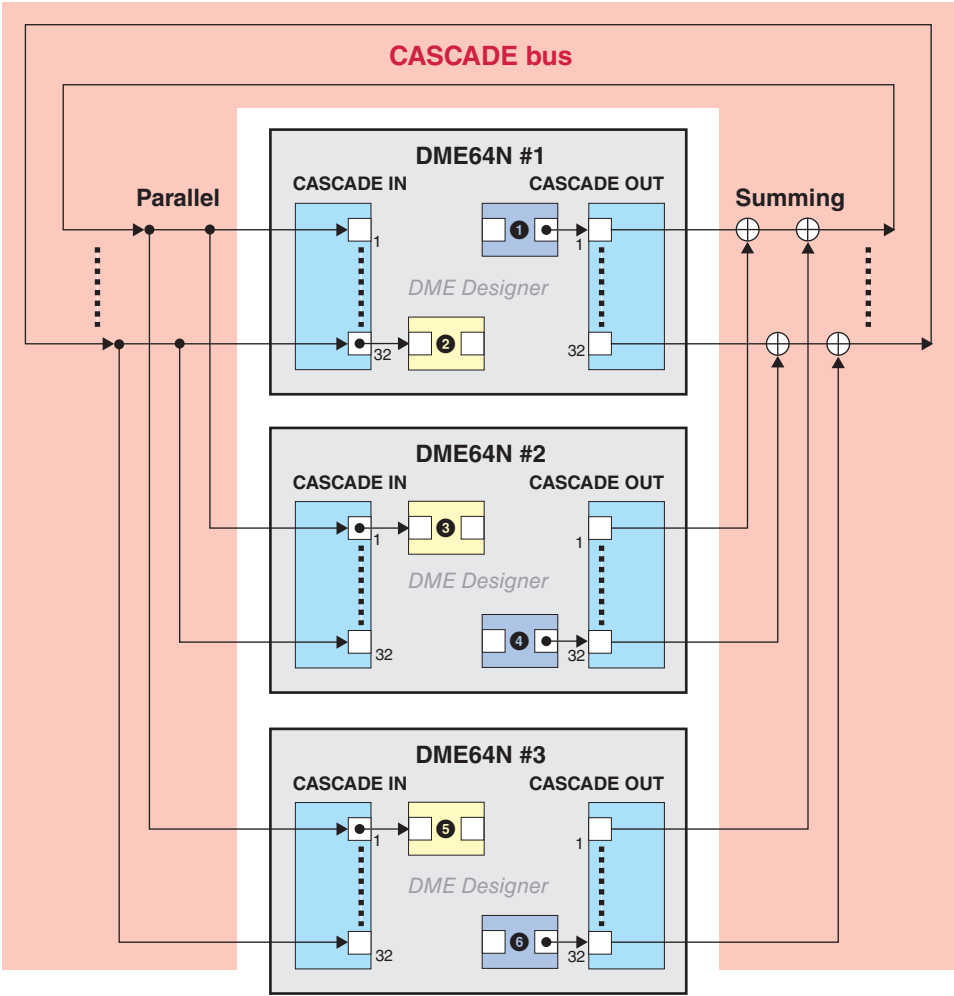

NOTE

Be careful to avoid loop connections both when connecting via physical cables and in the Designer window.

Analog Input and Output

In the DME24N/DME Satellite configuration window, there are [Analog Input] and [Analog Output] blocks.

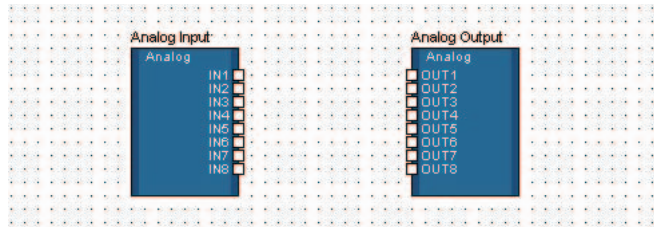

Analog Input

Right-click the component and select [Open HA Editor] from the contextual menu to open the editor.

NOTE

The DME24N, DME8i-C, DME4io-C, DME8i-ES and DME4io-ES have analog inputs. The DME24N, DME8i-C and DME8i-ES have eight analog inputs, while the DME4io-C and DME4io-ES have four.



Either double-click the component, or select [Open Input Component Editor] from the contextual menu that appears when the component is right-clicked to open the component editor.

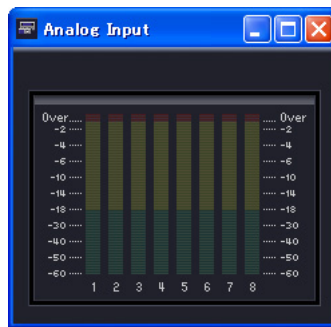

	Parameter	Setting Range	Function
1	+48	ON/OFF	Turns ON phantom power (+48V).
2	Gain	+10 to -60 dBu	Sets the rated input level.

Caution

- If you don't need phantom power, be sure to turn this button off.
- Before you turn phantom power on, make sure that no equipment other than phantom-powered devices such as condenser microphones are connected to that jack. Otherwise, you risk damaging your external equipment. Balanced dynamic microphones, however, will not be affected by phantom power.
- Do not connect or disconnect a device to [IN]/[INPUT] jacks while phantom power is applied. Doing so can damage the connected device and/or the unit itself.
- To protect your speaker system, leave the power amps (powered speakers) turned off when switching the phantom power on/off. We also recommend that you set all output levels to minimum. Otherwise, high-volume output may damage your hearing or equipment.

■ Analog Output

Double-click [Analog Output] to display the component editor for it. The displayed parameters are the same as for Slot Out component editor.

NOTE

The DME24N, DME8o-C, DME4io-C, DME8o-ES and DME4io-ES have analog outputs. The DME24N, DME8i-C and DME8o-ES have eight analog outputs, while the DME4io-C and DME4io-ES have four.

NOTE

To output signals at the same level at which they were input, set the Analog Input Gain to +4dBu, and the Analog Output Level to 0dB.

SP2060 Input and Output

The SP2060 configuration window includes [SP2060 Input] and [SP2060 Output] blocks.

■ SP2060 Input

Either double-click [SP2060 Input] or select [Open Component Editor] from the contextual menu that appears when the component is right-clicked to open the editor.

SP2060 Input Component Editor

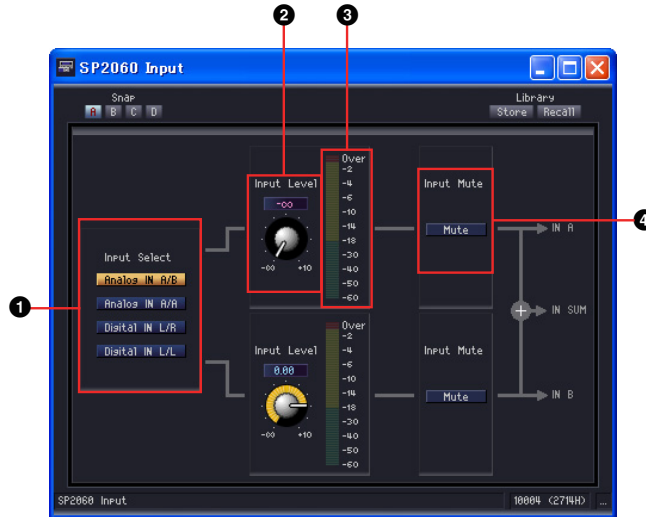

	Name/Parameter	Range	Function
❶	Input Select	Analog IN A/B Selects analog input channels A and B as the input signal sources. Analog IN A/A Selects analog input channel A as the source for both input signals. Digital IN L/R Selects digital input channels L and R as the input signal sources. Digital IN L/L Selects the digital L input channel as the source for both signals.	Selects the input signal(s).
❷	Input Level	-∞ ~ +10 dB	Set the input signal level for the corresponding input channel.
❸	Meter	-	Display the input signal level for the corresponding input channel.
❹	Mute	ON/OFF	Mute the input of the corresponding input channel.

CobraNet Input and Output

The DME8i-C/DME8o-C/DME4io-C configuration window includes [CobraNet Input] and [CobraNet Output] blocks.

■ CobraNet

Either double-click the block, or select [Open Input Component Editor] or [Open Output Component Editor] from the context menu that appears when the block is right-clicked to open the component editor. The displayed parameters are the same as for Slot In and Slot Out component editors.

Right-click the block and select [Open CobraNet Editor] from the contextual menu to open the editor.

CobraNet Input/Output Component Editor

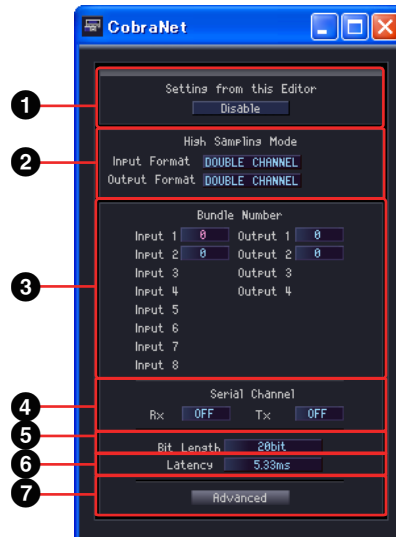

	Section	Name/Parameter	Range	Function
1		Setting from this Editor	Disable/Enable	When “Disable” is selected settings made via the CobraNet network take priority. When “Enable” is selected settings made from the DME Designer take priority.*
2	High Sampling Mode	Input Format	DOUBLE CHANNEL/ SINGLE	Selects the format for 88.2/96 kHz sampling rates. Linked to Output Format.
		Output Format	DOUBLE CHANNEL/ SINGLE	Selects the format for 88.2/96 kHz sampling rates. Linked to Input Format.
3	Bundle Number	Input	0 ~ 65279	Specifies the input bundle number.
		Output	0 ~ 65279	Specifies the output bundle number.
4	Serial Channel	Rx	OFF, 1 ~ 15	Specifies the serial receive channel.
		Tx	OFF, 1 ~ 15	Specifies the serial transmit channel.
5	Properties	Bit Length	Bit Off 16bit 20bit 24bit	Specifies the output bit rate. Output is muted when “Bit Off” is selected.
6		Latency	5.33ms 2.67ms 1.33ms	Specifies the latency.
7		Advanced	-	Opens the “Advanced Settings” window.

* Select “Disable” if you intend to make settings via the CobraNet network using the CobraNet Manager, for example. In such cases selecting “Enable” may result in incorrect settings.

NOTE

Refer to “DME8i-C/DME8o-C/DME4io-C Owner's Manual” for mote information on CobraNet.

“Advanced Settings” Window

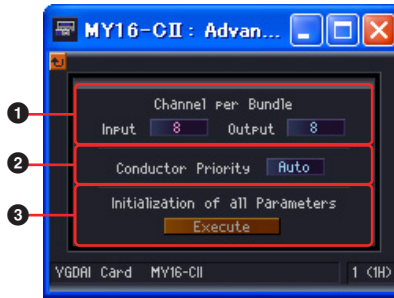

	Section	Name/Parameter	Range	Function
❶	Channel per Bundle	Input	1, 2, 4, 8	Specifies the number of channels per input bundle (*1).
		Output	1, 2, 4, 8	Specifies the number of channels per output bundle (*1).
❷	Conductor Priority		Auto 0 ~ 255	Sets the conductor priority.[255] is the highest priority. [Auto] means [32] on DME8i-C/DME8o-C/DME4io-C
❸	Initialization of All Parameters	Execute	-	Resets all settings to their default values. A confirmation dialog box will appear. Only available when online.(*2)

(*1) Fewer channels may be available, depending on the settings. Refer to the “MY16-CII Owner's Manual” or “DME8i-C/DME8o-C/DME4io-C Owner's Manual” for details.

(*2) All internal parameters will be set to factory presets as well as parameters that can be set via editor.

EtherSound Input and Output

The DME8i-ES/DME8o-ES/DME4io-ES configuration window includes [EtherSound Input] and [EtherSound Output] blocks.

■ EtherSound

Either double-click the block, or select [Open Input Component Editor] or [Open Output Component Editor] from the context menu that appears when the block is right-clicked to open the component editor. The displayed parameters are the same as for Slot In and Slot Out component editors.

Routing and other EtherSound settings cannot be made via EtherSound Input/Output components. Make EtherSound settings using the AVS-ESMonitor software available from Auvitrans.

MY-Card

This shows the input and output for the card inserted into the DME expansion slot. The following components are available, depending on the card types:

Input Format/Output Format

This is the I/O mode for high sample rate operation (88.2/96 kHz).

In the Double Channel Mode, high sampling rate data (88.2/96 kHz) is transmitted and received by two channels, each channel handling the digital audio data at half the sampling rate. For this reason the total number of available channels is halved, and even-numbered channels are unavailable.

In the Double Speed Mode digital audio data is transmitted and received at the current high sampling rate (88.2/96 kHz).

In the Single Mode digital audio data is transmitted and received at half the current high sampling rate (88.2/96 kHz).

Setting Examples

Operation clock of related equipment	The DME operation clock	Input Format/Output Format
88.2/96 kHz (Double Channel)	88.2/96 kHz	Double Channel
88.2/96 kHz (Double Speed)		Double Speed
44.1/48kHz		Single

When the MY card word clock is used as the master word clock, Double FS determines whether the speed of that word clock is to be doubled and used as the DME clock. The Double Fs setting is only available the word clock from an MY Card is used.

MY-Others

Right-click the block and select [Open MY-Card Editor] from the context menu to display the editor for it. This editor can be used for generic MY card editing, but some parameters are not available. Use a card specific editor when available.

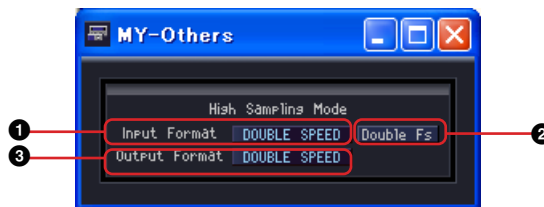

	Parameter	Setting Range	Function
1	Input Format	DOUBLE SPEED/ DOUBLE CHANNEL/ SINGLE	Selects the format for 88.2/96 kHz.
2	Double Fs	ON/OFF	When ON the speed of the word clock from the MY Card is doubled. Only displayed when this card is functioning as the word clock master.
3	Output Format	DOUBLE SPEED/ DOUBLE CHANNEL/ SINGLE	Selects the format for 88.2/96 kHz.

■ MY8-AE96S

Right-click the block and select [Open MY-Card Editor] from the context menu to display the editor for it.

MY8-AE96S component editor

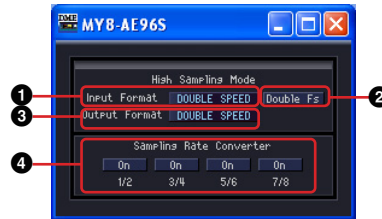

	Parameter	Setting Range	Function
❶	Input Format	DOUBLE SPEED/ DOUBLE CHANNEL	Selects the format for 88.2/96 kHz.
❷	Double Fs	ON/OFF	When ON the speed of the word clock from the MY Card is doubled. Only displayed when this card is functioning as the word clock master.
❸	Output Format	DOUBLE SPEED/ DOUBLE CHANNEL	Selects the format for 88.2/96 kHz.
❹	Sampling Rate Converter	ON/OFF	Turns the sampling rate converter ON.

■ MY16-AE/MY8-AE96/MY8-AE/MY8-AT/MY8-TD/MY16-TD/MY16-AT

Right-click the block and select [Open MY-Card Editor] from the context menu to display the editor for it.

Example: MY16-AE component editor

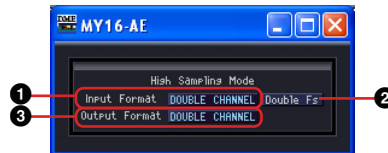

	Parameter	Setting Range	Function
❶	Input Format	DOUBLE SPEED/ DOUBLE CHANNEL/ SINGLE	Selects the format for 88.2/96 kHz. For MY8-AE96, the setting range is Double Speed/Double Channel. For other cards, it is Double Channel/Single.
❷	Double Fs	ON/OFF	When ON the speed of the word clock from the MY Card is doubled. Only for MY16-AE/MY8-AE96/MY16-TD. When On is set for the MY8-AE96, the Input Format is Double Channel. When Off is set, the input format is Double Speed. Only displayed when this card is functioning as the word clock master.
❸	Output Format	DOUBLE SPEED/ DOUBLE CHANNEL/ SINGLE	Selects the format for 88.2/96 kHz. For MY8-AE96, the setting range is Double Speed/Double Channel. For other cards, it is Double Channel/Single.

MY16-C

Right-click the block and select [Open MY-Card Editor] from the context menu to display the editor for it.

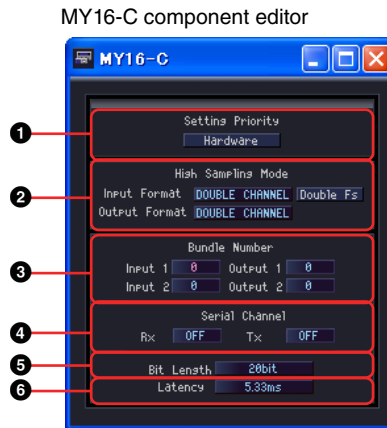

	Section	Parameter	Setting Range	Function
1	Setting Priority	Setting Priority	Hardware/ Software	The MY16-C switch settings take priority when “Hardware” is selected, and the DME Designer settings take priority when “Software” is selected.
2	High Sampling Mode	Input Format	DOUBLE CHANNEL/ SINGLE	Selects the format for 88.2/96 kHz sampling rates. Linked to Output Format.
		Double FS	ON/OFF	When turned ON the speed of the MY card word clock output is doubled. Only available when the card is set as the word clock master.
		Output Format	DOUBLE CHANNEL/ SINGLE	Selects the format for 88.2/96 kHz sampling rates. Linked to Input Format.
3	Bundle Number	Input	0 to 65279	Sets the input bundle number.
		Output	0 to 65279	Sets the output bundle number.
4	Serial Channel	Rx	OFF, 1 - 16	Sets the serial channel for the receive side.
		Tx	OFF, 1 - 16	Sets the serial channel for the send side.
5	Properties	Bit Length	Bit Off 16 bit 20 bit 24 bit	Sets the bit rate for output. Mutes the signal if [Bit Off] is set.
6		Latency	5.33 ms 2.67 ms 1.33 ms	Sets the delay.

NOTE

The parameters will not link immediately when Setting Priority is switched. Please edit another parameter after switching Setting Priority.

■ MY16-CII

Right-click the block and select [Open MY-Card Editor] from the context menu to display the editor for it.

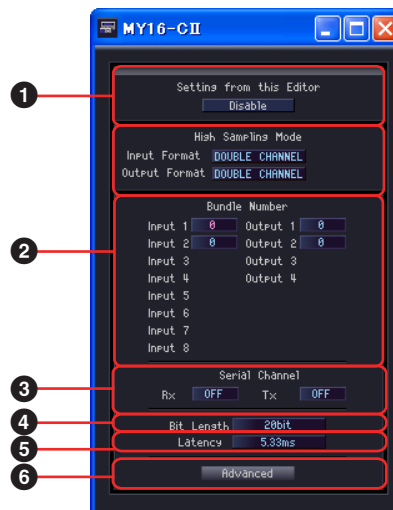

	Section	Name/Parameter	Range	Function
1	Setting from this Editor		Disable/Enable	When “Disable” is selected settings made via the CobraNet network take priority. When “Enable” is selected settings made from the DME Designer take priority.*
2	High Sampling Mode	Input Format	DOUBLE CHANNEL/ SINGLE	Selects the format for 88.2/96 kHz sampling rates. Linked to Output Format.
		Double FS	ON/OFF	When turned ON the speed of the MY card word clock output is doubled. Only available when the card is set as the word clock master.
		Output Format	DOUBLE CHANNEL/ SINGLE	Selects the format for 88.2/96 kHz sampling rates. Linked to Input Format.
3	Bundle Number	Input	0 ~ 65279	Specifies the input bundle number.
		Output	0 ~ 65279	Specifies the output bundle number.
4	Serial Channel	Rx	OFF, 1 ~ 15	Specifies the serial receive channel.
		Tx	OFF, 1 ~ 5	Specifies the serial transmit channel.
5	Properties	Bit Length	Bit Off 16bit 20bit 24bit	Specifies the output bit rate. Output is muted when “Bit Off” is selected.
6		Latency	5.33ms 2.67ms 1.33ms	Specifies the latency.
7		Advanced	-	Opens the “Advanced Settings” Window. Refer to “Advanced Settings” Window on page 496 for details.

* Select “Disable” if you intend to make settings via the CobraNet network using the CobraNet Manager, for example. In such cases selecting “Enable” may result in incorrect settings.

NOTE

Refer to the “MY16-CII Owner’s Manual” or “CobraNet Manager Lite for YAMAHA Owner’s Manual” for more information on CobraNet.

MY4-AEC

This editor will appear when you click [Open MY-Card Editor] in the contextual menu that appears when you right-click the block.

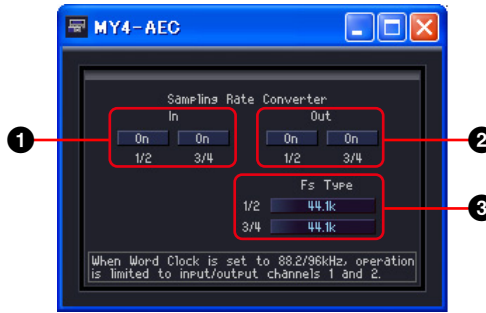

	Section	Name	Range	Function
1	Sampling Rate Converter	On(In)	ON/OFF	Turns the sample rate converter for input channels 1/2 or 3/4 ON or OFF.
2		On(Out)	ON/OFF	Turns the sample rate converter for output channels 1/2 or 3/4 ON or OFF.
3		Fs Type	44.1k 48k 88.2k 96k AES/EBU_IN_CH1/2 AES/EBU_IN_CH3/4	Sets the sampling rate for output channels 1/2 or 3/4. This parameter is only available when (2) On(Out) is ON. When set to [AES/EBU_IN_CH1/2] or [AES/EBU_IN_CH3/4], the output audio signal is synchronized to the clock of the signal received at the MY4-AEC card's AES/EBU [IN 1/2] or [IN 3/4] input connector, respectively.

Remote Controlled Head Amp

There are AD824 and AD8HR components arranged in the zone window.

■ AD824

Controls the Yamaha A/D converter AD824. The AD824 is an eight channel analog to digital converter.

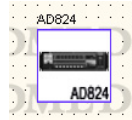

Double-click the component to display the component editor for it.

NOTE

If a DME is not selected in the properties dialog box, the component editor will not be displayed even if you double-click (page 230).

AD824 component editor



	Parameter	Setting Range	Function
1	+48V	ON/OFF	Turns ON phantom power (+48V).
2	Gain	+10 to -62 dBu	Sets the head amp gain.
3	Word Clock	48 kHz 44.1 kHz BNC Slot	Sets the operating frequency for the Word Clock.

■ **AD8HR**

Controls the Yamaha A/D converter AD8HR. The AD8HR is an eight channel analog to digital converter.

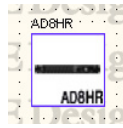

Double-click this component to display the component editor for it.

NOTE

If a DME is not selected in the properties dialog box, the component editor will not be displayed even if you double-click (page 230).

AD8HR component editor



	Parameter	Setting Range	Function
1	+48V	ON/OFF	Turns ON phantom power (+48V).
2	HPF	ON/OFF	Turns output ON.
3	Frequency	20 to 600Hz	Sets the cutoff frequency.
4	Gain	+10 to -62 dBu	Sets the head amp gain.
5	Word Clock	96 kHz 88.2 kHz 48 kHz 44.1 kHz Word Clock In Digital Out A	Sets the operating frequency for the Word Clock.
		Double Speed Double Channel	Selects the operation for 88.2/96 kHz.
6	+48V Master		Shows the on/off status of the master phantom power.

Component Glossary

Adjustable Gc (AdjustGc)

One type of filter characteristic. With this setting, you can adjust Gc (gain on the cutoff frequency) between -6 dB and +6 dB. If you set -3 dB it becomes a Butterworth filter. If you set -6 dB, it becomes Linkwitz-Riley filter.

Attack (Attack Time)

In dynamic components, sets the time period for compressing or expanding the signal after the component operates. As the attack time is made faster, compression or expansion becomes more instantaneous. As it is made slower, the initial attack part of the sound will not be compressed or expanded.

Bessel

One type of filter characteristic. For curves where phase characteristics are important, Bessel has gentler attenuation than Butterworth, and there is little distortion of the waveform when square waves are passed through.

Butterworth (Buttrwrth)

One type of filter characteristics. This filter has the most general characteristics. The pass band is flat and the gain for the cutoff frequency is -3 dB.

Bypass

Passes the signal without changing it. When you turn this ON, bypassed sound (unchanged sound) is output. When you turn this OFF, the sound is output with effects applied.

Decay (Decay Time)

Sets the time period until gain returns to normal after a trigger signal level falls below the threshold value.

Delay

Sets the time period by which a signal is delayed.

Delay Scale

Sets the units used for specifying the delay time.

Divergence

Sets the ratio for sending the center signal to LR. When 100 percent is set, the signal will be sent to LR only. When zero percent is set, the signal is sent to center only.

Fade

Sets the action of the fader when there is a large change in its position during scene recall. When you turn this ON, the fader moves gradually to the position after the jump. If you turn this OFF, it immediately jumps to the parameters saved in the recalled scene.

Frequency

Sets a frequency. In the de-esser, this sets the lowest frequency of the signal to be compressed when the component is operating. In the BPF, HPF, and LPF filters, this sets the cutoff frequency. In the graphic equalizer, it is also used as the frequency band button.

Gain

Sets the amplification factor for the entire signal level.

Gain Correct

In the Auto-Mixer, automatically controls the output level for the number of open channels. In situations, where multiple microphones are used, feedback may occur because many channels are open at the same time. Feedback can be avoided by using gain correct.

Hold (Hold Time)

Sets how long the gate stays open or the ducking remains active once the trigger signal has fallen below the threshold level.

KeyIn

Turns an input signal connected to a component's KeyIn port into a trigger that activates the component. You can select the trigger source in components that have KeyIn ports.

Knee

In compressors, de-essers, and expanders, sets the way in which compression or expansion will be applied after the signal exceeds the threshold. The following range of settings is available: HARD, 1, 2, 3, 4, 5.

If Hard is set, the signal level changes to a straight line following the specified slope when the trigger signal exceeds the threshold.

If a value between 1 and 5 (5 = softest) is specified, the curve gradually changes when the threshold is exceeded, producing a more natural sound.

LFE (Sub Woofer Speaker)

This is a special speaker for playing back low frequency sounds.

Linkwitz-Riley (Linkwitz)

One type of filter characteristics. As second-order filters, the sum of the output voltages for LPF and HPF have a gain of 0dB across the entire band. The pass band is flat, but the cutoff frequency gain is -6 dB.

Pan

Sets the distribution ratio of the input signal between right and left.

Pan Nominal Position

Sets the 0 dB reference for pan. There are two selections available, [Center] and [LR] (LR Nominal). With the "Center Nominal" setting, level is nominal when pan is set to center, and level is +3dB when pan is set fully left or right.

With the "LR nominal" setting, level is -3dB when pan is set to center, and nominal when pan is set fully left or right.

Phase

Reverses the phase of the signal. If you turn this ON, signal is inverted. If you turn this OFF, the signal is not inverted.

Q

Sets the frequency bandwidth that will change the sound. As the value gets larger, the width gets narrower and the curve becomes steeper.

In the parametric equalizer, this sets the frequency width where the gain will be cut or boosted. When Q is widened, the gain is boosted or cut along a wide range centering on the frequency set by the frequency setting, resulting in a large change in the tone quality. When Q is narrowed, only a specific frequency is boosted or cut.

Range

Set for Ducking and Gate. Sets the amount by which the level is reduced when signal is ducked/gated. It can be set within the range of -70 to 0 dB. At -70 dB the entire signal above the threshold value is cut. At 0 dB, there is no effect.

Ratio

Sets the ratio of change in the output signal level with respect to the input signal level.

At 1:1, there is no compression.

At 2:1, when a trigger signal level that exceeds the threshold changes by 10 dB, the output level will change by 5 dB.

Release (Release Time)

Sets the time period until gain returns to normal after a trigger signal level falls below the threshold value and operation of a component ceases.

If the release time is short, the sound will seem like it is jumping (the ear will notice the change) because the gain suddenly returns to normal. If the release is set too long, compression might not be applied properly because the next high level signal will be input before the gain returns to normal from the previous high. It's a good idea to try an initial release time setting in the range of 0.11 to 0.5 milliseconds.

Slope

In a high pass filter (HPF) or low pass filter (LPF), this sets the attenuation amount for each octave. A large value results in rapid attenuation. Clicking the [Slope] button displays a menu.

You can select [6 dB/Oct] or [12 dB/Oct] in the HPF or LPF.

In the crossover that is part of the crossover processor, in the stand-alone crossover, the programmable BPF, the programmable LPF, and the programmable HPF, you can select from [6 dB/Oct], [12 dB/Oct], [18 dB/Oct], [24 dB/Oct], [36 dB/Oct], and [48 dB/Oct].

Threshold

Sets the signal level that causes the component to operate.

Width

Sets how much lower the level must be than the threshold level for the expansion effect to begin. When the trigger signal level changes by 2 dB with the expansion ratio of the expander set at 5:1, the output level will change by 10 dB.

In the compander, if the width is set at 90 dB, the expander effect will be essentially be turned OFF.

Appendix

Options

The ICP1, CP4SW, CP1SF, and CP4SF controllers are optionally available for remote external control of the DME. The ICP1 connects via Ethernet, while the CP4SW, CP1SF, and CP4SF connect via the GPI interface.

ICP1 settings and operation

This controller connects to the DME series via Ethernet. Like the DME series, each ICP1 unit has its own IP address. With a display that replicates the display on the DME series, the ICP1 allows comprehensive, familiar control from remote locations.

ICP1 Controls

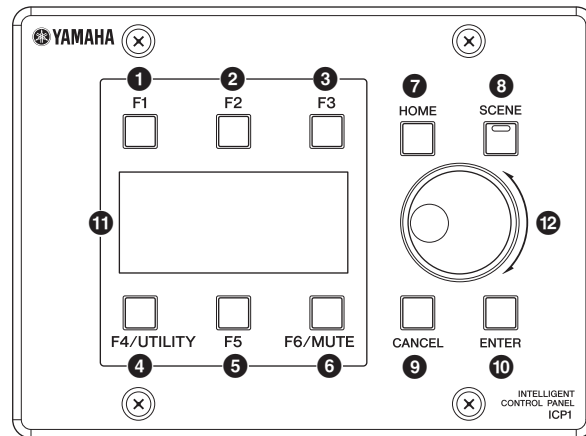

1 [F1] Key

When the Main display is showing this button calls the Parameter Edit display for the User Defined Button in the upper left corner of the display.

When the Utility display is showing it has the same function as the Left button.

2 [F2] Key

When the Main display is showing this button calls the Parameter Edit display for the middle User Defined Button in the upper part of the display.

When the Utility display is showing it has the same function as the Up button.

3 [F3] Key

When the Main display is showing this button calls the Parameter Edit display for the User Defined Button in the upper right corner of the display.

When the Utility display is showing it has the same function as the right button.

4 [F4/UTILITY] Key

When the Main display is showing this button calls the Parameter Edit display for the User Defined Button in the lower left corner of the display. If this button is pressed and held for longer than 2 seconds when the Main display is showing the Utility display will appear. Pressing the [F4] button while the Utility display is showing sequentially steps through the various Utility pages.

5 [F5] Key

When the Main display is showing this button calls the Parameter Edit display for the middle User Defined Button in the lower part of the display.

When the Utility display is showing it has the same function as the Down button.

6 [F6/MUTE] Key

When the Main display is showing this button calls the Parameter Edit display for the User Defined Button in the lower right corner of the display.

If this button is pressed and held for more than 2 seconds the Mute display will appear.

7 [HOME] Key

Directly recalls the home (main) display. If pressed while the main display is showing the [HOME] button steps through the User Defined Button display pages ([page 514](#)).

8 [SCENE] Key

Calls the scene recall display ([page 515](#)). Calls the scene store confirmation display if pressed and held for longer than 2 seconds ([page 515](#)). The indicator will light green while the scene recall/store display is showing.

9 [CANCEL] Key

Closes the window on the display.

10 [ENTER] Key

Confirms and enters a value or setting.

11 Display

Displays scene information and device parameters.

12 Dial

Adjusts the value of selected parameters. The ICP1 dial functions in the same way as the DME64N/24N dial.

Main Display

The Main display will appear in a few seconds after the power is turned on. The Main display shows information about the current scene.

NOTE

Nothing will appear on the display if no scene data is stored in the DME series scene memory (this is the case when the unit is initially shipped, for example).

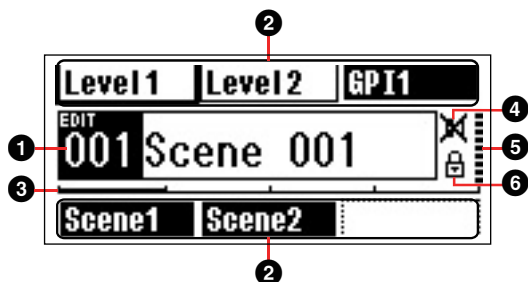

1 Scene Information

The current scene number and name. Scene names can be entered by using the DME Designer application.

A maximum of 12 one-byte (Roman) characters can be displayed in a scene name. When “two-byte” characters are to be used for languages such as Japanese, the total number of displayable characters is reduced accordingly.

When the power is turned on the last scene selected before the power was turned off is automatically recalled.

2 User Defined Button Names

Displays the User Defined Button. The User Defined Button is specified by using the DME Designer application.

A maximum of 24 buttons can be made available for user control, but only six buttons can be shown in any one display page. Press the [HOME] key to switch to other available button pages. A maximum of 8 one-byte (Roman) characters can be displayed in a parameter name. When “two-byte” characters are to be used for languages such as Japanese, the total number of displayable characters is reduced accordingly.

Parameters are selected for editing by using [F1]/[F2]/[F3]/[F5] keys to select the parameter, and then pressing [ENTER].

3 Page Scroll Bar

The scroll bar provides an indication of which parameter page is currently being displayed. 4 pages are available, and the scroll bar moves one position to the right each time the [HOME] key is pressed and a new page of parameters is selected, and then back to the leftmost position after the rightmost position has been reached.

4 Edit Indicator

If a parameter is changed after recalling a scene, “EDIT” will appear in the display.

5 Mute Indicator

Shows the current mute ON/OFF status.

: Mute ON

: Mute OFF

6 Output Level Indicator

Displays the current output level in 10 increments. The longer the “bar,” the higher the output level.

7 Panel Lock Icon

This icon appears when the panel lock function is turned ON.

: Panel Lock ON (Panel controls locked)

Panel Lock

The panel controls can be “locked” to prevent accidental mis-operation.

To activate the panel lock function simultaneously press and hold the [HOME] and [ENTER] keys for longer than 2 seconds.

The panel lock icon will appear on the Main display when the panel is locked.

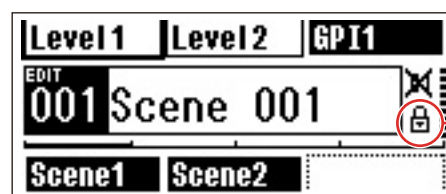

Panel lock icon

Panel Lock can be disengaged by pressing the [CANCEL] key for longer than 2 seconds.

NOTE

You can select whether or not the panel lock function is automatically engaged when the unit is initially turned on. This selection can be made via the Utility display “Lock” page (refer to the [page 518](#)).

Parameter Edit Displays

Parameter Edit displays will appear when the [SCENE], [F6/MUTE] or other key is pressed to allow scene changes, level adjustment, and other settings to be edited as required. Parameter Edit displays are also used to edit utility parameters.

In most cases the desired parameter edit page can be accessed by selecting the item you want to edit in the appropriate display by using the [F1]/[F2]/[F3]/[F5] keys and then pressing the [ENTER] button.

There are basically three types of parameters that can be accessed via a Parameter Edit display:

- Numeric values
- Lists
- ON/OFF switches

Numeric Parameters

Numeric parameters can be edited in a number of ways, and depending on the parameter a fader, knob, or minimum and maximum values may appear to the left of the numeric value.

A Numeric Value with a fader

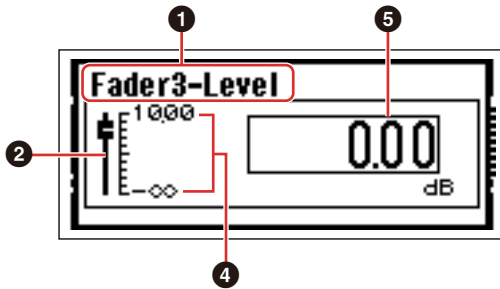

A Numeric Value with a Knob

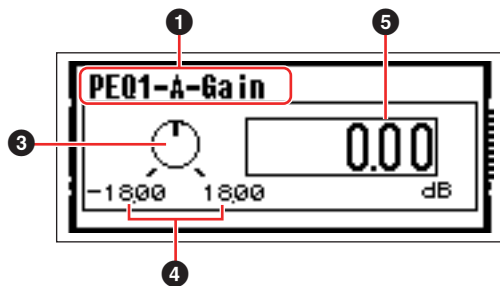

- 1 Name of parameter selected for editing
- 2 Fader
- 3 Knob
- 4 Minimum and maximum values
- 5 Current value

Some Parameter Edit displays have just one numeric parameter, while other may have two or more.

Parameter Edit Display with One Numeric Parameter

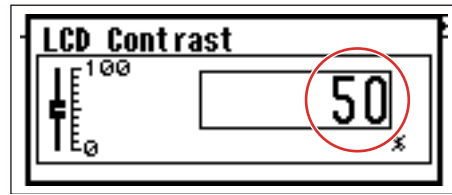

1. Numeric values can be changed by rotating the dial. Dial rotation produces an immediate, corresponding change in the selected value.

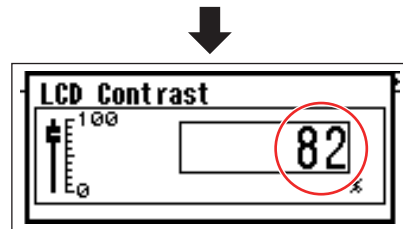
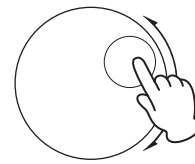

2. Press the [ENTER] key to close the Parameter Edit display after the value(s) have been edited as required.

Parameter Edit Display with Multiple Numeric Parameters

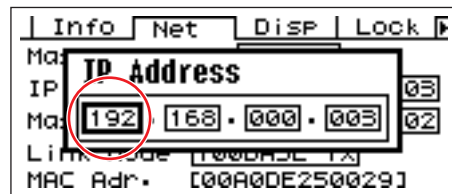

1. Use the [F1]/[F2]/[F3]/[F5] keys to select the value to be edited.

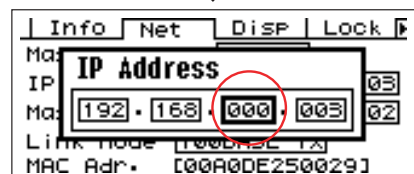
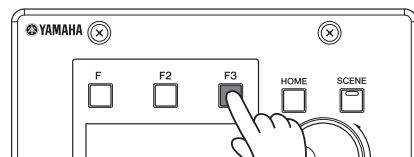

2. Rotate the dial to edit the value as required.

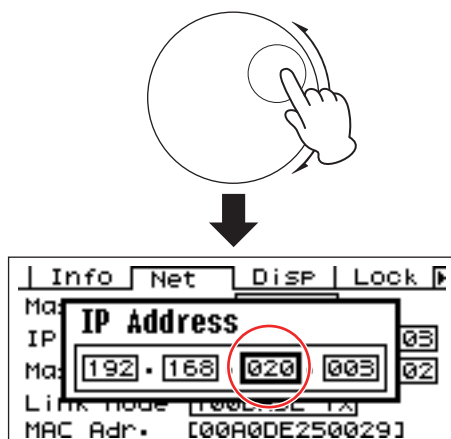

3. Repeat step 1 to select the next value to be edited, use the dial to edit as required, and repeat until all values have been edited as required.

4. When all values have been edited, press the [ENTER] key. A confirmation window will appear: press [ENTER] one more time to confirm the edits and close the window.

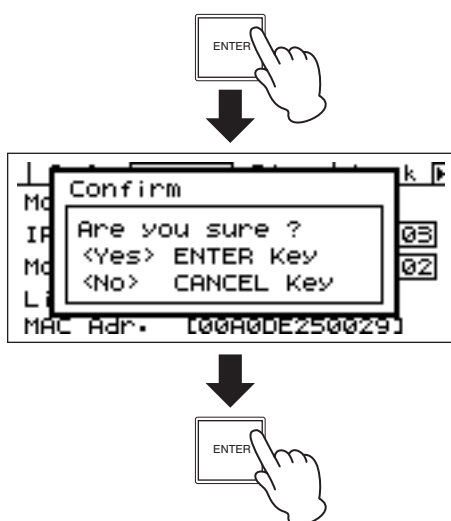

NOTE

You can return to the Parameter Edit display without changing any values by pressing the [CANCEL] key rather than the [ENTER] key.

List Parameters

List parameters allow you to make one selection from a list of possibilities.

Rotate the dial to scroll up or down the list. In some cases the centermost item on the display will be always highlighted as the list is scrolled, and in others the same item will remain highlight as the list is scrolled up or down.

List Parameter with Scrolling Highlight

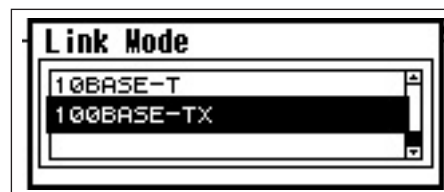

1. Use the dial to scroll up or down the list.

As you scroll the highlighted selection will remain highlighted, and will scroll up or down with the list.

2. Press the [ENTER] key to highlight the centermost item on the display.

NOTE

In some cases a confirmation dialog will appear when the [ENTER] key is pressed. If this occurs press the [ENTER] key a second time to continue.

3. Press the [ENTER] key to select the highlighted item and close the window.

ON/OFF Parameters

Parameters that are either ON or OFF are edited via this type of display (e.g., Mute Parameter Edit display in “Mute Switching”).

1. Rotate the dial clockwise to select ON, or counterclockwise to select OFF.
2. Press enter to confirm the selection and close the window.

Parameter Edit displays will also appear when the [SCENE], [F6/MUTE] or other key is pressed. These allow scene changes and other settings to be edited as required.

Editing User Defined Button

1. If the Main display is not showing, press the [HOME] key to recall it.
2. Press the [HOME] key until the page containing the parameter to be edited appears.
3. Use the [F1]/[F2]/[F3]/[F5] keys select the parameter to be edited.

The Parameter Edit display for the selected User Defined Button will appear.

NOTE

User Defined Button can be of all three types: numeric, list, and ON/OFF.

4. User Defined Button as required.

Refer to “Parameter Edit Displays” on [page 512](#) for editing procedures.

NOTE

Any changed User Defined Button values will be lost if the power is turned off or if scenes are changed. To preserve the changed values, store the scene data.

Mute Switching

Turns the DME series output mute function ON or OFF.

1. Press the [F6/MUTE] key for longer than 2 seconds.

The Mute Parameter Edit display will appear.

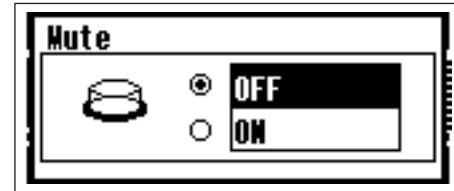

2. Select Mute ON or OFF.

The mute function is turned on or off as described in “ON/OFF Parameters”.

NOTE

All outputs in the device group, including the [PHONES] jack, are muted.

Scene Recall

This procedure recalls a new scene (refer to [page 512](#)).

1. Press the [SCENE] button.

The Scene Recall display will appear.

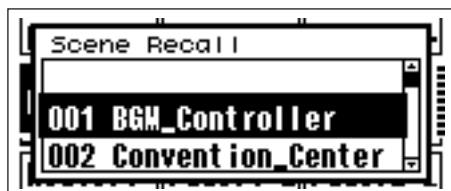

2. Select a new scene.

Scenes are selected as described in the "List Parameters" section on [page 513](#).

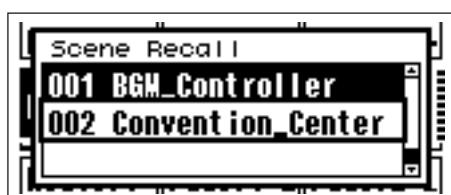

3. Press the [ENTER] button.

A confirmation message will appear.



4. Press the [ENTER] button again.

The new scene will be selected.

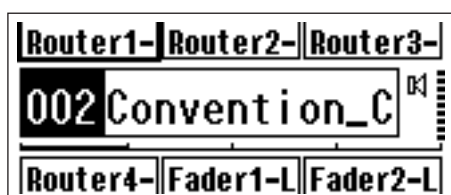

NOTE

If head amplifier parameters are included in the recalled scene data, the head amplifier settings will be changed accordingly.

Scene Store

Stores the current scene data for later recall.

1. Press the [SCENE] button for longer than 2 seconds.

A confirmation window will appear on the display.



2. Press the [ENTER] key.

This stores the scene data in the current scene memory.

NOTE

Press the [CANCEL] key if you want to abort the scene store operation.

Utility Displays

Most basic ICP1 functions can be accessed via the Utility Display.

Items accessible via the Utility display

Page	Item	Description	Manual Page
Info		Current status and settings for the devices basic parameters.	page 517
	Label	Name display.	
	Version	The device's current version number.	
Net		Current status and settings for the Ethernet network.	page 517
	Master/Slave	Displays current status whether the device is device group master or not.	
	IP Adr.	Current status and setup for the device's IP address.	
	Master ID	Displays and sets the device group master host address.	
	Link Mode	Current status and setup for the [NETWORK] connector.	
	MAC Adr.	Displays the device's MAC address.	
Disp		Current status and setup for the display mode, etc.	page 518
	LCD Contrast	Current status and setup for display panel contrast.	
	LCD Backlight	Current status and setup for the display panel backlight.	
Lock		Current status and setup for panel lock and related functions.	page 518
	Utility	Current status and setup for the Utility display settings.	
	Panel Lock Boot	Current status and setup for the ICP1's power-on panel lock status.	
	Panel Lock Target	Current status and setup for the panel lock target.	
	User Defined Lock	Panel lock and setup for each page of user-defined parameters.	
Misc		Current status and setup for settings not included in other pages.	page 519
	Scene Store	Current status and setup for scene store accessibility.	
	Last Mem. Resume	Indicates whether the previous memory contents will be retained when the unit is restarted.	
	Event Scheduler	Current status whether an event schedule setup in the DME Designer will be executed or not.	

Utility Display Operation

The general procedure for operating the Utility displays is outlined below.

1. Press the [F4/UTILITY] Key for longer than 2 seconds from the Main display to go to the Utility display.
2. Press the [F4/UTILITY] Key as many times as necessary until the desired parameter page appears.
3. Use the [F1]/[F2]/[F3]/[F5] keys to select the parameter you want to edit.
4. Press the [ENTER] key.
This either confirms a selection or edit, or calls the appropriate parameter edit page.

Info Page

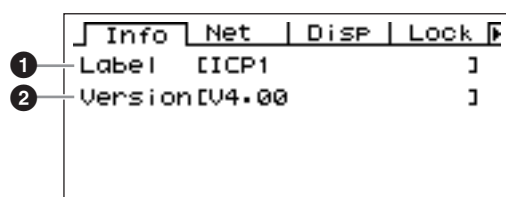

NOTE

The date and time (3) and the internal battery status (4) are not shown on the ICP1 control panel display.

1 Label

Shows the user ID. The user ID can be changed via the DME Designer application running on a computer connected to the unit.

NOTE

The label can not be changed from the ICP1 controls.

2 Program Version

This is the current firmware version number.

Network Settings (Net) Page

Shows the Ethernet network address and other parameters.

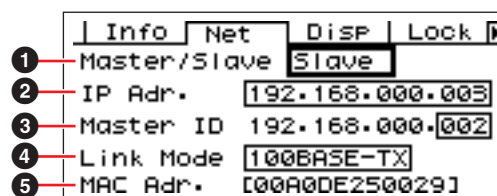

1 Master/Slave

Indicates whether or not the device is functioning as the device group master.

Device Group status of ICP1 is fix to "Slave."

2 IP Adr.

This is the device's IP address.

Edit using the "Numeric Parameters" editing procedure described on [page 512](#).

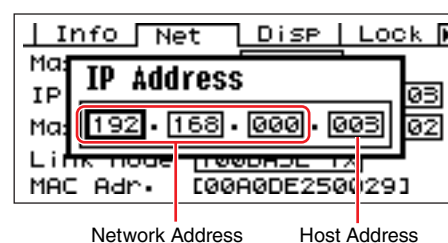

NOTE

The network addresses of devices in the same device group must be the same.

3 Master ID

Displays and sets the device group master host address.

4 Link Mode

Shows the status of the [NETWORK] connector. The [NETWORK] connector can be set to operate in "10Base-T" or "100Base-TX" mode.

10Base-T: The [NETWORK] connector is compatible with 10Base-T operation.

100Base-TX: The [NETWORK] connector is compatible with 100Base-TX operation.

Edit using the "List Parameters" editing procedure described on [page 513](#).

5 MAC Adr.

This is the device's MAC (Media Access Control) address.

NOTE

The MAC address is also known as the Ethernet address, and is an independent address assigned to all Ethernet devices. No two devices anywhere in the world can have the same address.

Display Setup (Disp) Page

Provides access to a number of display parameters.

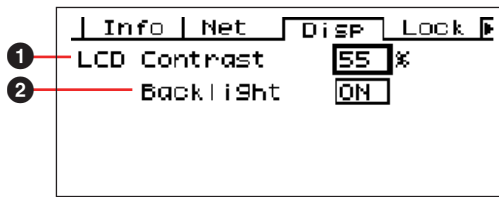

1 LCD Contrast

The current LCD contrast setting. This parameter can be adjusted from 0% through 100%. Edit using the “Numeric Parameters” editing procedure described on [page 512](#).

2 LCD Backlight

Specifies LCD backlight operation. Two settings are available: “ON,” and “OFF.”

ON: The display is continuously lit.

OFF: The display lights when a control is operated, and will go out 10 seconds after panel operation ceases.

Pressing the [ENTER] key alternately selects “ON” and “OFF”.

Security Setup (Lock) Page

Panel lock and related settings.

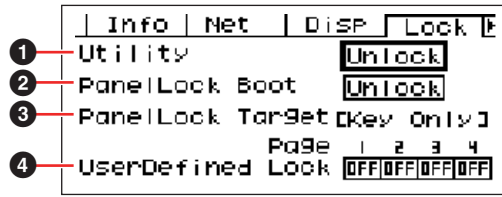

1 Utility

The lock status for the Utility display settings. This parameter can be set to “Unlock” or “Lock.”

Unlock: The Utility display can be accessed without a password.

Lock: A password must be entered to access the Utility display.

When “Lock” is selected a password entry window will appear when the [F4/UTILITY] key is pressed to access the utility pages.



Use the [F1] and [F3] buttons to position the cursor, and the dial to enter the desired character at the cursor location. When all of the password’s characters have been entered as required press the [ENTER] key.

The password will also be required when switching from the “Unlock” mode to the “Lock” mode.

NOTE

Password security and management is very important!
 If you forget your password the unit cannot be operated!
 If you forget your password contact the system administrator.
 If the password become unrecoverable for some reason and you need to unlock the system, please contact your Yamaha representative.

2 Panel Lock Boot

Determines whether or not panel lock will be on when power to the device is turned on. This parameter can be set to “Unlock” or “Lock.”

Unlock: Panel lock is OFF when power to the device is turned on.

Lock: Panel lock is ON when power to the device is turned on.

3 Panel Lock Target

Displays the controls (control functions) to be affected by panel lock. Panel Lock Target status of ICP1 is fix to “Key Only.”

NOTE

See [page 511](#) for details on how to use the Panel lock feature.

4 User Defined Lock

Sets the lock status individually for each of the four User Defined Button pages.

ON: The corresponding User Defined Button will not appear on the display.

OFF: The corresponding User Defined Button will appear on the display.

To change the settings use the [F1] and [F3] keys to move the cursor to the setting for the desired page, the press the [ENTER] button to alternately turn the setting “ON” and “OFF.”

NOTE

The User Defined Button are accessed as described in the “Parameter Edit Display” section on [page 512](#).

Miscellaneous Setup (Misc) Page

This page includes parameters not available in any other page.



1 Scene Store

Determines whether or not scene store operations are allowed. This parameter can be set to “Enable” or “Disable.”

Enable: Scene store operations are allowed.

Disable: Scene store operations are prohibited.

Edit using the “List Parameters” editing procedure described on [page 513](#).

NOTE

See [page 515](#) for scene store procedure.

NOTE

This setting applies to individual devices only. Even if one ICP1 unit is set to “Disable,” scene store operations will be possible via another DME series in the same device group that is set to “Enable.”

2 Last Mem. Resume

This parameter displays whether the ICP1 will recall the current scene when started up, or whether the memory contents at the time the unit was turned off will be recalled.

ON: The memory contents at the time the unit was turned off will be recalled at startup.

OFF: The current scene will be recalled at startup.

The Last Mem. Resume status can not be changed from ICP1 controls.

3 Event Scheduler

Displays the current status of an event schedule setup in the DME Designer will be executed or not.

ON: The event will be executed.

OFF: The event schedule will not be executed.

Edit using the “List Parameters” editing procedure described on [page 513](#).

NOTE

The event schedule status can not be changed from the ICP1 controls.

Initializing the ICP1

Follow the steps below to initialize the internal memory.



When the internal memory is initialized, all data stored in the memory will be lost. Use caution when you execute this function.

- 1. Turn off the power to the ICP1.**
- 2. Plug the PA-300 AC adaptor while holding down the [SCENE] and [ENTER] buttons. Release keys after YAHAMA logo disappears.**
The Initialization display appears.
- 3. Press the [F2]/[F5] keys to select a type of initialization.**

NOTE

To cancel the initialization operation, select "==> Exit Diag Mode" and confirm the cancellation. Alternatively, simply turn off the power to the ICP1.

Initialize DME:

Deletes all user settings except component data. The Utility settings will be set to default values.

Delete All Data:

Component data will be deleted. The Utility settings will be set to default. After initialization, transfer necessary components from DME Designer.

==> Exit Diag Mode:

Leaves this screen and restarts.

- 4. Press the [ENTER] key.**

Do not turn off the power during initialization. Doing so can damage the device.

Troubleshooting

For the latest information about DME Designer, visit the Yamaha pro audio site at <http://www.yamahaproaudio.com>.

Symptom	Possible Causes	Corrective Actions
A compile error occurs during synchronization.	DSP total resource consumption has exceeded the upper limit.	Delete unneeded components.
	The wiring between components is connected from multiple output terminals to a single input.	Change the connections so that a single output is connected to a single input terminal. Using a matrix mixer or similar component, gather multiple outputs into one signal.
Cannot place component. Cannot place wiring.	You are in online status.	Execute [Go Off-line] on the synchronization screen to go into offline status.
	The Designer window is not in edit mode.	Place a checkmark next to [Edit] on the [Tool] menu.
	The currently logged on user is restricted from editing.	Logoff, then log in again as a new user, or as the Administrator. If edit restrictions are required for a user, place a check in the [Security] → [Edit] checkbox
A user module is not displayed on the list.	The [File] menu → [Preference] → [ContentsFolder] has been changed, or the "User Module" folder has been moved.	Check that there are user module files (.umf) in the "ContentsFolder" and "User Module" folders.
Cannot switch configurations in the Navigator Window.	While online, you cannot switch to a configuration different from the current scene.	If you can switch between scenes, you will be able to switch configurations.
The user module window does not open, even when a user module is double-clicked.	This is a user module saved by selecting [Open] → [User Module Design Window].	Open the save dialog, select [Open] → [User Module Editor], and resave the user module.
No editor displays after right-clicking on a card component, and selecting [Open] from the context menu.	Some cards do not have editors.	No special corrective action.
The message "Reset Config..." is displayed for a long time in the message area of the "Synchronization" dialog box.	This is not abnormal. If many scenes are entered into the DME, processing takes time.	Wait until processing finishes.
Cannot set the monitor output.	This is because channels connected with wiring cannot be used as monitor output.	Select an unconnected channel.
Poor meter response.	A large number of DME units displaying meters in the same device group.	<ul style="list-style-type: none"> • Close or minimize the component editor window to reduce the number of DME displays. • Divide the device group containing DME units displaying meters.
When the computer connection was changed the connection to the DME unit was lost.	If LAN cable connections are changed while DME Designer is running, the DME units will continue to attempt to connect to the original computer.	Either quit DME designer before changing the LAN connections, or set the Port parameter to No Assign.

Index

A	
AD824	230, 503
AD8HR	230, 504
"Add Event" dialog box	103
"Add User" dialog box	162
Adjustable Gc (AdjustGc)	505
[Administrator] User	157
AEC	482
Ambient Noise Compensator	379
Analog Input	492
Analog Output	493
Analyze	308
Area	3
[Area Parts List]	200
Area window	27, 297
Attack (Attack Time)	505
Audio Detector	381
Auto Gain Control	382
Auto Log On	31
Auto-Logon User	159
[Enable Auto-Log On]	159
Auto Mixer	431
Auto Mixer II	433
B	
Background Images	
setting	335
Backup	157
Band Pass Filter (BPF)	420
Bessel	505
Box (rectangle)	253
Butterworth (Butwrth)	505
Bypass	505
C	
[CANCEL] Button (ICP1)	510
"Cascade Setting" dialog box	221
"Change User Information" dialog box	162
Changing Order	278
Close	41
CobraNet Input	495
CobraNet Output	495
Communication Status	59
Companer	403
Component	29, 235
placing	302
Component Editor	30
Component Group	371
Component List	372
[Component List] (Configuration window)	201
[Component List] (User Module window)	202
Component Lock	150
Compressor	404
Configuration	192
adding	295
analysis	308
creating new	192
creation procedure	49
deleting	295
editing	192
renaming	295
Configuration window	28, 301
[Component List]	201
Control	
aligning	342
copy	343
cut	343
moving	342
paste	343
placing	337
properties	344
[Control Change] tab	126
Crossover	383
Crossover Processor	387
Crossover Processor II	393
Current Scene	57
Current Zone	56
D	
DAW Control	157
Decay (Decay Time)	505
De-Esser	405
Delay	399, 505
delay long	399
delay short	400
Delay Matrix	435
Delay Scale	505
Delay value	305
Design Mode	358
Design window	202
exporting	271
printing	274
shared settings and operations	268
Designer window	27
Device Group	3
Device Group Manager	293
Device Information	190
[Device List]	201
Disp Page	518
Display Order	278
Display Setup (Disp) Page	518
Divergence	505
DME	213
DME Data File	
export	44
import	42
Drawing Setting	282
Ducker	407
Dynamics	401
E	
"Edit Event" dialog box	103
[Edit] menu	63, 204
Edit Mode	192
Edit Palette	332
Ellipse	255
[Enable Auto-Log On]	159
[ENTER] Button (ICP1)	510
Equalizer	
Graphic Equalizer (GEQ)	414
Parametric Equalizer (PEQ)	416
Equalizer (EQ)	414
error message	511
Event Log List	80
"Event Log List" dialog box	79
Event Logger	177
"Event Scheduler" dialog box	101
Expander	408
Export	
Design window	271
DME	44
External Device	230

- F**
- [F1] Button (ICP1) 509
 - [F2] Button (ICP1) 509
 - [F3] Button (ICP1) 509
 - [F4/UTILITY] Button (ICP1) 509
 - [F5] Button (ICP1) 510
 - [F6/MUTE] Button (ICP1) 510
 - Fade 506
 - Fader 418
 - Feedback Suppressor 419
 - [File] menu 60
 - Filter
 - Band Pass Filter (BPF) 420
 - High Pass Filter (HPF) 421
 - Low Pass Filter (LPF) 422
 - Notch Filter (Notch) 423
 - Programmable BPF 424
 - Programmable HPF 426
 - Programmable LPF 427
 - Filters 419
 - Firmware Update
 - DME unit firmware 186
 - Frequency 506
- G**
- Gain 506
 - Gain Correct 506
 - Gate 409
 - General Purpose Interface (GPI) 112
 - "Get Log" dialog box 78
 - GPI (General Purpose Interface) 112
 - "GPI" dialog box 113
 - Graphic Equalizer (GEQ) 414
 - Grid 270
- H**
- [Help] menu 69
 - High Pass Filter (HPF) 421
 - Hold (Hold Time) 506
 - [HOME] Button (ICP1) 510
 - Hotspot 281
- I**
- ICP 224
 - placement 300
 - ICP1 509
 - Import
 - DME 42
 - Info Page 517
 - Internal HA Control 141
 - IP Adr. 517
- K**
- KeyIn 402, 506
 - Knee 506
 - Knob/Slider Conversion 343
- L**
- Language
 - setting 182
 - "Language" dialog box 182
 - LCD Backlight 518
 - LCD Contrast 518
 - LCR 453
 - Legend (Descriptive Fields) 260
 - LFE (Sub Woofer Speaker) 506
 - Library
 - recalling 366
 - storing 365
 - Link Mode 517
 - Linkwitz-Riley (Linkwitz) 507
 - List Parameter 513
 - Lock Page 518
 - Log Off 33
 - Log On 32
 - "Log Setup" dialog box 77
 - Logical connection 289
 - situations where no logical connection is created 289
 - Low Pass Filter (LPF) 422
 - LR 454
- M**
- MAC Adr. 517
 - Main display 511
 - Main Panel window 26, 54
 - Matrix Mixer 442
 - Menu bar 54, 193
 - Meter 428
 - MIDI 125
 - [Control Change] tab 126
 - [Parameter Change] tab 129
 - [Program Change] tab 128
 - "MIDI" dialog box 125
 - Misc Page 519
 - Miscellaneous 429
 - Miscellaneous Setup (Misc) Page 519
 - Mixer 431
 - Auto Mixer 431
 - Delay Matrix 435
 - Matrix Mixer 442
 - "Monitor" dialog box 179
 - Monitoring Point List 306
 - [Mute] button 58
 - Mute Indicator 511
 - Mute Switching 514
 - MY-Card 498
- N**
- Name 517
 - Navigator window 29, 197
 - Net Page 517
 - Network Settings (Net) Page 517
 - Notch Filter (Notch) 423
 - Numeric Parameter 512
- O**
- Object 29
 - arranging 275, 298, 299
 - editing 277
 - selecting 277
 - types 210
 - Offline 97
 - switching between online and offline 97
 - ON/OFF Parameter 514
 - Online 50, 97
 - switching between online and offline 97
 - Open 39
 - opening a project file from the "Recently Used Files" list 40
 - opening a project file that has security set 40
 - Operation Mode 358
 - Oscillator 429
 - Output Level Indicator 511
- P**
- Page Scroll Bar 511
 - Pan 453, 507
 - LCR 453
 - LR 454
 - Surround 455
 - Pan Nominal Position 453, 507
 - Panel Lock 511

- Panel Lock Boot 519
 - Panel Lock Icon 511
 - Panel Lock Target 519
 - [Parameter Change] tab 129
 - Parameter Link 94, 368
 - Parameter List 144
 - Parametric Equalizer (PEQ) 416
 - Partial Recall 85
 - Phase 507
 - Picture 247
 - placing 247
 - "Port" Dialog Box 155
 - Preferences 72, 268
 - Preset list 90
 - Print
 - Design window 274
 - [Print] menu 203
 - Probe Monitor 303
 - [Program Change] tab 128
 - Program Ducker 412
 - Programmable BPF 424
 - Programmable HPF 426
 - Programmable LPF 427
 - Project file 34
 - closing 41
 - creating new 34
 - opening 39
 - saving 35, 37
- Q**
- Q 507
- R**
- Range 507
 - Ratio 507
 - Recall Settings 86
 - Release (Release Time) 508
 - Remote Control Setup List 139
 - Remote Tab 172
 - Resource Meter 29
 - Resource Meter window 196
 - Room Combiner 460
 - Router 471
- S**
- Save 35, 37
 - saving a file with a new name 37
 - Save As 35, 37
 - Scene
 - current 57
 - [SCENE] Button (ICP1) 510
 - Scene Information 511
 - Scene Link Manager 151
 - Scene Manager 82
 - "Scene Manager" dialog box 82
 - Scene Recall 515
 - Scene Store (Misc Page) 519
 - Scene Store (Operation) 515
 - Security 192
 - [Administrator] User 157
 - creating users and making user settings 82
 - security for the Logged On User 91
 - user security level 158
 - user setting restrictions 157
 - Security Level 158
 - "Select Color" Dialog Box 265
 - "Select Font" dialog box 264
 - "Select Image" dialog box 267
 - Sheet 262
 - Show Signal Delay 305
 - Simple Mixer 450
 - Slope 508
 - Slot Component 240, 487
 - Snap 362
 - SP2060 Backup 184
 - SP2060 Input 494
 - SP2060 Output 494
 - Speaker Processor component 464
 - SPX Component 238, 471
 - Status bar 195
 - Surround 3-1 457
 - Surround 5.1 458
 - Surround 6.1 459
 - Synchronization
 - DME Designer and DME unit synchronization 97
 - "Synchronization" dialog box 98
- T**
- Tab Order
 - changing 357
 - Text box 251
 - Threshold 508
 - Title bar 54, 193
 - Tool button
 - large 56
 - small 54
 - Toolbar 194
 - Toolkit window 29, 198
 - displaying 199
 - moving 199
 - types 200
 - [Tools] menu 65, 207
- U**
- [User]
 - logged on user 58
 - User 31
 - creating new 163
 - list 160
 - User Control 91
 - creating new 326
 - security 328
 - "User Control Manager" dialog box 91
 - [User Control] menu 326
 - User Defined Button
 - User Defined Parameters 132
 - "User Defined Button" dialog box 132
 - User Defined Lock 519
 - User Defined Parameters 132
 - setting 135
 - User Module 243, 309
 - creating 309
 - saving 310
 - User Module Editor 330
 - User Module Manager 314
 - User Module window 28
 - [Component List] 202
 - User Setting Restrictions 157
 - User-defined parameter (Edit) 514
 - User-defined Parameter Names 511
 - Utility 167
 - Utility (Lock Page) 518
 - Utility display (Operation) 517
- V**
- Version 517
 - [View] menu 64, 205
- W**
- Wav File Manager 151
 - Wav File Player 430
 - Width 508

[Window] menu	69, 209
Window size	
changing	334
Wire	257, 279
drawing	282
drawing settings	282
editing	288
line segment	279
nodes	280
Word Clock	177

Z

Zone	211
adding	291
current	56
deleting	291
renaming	291
Zone (Net Page)	517
Zone window	28, 298

