



RX-V395

NATURAL SOUND AV RECEIVER

AMPLI-TUNER AUDIO-VIDEO

**OWNER'S MANUAL
MODE D'EMPLOI**

SAFETY INSTRUCTIONS

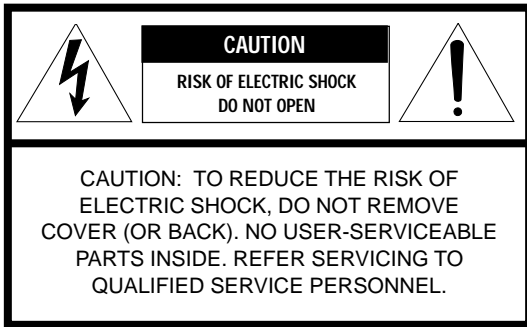

• Explanation of Graphical Symbols



The lightning flash with arrowhead symbol, within an equilateral triangle, is intended to alert you to the presence of uninsulated "dangerous voltage" within the product's enclosure that may be of sufficient magnitude to constitute a risk of electric shock to persons.



The exclamation point within an equilateral triangle is intended to alert you to the presence of important operating and maintenance (servicing) instructions in the literature accompanying the appliance.

WARNING
TO REDUCE THE RISK OF FIRE OR ELECTRIC SHOCK, DO NOT EXPOSE THIS UNIT TO RAIN OR MOISTURE.

1. Read Instructions – All the safety and operating instructions should be read before the unit is operated.
2. Retain Instructions – The safety and operating instructions should be retained for future reference.
3. Heed Warnings – All warnings on the unit and in the operating instructions should be adhered to.
4. Follow Instructions – All operating and other instructions should be followed.
5. Water and Moisture – The unit should not be used near water – for example, near a bathtub, washbowl, kitchen sink, laundry tub, in a wet basement, or near a swimming pool, etc.
6. Carts and Stands – The unit should be used only with a cart or stand that is recommended by the manufacturer.
 - 6A. A unit and cart combination should be moved with care. Quick stops, excessive force, and uneven surfaces may cause the unit and cart combination to overturn.
7. Wall or Ceiling Mounting – The unit should be mounted to a wall or ceiling only as recommended by the manufacturer.
8. Ventilation – The unit should be situated so that its location or position does not interfere with its proper ventilation. For example, the unit should not be situated on a bed, sofa, rug, or similar surface, that may block the ventilation openings; or placed in a built-in installation, such as a bookcase or cabinet that may impede the flow of air through the ventilation openings.
9. Heat – The unit should be situated away from heat sources such as radiators, stoves, or other appliances that produce heat.
10. Power Sources – The unit should be connected to a power supply only of the type described in the operating instructions or as marked on the unit.
11. Power-Cord Protection – Power-supply cords should be routed so that they are not likely to be walked on or pinched by items placed upon or against them, paying particular attention to cords at plugs, convenience receptacles, and the point where they exit from the unit.
12. Cleaning – The unit should be cleaned only as recommended by the manufacturer.
13. Nonuse Periods – The power cord of the unit should be unplugged from the outlet when left unused for a long period of time.
14. Object and Liquid Entry – Care should be taken so that objects do not fall into and liquids are not spilled into the inside of the unit.
15. Damage Requiring Service – The unit should be serviced by qualified service personnel when:
 - A. The power-supply cord or the plug has been damaged; or
 - B. Objects have fallen, or liquid has been spilled into the unit; or
 - C. The unit has been exposed to rain; or
 - D. The unit does not appear to operate normally or exhibits a marked change in performance; or
 - E. The unit has been dropped, or the cabinet damaged.
16. Servicing – The user should not attempt to service the unit beyond those means described in the operating instructions. All other servicing should be referred to qualified service personnel.
17. Power Lines – An outdoor antenna should be located away from power lines.
18. Grounding or Polarization – Precautions should be taken so that the grounding or polarization is not defeated.



19. For US customers only:

Outdoor Antenna Grounding – If an outside antenna is connected to this unit, be sure the antenna system is grounded so as to provide some protection against voltage surges and built-up static charges. Article 810 of the National Electrical Code, ANSI/NFPA 70, provides information with regard to proper grounding of the mast and supporting structure, grounding of the lead-in wire to an antenna discharge unit, size of grounding conductors, location of antenna discharge unit, connection to grounding electrodes, and requirements for the grounding electrode.

Note to CATV system installer:

This reminder is provided to call the CATV system installer's attention to Article 820-40 of the NEC that provides guidelines for proper grounding and, in particular, specifies that the cable ground shall be connected to the grounding system of the building, as close to the point of cable entry as practical.

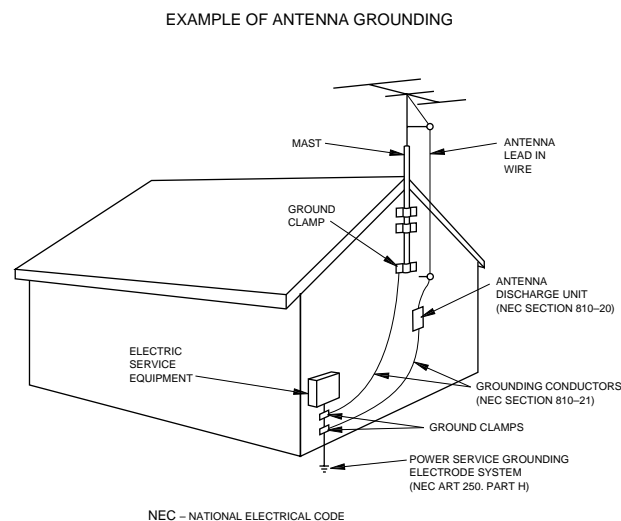

FCC INFORMATION (for US customers only)

1. IMPORTANT NOTICE : DO NOT MODIFY THIS UNIT!

This product, when installed as indicated in the instructions contained in this manual, meets FCC requirements. Modifications not expressly approved by Yamaha may void your authority, granted by the FCC, to use the product.

2. IMPORTANT : When connecting this product to accessories and/or another product use only high quality shielded cables. Cable/s supplied with this product MUST be used. Follow all installation instructions. Failure to follow instructions could void your FCC authorization to use this product in the USA.

3. NOTE : This product has been tested and found to comply with the requirements listed in FCC Regulations, Part 15 for Class "B" digital devices. Compliance with these requirements provides a reasonable level of assurance that your use of this product in a residential environment will not result in harmful interference with other electronic devices.

This equipment generates/uses radio frequencies and, if not installed and used according to the instructions found in the users manual, may cause interference harmful to the operation of other electronic devices.

Compliance with FCC regulations does not guarantee that interference will not occur in all installations. If this product is found to be the source of interference, which can be determined by turning the unit "OFF" and "ON", please try to eliminate the problem by using one of the following measures:

Relocate either this product or the device that is being affected by the interference.

Utilize power outlets that are on different branch (circuit breaker or fuse) circuits or install AC line filter/s.

In the case of radio or TV interference, relocate/reorient the antenna. If the antenna lead-in is 300 ohm ribbon lead, change the lead-in to coaxial type cable.

If these corrective measures do not produce satisfactory results, please contact the local retailer authorized to distribute this type of product. If you can not locate the appropriate retailer, please contact Yamaha Electronics Corp., U.S.A. 6660 Orangethorpe Ave, Buena Park, CA 90620.

The above statements apply ONLY to those products distributed by Yamaha Corporation of America or its subsidiaries.

We Want You Listening For A Lifetime

YAMAHA and the Electronic Industries Association's Consumer Electronics Group want you to get the most out of your equipment by playing it at a safe level. One that lets the sound come through loud and clear without annoying blaring or distortion – and, most importantly, without affecting your sensitive hearing.

Since hearing damage from loud sounds is often undetectable until it is too late, YAMAHA and the Electronic Industries Association's Consumer Electronics Group recommend you to avoid prolonged exposure from excessive volume levels.



SUPPLIED ACCESSORIES
ACCESSOIRES FOURNIS

- After unpacking, check that the following parts are included.
- Après le déballage, vérifier que les pièces suivantes sont incluses.

- Indoor FM Antenna
- Antenne FM intérieure

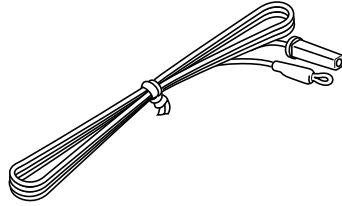

- AM Loop Antenna
- Cadre-antenne AM

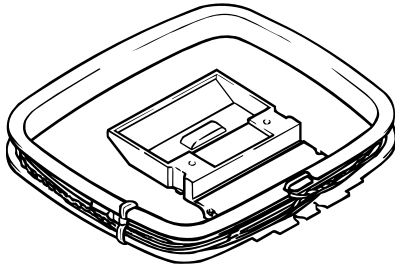

- Antenna adapter (U.S.A. and Canada models only)
- Adaptateur d'antenne (Modèles pour les États-Unis et le Canada seulement)

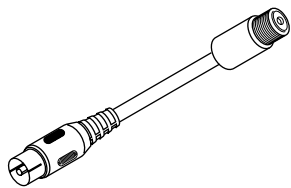

- Remote Control Transmitter
- Emetteur de télécommande

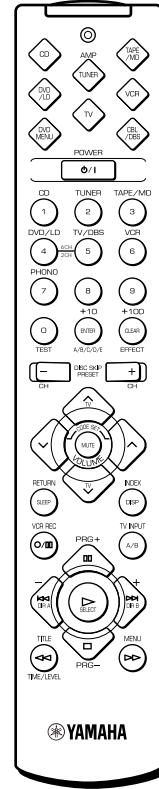

- Batteries (size AAA, R03, UM-4) (4)
- Piles (taille AAA, R03, UM-4) (4)

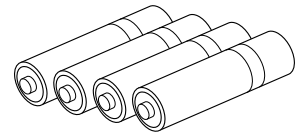

FEATURES

- **5 Speaker Configuration (Power Amp. Section)**
 - Main:** 60W + 60W (8Ω) RMS Output Power, 0.04% THD, 20–20,000 Hz
 - Center:** 60W (8Ω) RMS Output Power, 0.04% THD, 20–20,000 Hz
 - Rear:** 60W + 60W (8Ω) RMS Output Power, 0.04% THD, 20–20,000 Hz
- **Digital Sound Field Processor**
- **Dolby Pro Logic Surround Decoder**
- **Theater-like Sound Experience by the Combination of Dolby Pro Logic and YAMAHA DSP Technology (CINEMA DSP)**
- **Automatic Input Balance Control for Dolby Pro Logic Surround**
- **Test Tone Generator for Easier Speaker Balance Adjustment**
- **3 Center Channel Modes (NORMAL/WIDE/PHANTOM)**
- **40-Station Random Access Preset Tuning**
- **Automatic Preset Tuning**
- **Preset Station Shifting Capability (Preset Editing)**
- **IF Count Direct PLL Synthesizer Tuning System**
- **6-Channel External Decoder Input for Dolby Digital, DTS, and Other Future Formats**
- **Video Signal Input/Output Capability**
- **SLEEP Timer**
- **Universal Remote Control Transmitter with Preset Manufacturer Codes**

CONTENTS

SUPPLIED ACCESSORIES	2	TUNING OPERATIONS	26
FEATURES	3	PRESET TUNING	27
CAUTION	4	REMOTE CONTROL TRANSMITTER	30
NOTES ABOUT THE REMOTE CONTROL TRANSMITTER	5	USING DIGITAL SOUND FIELD PROCESSOR (DSP)	36
PROFILE OF THIS UNIT	6	SETTING THE SLEEP TIMER	40
SPEAKER SETUP	7	SETUP CODES	41
CONNECTIONS	8	TROUBLESHOOTING	42
CONTROLS AND THEIR FUNCTIONS	14	SPECIFICATIONS	43
SPEAKER BALANCE ADJUSTMENT	19	LIST OF MANUFACTURER'S CODES	87
BASIC OPERATIONS	22		

CAUTION : READ THIS BEFORE OPERATING YOUR UNIT.

1. To assure the finest performance, please read this manual carefully. Keep it in a safe place for future reference.
2. Install this unit in a cool, dry, clean place – away from windows, heat sources, sources of excessive vibration, dust, moisture and cold. Avoid sources of humming (transformers, motors). To prevent fire or electrical shock, do not expose the unit to rain or water.
3. Never open the cabinet. If something drops into the set, contact your dealer.
4. Do not use force on switches, controls or connection wires. When moving the unit, first disconnect the power plug and the wires connected to other equipment. Never pull the wires themselves.
5. The openings on the unit cover assure proper ventilation of the unit. If these openings are obstructed, the temperature inside the unit will rise rapidly. Therefore, avoid placing objects against these openings, and install the unit in a well-ventilated area to prevent fire and damage.

<China, U.K. and Europe models only>
Be sure to allow a space of at least 20 cm behind, 20 cm on the both sides and 30 cm above the top panel of the unit to prevent fire and damage.
6. Always set the VOLUME control to “– ∞” before starting the audio source play. Increase the volume gradually to an appropriate level after playback has been started.
7. Do not attempt to clean the unit with chemical solvents; this might damage the finish. Use a clean, dry cloth.
8. Be sure to read the “TROUBLESHOOTING” section regarding common operating errors before concluding that the unit is faulty.
9. When not planning to use this unit for long periods of time (i.e., vacation, etc.), disconnect the AC power plug from the wall outlet.
10. To prevent lightning damage, disconnect the AC power plug and antenna cable when there is an electrical storm.
11. Grounding or polarization – Precautions should be taken so that the grounding or polarization of an appliance is not defeated.
12. Do not connect audio equipment to the AC outlet on the rear panel if the equipment requires more power than the outlet is rated to provide.
13. **Voltage Selector <China and General models only>**
The voltage selector on the rear panel of this unit must be set for your local main voltage BEFORE plugging into the AC power supply.
Voltages are 110/120/220/240 V AC, 50/60 Hz.

IMPORTANT

Please record the serial number of this unit in the space below.

Model:

Serial No.:

The serial number is located on the rear of the unit. Retain this Owner's Manual in a safe place for future reference.

WARNING

TO REDUCE THE RISK OF FIRE OR ELECTRIC SHOCK, DO NOT EXPOSE THIS UNIT TO RAIN OR MOISTURE.

This unit is not disconnected from the AC power source as long as it is connected to the wall outlet, even if this unit itself is turned off. This state is called the standby mode. In this state, this unit is designed to consume a very small quantity of power.

FREQUENCY STEP switch <China and General models only>

Because the interstation frequency spacing differs in different areas, set the FREQUENCY STEP switch (located on the rear panel) according to the frequency spacing in your area.
Before setting this switch, disconnect the AC power plug of this unit from the AC outlet.

For Canadian Customers

To prevent electric shock, match wide blade of plug to wide slot and fully insert.

This Class B digital apparatus complies with CANADIAN ICES-003

For U.K. customers

If the socket outlets in the home are not suitable for the plug supplied with this appliance, it should be cut off and an appropriate 3 pin plug fitted. For details, refer to the instructions described on the right.

Note: The plug severed from the mains lead must be destroyed, as a plug with bared flexible cord is hazardous if engaged in a live socket outlet.

Special Instructions for U.K. Model**IMPORTANT**

THE WIRES IN MAINS LEAD ARE COLOURED IN ACCORDANCE WITH THE FOLLOWING CODE:

Blue: NEUTRAL

Brown: LIVE

As the colours of the wires in the mains lead of this apparatus may not correspond with the coloured markings identifying the terminals in your plug, proceed as follows: The wire which is coloured BLUE must be connected to the terminal which is marked with the letter N or coloured BLACK. The wire which is coloured BROWN must be connected to the terminal which is marked with the letter L or coloured RED. Making sure that neither core is connected to the earth terminal of the three pin plug.

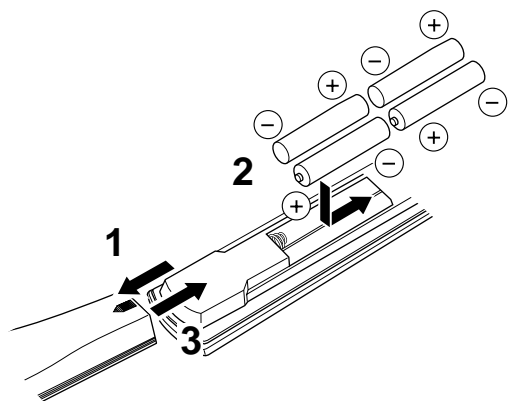
NOTES ABOUT THE REMOTE CONTROL TRANSMITTER**Battery installation****Battery replacement**

When you notice a decrease in the operating range of the remote control transmitter, the batteries are weak. Replace all batteries with new ones.

Notes

- Use only AAA, R03, UM-4 batteries for replacement.
- Be sure the polarities are correct. (See the illustration inside the battery compartment.)
- Remove the batteries if the remote control transmitter will not be used for an extended period of time.
- If batteries leak, dispose of them immediately. Avoid touching the leaked material or letting it come in contact with clothing, etc. Clean the battery compartment thoroughly before installing new batteries.
- When replacing batteries, try to install the new batteries within two minutes of removing the old batteries, or information stored in the remote control transmitter may be lost.

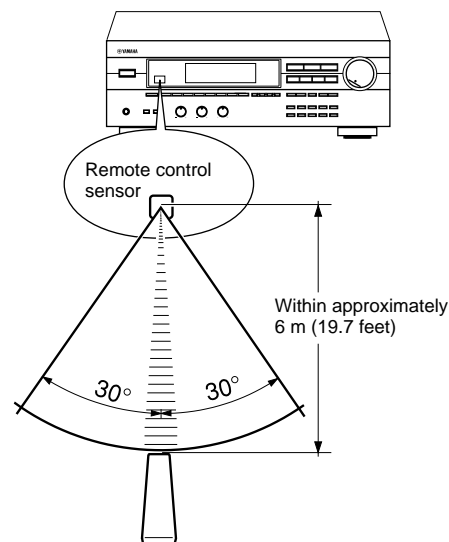
Remote control transmitter operation range**Notes**

- There should be no large obstacles between the remote control transmitter and the main unit.
- If the remote control sensor is directly illuminated by strong lighting (especially an inverter type of fluorescent lamp, etc.), it might cause the remote control transmitter not to work correctly. In this case, reposition the main unit to avoid direct lighting.

PROFILE OF THIS UNIT

You are the proud owner of a Yamaha stereo receiver – an extremely sophisticated audio component. The Digital Sound Field Processor (DSP) built into this unit takes advantage of Yamaha's undisputed leadership in the field of digital audio processing to bring you a whole new world of listening experiences. Follow the instructions in this manual carefully when setting up your system, and this unit will sonically transform your room into a wide range of listening environments – movie theater, concert hall, and so on. In addition, you get incredible realism from sources encoded with Dolby Surround using the built-in Dolby Pro Logic Surround decoder.

Please read this owner's manual carefully and store it in a safe place for later reference.

Digital Sound Field Processing

What is it that makes live music so good? Today's advanced sound reproduction technology lets you get extremely close to the sound of a live performance, but chances are you'll still notice something missing: the acoustic environment of the live concert hall. Extensive research into the exact nature of the sonic reflections that create the ambience of a large hall has made it possible for Yamaha engineers to bring you this same sound in your own listening room, so you'll feel all the sound of a live concert.

Furthermore, our technicians, armed with sophisticated measuring equipment, have even made it possible to capture the acoustics of a variety of venues such as an actual concert hall, theater, etc. to allow you to accurately recreate one of several actual live performance environments, all in your own home.

Dolby Pro Logic Surround

This unit employs a Dolby Pro Logic Surround decoder similar to professional Dolby Stereo decoders used in many movie theaters. By using the Dolby Pro Logic Surround decoder, you can experience the dramatic realism and impact of Dolby Surround movie theater sound in your own home. Dolby Pro Logic employs a four channel five speaker system. The Pro Logic Surround system divides the input signal into four levels: the left and right main channels, the center channel (used for dialog), and the rear surround sound channel (used for sound effects, background noise, and other ambient noises). The center channel allows listeners seated in even less-than-ideal positions to hear the dialog originating from the action on the screen while experiencing good stereo imaging. Dolby Surround is encoded on the sound track of pre-recorded video tapes, laser discs, and some TV/cable broadcasts. When you play a source encoded with Dolby Surround on this unit, the Dolby Pro Logic Surround decoder decodes the signal and distributes the surround-sound effects.

This Dolby Pro Logic Surround Decoder employs a digital signal processing system. This system improves the stability of sound at each channel and minimizes crosstalk between channels, so that positioning of sounds around the room is more accurate compared with conventional analog signal processing systems. In addition, this unit features a built-in automatic input balance control. This always assures you the best performance without manual adjustment.

Manufactured under license from Dolby Laboratories. "Dolby", "AC-3", "Pro Logic" and the double-D symbol are trademarks of Dolby Laboratories.

Dolby Pro Logic Surround + DSP

A Dolby Surround sound system shows its full ability in a large movie theater, because movie sounds are originally designed to be reproduced in a large movie theater using many speakers. It is difficult to create a sound environment similar to that of a movie theater in your listening room, because the room size, materials of inside walls, the number of speakers, etc. of your listening room is much different from those of a movie theater.

Yamaha DSP technology made it possible to present you with nearly the same sound experience as that of a large movie theater in your listening room by compensating for lack of presence and dynamics in your listening room with its original digital sound fields combined with Dolby Surround sound field.

The combination of Dolby Pro Logic Surround and DSP is used on the sound field program "PRO LOGIC ENHANCED".

CINEMA DSP

The YAMAHA "CINEMA DSP" logo indicates these programs are created by the combination of Dolby Pro Logic and YAMAHA DSP technology.

SPEAKER SETUP

SPEAKERS TO BE USED

This unit is designed to provide the best sound-field quality with a 5 speaker configuration. The most effective speakers to use with this unit are main speakers, rear speakers and a center speaker. You may omit the center speaker. (Refer to the “**4-Speaker Configuration**” shown below.)

The main speakers are used for the majority of the sound output as well as effect sounds. The rear speakers are used for the effect and surround sounds, and the center speaker is for the center sounds (dialog, etc.) within programs encoded with Dolby Surround. The center speaker needs to be equal in power to the main speakers, though the rear speakers should be slightly lower in power. However, all the speakers should have high enough power handling to accept the maximum output of this unit.

SPEAKER CONFIGURATION

5-Speaker Configuration

This configuration is the most effective and recommended one. In this configuration, the center speaker is necessary as well as the rear speakers. If the program **DOLBY PRO LOGIC** or **DOLBY PRO LOGIC ENHANCED** is selected, conversations will be output from the center speaker and the ambience will be excellent.

- Set the center channel mode to the “**NORMAL**” or “**WIDE**” position. (For details, refer to page 20.)

4-Speaker Configuration

The center speaker is not used in this configuration. If the program **DOLBY PRO LOGIC** or **DOLBY PRO LOGIC ENHANCED** is selected, the center sound is output from the left and the right main speakers. However, the sound effect of other programs can be the same as that of the 5-speaker configuration.

- Be sure to set the center channel mode to the “**PHANTOM**” position. (For details, refer to page 20.)

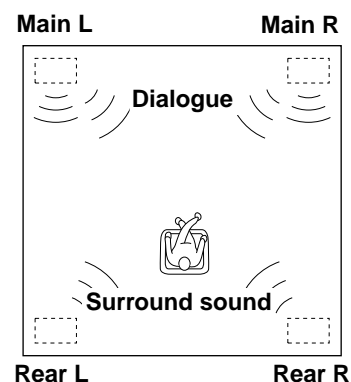
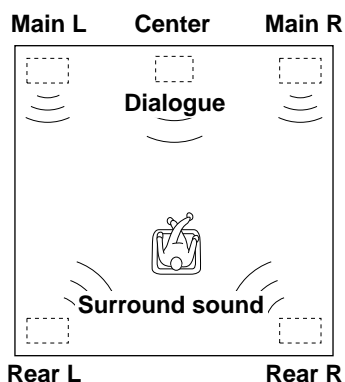

SPEAKER PLACEMENT

The recommended 5-speaker configuration requires a pair of **main speakers**, a **center speaker**, and a pair of **rear speakers** (sometimes referred to as surround speakers). When arranging your speakers, refer to the illustration and information below.

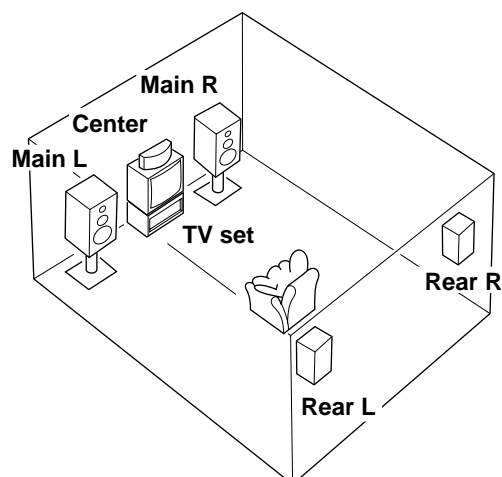

- Main:** Position the main speakers at equal distances away from the listening position and at equal distances on either side of the center speaker.
- Rear:** Position rear speakers directly behind the listening position at a height of approximately 1.8m (6 feet) from the floor, facing slightly inward. If the speakers cannot be placed behind the listening position, they may also be placed at the side of the listening position, facing toward the listening position.
- Center:** Position the center speaker directly in front of the listening position between the main speakers. (When placing on or near a television, use a magnetically shielded speaker to avoid unwanted interference.)

CONNECTIONS

CONNECTIONS WITH OTHER COMPONENTS

Never plug in this unit and other components until all connections are completed.

When making connections between this unit and other components, be sure all connections are made correctly; that is to say L (left) to L, R (right) to R, “+” to “+” and “-” to “-”. Also, refer to the owner’s manual for each component to be connected to this unit.

* If you have YAMAHA components numbered as 1, 3, 4, etc. on the rear panel, connections can be made easily by connecting the output (or input) terminals of each component to the same-numbered terminals on this unit.

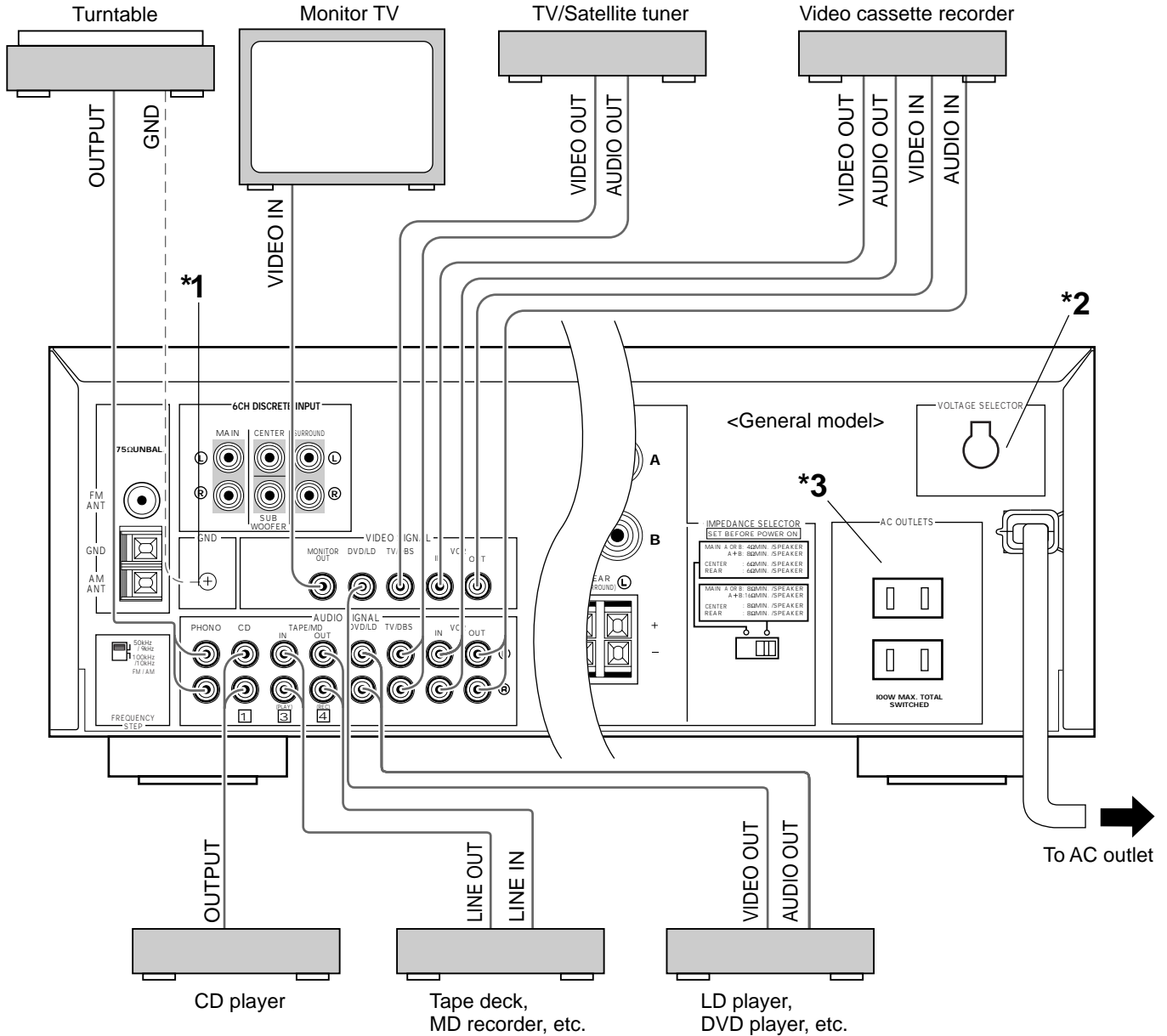

***1 Ground (GND) terminal (For turntable use)**

Connecting the ground wire of the turntable to the GND terminal will normally minimize hum, but in some cases better results may be obtained with the ground wire disconnected.

***2 Voltage Selector <China and General models only>**

The voltage selector on the rear panel of this unit must be set for your local main voltage BEFORE plugging into the AC power supply. Voltages are 110/120/220/240 V AC, 50/60 Hz.

***3 AC OUTLETS (SWITCHED)**

<Europe, Canada, U.S.A., China and General models> 2 SWITCHED OUTLETS
 <U.K. and Australia models> 1 SWITCHED OUTLET
 Use these to connect the power cords from your components to this unit.

The power to the SWITCHED AC OUTLETS is controlled by this unit’s **STANDBY/ON** switch or the provided remote control transmitter’s **POWER ⏻ / I** key. These outlets will supply power to any component whenever this unit is turned on.

The maximum power (total power consumption of components) that can be connected to the **SWITCHED AC OUTLETS** is 100 watts.

Connecting an external decoder for Dolby Digital, DTS and other future formats or a DVD player, etc.

If you have a separate Dolby Digital, DTS or other format decoder, or if you have a DVD player or other component which incorporates a Dolby Digital, DTS, or other format decoder, its 6 channel discrete outputs can be connected to the 6CH DISCRETE INPUT terminals of this unit.

(Example)

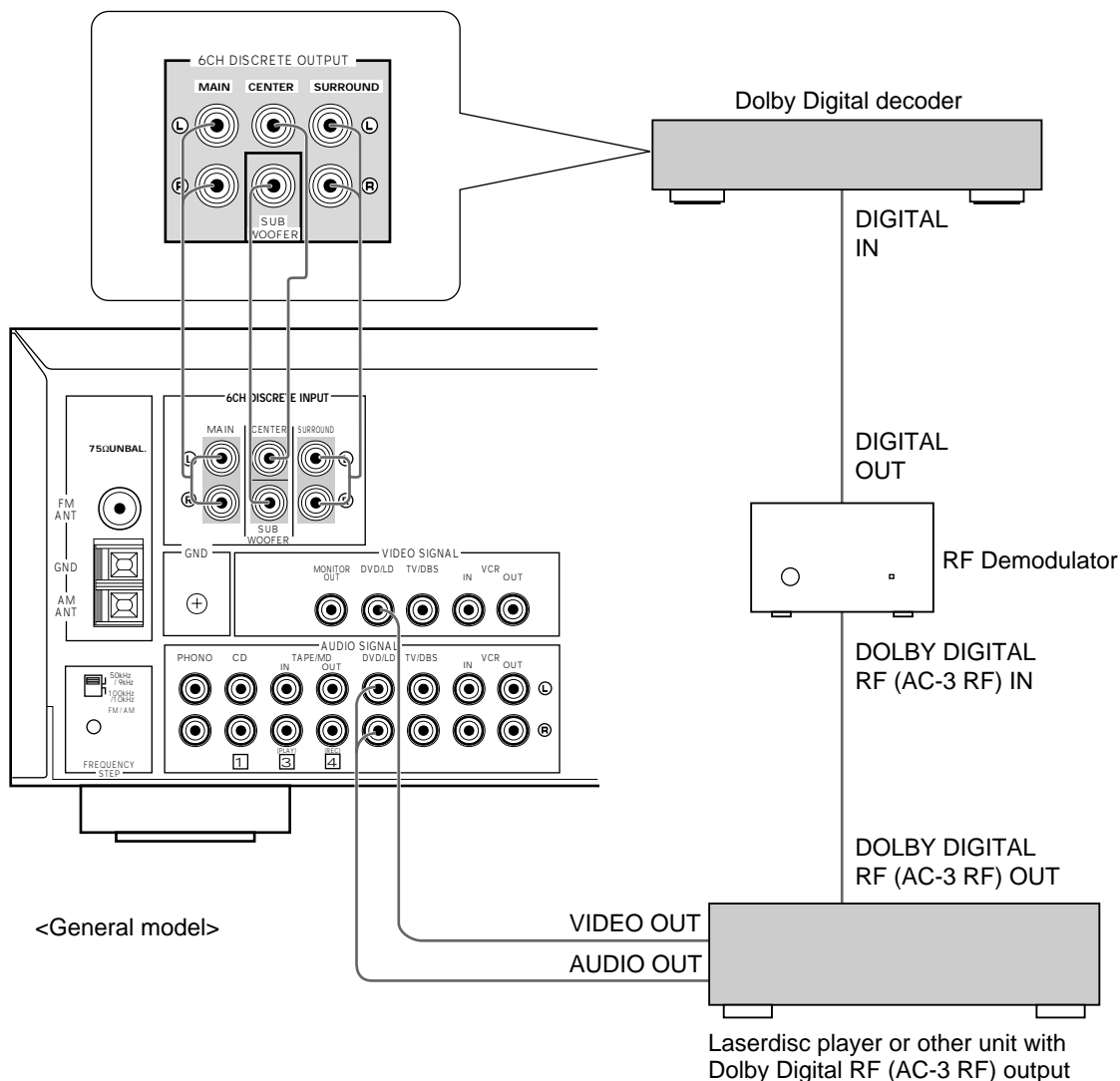

Notes

- The laserdisc player (or other unit) must be also connected to the DVD/LD (or TV/DBS) AUDIO SIGNAL input terminals of this unit to play a source encoded with Dolby Pro Logic Surround or in normal stereo (or monaural).
- The discrete signals input to this unit cannot be recorded by a tape deck, MD recorder or VCR. To record a source played on the laserdisc player (or another unit), it must be connected to the DVD/LD (or TV/DBS) AUDIO/VIDEO SIGNAL input terminals of this unit.
- If you made no connection to the SUB WOOFER input terminal of this unit or you will not use a subwoofer, you should be able to make a setting on the decoder to distribute SUB WOOFER channel signals to the right and left MAIN output terminals. For details, refer to the owner's manual supplied with the decoder.

CONNECTING SPEAKERS

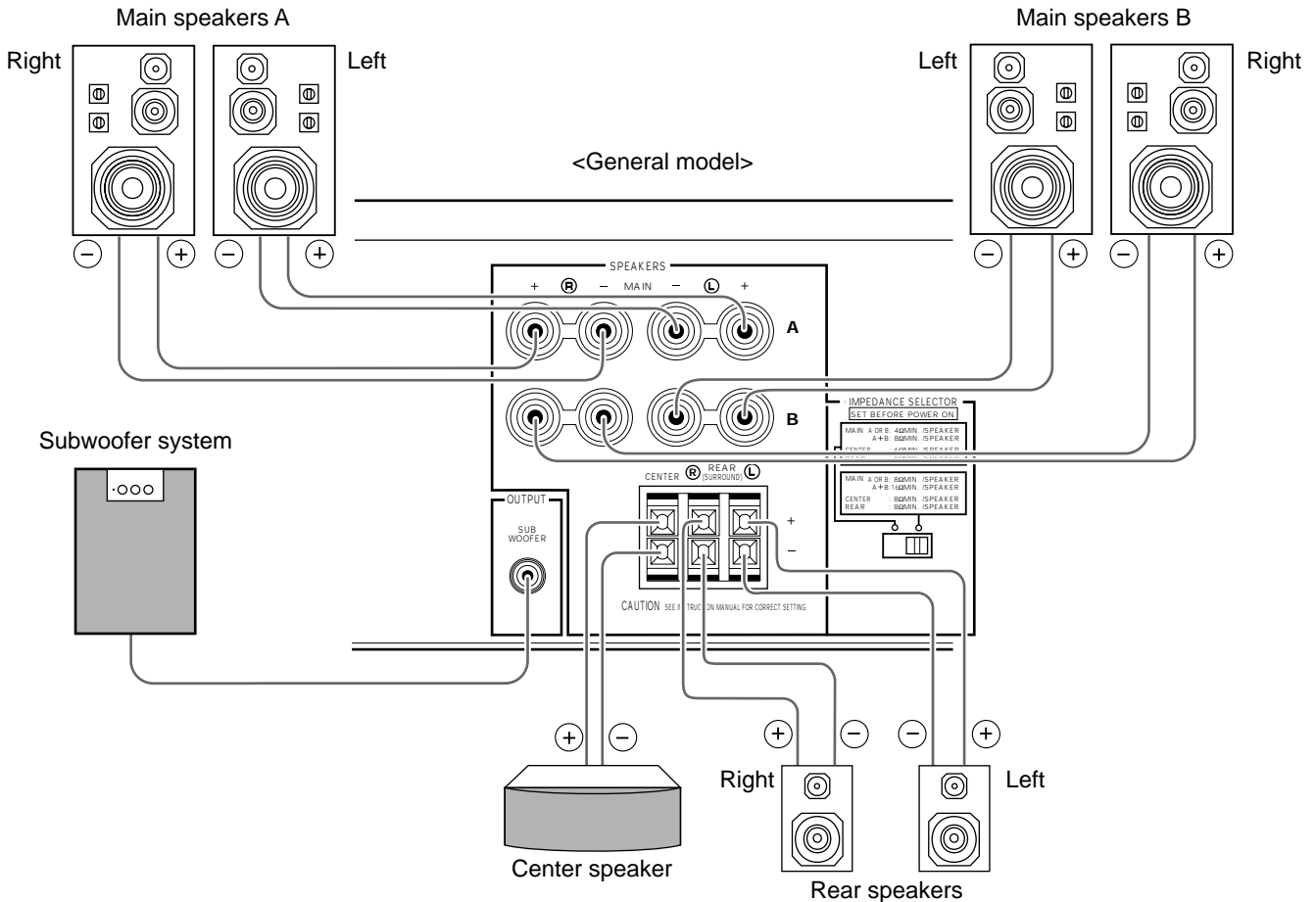

Note

Use speakers with the specified impedance shown on the rear of this unit.

Note on main speaker connections:

One or two speaker systems can be connected to this unit. If you use only one speaker system, connect it to either the **SPEAKERS A** or **B** terminals.

Note on subwoofer connection:

You may wish to add a subwoofer to reinforce low frequencies or to output low bass sound from the subwoofer channel when reproducing discrete signals.

Connect the **SUBWOOFER OUTPUT** terminal of this unit to the input terminal of the subwoofer amplifier, and connect the speaker terminals of the subwoofer amplifier to the subwoofer. With some subwoofers, including the Yamaha Active Servo Processing Subwoofer System, the amplifier and subwoofer are in the same unit.

How to Connect:

Connect the **SPEAKERS** terminals to your speakers with wire of the proper gauge, cut as short as possible. If the connections are faulty, no sound will be heard from the speakers. Make sure that the polarity of the speaker wires is correct, that is the + and – markings are observed. If these wires are reversed, the sound will be unnatural and lack bass.

Caution

Do not let the bare speaker wires touch each other or any metal part of this unit. This could damage this unit and/or speakers.

To connect to the MAIN SPEAKERS terminals

Red: positive (+)
Black: negative (–)

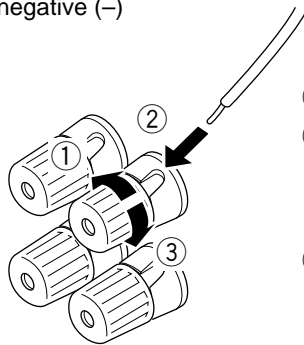

- ① Unscrew the knob.
- ② Insert the bare wire.
[Remove approx. 5mm (1/4") insulation from the speaker wires.]
- ③ Tighten the knob and secure the wire.

<U.S.A., Canada, Australia, China and General models only>

Banana Plug connections are also possible. Simply insert the Banana Plug connector into the corresponding terminal.

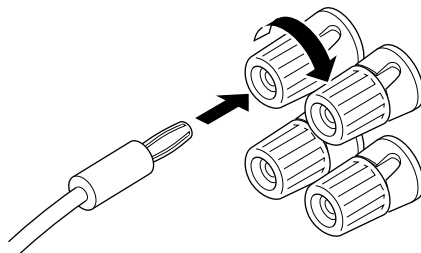

To connect to the REAR and CENTER SPEAKERS terminals

Red: positive (+)
Black: negative (–)

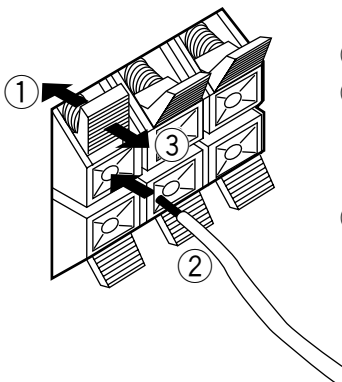

- ① Press the tab.
- ② Insert the bare wire.
[Remove approx. 5mm (1/4") insulation from the speaker wires.]
- ③ Release the tab and secure the wire.

SUBWOOFER OUTPUT terminal

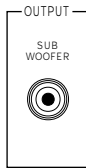

This terminal is for connecting to the input terminal of an amplifier driving a subwoofer.

This terminal outputs low frequencies from the main and center channels. (The cut-off frequency of signals output from this terminal is 150 Hz.)

When 6 channel discrete signals are input to this unit and are selected as the input source, this terminal outputs signals from the subwoofer channel.

IMPEDANCE SELECTOR switch

Be sure to switch this only when the power to this unit is not on.

Select the position whose requirements your speaker system meets.

WARNING

Do not change the IMPEDANCE SELECTOR switch setting while the power to this unit is on, otherwise this unit may be damaged.

IF THIS UNIT FAILS TO TURN ON WHEN THE STANDBY/ ON SWITCH IS PRESSED, the IMPEDANCE SELECTOR switch may not be set to either end closely. If so, set the switch to either end closely.

 (Left position)

Main: If you use one pair of main speakers, the impedance of each speaker must be 4Ω or higher.
If you use two pairs of main speakers, the impedance of each speaker must be 8Ω or higher.

Center: The impedance of the speaker must be 6Ω or higher.

Rear: The impedance of each speaker must be 6Ω or higher.

 (Right position)

Main: <Except for Canada model>
If you use one pair of main speakers, the impedance of each speaker must be 8Ω or higher.
If you use two pairs of main speakers, the impedance of each speaker must be 16Ω or higher.
<Canada model only>
The impedance of each speaker must be 8Ω or higher.

Center: The impedance of the speaker must be 8Ω or higher.

Rear: The impedance of each speaker must be 8Ω or higher.

<General model>

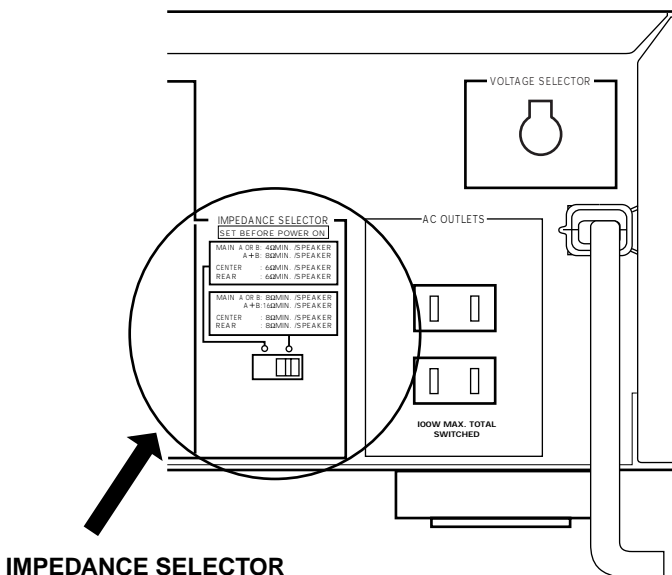

ANTENNA CONNECTIONS

- Each antenna should be connected to the designated terminals correctly, referring to the following diagram.
- Both AM and FM indoor antennas are included with this unit. In general, these antennas will probably provide sufficient signal strength. Nevertheless, a properly installed outdoor antenna will give clearer reception than an indoor one. If you experience poor reception quality, an outdoor antenna may result in improvement.

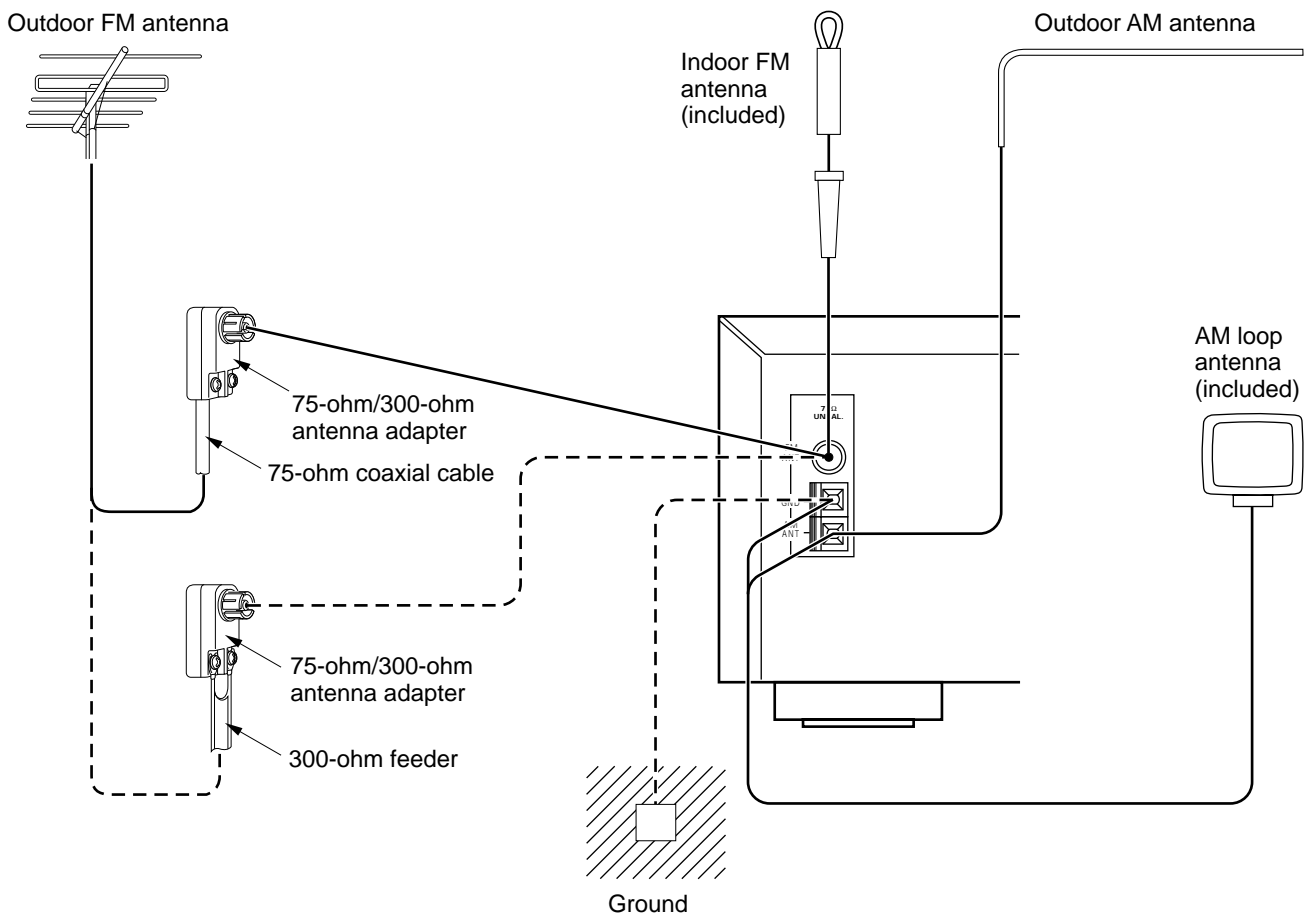

Connecting the AM loop antenna

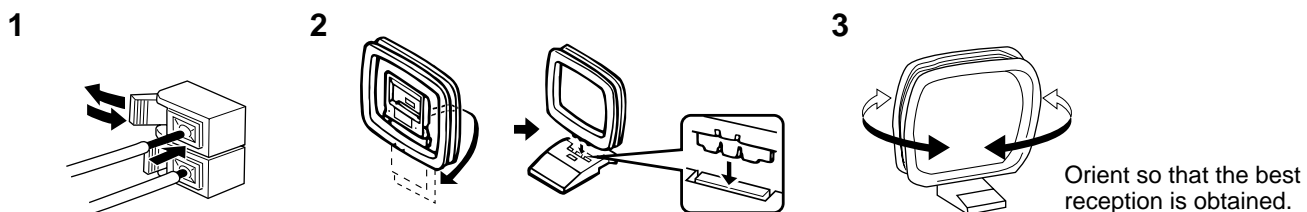

- * The AM loop antenna should be placed apart from the main unit. The antenna may be hung on a wall.
- * The AM loop antenna should be kept connected, even if an outdoor AM antenna is connected to this unit.

GND terminal

For maximum safety and minimum interference, connect the **GND** terminal to a good earth ground. A good earth ground is a metal stake driven into moist earth.

Notes

- When connecting the indoor FM antenna, insert its connector into the **FM ANT** terminal firmly.
- If you need an outdoor FM antenna to improve FM reception quality, either 300-ohm feeder or coaxial cable may be used. In locations troubled by electrical interference, coaxial cable is preferable.

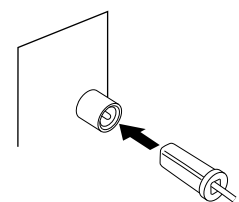

CONTROLS AND THEIR FUNCTIONS

FRONT PANEL

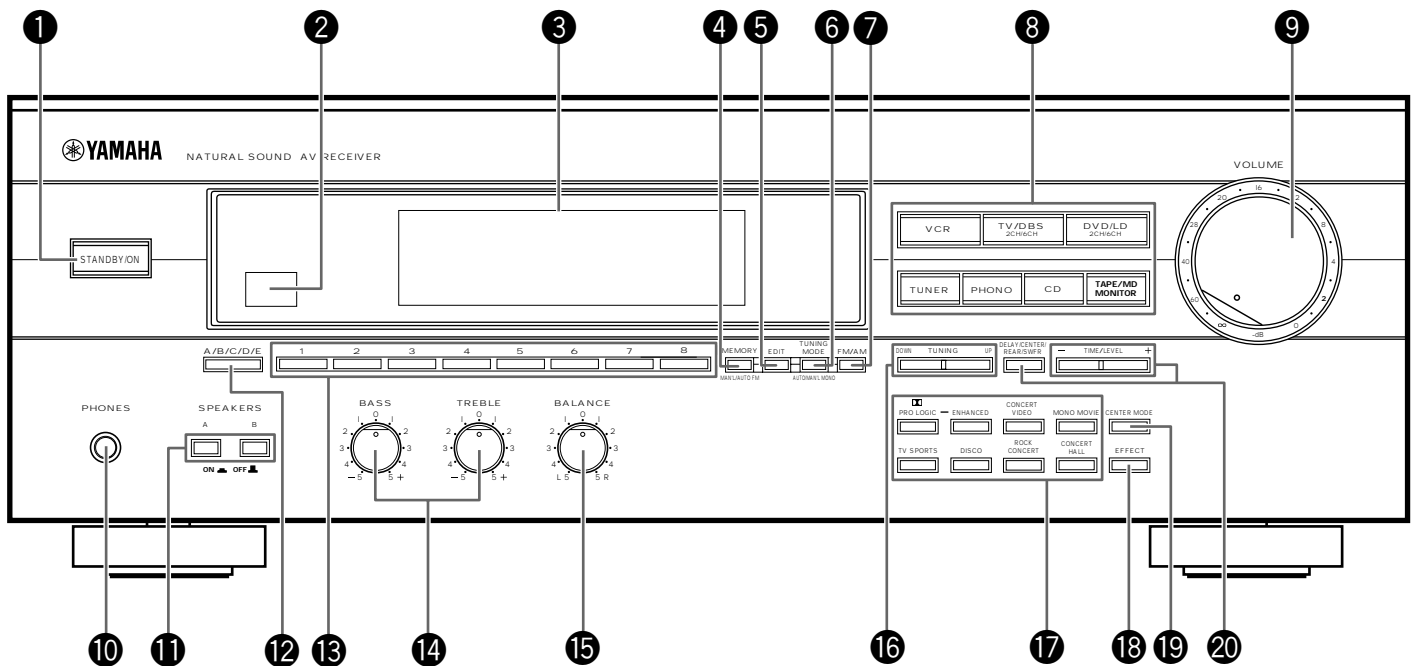

1 STANDBY/ON switch

Press this switch to turn the power to this unit on. Press it again to put this unit in the standby mode.

In STANDBY, this unit consumes a very small quantity of power to receive infrared signals from the remote control transmitter.

2 Remote control sensor

Receives signals from the remote control transmitter.

3 Display panel

Shows various information. (Refer to page 18.)

4 MEMORY (MAN'L/AUTO FM) button

Press this button to preset AM and FM radio frequencies manually. (Refer to page 27.)

When this button is pressed and held for more than 3 seconds, automatic preset tuning begins. (Refer to page 28.)

5 EDIT button

This button is used to exchange the places of two preset stations with each other. (Refer to page 29.)

6 TUNING MODE (AUTO/MAN'L MONO) button

Press this button to switch the tuning mode to automatic or manual. To select the automatic tuning mode, press this button so that the AUTO indicator lights up on the display. To select the manual tuning mode, press this button so that the AUTO indicator goes off. (Refer to page 26.)

7 FM/AM button

Press this button to switch the reception band to FM or AM. (Refer to page 26.)

8 Input selector buttons

Select a program source to listen to or watch. When a button is pressed, the name of selected source appears on the display.

When either the **TV/DBS** or **DVD/LD** input source is selected, pressing the same selector button repeatedly switches the input signals between 2 channel stereo signals and 6 channel discrete signals. When switched to "6ch", discrete signals from the unit connected to the **6CH DISCRETE INPUT** terminals of this unit are selected as the input signals.

9 VOLUME control

Use to raise or lower the volume level.

10 PHONES jack

To listen with headphones, connect the headphones to the **PHONES** jack. The sound output from the **PHONES** jack is the same as that from the main speakers.

When listening with headphones privately, set both the **SPEAKERS A** and **B** switches to the **OFF** position and switch off the digital sound field processor (so that no DSP program indicator is lit in the display) by pressing the **EFFECT** button.

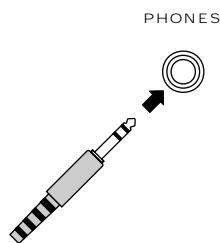
**11 SPEAKERS switches**

Set the switch **A** or **B** (or both **A** and **B**) for the main speaker system (connected to this unit) you will use to the **ON** position. Set the switch for the main speaker system you will not use to the **OFF** position. (Refer to page 25.)

12 A/B/C/D/E button

Press this button to select a desired group (A–E) of preset stations. (Refer to page 27.)

13 Preset station number selector buttons

Press to select a preset station number (1 to 8). (Refer to page 27.)

14 Tone controls

These controls are effective only for the sound from the main speakers. (Refer to page 25.)

BASS

Used to increase or decrease the low frequency response. The 0 position produces flat response.

TREBLE

Used to increase or decrease the high frequency response. The 0 position produces flat response.

15 BALANCE control

This control is effective only for the sound from the main speakers.

Adjusts the balance of the output volume to the left and right speakers to compensate for sound imbalance caused by speaker location or listening room conditions. (Refer to page 25.)

16 TUNING DOWN/UP button

Use for tuning radio stations. Press the UP side to tune in to higher frequencies, and press the DOWN side to tune in to lower frequencies.

17 DSP program selector buttons

Select a DSP program. When a button is pressed, the name of selected program lights up on the display. (Refer to page 36.)

18 EFFECT button

Switches the digital sound field processor on and off (including the Dolby Pro Logic Surround decoder). (Refer to page 37.)

19 CENTER MODE button

Selects a center channel output mode (NORMAL, WIDE or PHANTOM). (Refer to page 20.)

20 DELAY/CENTER/REAR/SWFR and TIME/LEVEL +/- buttons

Adjust the delay time (DELAY), the center channel output level (CENTER), the rear channel output level (REAR) and the output level to the **SUBWOOFER OUTPUT** terminal (SWFR). Select the item which you want to adjust by pressing the **DELAY/CENTER/REAR/SWFR** button and adjust its time or level by pressing the **TIME/LEVEL +/-** button. (Refer to pages 25, 38, and 39.)

REMOTE CONTROL TRANSMITTER

The remote control transmitter provided with this unit is designed to control all the most commonly used functions of this unit as well as the components connected to it. The remote control transmitter is factory set to control this unit and most Yamaha components. To set up the remote control transmitter to control the components of other manufacturers, refer to "SETUP CODES" on page 41.

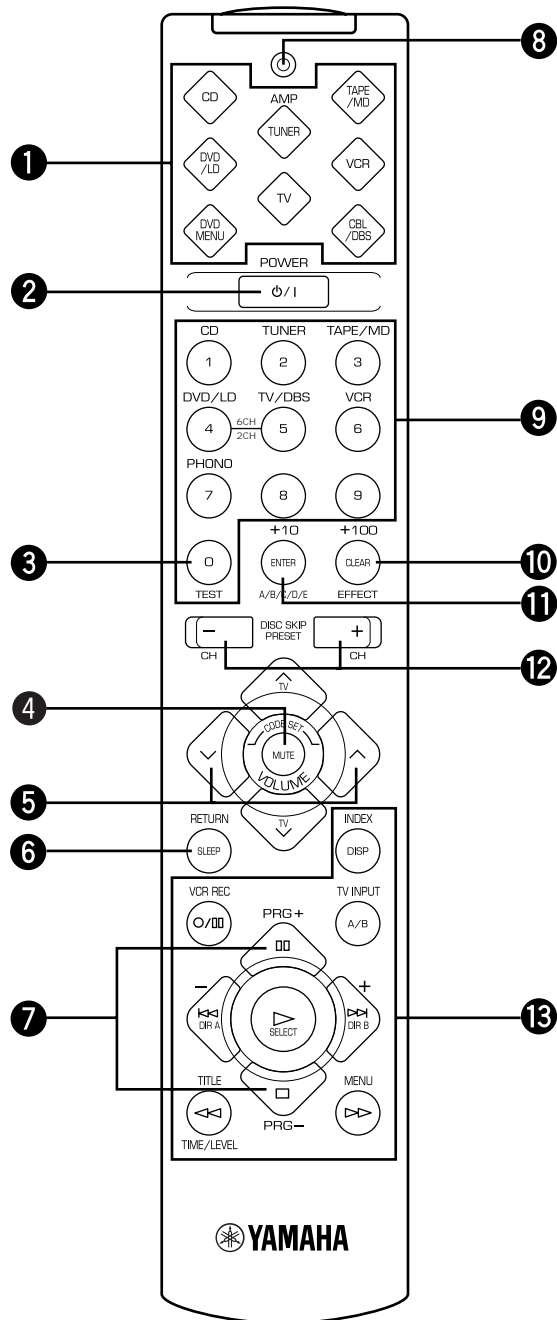

1 Component selector

Press the button for the component you want to control with the remote control transmitter. (The proper code must be set for your component. See "SETUP CODES" on page 41.)

When the component selector has been pressed, the remote control transmitter is set to operate that component.

2 POWER ϕ / I

When you have preset the code for a YAMAHA component, this button switches between the power on and standby mode.

When you have preset the code for another manufacturer's component, this button turns on that component if it has a remote control transmitter with a power button.

* Functions only when the component selector button **AMP<TUNER>**, **TAPE/MD**, **CD**, **DVD/LD** or **DVD MENU** has been pressed.

3 TEST

Press this button to output the test tone for each speaker.

* Functions only when the component selector button **AMP<TUNER>** has been pressed.

4 MUTE

Press this button to mute the sound.

5 VOLUME

These buttons are used to adjust the volume.

∧: Turns up the volume.

∨: Turns down the volume.

6 SLEEP

This button is used to set the SLEEP timer.

7 PRG+, PRG-

These buttons are used to select a DSP program.

* Function only when the component selector button **AMP<TUNER>** has been pressed.

8 Indicator

This flashes in red when a button on the remote control transmitter is pressed. When it flashes rapidly several times, press the selected button again.

9 Input selector (1 to 7)¹⁾ / Numeric buttons²⁾

1) These buttons are used to select the program source to be played.

* Function only when the component selector button **AMP<TUNER>**, **TAPE/MD**, **CD** or **DVD/LD** has been pressed.

2) These buttons are used to select the menu or channel.

* Function only when the component selector button **DVD MENU**, **VCR**, **CBL/DBS** or **TV** has been pressed.

10 EFFECT¹⁾ / CLEAR²⁾ / +100³⁾

1) This button is used to switch the DSP program on or off.

* Functions only when **AMP<TUNER>**, **TAPE/MD**, **CD**, **DVD/LD**, **VCR** or **TV** on the component selector has been pressed.

2) This button is used to clear the settings.

* Functions only when the component selector button **DVD MENU** has been pressed.

3) This button is used to select the channel.

* Functions only when the component selector button **CBL/DBS** has been pressed.

11 ENTER¹⁾ / +10²⁾ / A/B/C/D/E³⁾

1) This button is used to enter the channel.

* Functions only when the component selector button **VCR**, **CBL/DBS** or **TV** has been pressed.

2) This button is used to select the menu.

* Functions only when the component selector button **DVD MENU** has been pressed.

3) This button is used to select a group of presets.

* Functions only when the component selector button **AMP<TUNER>** has been pressed.

12 DISC SKIP +/-¹⁾ / CH +/-²⁾ / PRESET +/-³⁾

1) These buttons are used to skip to the next or previous disc.

* Function only when the component selector button **CD**, **DVD/LD** or **DVD MENU** has been pressed.

2) These buttons are used to select the next or previous channel.

* Function only when the component selector button **VCR**, **CBL/DBS** or **TV** has been pressed.

3) These buttons are used to select a preset station.

* Functions only when the component selector button **AMP<TUNER>** has been pressed.

13 Operation buttons¹⁾ / Setup buttons²⁾

1) These buttons function as play, stop, skip, etc. for operating the component.

* Function only when the component selector button **TAPE/MD**, **CD**, **DVD/LD**, **VCR** or **TV** has been pressed.

2) These buttons are for adjusting various settings.

* Function only when the component selector button **DVD MENU** or **CBL/DBS** has been pressed.

DISPLAY PANEL

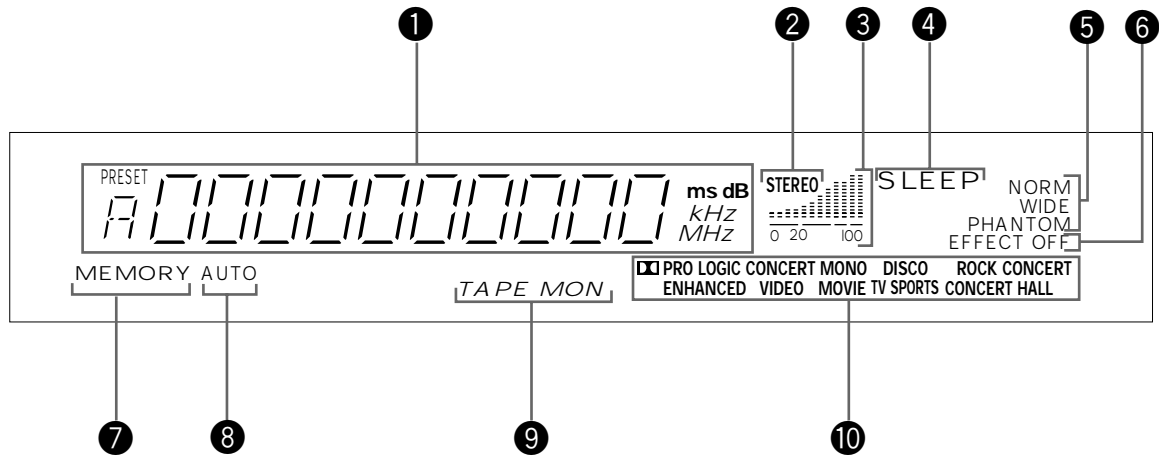

1 Multi-information display

Displays various information, for example station frequency, preset station number and name of selected input source.

2 STEREO indicator

Lights up when an FM stereo broadcast with sufficient signal strength is received.

3 Signal-level meter

Indicates the signal level of the received station. If multipath interference is detected, the indication decreases.

4 SLEEP indicator

Lights up while the built-in SLEEP timer is functioning.

5 Center channel mode indicators

The name of a selected center channel mode lights up only when a program which uses Dolby Pro Logic Surround is selected.

6 EFFECT OFF indicator

Lights up if neither the digital sound field processor nor the Dolby Pro Logic Surround decoder is on. In this state, sound output is 2-channel stereo.

7 MEMORY indicator

When the **MEMORY** button is pressed, this indicator flashes for about 5 seconds. During this period, the displayed station can be programmed to the memory by using the **A/B/C/D/E** button and the preset station number selector buttons.

8 AUTO indicator

Lights up when this unit is in the automatic tuning mode.

9 TAPE MON indicator

Lights up when the tape deck (or MD recorder, etc.) is selected as the input source by pressing the **TAPE/MD MONITOR** button.

10 DSP program indicators

The name of a selected DSP program lights up when the built-in digital sound field processor or the Dolby Pro Logic Surround decoder is on.

SPEAKER BALANCE ADJUSTMENT

This procedure lets you adjust the sound output level balance between the main, center, and rear speakers using the built-in test tone generator. When this adjustment is performed, the level heard at the listening position should sound the same from each speaker. This is important for the best performance of the digital sound field processor and the Dolby Pro Logic Surround decoder.

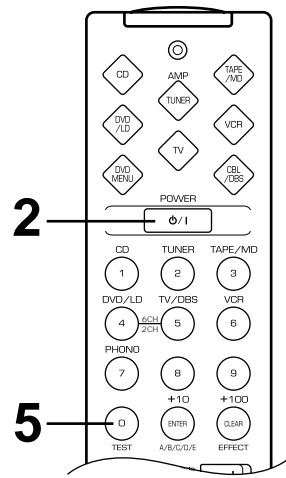
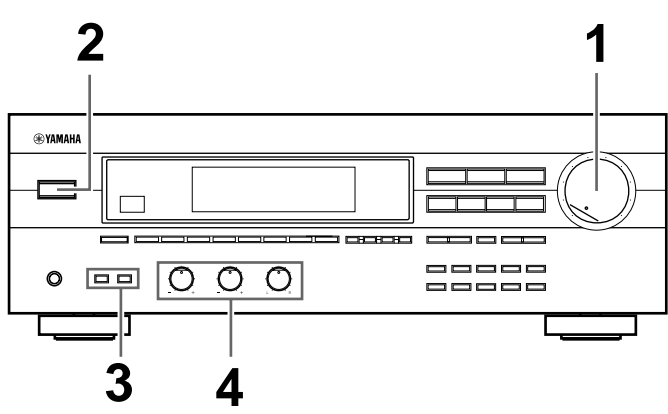

Press the component selector button **AMP<TUNER>** on the remote control transmitter.

3 Select the main speakers to be used.

* If you use two main speaker systems, press both the A and B switches.

1

Set **VOLUME** to the minimum level ($-\infty$ dB).

4

Set **BASS**, **TREBLE** and **BALANCE** to the "0" position.

2 Turn the power on.

5 Press the **TEST** button so that "TEST LEFT" appears in the display.

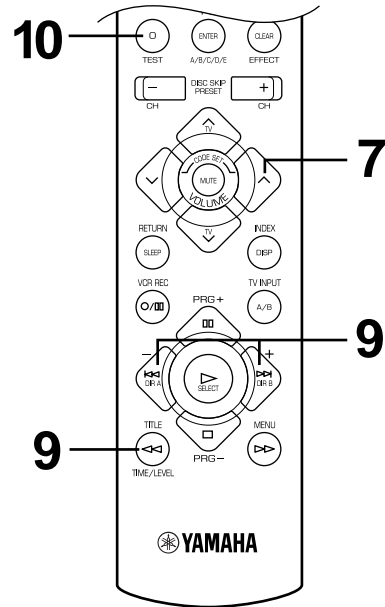
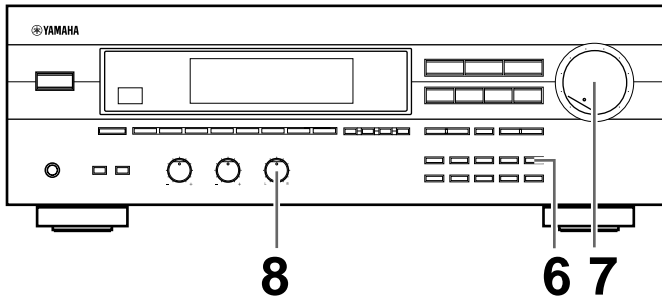

6 Select the center channel output mode suitable for your speaker configuration.
(Refer to **"SPEAKER CONFIGURATION"** on page 7.)

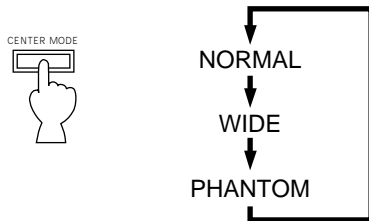

On the feature of each mode, refer to the **"Note"** shown below.

Note

In step 6, when you select a center channel output mode, note the following.

For 5 speaker configuration

NORMAL: Select this mode when you use a center speaker that is smaller than the main speakers. In this mode, the bass tone will be output from the main speakers.

WIDE: Select this mode when you use a center speaker approximately the same size as the main speakers.

For 4 speaker configuration

PHANTOM: Select this mode when you do not use the center speaker. The center speaker sound will be output from the left and right main speakers.

7 Turn up the volume.

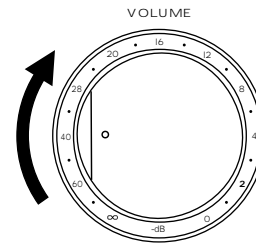

You will hear a test tone (like pink noise) in order from the left main speaker, the center speaker, the right main speaker, and then the rear speakers for about two seconds each. The display changes as shown below.

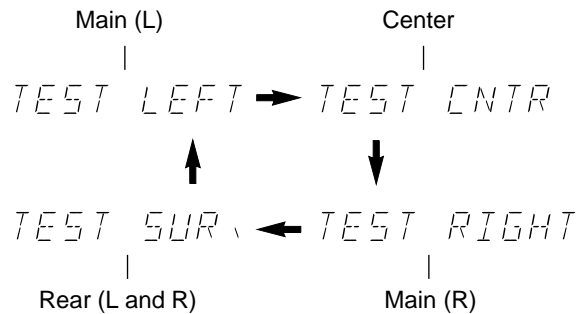

* The test tone from the left rear speaker and the right rear speaker will be heard at the same time.

8 Adjust the **BALANCE** control so that the sound output level of the left main speaker and the right main speaker are the same.



- 9** Adjust the sound output levels of the center speaker and the rear speakers so that they sound as similar as possible to the level of the main speakers.

Make the adjustment of each speaker output level at your listening position with the remote control transmitter.

- a) Press the **TIME/LEVEL** button once or more so that "CENTER" or "REAR" appears on the display.
 - * Select "CENTER" to adjust the output level of the center speaker, and select "REAR" to adjust the output level of the rear speakers.
- b) Press the **+** and **-** operation buttons to adjust the level.

- 10** Press the **TEST** button again to cancel the test tone.

Notes

- Once you have completed these adjustments, you can adjust the overall sound level of your audio system by using the **VOLUME** control (or the **VOLUME** keys on the remote control transmitter) only.
- If you use external power amplifiers, you may also use their volume controls to achieve proper balance.
- In step 9, if the center channel mode is in the "PHANTOM" position, the sound output level of the center speaker cannot be adjusted, because the center sound is automatically output from the left and right main speakers.

This manual describes how to operate this unit mainly by using the front panel control parts.
To operate this unit on the remote control transmitter, use the corresponding keys on the remote control transmitter.

BASIC OPERATIONS

TO PLAY A SOURCE

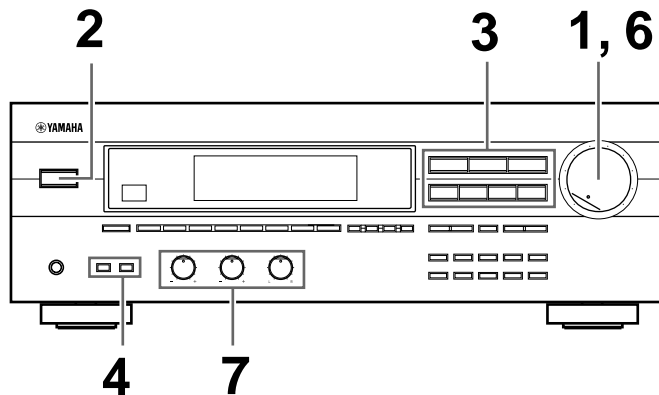

1

Set **VOLUME** to the minimum level ($-\infty$ dB).

2 Turn the power on.

3 Select the desired input source by using the input selector buttons.
(For video sources, turn the TV/monitor ON.)

* The name of the selected input source will appear on the display.

4 Select the main speakers to be used.

* If you use two main speaker systems, press both the A and B switches.

5 Play the source. (For detailed information on tuning operations, refer to page 26.)

6

Adjust to the desired output level.

7 If desired, adjust **BASS**, **TREBLE** and **BALANCE** (refer to page 25), and/or use the digital sound field processor. (Refer to page 37.)

Notes on using the input selector buttons

- Note that pressing each input selector button selects the source which is connected to the corresponding input terminals on the rear panel.
- The selection of **TAPE/MD MONITOR** cannot be canceled by pressing another input selector button. To cancel it, press **TAPE/MD MONITOR** again so that the TAPE MON indicator disappears from the display.
When you select a button other than **TAPE/MD MONITOR**, make sure that the TAPE MON indicator is not illuminated on the display.
- If you select the input selector button for a video source without canceling the selection of **TAPE/MD MONITOR**, the playback result will be the video image from the video source and the sound from the audio tape (or MD, etc.).
- Once you play a video source, its video image will not be interrupted even if the input selector button for an audio source is selected.

When you finish using this unit

Press the **STANDBY/ON** switch on the front panel again or the **POWER** ϕ **I** key on the remote control transmitter to put this unit in the standby mode.

To listen to a source with Dolby Digital, DTS or other future format by reproducing the decoded signals input at the 6CH DISCRETE INPUT terminals of this unit.

In step 3 on page 22, press either the DVD/LD or TV/DBS button once or more so that "6ch" appears in the display. Discrete signals from the component connected to the **6CH DISCRETE INPUT** terminals of this unit are selected as the input signals.

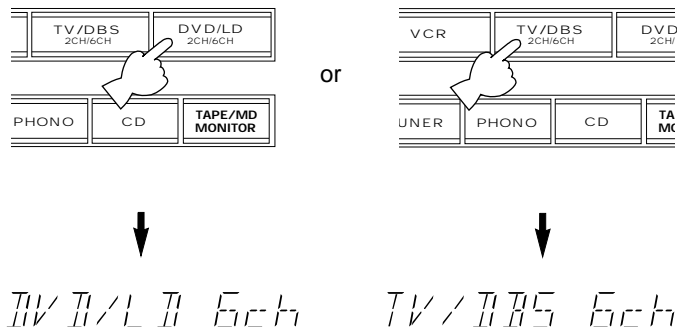

To stop listening to a decoded source with Dolby Digital, DTS, or other future format

Press the DVD/LD or TV/DBS button again to switch the input from six channel input to two channel input or select another input source. When two channel input is selected, the **6CH DISCRETE INPUT** terminals are not used.

Notes on reproducing discrete signals with Dolby Digital, DTS, or other future format:

1. Your speaker system must include a center speaker.
2. Your speaker system should include a subwoofer.
 - * Connect a subwoofer which has a built-in amplifier directly to the **SUBWOOFER OUTPUT** terminal of this unit. For more details on hooking up a subwoofer to this unit, refer to pages 10 and 12.
 - * If you do not have a subwoofer in your system, it may be possible to make a setting on the Dolby Digital, DTS, or other future format decoder to distribute LFE channel signals to the right and left MAIN output terminals. For details, refer to the owner's manual supplied with your decoder.

Notes

- When you switch to the "6ch" mode, the built-in digital sound field processor (DSP) will not work and adjustments to delay time settings cannot be made.
- Switching this unit to the "6ch" mode will input no signal to this unit if there is no connection made to the **6CH DISCRETE INPUT** terminals of this unit.

TO RECORD A SOURCE TO TAPE OR MD

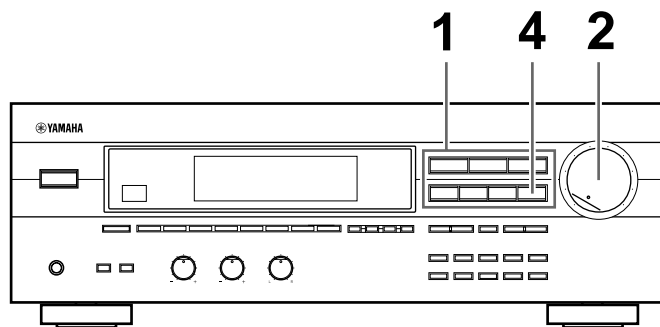

- 1** Select the source to be recorded.

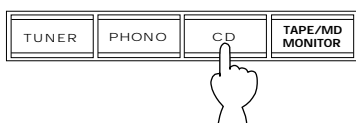

- 2** Play the source and then turn the **VOLUME** control up to confirm the input source. (For detailed information on tuning operations, refer to the page 26.)

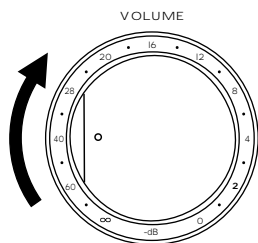

- 3** Begin recording on the tape deck (or MD recorder, etc.) or VCR connected to this unit.

- 4** If the tape deck (or MD recorder, etc.) is used for recording, you can monitor the sounds being recorded by pressing **TAPE/MD MONITOR** so that the "TAPE MON" indicator lights up on the display.

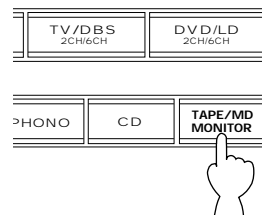

Notes

- The settings of DSP and the **VOLUME**, **BASS**, **TREBLE** and **BALANCE** controls have no effect on the material being recorded.
- In step 1, do not make an input source selection so that "6ch" appears on the display. Signals input to this unit's **6CH DISCRETE INPUT** terminals cannot be recorded by a tape deck, MD recorder or VCR.

Selecting the SPEAKER system

Because one or two speaker systems (as main speakers) can be connected to this unit, the **SPEAKERS** switches allow you to select speaker system **A** or **B**, or both at once.

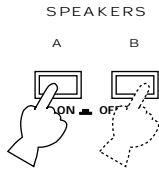

Adjusting the BALANCE control

Adjust the balance of the output volume to the left and right speakers to compensate for sound imbalance caused by speaker location or listening room conditions.

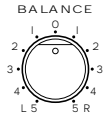

Note
This control is effective only for the sound from the main speakers.

Adjusting the subwoofer output level

If your audio system includes a subwoofer, and an amplifier driving the subwoofer (or a subwoofer system including an amplifier) is connected to the **SUBWOOFER OUTPUT** terminal on the rear of this unit, you can adjust the subwoofer output level on this unit.

1 Press once or more so that "SWFR" appears on the display.

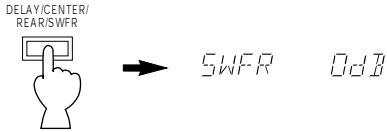

2 By continuously pressing the "+" or "-" side of the **TIME/LEVEL** button, the level value changes continuously. If you feel that bass tone is insufficient, increase the level, and if you feel that bass tone is overly emphasized, decrease the level.

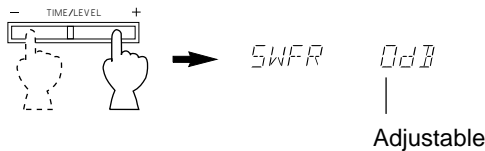

Control range: MIN, -20 to 0 dB

Adjusting the BASS and TREBLE controls

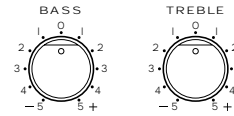

BASS : Turn this clockwise to increase (or counterclockwise to decrease) the low frequency response.

TREBLE : Turn this clockwise to increase (or counterclockwise to decrease) the high frequency response.

Note
These controls are effective only for the sound from the main speakers.

TUNING OPERATIONS

Normally, if station signals are strong and there is no interference, quick automatic-search tuning (AUTOMATIC TUNING) is possible. However, if signals of the station you want to select are weak, you must tune to it manually (MANUAL TUNING).

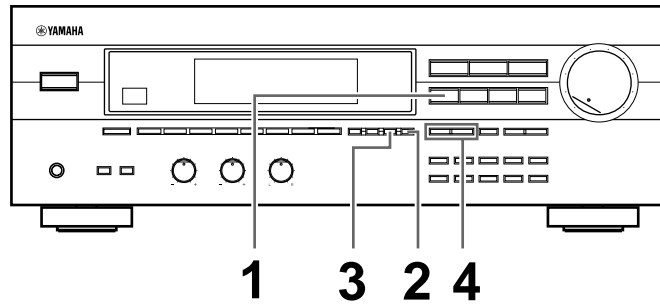

AUTOMATIC TUNING

- 1** Select "TUNER" as the input source.



- 2** Select the reception band (FM or AM) confirming it in the display.

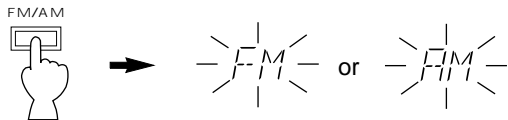

- 3** To tune to a higher frequency, press the right side once. To tune to a lower frequency, press the left side once.

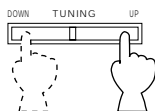
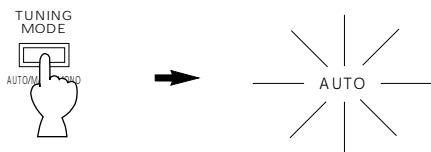

- * If the station where tuning search stops is not the desired one, press again.
- * If the tuning search does not stop at the desired station (because the signals of the station are weak), change to the MANUAL TUNING method.

MANUAL TUNING

- 1** Select "TUNER" as the input source.

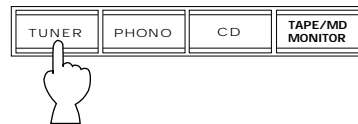

- 2** Select the reception band (FM or AM) confirming it in the display.



- 3** Turn the "AUTO" indicator off.

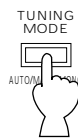

- 4** Tune to a desired station manually.

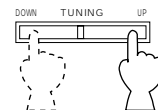

- * For a continuous tuning search, press and hold the button.

Note
If you tune to an FM station manually, it is received in monaural mode automatically to increase the signal quality.

PRESET TUNING

MANUAL PRESET TUNING

This unit can store station frequencies selected by tuning operation. With this function, you can recall any desired station by selecting the preset station number where it is stored. Up to 40 stations (5 groups of 8 stations) can be stored.

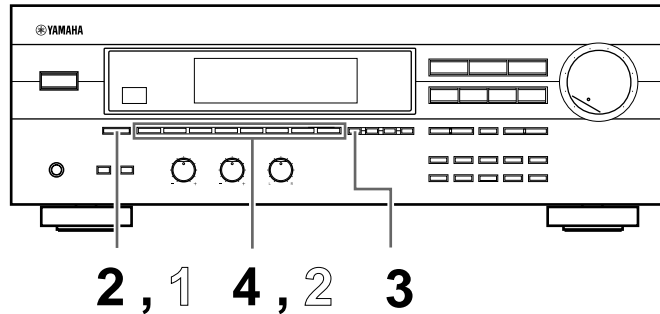

To store stations

1 Tune to a desired station.
(Refer to the previous page for tuning procedure.)

2 Select a desired group (A – E) of preset stations confirming it in the display.

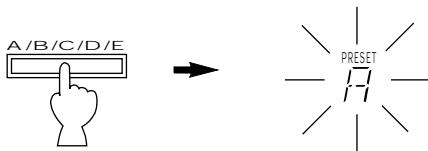

3 **MEMORY** indicator flashes on and off for about 5 seconds.

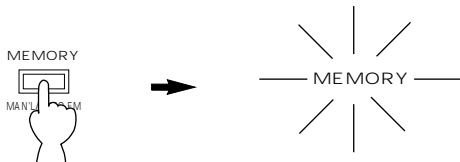

4 Select a preset station number where you want to program the station while the "MEMORY" indicator appears in the display.

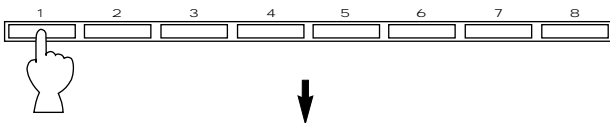

Shows the displayed station has been programmed to A1.

- * In the same way, program other stations to A2, A3 ... A8.
- * You can program more stations to preset station numbers on other groups in the same way by selecting other groups in step 2.

To recall a preset station

1 Select the group of preset stations.

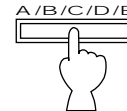

2 Select the preset station number.

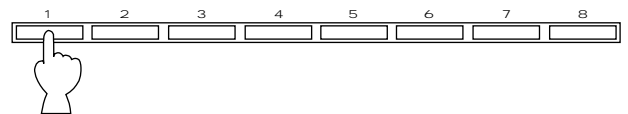

Notes

- A new setting can be programmed to replace a former setting.
- For presets, the setting of the reception mode (stereo or monaural) is stored along with the station frequency.

Memory back-up



The memory back-up circuit prevents the programmed data from being lost even if this unit is put in the standby mode, the power plug is disconnected from the AC outlet, or the power is cut due to temporary power failure. If, however, the power is cut for more than one week, the memory may be erased. If so, it can be re-programmed by simply following the PRESET TUNING steps.

AUTOMATIC PRESET TUNING

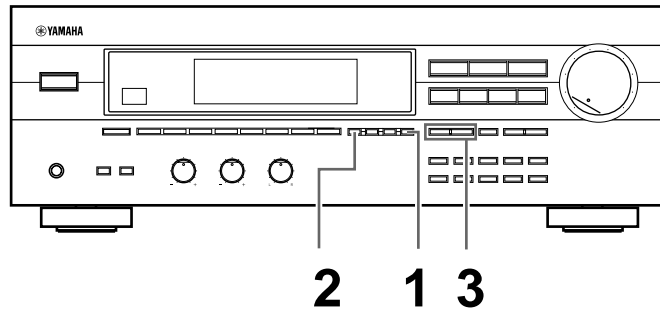
You can also make use of an automatic preset tuning function for FM stations only. With this function, this unit performs automatic tuning and stores stations with strong signals sequentially. Up to 40 stations are stored automatically in the same way as in the manual preset tuning method on page 27.

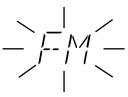

To store stations

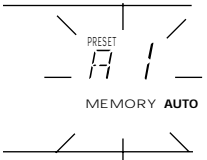
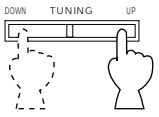
1	 → 
2	 →  Press and hold for more than 3 seconds. Flashes.
3	 To tune to higher frequencies, press right side once. To tune to lower frequencies, press left side once. * If the TUNING button is not pressed for a while, automatic preset tuning begins automatically toward higher frequencies. Automatic preset tuning begins from the frequency currently displayed. Received stations are programmed to A1, A2 ... A8 sequentially. * If more than 8 stations are received, they are programmed to the preset station numbers in other groups in alphabetical order.

When the automatic preset tuning concludes

The display shows the frequency of the last preset station. Check the contents and the number of preset stations by following the procedure of the section "To recall a preset station" on page 27.

To recall a preset station

Follow the procedure in the section "To recall a preset station" on page 27.

* A recalled station is shown by the frequency in the display.

Notes

- You can replace a preset station with another FM or AM station manually by following the procedure in the section "To store stations" on page 27.
- If the number of received stations is not enough to be stored up to E8, the search is finished automatically after searching all frequencies.
- With this function, only stations with sufficient signal strength are stored automatically. If the station you want to program is weak in signal strength, tune to it in monaural manually and program it by following the procedure in the section "To store stations" on page 27.

If you want to store the first station received by the automatic preset tuning to a desired preset station number.

If, for example, you want to store the first received station to C5, select "C5" by using the **A/B/C/D/E** button and the preset station number selector buttons after pressing the **MEMORY** button in step 2. Then press the **TUNING** button. The first received station is stored to C5, followed by C6, C7, etc. in sequence.

If stations are stored up to E8, the automatic preset tuning is automatically concluded.

EXCHANGING PRESET STATIONS

You can exchange the places of two preset stations with each other as shown below.

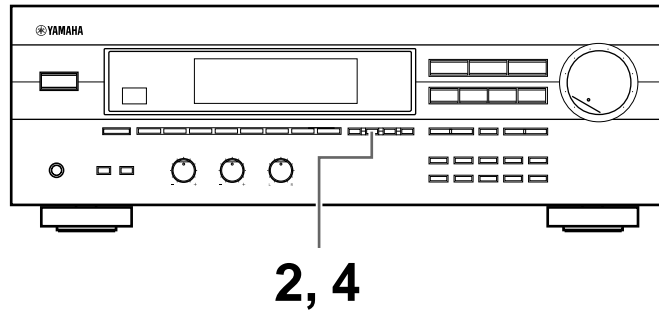

Example)

If you want to shift the preset station on E1 to A5, and vice versa.

1	Recall the preset station on E1 (by following the method in "To recall a preset station" on page 27).
2	<p>Flashes.</p>
3	Next, recall the preset station on A5 by following the same method as step 1. <p>Flashes.</p>

4	<p>Shows the exchange of stations is completed.</p>
----------	---

REMOTE CONTROL TRANSMITTER

You can use the remote control transmitter to control not only this unit but also other components connected to it. The remote control transmitter is factory set to control this unit and most YAMAHA audio components. To control the components of other manufacturers, you must preset the remote control transmitter using the procedure on page 41 and the manufacturers' codes listed on pages 87 to 91.

Components which can be controlled

There are eight buttons on the component selector that you can select to control connected components with this remote control transmitter. For example, if CD on the component selector is pressed, the remote control transmitter selects the CD operation mode, allowing the CD player to be operated by the buttons on the remote control transmitter.

AMP<TUNER>

You can perform the basic operations of this unit, set the speaker level, and set the DSP level and delay time in the AMP<TUNER> mode.

CD

The code for a YAMAHA CD player is preset.

DVD/LD & DVD MENU

An LD player can be controlled in the DVD/LD mode. A DVD player can be controlled in the DVD/LD and DVD MENU modes. The code for a YAMAHA DVD player is preset. If the remote control transmitter will not operate your YAMAHA DVD player, you need to preset code number "0048".

TAPE/MD

The code for a YAMAHA tape deck is preset. (The code for the YAMAHA MD recorder can also be preset.)

VCR

A VCR can be controlled.

CBL/DBS

A cable television or DBS tuner can be controlled.

TV

A television can be controlled.

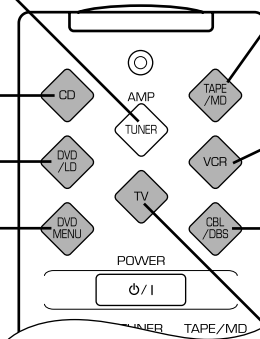

Notes

- You can preset the code for the manufacturer of your component after pressing the shaded buttons in the illustration above. Note that you can preset only one code for each mode. See "SETUP CODES" on page 41 for details.
- In the DVD/LD and DVD MENU modes:
 - * Be sure to press the component selector button **DVD/LD** on before presetting the code for the DVD/LD player. The code preset in the DVD/LD mode is also simultaneously preset in the DVD MENU mode. You cannot preset the code for a DVD player in the DVD MENU mode.
 - * DVD MENU operations cannot be performed for some DVD players.
- When using a second (and third) VCR: (See "To use a second (and third) VCR" on page 41 for details.)
 - * If you are not using a CBL/DBS (cable TV or DBS tuner), the second (or third) VCR can be preset in the CBL/DBS mode.
 - * If you are not using a DVD player, the second (or third) VCR can be preset in the DVD MENU mode. Note that in this case you must preset the code for an LD player in the DVD/LD mode even if an LD player is not being used.

The lightly marked buttons do not function.

AMP<TUNER> MODE

Press **AMP<TUNER>**.

POWER

Each time this button is pressed, the unit will switch between the power on and standby modes.

TEST

This button outputs a test tone for adjusting the output levels of the speakers.

A/B/C/D/E & PRESET +/-

These buttons select a preset FM or AM broadcast.

A/B/C/D/E: To select a group of preset stations.

PRESET +/-: To select the preset station number.

MUTE

This button mutes the sound. To cancel mute, press this button once more, or press any operation buttons of this unit.

VOLUME (^ v)

These buttons adjust the volume level.

SLEEP

This button sets the SLEEP timer.

+/-

These buttons adjust the settings of the TIME/LEVEL mode.

TIME/LEVEL

This button selects the item in the TIME/LEVEL mode.

Input selector

These buttons select the program source.

CD: To play a CD
TUNER: To listen to an FM or AM broadcast

TAPE/MD: To play a tape or MD

DVD/LD: To play a DVD or LD

TV/DBS: To watch a television or satellite broadcast

VCR: To play a video tape

PHONO: To play an analog record

EFFECT

This button switches the DSP program on or off.

TV VOLUME

TV INPUT

PRG+/PRG-

These buttons select a DSP program.

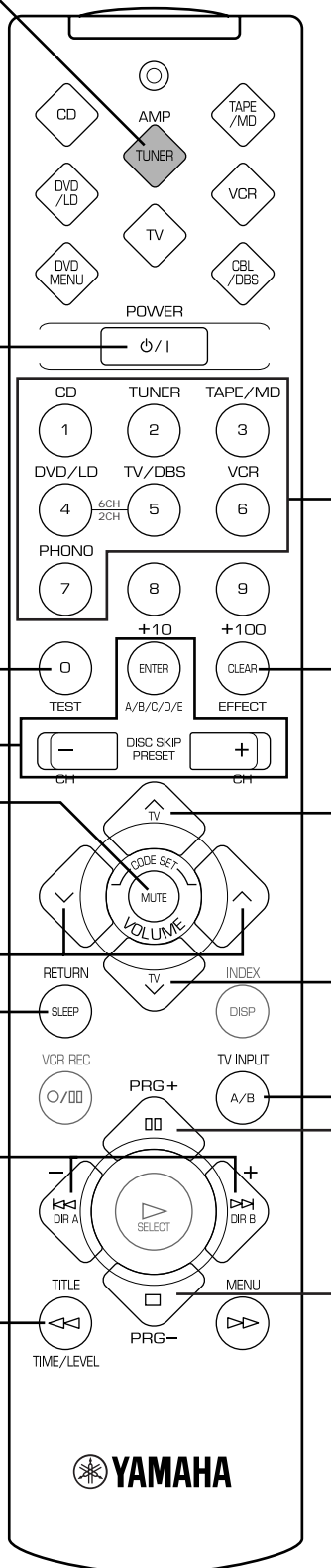

Note

TV VOLUME and TV INPUT function if you have preset the code for your TV.

The lightly marked buttons do not function. Please refer to the owner's manual for details of each component.

■ TAPE/MD MODE

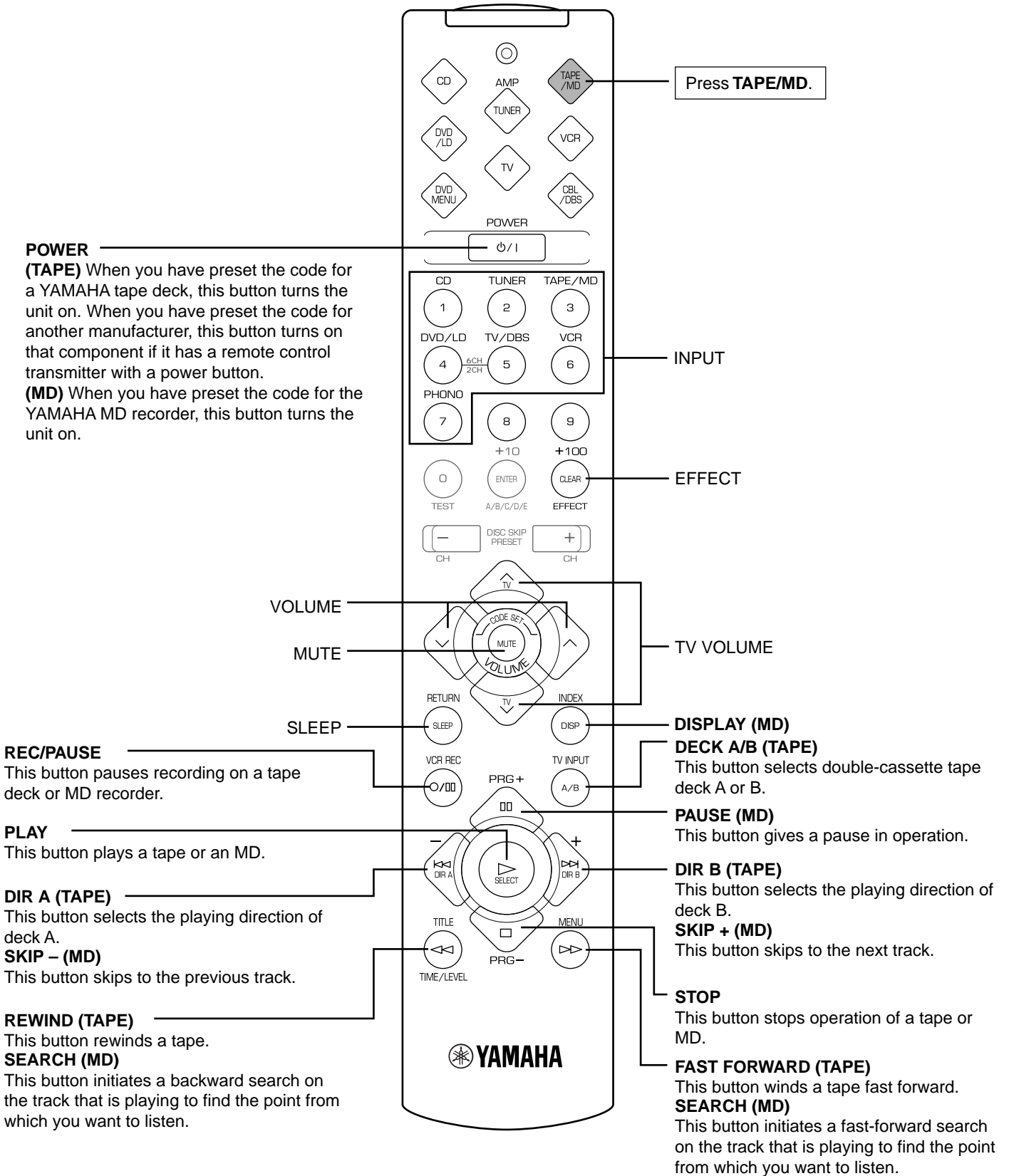

Notes

- **TV VOLUME** function if you have preset the code for your TV.
- The code for the YAMAHA MD recorder can be preset.

The lightly marked buttons do not function. Please refer to the owner's manual for details of each component.

CD MODE

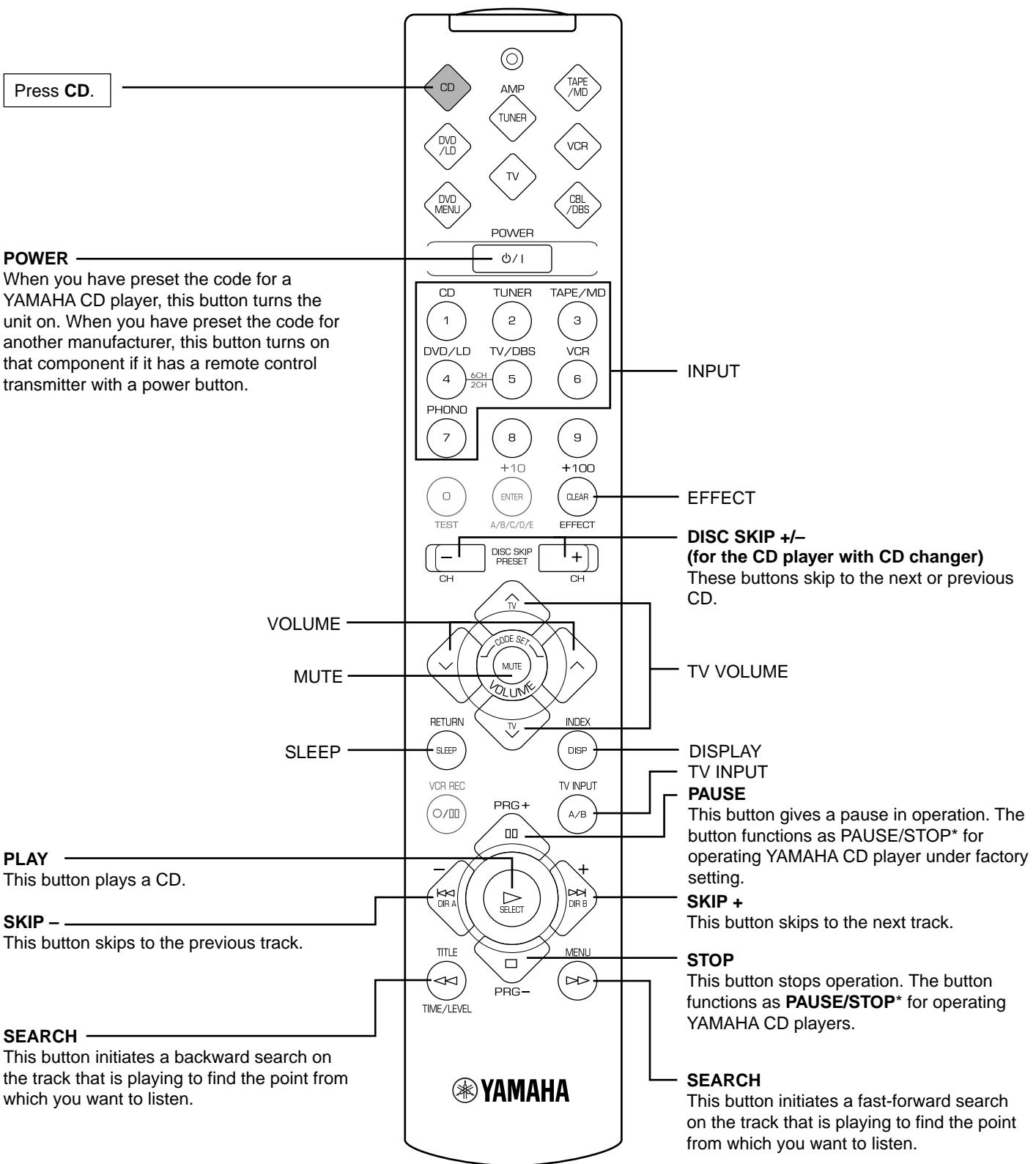

* PAUSE/STOP function ... Press once to give a pause an operation and once more to stop operation.

Note
TV VOLUME and TV INPUT function if you have preset the code for your TV.

The lightly marked buttons do not function. Please refer to the owner's manual for details of each component.

DVD/LD MODE

Press **DVD/LD**.

POWER

(DVD) When you have preset the code for a YAMAHA DVD player, this button turns the unit on. When you have preset the code for another manufacturer, this button turns on that component if it has a remote control transmitter with a power button.

(LD) When you have preset the code for a YAMAHA LD player, this button turns the unit on. When you have preset the code for another manufacturer, this button turns on that component if it has a remote control transmitter with a power button.

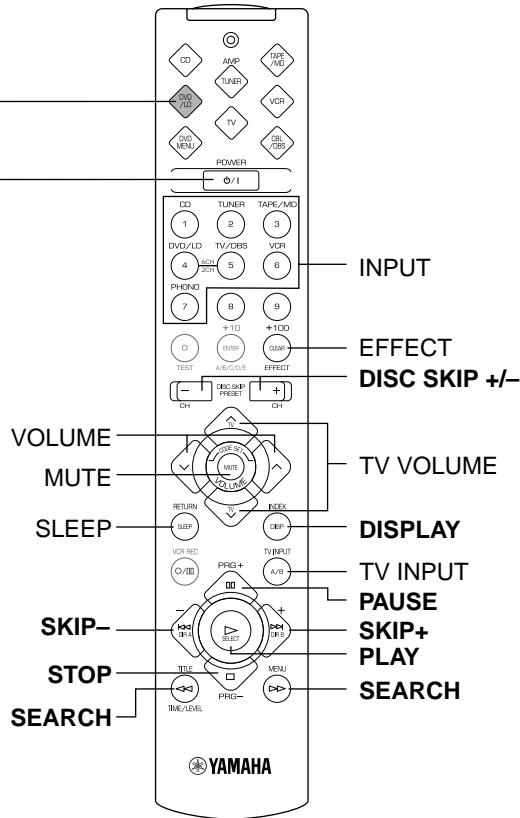

Note

TV VOLUME and **TV INPUT** function if you have preset the code for your TV.

DVD MENU MODE

Press **DVD MENU**.

POWER

When you have preset the code for a YAMAHA DVD player, this button turns the unit on. When you have preset the code for another manufacturer, this button turns on that component if it has a remote control transmitter with a power button.

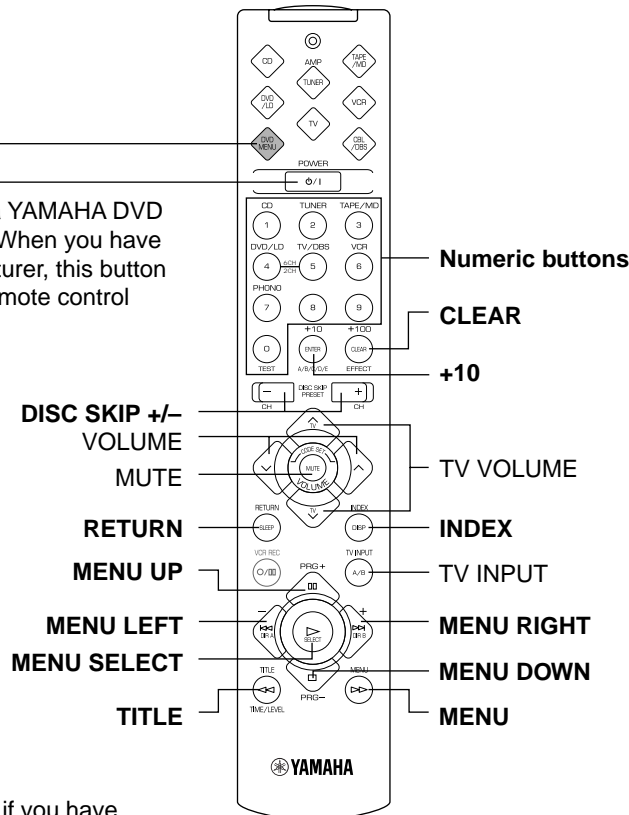

Note

TV VOLUME and **TV INPUT** function if you have preset the code for your TV.

The lightly marked buttons do not function. Please refer to the owner's manual for details of each component.

■ VCR MODE

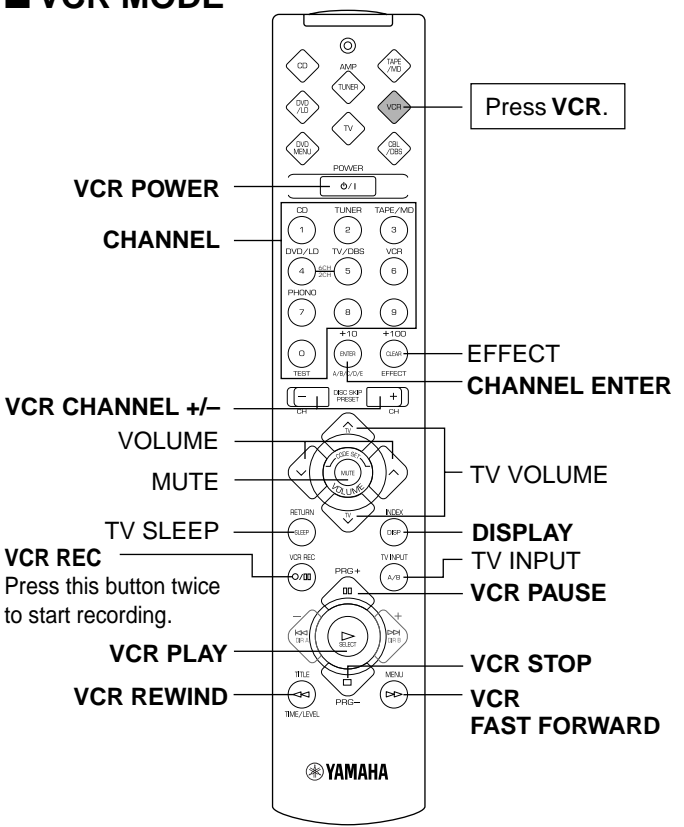

Note
TV VOLUME, TV INPUT and TV SLEEP function if you have preset the code for your TV.

■ TV MODE

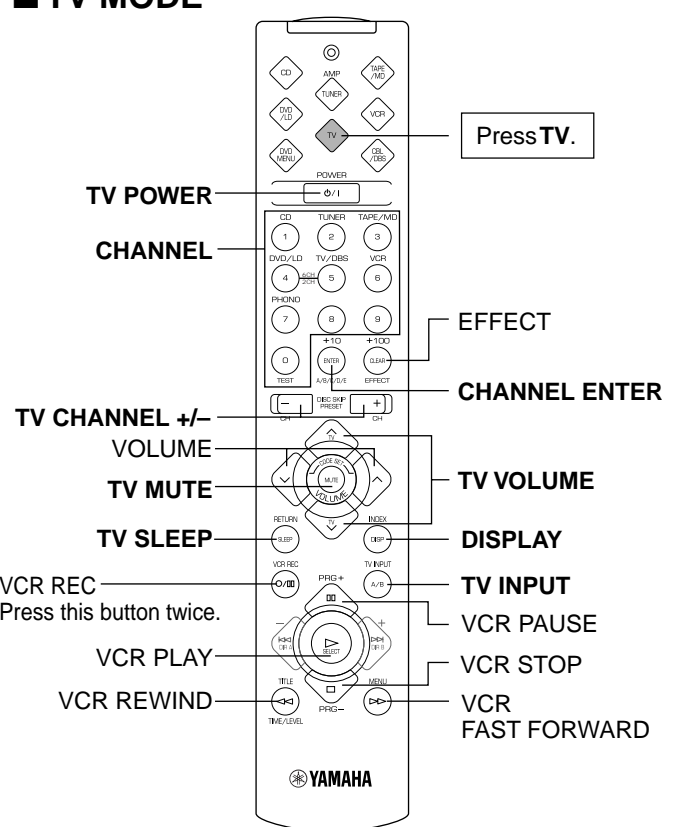

Note
You can control your VCR if you have preset the code for it.

■ CBL/DBS MODE

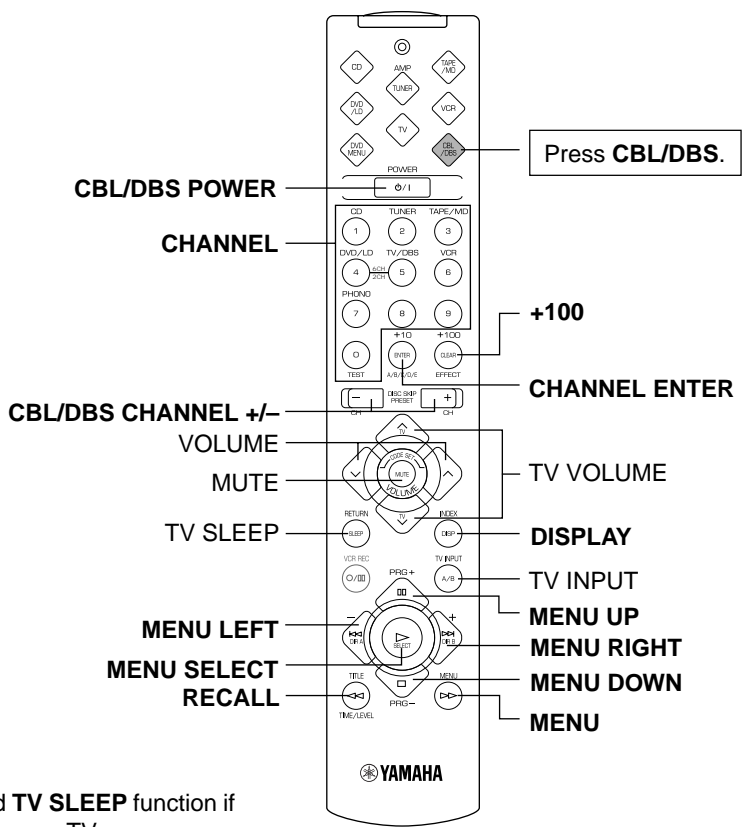

Note
TV VOLUME, TV INPUT and TV SLEEP function if you have preset the code for your TV.

USING DIGITAL SOUND FIELD PROCESSOR (DSP)

This unit incorporates a sophisticated, multi-program digital sound field processor. The processor allows you to electronically expand and change the shape of the audio sound field from both audio and video sources, creating a theater-like experience in your listening room. You can create an excellent audio sound field by selecting a suitable sound field program (this will, of course, depend on what you will be listening to), and adding desired adjustments.

In addition, this unit incorporates a Dolby Pro Logic Surround decoder for multi-channel sound reproduction of sources encoded with Dolby Surround. The operation of the Dolby Pro Logic Surround decoder can be controlled by selecting a corresponding DSP program including a combined operation of Yamaha DSP and Dolby Pro Logic Surround.

Brief Overview of Digital Sound Field Programs

The following list gives you a brief description of the sound fields produced by each of the DSP programs. Keep in mind that most of these are precise digital recreations of actual acoustic environments. The data for these sound fields was recorded at actual locations using sophisticated sound field measurement equipment.

Note

The channel level balance between the left and right rear effect speakers may vary depending on the sound field you are listening to. This is due to the fact that most of these sound field recreations are actual acoustic environments.

PROGRAM	FEATURE
<input checked="" type="checkbox"/> PRO LOGIC	This program is used for playback of sources encoded with Dolby Surround. The application of a sophisticated digital signal processing system reduces crosstalk and directs or steers the sound source more smoothly and precisely, as compared to conventional types.
<input checked="" type="checkbox"/> PRO LOGIC ENHANCED	This program is also used for playback of sources encoded with Dolby Surround. Enhancing the "Normal" Dolby Pro Logic, the DSP technology simulates the multi-surround speaker systems of a 35 mm movie theater. This effect creates a wide surround sound field, and expands the sound stage with an improved presence image. This program is used for musical based movies, as well as drama and comedy based movies.
CONCERT VIDEO	This program is effective for music videos and gives excellent depth and clarity for vocals. For opera, the orchestra and stage are ideally recreated, letting you feel as if you were in an actual concert hall.
MONO MOVIE	This program is designed specifically to enhance mono source programs. Compared to a strictly mono setting, the sound image created in this mode is wider and slightly forward of the speaker pair, lending an immediacy to the overall sound. It is particularly effective when used with old mono movies, news broadcasts and dialog.
TV SPORTS	This program is furnished with a tight sound field in which the sound will not spread excessively on the front side, but the rear surround side produces a dynamic sound expansion. This program is the most suitable for sports programs.
DISCO	This program recreates the acoustic environment of a lively disco in the heart of a very lively city. The sound is dense and highly concentrated. It is also characterized by a high-energy, "immediate" sound.
ROCK CONCERT	This program is ideally suited for rock music. You will experience a very dynamic or lively sound field.
CONCERT HALL	In this program, the center will appear to be deep behind the main speakers, creating an expansive large hall ambience. Orchestra and opera music are suited for this sound field.

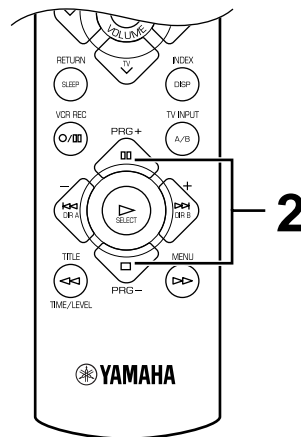
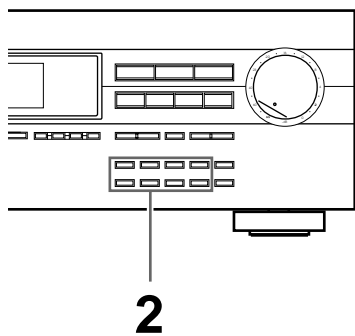

Press the component selector button **AMP<TUNER>** on the remote control transmitter.

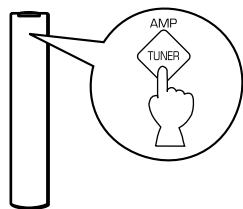

1 Follow steps 1 to 6 of the procedure shown in **"TO PLAY A SOURCE"** on page 22.

2 Select a program that is suitable for the source.

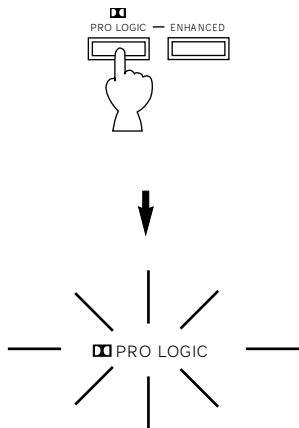

The selected mode indicator lights in the display.

3 If desired, adjust the delay time and the output level of each speaker. (For details, refer to the descriptions on pages 38 and 39.)

Notes

- Program selection can be made to individual input sources. Once you select a program, it is linked with the input source selected at that time. So, the next time you select the input source, the same program is automatically recalled.
- If you prefer to cancel the DSP, press the **EFFECT** button. The sound will be the normal 2-channel stereo without surround sound effect.
- When **CONCERT VIDEO**, **MONO MOVIE**, **TV SPORTS**, **DISCO**, **ROCK CONCERT** or **CONCERT HALL** is selected, no sound is heard from the center speaker.
- When a monaural sound source is played with **DOLBY PRO LOGIC** or **DOLBY PRO LOGIC ENHANCED**, no sound is heard from the rear speakers.
- When this unit's Dolby Pro Logic Surround decoder is used, if the main-source sound is considerably altered by overadjustment of the **BASS** or **TREBLE** control, the relationship between the center and rear channels may produce an unnatural effect.
- To select a DSP program on the remote control transmitter, first turn the DSP on so that a program name lights up in the display by pressing the **EFFECT** button. Next, select a desired DSP program by pressing the **PRG+** or **PRG-** operation buttons.

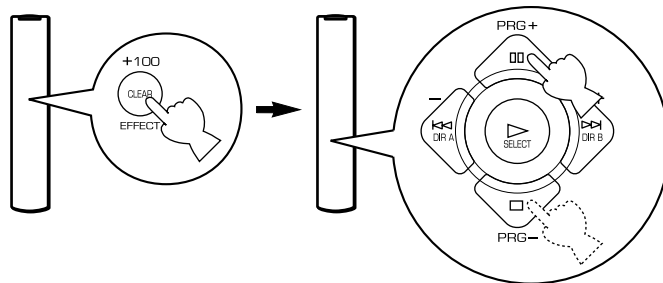

Adjustment of the CENTER LEVEL

If desired, you can adjust the sound output level of the center speaker even if the output level is already set in “**SPEAKER BALANCE ADJUSTMENT**” on page 19.

- 1 Press repeatedly until “CENTER” appears on the display.

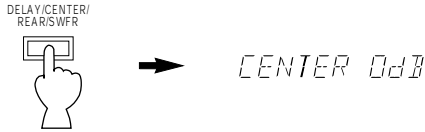

- 2 Pressing and holding the “+” or “-” side of the **TIME/LEVEL** button continuously changes the level value. The value stops changing momentarily at the preset point (0 dB).

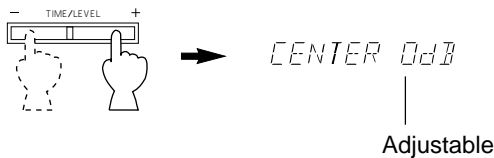

Control range: MIN, -20 to +10 dB

Notes

- This adjustment can be made only when the digital sound field program **DOLBY PRO LOGIC** or **DOLBY PRO LOGIC ENHANCED** is selected.
- Once the output level is adjusted, the level value will be the same in all of the digital sound field programs.

Adjustment of the REAR LEVEL

If desired, you can adjust the sound output level of the rear speakers even if the output level is already set in “**SPEAKER BALANCE ADJUSTMENT**” on page 19.

- 1 Press repeatedly until “REAR” appears on the display.

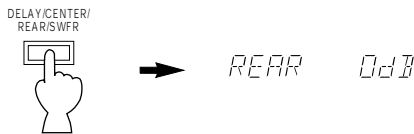

- 2 Pressing and holding the “+” or “-” side of the **TIME/LEVEL** button continuously changes the level value. The value stops changing momentarily at the preset point (0 dB).

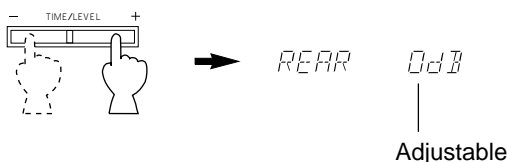

Control range: MIN, -20 to +10 dB

Notes

- This adjustment can be made only when the built-in digital sound field processor is on.
- Once the output level is adjusted, the level value will be the same in all the digital sound field programs.

Adjustment of DELAY TIME

You can adjust the time difference between the beginning of the sound from the main speakers and the beginning of the effect sound from the rear speakers.

The larger the value, the later the effect sound is generated. This adjustment can be made to all programs individually.

PRO LOGIC	: from 15 to 30 milliseconds (Preset value: 20 milliseconds)
PRO LOGIC ENHANCED	: from 15 to 30 milliseconds (Preset value: 20 milliseconds)
CONCERT VIDEO	: from 1 to 100 milliseconds (Preset value: 28 milliseconds)
MONO MOVIE	: from 1 to 100 milliseconds (Preset value: 20 milliseconds)
TV SPORTS	: from 1 to 50 milliseconds (Preset value: 45 milliseconds)
DISCO	: from 1 to 100 milliseconds (Preset value: 14 milliseconds)
ROCK CONCERT	: from 1 to 100 milliseconds (Preset value: 17 milliseconds)
CONCERT HALL	: from 1 to 100 milliseconds (Preset value: 30 milliseconds)

- 1 Press repeatedly until "DELAY" appears on the display.

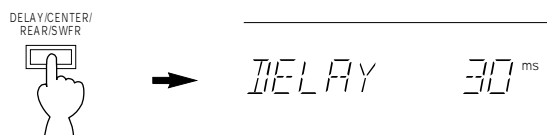

- 2 Pressing and holding the "+" or "-" side of the **TIME/LEVEL** button continuously changes the value. The value stops changing momentarily at the preset point.

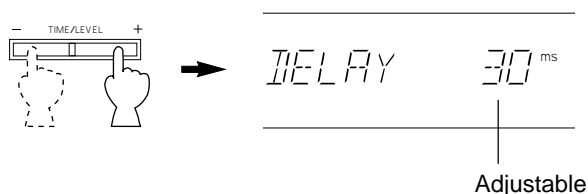

Notes

- When the **TIME/LEVEL** button is pressed, sound is momentarily interrupted.
- Adding too much delay will cause an unnatural effect with some sources.
- To adjust the delay time of the selected DSP program on the remote control transmitter, press the + and – operation buttons.

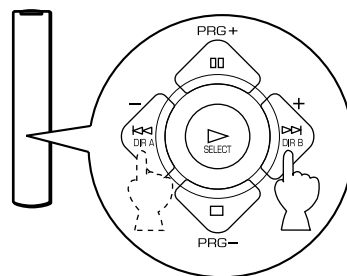

Note

The values of the delay time, center level, rear level and subwoofer output level you set will remain memorized even when this unit is in the standby mode.

However, if the power cord is kept disconnected for more than one week, these values will be automatically changed back to the original factory settings.

SETTING THE SLEEP TIMER

If you use the SLEEP timer of this unit, you can have this unit automatically put in the standby mode after a set period of time. When you want to go to sleep while enjoying a broadcast or other desired input source, this timer function is helpful.

Notes

- The SLEEP timer can be controlled only with the remote control transmitter.
- The components on which the SLEEP timer is effective are the sources connected to the **SWITCHED AC OUTLET(S)** on the rear panel of this unit.

To set the SLEEP time

1

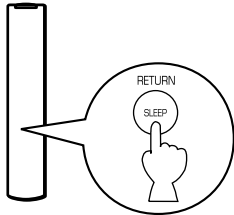

Press repeatedly to select the desired SLEEP time.



Indicates the SLEEP time.

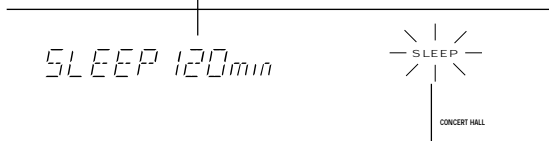

Lights up.

Whenever the **SLEEP** button is pressed, the SLEEP time will change as follows.

(Minutes)

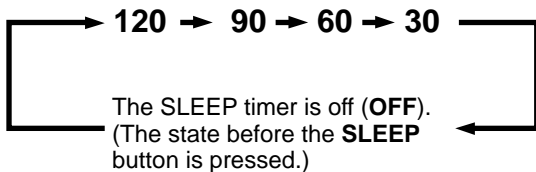

After a while, the display returns to the indication displayed before the SLEEP timer was set.

2

The unit will be turned into the standby mode automatically at the selected SLEEP time.

To cancel the selected SLEEP time

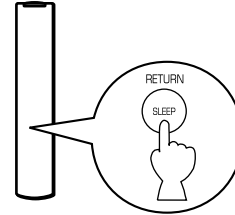

Press repeatedly until "SLEEP OFF" appears in the display. (It will soon disappear and the "SLEEP" indicator will go off from the display.)

Note

The SLEEP timer setting can also be canceled by putting this unit into the standby mode with the **STANDBY/ON** switch on the front panel (or the **POWER** button on the remote control transmitter) or disconnecting the power plug of this unit from the AC outlet.

SETUP CODES

Presetting the remote control transmitter

Perform the presetting procedure for each component you want to control with the remote control transmitter.

Note

If your component does not respond to any of the codes listed for the manufacturer, use the original remote control transmitter that was supplied with the component.

To control your components (MD recorder, DVD player, TV, etc.)

1. Turn on the component to be used.
2. Press the component selector button that matches the component to be controlled (TAPE/MD, DVD/LD, TV, etc.).

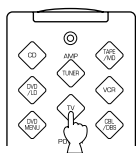

3. Press both **VOLUME** buttons (^ v) at the same time for about four seconds so that the indicator flashes twice.

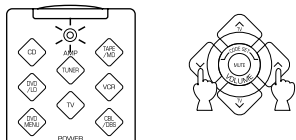

4. Use the numeric buttons to enter the four-digit manufacturer's code for the component to be used. Make sure that the indicator flashes twice. If the indicator does not flash, repeat step 3 and re-enter the code.

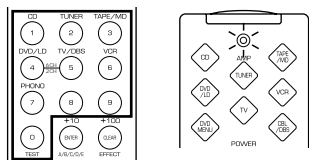

5. Press **POWER** (or any other button) on the remote control transmitter to check if you have preset the code correctly. If the component cannot be controlled by the remote control transmitter, try entering another code for the same manufacturer.

To use a second (and third) VCR

You can control a second (and/or third) VCR in the CBL/DBS and DVD MENU modes if a CBL (or DBS) or DVD player is not being used.

If you want to control a second (and/or third) VCR in the DVD MENU mode, you must preset the code for an LD player in that mode.

1. Turn on the VCR to be used.
2. Press the component selector button **CBL/DBS** or **DVD MENU**.

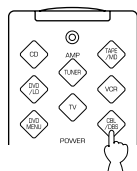

3. Press both **VOLUME** buttons (^ v) at the same time for about four seconds so that the indicator flashes twice.

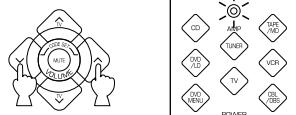

4. Use the numeric buttons to enter the four-digit code for the second (or third) VCR. Make sure that the indicator flashes twice. If the indicator does not flash, repeat step 3 and re-enter the code.

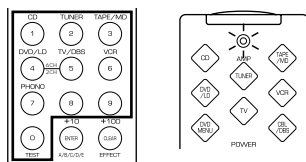

5. Press **POWER** (or any other button) on the remote control transmitter to check if you have preset the code correctly. If the VCR cannot be controlled by the remote control transmitter, try entering another code for the same manufacturer.

Returning to the factory-set codes

To return all components to the factory-set codes, follow these steps.

1. Press a component selector button other than **AMP<TUNER>**.
2. Press both **VOLUME** buttons (^ v) for about four seconds at the same time so that the indicator flashes twice.
3. Enter the code number "9990".
4. Make sure that the indicator flashes twice.

To return each component to the factory-set codes, follow these steps.

1. Press the component selector that matches the component to be returned to the factory-set codes.
2. Press both **VOLUME** buttons (^ v) at the same time for about four seconds so that the indicator flashes twice.
3. Enter the code number "0000".
4. Make sure that the indicator flashes twice.

The following codes are preset by the factory.

Factory-set codes

Component selector	Component	Code
TV	TV	0101
CBL/DBS	DBS tuner	0006
VCR	VCR	0002
DVD/LD	DVD player	0008 YAMAHA
CD	CD player	0005 YAMAHA
TAPE/MD	Tape deck	0004 YAMAHA

We recommend that you write all code numbers you have preset on the "Quick Reference Card".

TROUBLESHOOTING

If the unit fails to operate normally, check the following points to determine whether the fault can be corrected by the simple measures suggested. If it cannot be corrected, or if the fault is not listed in the SYMPTOM column, disconnect the power cord and contact your authorized YAMAHA dealer or service center for help.

	SYMPTOM	CAUSE	REMEDY
Amplifier	The unit fails to turn on when the STANDBY/ON switch is pressed, or turns into the standby mode suddenly soon after the power is turned on.	Power cord is not plugged in or is not completely inserted.	Firmly plug in the power cord.
		The IMPEDANCE SELECTOR switch on the rear panel is not set to the right or the left end firmly.	Set the switch to the right or the left end firmly.
	It happens that this unit does not work normally.	There is an influence of strong external noise (lightning, excessive static electricity, etc.) or a misoperation on this unit while using this unit.	Turn this unit into the standby mode and disconnect the AC power cord from the AC outlet. After about 30 seconds, connect the power and operate this unit again.
	No sound or no picture.	Incorrect output cord connections.	Connect the cords properly. If the problem persists, the cords may be defective.
		Appropriate input source is not selected.	Select an appropriate input source with the input selector buttons.
		The SPEAKERS switches are not set properly.	Set the SPEAKERS switch which corresponds to the speakers to be used to the ON position.
		Speaker connections are not secure.	Secure the connections.
	The sound suddenly goes off.	The protection circuit has been activated because of short circuit etc.	Turn this unit into the standby mode, and then turn on to reset the protection circuit.
		The SLEEP timer has functioned.	Cancel the SLEEP timer function.
	Only one side speaker outputs the sound.	Incorrect setting of the BALANCE control.	Adjust it to the appropriate position.
		Incorrect cord connections.	Connect the cords properly. If the problem persists, the cords may be defective.
	Sound "hums".	Incorrect cord connections.	Firmly connect the audio plugs. If the problem persists, the cords may be defective.
		No connection from the turntable to the GND terminal.	Make the GND connection between the turntable and this unit.
	The volume level is low while playing a record.	The record is being played on a turntable with an MC cartridge.	The player should be connected to the unit through the MC head amplifier.
	The volume level cannot be increased, or sound is distorted.	The component connected to the REC OUT terminals of this unit is turned off.	Turn the power to the component on.
	No sound from the rear speakers.	The sound output level to the rear speakers is set to minimum.	Raise the sound output level to the rear speakers.
No sound from the center speaker.	The monaural sound source is played in DOLBY PRO LOGIC or DOLBY PRO LOGIC ENHANCED mode.	Select another program suitable for the monaural sound source.	
	The sound output level to the center speaker is set to minimum.	Raise the sound output level to the center speaker.	
FM stereo reception is noisy.	The center channel mode is in PHANTOM mode.	Select NORMAL or WIDE .	
	Incorrect sound field program selection.	Select the appropriate program.	
	Because of the characteristics of FM stereo broadcasts, this is limited to cases where the transmitter is too far away or the antenna input is poor.	Check the antenna connections. Try using a high quality directional FM antenna. Set the TUNING MODE button to the manual tuning mode.	
FM	There is distortion and clear reception cannot be obtained even with a good FM antenna.	There is multipath interference.	Adjust antenna placement to eliminate multipath interference.
	A desired station cannot be tuned in with the automatic tuning method.	The station is too weak.	Use the manual tuning method. Use a high quality directional FM antenna.
	Previously preset stations can no longer be tuned in.	This unit has been unplugged for a long period.	Repeat the presetting procedure.
AM	A desired station cannot be tuned in with the automatic tuning method.	Weak signal or loose antenna connections.	Tighten the AM loop antenna connections and rotate it for best reception. Use the manual tuning method.
	There are continuous crackling and hissing noises.	Noises will result from lightning, fluorescent lamps, motors, thermostats and other electrical equipment.	Use an outdoor antenna and a ground wire. This will help somewhat but it is difficult to eliminate all noise.
	There are buzzing and whining noises (especially in the evening).	A television set is being used nearby.	Relocate this unit away from the TV.
Remote control transmitter	The remote control transmitter does not work.	Direct sunlight or lighting (of an inverter type of fluorescent lamp etc.) is striking the remote control sensor of the main unit.	Change the position of the main unit.
		The batteries of this remote control transmitter are too weak.	Replace the batteries with new ones.
		The component to be controlled has not been selected.	Press the component selector which matches the component to be controlled.
		The proper manufacturer's code for the component to be controlled has not been set.	Try entering another code for the same manufacturer.
		The manufacturer's code has not been set properly.	Set the code again.
Others	The sound is degraded when listening with the headphones connected to the compact disc player or cassette deck that are connected with this unit.	This unit is in the standby mode.	Turn the power to this unit on.

SPECIFICATIONS

AUDIO SECTION

Minimum RMS Output Power per Channel (Power Amp. Section)
(When both channels are driven)

Main L, R	8 ohms, 20 Hz to 20 kHz, 0.04% THD	60 W + 60 W
Center	8 ohms, 20 Hz to 20 kHz, 0.04% THD	60 W
Rear L, R	8 ohms, 20 Hz to 20 kHz, 0.04% THD	60 W + 60 W

Minimum RMS Output Power per Channel (Power Amp. Section)
(When both channels are driven)

Main L, R	8 ohms, 1 kHz, 0.07% THD	70 W + 70 W
Center	8 ohms, 1 kHz, 0.07% THD	70 W
Rear L, R	8 ohms, 1 kHz, 0.07% THD	70 W + 70 W

Maximum Power (EIAJ) [China and General models only]
(When both channels are driven)

Main L, R	8 ohms, 1 kHz, 10% THD	95 W + 95 W
Center	8 ohms, 1 kHz, 10% THD	95 W
Rear L, R	8 ohms, 1 kHz, 10% THD	95 W + 95 W

Dynamic Power per Channel
(by IHF Dynamic Headroom measuring method)

Main L, R	8 ohms	80 W + 80 W
	6 ohms	100 W + 100 W
	4 ohms	120 W + 120 W
	2 ohms	145 W + 145 W

DIN Standard Output Power per Channel [Europe model only]

Main L, R	4 ohms, 1 kHz, 0.7% THD	100 W + 100 W
Center	4 ohms, 1 kHz, 0.7% THD	100 W
Rear L, R	4 ohms, 1 kHz, 0.7% THD	100 W + 100 W

Dynamic Headroom [U.S.A. and Canada models only]

8 ohms	1.55 dB
--------	---------

IEC Power [Europe model only]

Main L, R	8 ohms, 1 kHz, 0.04% THD	65 W + 65 W
-----------	--------------------------	-------------

Power Band Width

Main L, R	8 ohms, 30 W, 0.1% THD	10 Hz to 50 kHz
-----------	------------------------	-----------------

Damping Factor (SPEAKERS A)

Main L, R	8 ohms, 20 Hz to 20 kHz	60 or more
-----------	-------------------------	------------

Input Sensitivity/Impedance

PHONO (MM)	2.5 mV/47 k-ohms
CD/TAPE-MD/DVD-LD/TV-DBS/VCR	150 mV/47 k-ohms
6CH DISCRETE INPUT (EXTERNAL DECODER)	
MAIN L/R	150 mV/47 k-ohms
CENTER	150 mV/40 k-ohms
REAR L/R	150 mV/40 k-ohms
SUBWOOFER	150 mV/40 k-ohms

Maximum Input Signal

PHONO (MM)	
1 kHz, 0.1% THD	100 mV or more
CD/TAPE-MD/DVD-LD/TV-DBS/VCR (EFFECT ON)	
1 kHz, 0.5% THD	2.2 V or more

Output Level/Impedance

REC OUT	150 mV/2.7 k-ohms
SUBWOOFER (EFFECT OFF)	5 V/1.2 k-ohms

Headphone Jack Rated Output Level/Impedance

(1 kHz, 8 ohms, 150 mV)	0.43 V/ 330 ohms
-------------------------	------------------

Frequency Response (20 Hz to 20 kHz)

CD/TAPE-MD/DVD-LD/TV-DBS/VCR	0 ± 0.5 dB
------------------------------	------------

RIAA Equalization Deviation

PHONO (MM)	0 ± 0.5 dB
------------	------------

Total Harmonic Distortion (20 Hz to 20 kHz)

PHONO (MM) to REC OUT	
1 V	0.02% or less
CD/TAPE-MD/DVD-LD/TV-DBS/VCR (EFFECT OFF) to SP OUT	
30 W/8 ohms	0.025% or less

Signal-to-Noise Ratio (IHF-A Network)

PHONO (MM) to REC OUT (5 mV Input Shorted)	
[U.S.A., Canada, China, and General models]	86 dB or more
[Australia, U.K., and Europe models]	81 dB or more
CD/TAPE-MD/DVD-LD/TV-DBS/VCR to MAIN SP OUT	
(150 mV Input Shorted, EFFECT OFF)	96 dB or more

Residual Noise (IHF-A Network)

MAIN L/R to SP OUT	150 μV or less
--------------------	----------------

Channel Separation (Vol. -30 dB, EFFECT OFF)

PHONO	
(Input Shorted, 1 kHz/10 kHz)	60 dB or more/55 dB or more
CD/TAPE-MD/DVD-LD/TV-DBS/VCR	
(Input 5.1 k-ohms shorted, 1 kHz/10 kHz)	60 dB or more/45 dB or more

Tone Control Characteristics

BASS: Boost/cut	±10 dB, 50 Hz
Turnover Frequency	350 Hz
TREBLE: Boost/cut	±10 dB, 20 kHz
Turnover Frequency	3.5 kHz

Filter Characteristics

Subwoofer (L.P.F.)	fc = 150 kHz, 6 dB/oct.
--------------------	-------------------------

VIDEO SECTION

Video Signal Level	1 Vp-p/75 ohms
Maximum Input Level	1.5 Vp-p or more
Signal-to-Noise Ratio	50 dB or more
Monitor Output Frequency Response	5 Hz to 10 MHz, -3 dB

FM SECTION

Tuning Range	
[U.S.A. and Canada models]	87.5 to 107.9 MHz
[China and General models]	
(frequency step 100 kHz)	87.5 to 108.0 MHz
(frequency step 50 kHz)	87.50 to 108.00 MHz
[Australia, U.K., and Europe models]	87.50 to 108.00 MHz

50 dB Quieting Sensitivity (S/N 50 dB, 1 kHz, 100% Mod.)

[U.S.A., Canada, China and General models only]	
IHF, Mono	1.6 μ V
IHF, Stereo	23 μ V

Usable Sensitivity (75 ohms)

[Australia, U.K., and Europe models only]	
DIN, Mono (S/N 26 dB)	0.9 μ V
DIN, Stereo (S/N 46 dB)	28 μ V

Alternate Channel Selectivity (\pm 400 kHz)

[U.S.A., Canada, China and General models only]	75 dB
---	-------

Selectivity (two signals, 40 kHz Dev. \pm 300 kHz)

[Australia, U.K., and Europe models only]	55 dB
---	-------

Signal-to-Noise Ratio (DIN-Weighted, 40 kHz Dev.)

[Australia, U.K., and Europe models only]	
Mono/Stereo	75 dB/69 dB

Signal-to-Noise Ratio (IHF)

[U.S.A., Canada, China and General models only]	
Mono/Stereo	81 dB/75 dB

Harmonic Distortion

Mono/Stereo (1 kHz)	0.1%/0.2%
---------------------------	-----------

Stereo Separation (1 kHz)

48 dB

Frequency Response

(20 Hz to 15 kHz)	0 \pm 1 dB
-------------------------	--------------

Output Level

[Australia, U.K., and Europe models]	
(40 kHz Dev., 1 kHz)	550 mV
[U.S.A., Canada, China and General models]	
(100% mod., 1 kHz)	550 mV

Antenna Input

75 ohms unbalanced

AM SECTION

Tuning Range

[U.S.A. and Canada models]	530 to 1710 kHz
[China and General models]	
(frequency step 10 kHz)	530 to 1710 kHz
(frequency step 9 kHz)	531 to 1611 kHz
[Australia, U.K., and Europe models]	531 to 1611 kHz

Usable Sensitivity

300 μ V/m

Output Level

(30% mod., 1 kHz)	150 mV
-------------------------	--------

Signal-to-Noise Ratio

52 dB

Antenna Input

Loop antenna

GENERAL

Power Supply

[U.K. and Europe models]	AC 230 V, 50 Hz
[U.S.A. and Canada models]	AC 120 V, 60 Hz
[Australia model]	AC 240 V, 50 Hz
[China model]	AC 220 V, 50 Hz
[General model]	AC 110/120/220/240 V, 50/60 Hz

Power Consumption

[U.K., Europe, China, Australia and General models]	260 W
[U.S.A. model]	240 W
[Canada model]	260 W/340 VA

Maximum Power Consumption (10% THD, When 5 channels are driven)

[General model only]	630 W
----------------------------	-------

AC Outlets

2 SWITCHED OUTLETS

[Europe, Canada, U.S.A., China and General models]	
.....	100 W max. total

1 SWITCHED OUTLET

[U.K. and Australia models]	100 W max. total
-----------------------------------	------------------

Dimensions (W x H x D)

435 x 151 x 391 mm

(17-1/8" x 5-15/16" x 15-3/8")

Weight

10.5 kg (23 lbs. 2 oz.)

Accessories

AM loop antenna
Indoor FM Antenna
75-ohm/300-ohm antenna adapter [U.K. model only]
Antenna adapter [U.S.A. and Canada models only]
Remote control transmitter
Batteries

Specifications are subject to change without notice.

**LIST OF MANUFACTURER'S CODES
LISTES DES CODES FABRICANT**

TV					
A-Mark	1161	Dansai	1001	Ima	1051
A Tandy	0941	Daytron	0941, 1031	Indiana	1001
Abex	1151	Decca	0271, 1001	Infinity Reference	0101
Admira	1141	Dixi	0331, 1001, 1071	Interfunk	1001
Adventura	1131	Dumont	0891, 1031	ITT	0611
Aiko	1121	Dynatech	0881	Janeil	1131
Akai	0331, 1101, 1111	Electroband	0951, 1011	JBL	0101
Alba	0431	Electrohome	0941	JCB	0951
Alleron	1091	Electron	0941	Jensen	0311
Ambassador	1081	Elin	1001	Jinxing	1531, 1541, 1551, 1561, 1571, 1621, 1631, 1641, 1651, 1691, 1731
Amstrad	0481, 1081	Elta	0331	JVC	0261, 0281, 0641, 0651, 0661, 0841
Anam	0251, 1041, 1051, 1061, 1071	Emerson	0001, 0021, 0061, 0071, 0081, 0091, 0111, 0811, 0821, 0831, 0841, 0851, 0861, 0871, 0901, 0921, 0941, 0981, 1011, 1031, 1051, 1081, 1091	Kawasho	0901
Anam National	1041	Envision	0361, 1111	Kaypani	1021
AOC	0361, 1021, 1031, 1111, 1161	Erres	1001	Kenwood	0361, 1031, 1111
Archer	1161	Etron	0331	Kloss	0631, 0721, 1131
Audiosonic	1001	Ferguson	1001	KTV	0921, 0941, 1011, 1051, 1111
Audiovox	1051, 1161	Finlux	1001	Leyco	1001
Awai	1481	Fisher	0171, 0801, 0981	Liesenk & Tter	1001
Bauer	0441	Formenti	0441	Lloytron	0941
Baur	1001	Formonti	1001	Loewe	1001
Beijing	1511, 1551, 1561	Fortress	1141	Logik	0991, 1771
Belcor	1031	Fujitsu	1091	Luxman	0351, 0971
Bell & Howell	0981, 0991	Funai	1051, 1091, 1341, 1361, 1411, 1451, 1501, 1521	Lxi	0101, 0621, 0761, 0861, 0981
Beon	1001	Futuretech	1051	Magnavox	0101, 0341, 0391, 0401, 0411, 0421, 0581, 0591, 0601, 0611, 0631, 0661, 0961, 1111
Bradford	1051	GE	0131, 0161, 0201, 0751, 0761, 0771, 0781, 0791, 0811, 0861, 1041	Majestic	0991
Brockwood	1031	GEC	0271, 1001	Marantz	0101, 0221, 0361, 1001, 1111
Broksonic	1161	Gemini	0391	Mark	1001
Bush	1001	Genexxa	0431	Matsui	0271, 0331, 1001
Candle	0351, 0361, 0961, 0971, 1111, 1131	Gibraltar	0891, 1031, 1111	Mediator	1001
Capehart	1021	GoldStar	0031, 0121, 0351, 0411, 0731, 0741, 0861, 0941, 0971, 1001, 1031, 1111, 1151	Megatron	0691, 0861, 1161
Carver	0101	Goodmans/Tashiko	0271, 0661, 1001	MEI	1011
Cathay	1001	Granada	1001	M Electronic	1001
Celebrity	0951	Grundig	1781, 1791, 1801, 1811, 1821, 1831, 1841, 1851, 1861, 1871, 1881	Memorex	0331, 0571, 0861, 0971, 0981, 0991, 1771
Centurion	0411	Gunpy	1051, 1091	Metz	1791, 1831, 1891, 1901, 1911, 1921, 1931, 1941
Changhong	1541, 1551, 1561, 1621	H/K	0721	MGA	0361, 0561, 0571, 0861, 1031, 1111
Citizen	0351, 0361, 0921, 0931, 0941, 0961, 0971, 1111, 1121, 1131	Hallmark	0861	Midland	0751, 0761, 0891, 0941, 1151
Clairtone	1011	Hanseatic	1001	Mitsubishi	0221, 0321, 0561, 0571, 0661, 0861, 1031, 1101, 1381
Clarivox	1001	Harvard	1051, 1061	Montgomery	1091
Concerto	0351, 0971	Hinari	1001, 1091	Motorola	1041, 1141
Conrowa	1751	Hitachi	0181, 0351, 0671, 0681, 0691, 0701, 0711, 0871, 0941, 0971, 1351	MTC	0351, 0361, 0881, 0931, 0971, 1011, 1031, 1111
Contec	0901, 0911, 1011, 1051	Hypson	1001	Multitech	0881, 1051
Corando	0941			NAD	0551, 0621, 0861
Craig	0251, 1051			NEC	0241, 0351, 0361, 0661, 0971, 1031, 1111, 1321, 1711
Crown	0941, 1051				
Curtis Mathes	0161, 0361, 0931, 0941, 0981, 1111				
CXC	1051				
Daewoo	0291, 0301, 0331, 0721, 0941, 1001, 1031, 1121, 1191, 1531, 1581, 1591, 1601				

Neckermann	1001	SBR	1001	Video Concept	1101
Nei	1001	Schneider	1001	Vidikron	0101, 0211
Nikkai	0271, 0431, 1001, 1151	Scimitsu	1031	Vidtech	0861, 1031
Nikko	0861, 1111, 1121	Scotch	0861	Viking	1131
Novabeam	0721	Scott	0831, 0861, 0941, 1031, 1051, 1091	Wards	0101, 0361, 0451, 0541, 0581, 0591, 0601, 0611, 0771, 0781, 0791, 0861, 0971, 0991, 1031, 1091, 1111, 1771
NTC	1121	Sears	0101, 0161, 0171, 0351, 0481, 0521, 0621, 0761, 0801, 0861, 0971, 0981, 1091	Watson	1001
Onwa	1051	Shanghai	1561, 1681	Xogego	1611, 1621, 1661, 1741, 1761
Optimus	0551	Sharp	0461, 0471, 0541, 0661, 0911, 0941, 1141, 1241, 1271	Yamaha	0221, 0361, 0571, 1031, 1111, 1141, 1381
Optonica	0541, 1141	Shogun	1031	Yoko	1001
Orion	0831, 1001	Signature	0991, 1771	Zenith	0011, 0041, 0891, 0991, 1771
Osaki	0271, 1151	Simpson	0581, 0961	Zonda	1161
Otto Versand	1001	Solavox	1151		
Panasonic	0101, 0191, 0251, 0751, 1041, 1311, 1371, 1431	Sonoko	1001		
Panda	1541, 1721	Sontec	1001		
Penny	0161, 0361, 0521, 0531, 0621, 0731, 0751, 0761, 0781, 0791, 0861, 0931, 0941, 1031, 1041, 1111, 1151, 1161	Sony	0371, 0451, 0661, 0841, 0951, 1281, 1441		
Peony	1561, 1621	Soundesign	0861, 0961, 1051, 1091		
Philco	0361, 0581, 0591, 0601, 0611, 0631, 0961, 1031, 1111	Soundwave	1001		
Philips	0101, 0401, 1001	Spectricon	1161		
Phonola	1001	Squareview	0481		
Pilot	0941, 1031, 1111	SSS	1031, 1051		
Pioneer	0511, 0551, 0871, 1331	Star-lite	1051		
Portland	0941, 1031, 1121	Suprem	0951		
Priceclub	0931	Supre-macy	1131		
Prism	0751	Surpa	0351, 0971		
Proscan	0761	Sylvania	0101, 0361, 0441, 0581, 0591, 0601, 0611, 0631, 0961, 1111		
Protech	1001	Symphonic	0481		
Proton	0501, 0861, 0941, 1021, 1161	Sysline	1001		
Pulsar	0891	Tandy	0271, 0431, 1141		
Pulser	1031	Tatung	0271, 0881, 1001, 1041, 1161		
Quasar	0251, 0751, 1041	Tcl	1561, 1631, 1701		
Quelle	1001	Technics	0751		
Radio Shack	0541, 0941, 1031, 1051, 1151	Techwood	0351, 0751, 0971		
Radiola	1001	Teknika	0101, 0351, 0571, 0931, 0941, 0961, 0971, 0991, 1031, 1051, 1091, 1121, 1131, 1771		
RCA	0051, 0141, 0151, 0181, 0411, 0491, 0531, 0761, 0771, 0871, 1031	Teletech	0331		
Realistic	0541, 0861, 0941, 0971, 0981, 1031, 1051, 1111, 1151	Tera	0501		
Rhapsody	1011	Thakral	1671		
R-line	1001	Thorm	1001		
Runco	0891, 1111	TMK	0351, 0861, 0971, 1081		
Saisho	0331, 1081	Toshiba	0381, 0521, 0621, 0661, 0931, 0981, 1301		
Sampo	0361, 0941, 1021, 1111, 1151	Tosonic	1011		
Samsung	0331, 0341, 0351, 0361, 0861, 0931, 0941, 0971, 1001, 1031, 1111, 1151, 1461	Totevision	0941		
Samsux	0941	Trical	0911		
Sanyo	0171, 0231, 0271, 0661, 0801, 0911, 0981, 1231, 1251, 1261	Universal	0781, 0791		
		Universum	1001		
		Vector Research	0361, 1111		
		Vestel	1001		
		Victor	0651, 1201, 1211, 1221		

CABLE

ABC	0256, 0376
Antronix	0136
Archer	0136, 0286
BBT	0076
Cabletime	0166
Cablevision	0196
Colour Voice	0306, 0346
Comtronics	0216, 0276
Eagle Comtronics	0276
Eastern	0066
Electricord	0206
Electus	0266
GE	0116, 0126
GEC Cable System	0196
Hamlin H5	0676
Hamlin H6	0666
Hamlin H6S	0656
Hamlin H8	0646
Hamlin H9	0636
Jerrold	0256
Jerrold 400L	0626
Jerrold 450L	0616
Jerrold 550	0606
Jerrold Osd Catv	0596
Jerrold Sprucer	0436
Magnavox/Philips	0416, 0426
Mamm	0296
Memorex	0386
Movie Time	0146, 0206
Northcoast	0016
NSC	0146
Oak	0106
Oak Sigma 450	0546
Oak Sigma 550	0536
Panasonic TZ 120/130	0476
Panasonic TZ 170/180	0446
Panasonic TZ140	0466
Panasonic TZ150/160	0456
Paragon	0386

Philips	0036, 0216, 0306, 0316, 0326, 0336, 0346
Pioneer	0006, 0086
Pioneer BR50	0846
Pioneer BR60/70/80/81/82	0696
Pioneer BR90	0556
Pulsar	0386
RCA Digital Satellite System	0396, 0406
Realistic	0136
Regency/Eastern	0686
Runco	0386
Samsung	0276
Scientific Atlanta 175/475	0576
Scientific Atlanta 75	0366, 0586
Scientific Atlanta 8650	0566
Signal	0276
SL Marx	0276
Spectavision	0236
Standard Components	0186
Starcom V	0256
Stargate	0276
Sylvania/Texscan	0376, 0496
Teknika	0176
Teleservice	0056
Teleview	0276
Texscan	0186, 0376
TFC	0026
Tocom	0226, 0356
Tocom 5503A	0526
Tocom 5503VIP/5507	0516
Tocom TC56	0506
Toshiba	0386
Tudi	0046
Unika	0136
Universal	0136, 0156, 0206, 0286
Videoway	0096
Viewstar	0216
Zenith	0246, 0386, 0486

DBS TUNER

Alpha Star	0826
Chaparral	0756
Echostar	0836
General Instrument	0776
HTS	0836
Hughes Network Systems	0816
Jerrold	0776, 0786
Panasonic	0806
Primestar	0776, 0786
RCA	0766
Sony	0796

VCR

A Tandy	0902
Adventura	0992
Aiko	0982
Aiwa	0992
Akai	0262, 0942, 0952, 0962, 0972
American High	0932
Amstrad	0992
ASA	0002, 0912
Asha	0922
Audio Dynamics	0202
Audiovox	0912
Beaumarck	0922
Bell & Howell	0902
Blaupunkt	0412
Broksonic	0872, 0882, 0892
Bush	0852
Calix	0912
Canon	0862, 0932
CCE	0852, 0982
Citizen	0912, 0982
Colt	0852
Craig	0832, 0842, 0852, 0912, 0922
Curtis Mathes	0662, 0822, 0932
Cybernex	0922
Daewoo	0802, 0812, 0982
DBX	0202
Dynatech	0472, 0992
Electrohome	0912
Electroponic	0912
Emerex	0792
Emerson	0072, 0132, 0142, 0152, 0162, 0172, 0182, 0192, 0212, 0702, 0712, 0722, 0732, 0742, 0752, 0762, 0772, 0782, 0872, 0882, 0892, 0912, 0952, 0992, 1072
Finlux	0002, 0992
Fisher	0682, 0692, 0842, 0902
Fuji	0672, 0932
Funai	0992
Garrard	0992
GE	0662, 0822, 0932
Go Video	0642, 0652
GoldStar	0082, 0632, 0912
Goodmans	0402
Gradiente	0992
Granda	0612, 0902
Grundig	0002
H/K	1082
Harley Davidson	0992
Harmon/Kardon	0632, 1082
Harwood	0752, 0852
Headquarter	0612
HI-Q	0842

Hinari	0852
Hitachi	0102, 0562, 0572, 0582, 0592, 0602, 0992
ITT	0942
JVC	0202, 0522, 0532, 0542, 0552
Kenwood	0202, 0542, 0612, 0632, 0902
KLH	0852
Kodak	0912, 0932
Lloyd	0992
Logik	0852
Luxor	0942
LXI	0022, 0912
Magnavox	0002, 0482, 0492, 0502, 0512, 0932
Magnin	0922
Marantz	0002, 0202, 0402, 0632, 0932
Marta	0912
Matsui	0722
Matsushita	0932
MEI	0222, 0932
Memorex	0232, 0242, 0472, 0512, 0612, 0842, 0902, 0912, 0922, 0932, 0992
MGA	0762, 0952
MGA Technology	0922
Minolta	0592, 0602
Mitsubishi	0452, 0462, 0542, 0762, 0952, 1082
Motorola	0472, 0932
MTC	0922, 0992
Multitech	0852, 0992
NAD	0442
NEC	0122, 0202, 0292, 0422, 0432, 0542, 0632
Nikko	0912
Noblex	0922
Olympus	0412, 0932
Optimus	0442, 0472, 0912
Optonica	0402
Orion	0212, 0722, 0742, 0772
Osaki	0912
Panasonic	0012, 0052, 0092, 0222, 0372, 0382, 0392, 0412, 0932
Penny	0202, 0432, 0602, 0632, 0692, 0912, 0922, 0932
Pentax	0592, 0602
Perdio	0992
Philco	0002, 0932
Philips	0002, 0282, 0402, 0492, 0932
Pilot	0912
Pioneer	0442, 0542
Proscan	1002, 1012, 1022, 1032, 1042, 1052, 1062
Pulsar	0512
Quarter	0612

Quartz	0272, 0612
Quasar	0382, 0392, 0932
Radio Shack	0912, 0992
Radix	0912
Randex	0912
RCA	0112, 0382, 0392, 0482, 0592, 0602, 0662, 0822, 0942
Realistic	0402, 0472, 0612, 0682, 0842, 0902, 0912, 0922, 0932, 0992
Ricoh	0352, 0362
Saisho	0212, 0582, 0722, 0732, 0742, 0772
Salora	0612, 0762
Samsung	0212, 0312, 0922, 0962
Sanky	0472, 0512
Sansui	0292, 0542, 0832
Sanyo	0242, 0612, 0842, 0902, 0922
SBR	0002, 0282
Schneider	0852
Scott	0342, 0712, 0762, 0872, 0882, 0892
Sears	0302, 0592, 0602, 0612, 0682, 0692, 0842, 0902, 0912, 0932
Sharp	0402, 0472
Shintom	0852
Shogun	0922
Singer	0852
Sony	0032, 0332, 0352, 0362, 0672, 0792, 0932
STS	0602
Sunpak	0352
Sylvania	0002, 0492, 0502, 0762, 0932, 0992
Symphonic	0992
Tandy	0992
Tashiko	0712, 0992
Teac	0992
Technics	0932
Teknika	0322, 0912, 0932, 0992
Telefunken	0252
TMK	0212, 0732, 0772, 0922
Toshiba	0062, 0302, 0342, 0622, 0682, 0712, 0762
Totevision	0912, 0922
Unitech	0922
Vector Research	0202, 0432, 0632
Victor	0532, 0542, 0552
Video Concepts	0202, 0432, 0632, 0952
Wards	0322, 0402, 0472, 0482, 0602, 0712, 0842, 0852, 0922, 0932, 0992
Yamaha	0202, 0632, 0762
Zenith	0042, 0362, 0512, 0672

DVD PLAYER

Akai	0108
JVC	0168
Onkyo	0128
Panasonic	0048
Philips	0188
Pioneer	0208, 0228
Samsung	0148
Sharp	0068
Sony	0028
Toshiba	0088
Yamaha	0008, 0048

LD PLAYER

Aiwa	0157
Denon	0147
Disco Vision	0017
Funai	0157
Hitachi (E)	0017
Kenwood	0087, 0107
Magnavox	0027
Marantz	0027
Mitsubishi	0137
NAD	0137
Panasonic	0077, 0177
Philips	0027
Pioneer	0037, 0017, 0137
RCA	0167
Realistic	0157
Sharp	0127
Sony	0047, 0057, 0117
Victor	0097
Yamaha	0007

CD PLAYER

Acoustic Research	1295
ADC	0025, 0065
Adcom	0205, 0255, 1015
ADS	0265
Aiwa	0295, 0945, 1035, 1055
Akai	0175, 0485, 0535
Alpine	1215, 1305
Audio-Technica	0545
BSR	0245, 0655, 0775
California Audio Lab	0055
Capetronic	1205
Carrera	0245
Carver	0285, 1135
Casio	0345
Crown	0185
Curtis Maths	0345
Denon	0275, 0875, 0885
Deual (E)	0505

Dynamic Bass (H)	0555
Emerson	0205, 0325, 1105
Eroica	1275
Fisher	0095, 0555, 0925, 1005
Garrard	0365
Genexxa	0305, 0325, 1105
GoldStar	1225, 1265, 1135, 1335
H/K	0105, 0175, 0465, 0995
Hitachi	0195, 0505, 0205, 0815
Inkel	0115, 0395
JVC	0315
Kenwood	0045, 0095, 0405, 0585, 0725, 0735, 0745, 0755, 0895
Kyocera	0025
Luxman	0075, 0425, 0675, 0705, 0715, 0985
Magnavox	0165, 0215, 0645, 0955
Marantz	0215, 0235, 0375, 0785, 1345
McIntosh	0355, 1085
MCS	0905, 1315
Memorex	0205, 0225, 0235, 0305, 0325, 1105
MGA	0135
Mission	0215
Mitsubishi	0135, 0445
MTC	1255
NAD	0035, 0615, 0685, 0695
Nakamichi	0125, 0435, 0515
NEC	0255, 0905, 0965
Nikko	0545, 1005
Onkyo	0155, 0455, 0495, 0805, 1155
Optimus	0225, 0245, 0555, 0595, 0845, 0855, 0865, 0895, 0935
Panasonic	0055, 0825, 1095, 1125
Penny	0905
Philips	0165, 0215
Pioneer	0305, 0935, 1045
Proton	0215, 1185
Quasar	0055
RCA	0205, 0915, 1115
Realistic	0205, 0225, 0235, 0325, 0555, 0845
Revox	1175
Rotel	0215
Saba Telecommander (E)	0505
SAE	0215
Samsung	1285
Sansui	0215, 0625, 0975, 1025, 1105
Sanyo	0145, 0555, 0635, 0765
Scott	0325, 1105
Sears	0345
Sharp	0235, 0665, 0895, 1065, 1075
Sherwood	0115, 0235, 0395, 0475
Siemens Garrard	1245
Signature	0175
Sontec	1165

Sony	0065, 0565, 0865, 1145
Staron	1235
STS	0025
Sylvania	0215
Symphonic	0335
Tandy	0305
Tangberg	1195
Teac	0235, 0335, 0385, 0525, 0795, 0835, 1355
Technics	0055, 0605, 1095
Techwood	1325
Telefunken (E)	0505
Thomson (E)	0505
Toshiba	0035, 0685
Vector Research	0065, 1135
Victor	0315
Wards	0175
Yamaha	0005, 0015, 0575, 1065

MD RECORDER

Yamaha	0024
--------	------

TAPE DECK

Aiwa	0094, 0214, 0224
Akai	0184
Carver	0094
Denon	0304
Fisher	0144
Garrard	0194, 0204
JVC	0274, 0284, 0294
Kenwood	0124, 0134, 0154, 0234, 0244, 0264
Magnavox	0094
Marantz	0094, 0344
Mitsubishi	0184
Onkyo	0364, 0374
Optimus	0034, 0064, 0204, 0334
Philips	0094
Pioneer	0034, 0044, 0064
Revox	0354
Sansui	0094, 0344
Sharp	0264
Sherwood	0334
Sony	0054, 0084, 0324
Teac	0194, 0254
Technics	0074, 0314
Victor	0294
Wards	0034
Yamaha	0004, 0014



YAMAHA ELECTRONICS CORPORATION, USA 6660 ORANGETHORPE AVE., BUENA PARK, CALIF. 90620, U.S.A.
YAMAHA CANADA MUSIC LTD. 135 MILNER AVE., SCARBOROUGH, ONTARIO M1S 3R1, CANADA
YAMAHA ELECTRONIK EUROPA G.m.b.H. SIEMENSSTR. 22-34, 25462 RELLINGEN BEI HAMBURG, F.R. OF GERMANY
YAMAHA ELECTRONIQUE FRANCE S.A. RUE AMBROISE CROIZAT BP70 CROISSY-BEAUBOURG 77312 MARNE-LA-VALLEE CEDEX02, FRANCE
YAMAHA ELECTRONICS (UK) LTD. YAMAHA HOUSE, 200 RICKMANSWORTH ROAD WATFORD, HERTS WD1 7JS, ENGLAND
YAMAHA SCANDINAVIA A.B. J A WETTERGRENS GATA 1, BOX 30053, 400 43 VÄSTRA FRÖLUNDA, SWEDEN
YAMAHA MUSIC AUSTRALIA PTY, LTD. 17-33 MARKET ST., SOUTH MELBOURNE, 3205 VIC., AUSTRALIA

YAMAHA CORPORATION
Printed in Malaysia © V338160